

---

BEOLAB 6000

---



---

---

*Your Beolab 6000 speakers are a set of very small, active loudspeakers. Their size, style and versatility make the Beolab 6000 ideal loudspeakers for all types of Audio/ Video and surround sound setups.*

*The use of magnetically shielded speaker units, the columnar design and the small dimensions all contribute to the unsurpassed versatility of Beolab 6000.*

*Owing to its sculptural design, the Beolab 6000 takes up very little floor space. The highly polished finish of the Beolab 6000 adopts the colour of its surroundings and enhances the beauty of your home while giving you musical experiences.*

*This guide describes how to assemble the Beolab 6000, where to place it and how to connect it to your Audio or Video system.*

- 5 *Assembling*
- 6 *Connections*
- 8 *Switching on and off*
- 9 *Maintenance*
- 10 *International guarantee*

### *Environmental information*

This Bang & Olufsen product was delivered in a packing made to protect and transport the product safely from the factory to your home.

In the design of our packing we use the most conserving and recyclable materials known today, and we constantly work to reduce any negative side effects our packing materials may have on the environment.

We observe any progress with great interest.

*Corrugated cardboard* Made of at least 45 % recycled material. The printing ink contains no heavy metals, and the box is reusable for paper production.

*Foamed plastic parts* Made without use of injurious inert gasses. Can be recycled or incinerated, liberating carbon dioxide and water. Usable for soil improvement in granular form.

*Plastic bags* All plastic parts are free of PVC and can be recycled or incinerated, liberating carbon dioxide and water.

*For the US market only:*

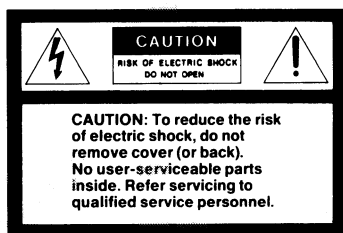

**WARNING:** To prevent fire or electric shock, do not expose this appliance to rain or moisture.



This symbol indicates that a dangerous voltage constituting a risk of electric shock is present within this unit.



This symbol indicates that there are important operating and maintenance instructions in the literature accompanying this unit.

### Column and base

It is easiest to assemble the base and the speaker column if the loudspeaker is lying on a table.

In order to protect the table and the column from being scratched, we recommend that you place the wrapping foam on the table first.

The parts required for assembling the Beolab 6000 are supplied with the loudspeakers:

- 1 Allen wrench
- 3 Screws (per speaker)

Hook the base plate onto the two guiding pins at the bottom of the speaker column (be careful not to drop the base plate!).

Insert the three screws and tighten them securely using the Allen wrench.

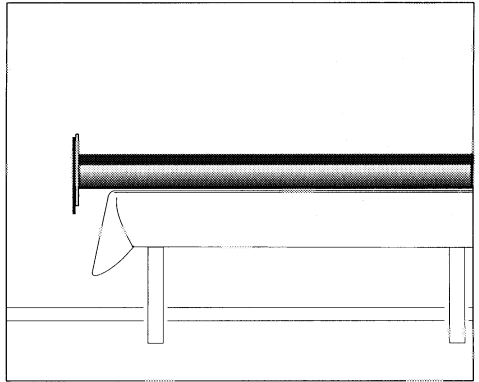

### Placement

The Beolab 6000 occupies very little space on the floor. In fact, it can be placed wherever it is most convenient for your room layout and for your preferred listening position.

*Remember though, when planning where to place them, that all speakers in a setup need connection to a mains outlet and that they are designed to be left on at all times!*

Once you, or your Bang & Olufsen dealer, have assembled the loudspeakers, they are ready for connection to your Audio or Video system and to the mains.

The socket panel is located at the bottom of the Beolab 6000. Use the illustrations on these pages and the graphics printed on the bottom plate for reference.

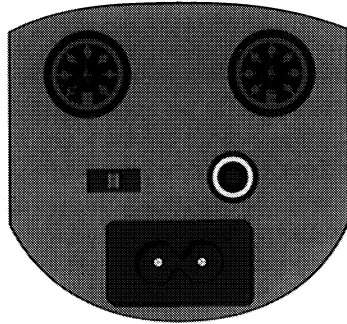

### Connection to Bang & Olufsen products

Connect the Beolab 6000 to the Beomaster/Beovision using the enclosed 8-pin Power Link cable. Plug one end into one of the Power Link sockets on the socket panel of the Beolab 6000 and the other end into either of the two Power Link sockets on the Beomaster/Beovision (please refer to your setting-up guide for the Beomaster/Beovision).

Once you have connected the loudspeakers to the Beomaster/Beovision, the switch marked **L•R•LINE** must be set to either L or R:

*L for the left-hand speaker*

*R for the right-hand speaker*

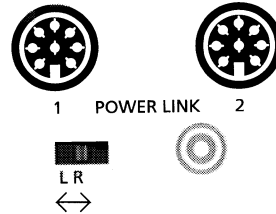

In order to avoid cables running from both loudspeakers to your Beomaster/Beovision, you may loop the signals through, using the second Power Link socket, as illustrated. If you wish, you can, of course, also connect one loudspeaker to each of the Power Link sockets on the Beomaster/Beovision.

You can connect more than one pair (as many as ten pairs, in fact) of Beolab 6000 loudspeakers to your system. You just have to run a Power Link cable from speaker to speaker. Remember though, to set the **L•R•LINE** switch to the proper position for the left- and right-hand speakers, respectively.

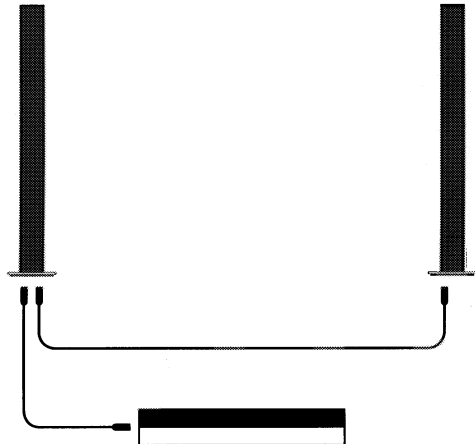

### Connection to non-Bang & Olufsen products

The phono socket marked LINE must be used instead of the Power Link sockets if the Beolab 6000 is to be connected to a non-Bang & Olufsen product (using e.g. a cable, part no. 6270595).

Once you have connected the Beolab 6000 to a non-Bang & Olufsen product, the switch marked L•R•LINE must be set to LINE, as indicated.

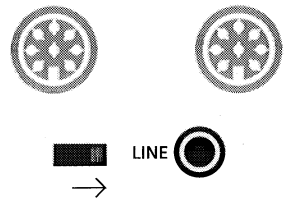

### Connection to the mains

Connect the Beolab 6000 to the mains using the enclosed mains lead.

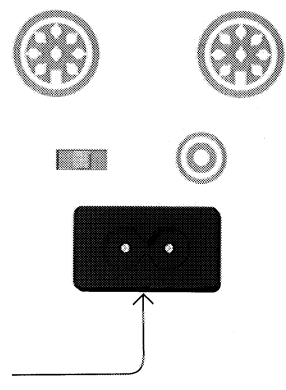

*Run the cables to and from the Beolab 6000 through the cable guides underneath the rear part of the speaker's bottom plate.*

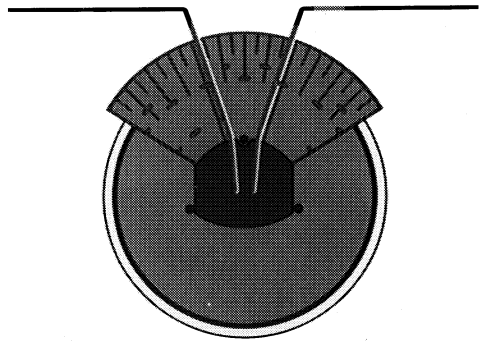

The moment you connect the Beolab 6000 to the mains, a tiny red light appears on the front, behind the cloth, indicating that the loudspeaker is on stand-by.

When you switch on your Bang & Olufsen audio system (or video system), the Beolab 6000 speakers switch on simultaneously.

The red stand-by light turns green, indicating that the loudspeaker is switched on.

When you switch off your system, or when you mute the sound, the red light appears immediately, indicating that the loudspeakers are switched off.

If the Beolab 6000 speakers are connected to a non-Bang & Olufsen system, via the phono sockets (LINE), they switch on when they receive a signal from the system. They switch off a few minutes after the signal has disappeared.

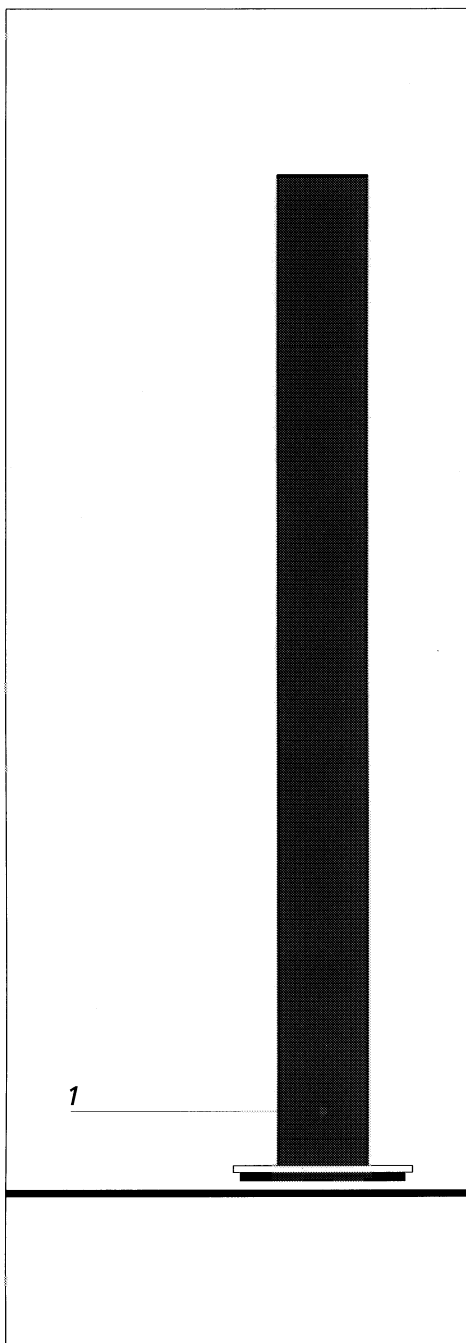

*1. The red stand-by light turns green when the loudspeakers are switched on*

Clean the Beolab 6000 loudspeakers using a soft, firmly wrung lint-free cloth which you have dipped in a solution of lukewarm water containing a few drops of mild detergent, for example a dish washing detergent.

**NOTE!**

*Never use alcohol or other solvents to clean the Beolab 6000 loudspeakers.*

**For the North American market only!**

This equipment generates and uses radio frequency energy and if not installed and used properly, that is, in strict accordance with the manufacturer's instructions, may cause interference to radio and television reception.

It has been type tested and found to comply with the limits for a Class B computing device in accordance with the specifications in Subpart J of Part 15 of FCC Rules, which are designed to provide reasonable protection against such interference in a residential installation.

However, there is no guarantee that interference will not occur in a particular installation. If this equipment does cause interference to radio or television reception, which can be determined by turning the equipment off and on, the user is encouraged to try to correct the interference by one or more of the following measures:

- Reorient the receiving antenna
- Relocate the computer with respect to the receiver
- Move the computer away from the receiver
- Plug the computer into a different outlet so that computer and receiver are on different branch circuits.

If necessary, the user should consult the dealer or an experienced radio/television technician for additional suggestions. The user may find the following booklet prepared by the Federal Communications Commission helpful:  
 "How to Identify and Resolve Radio-TV Interference Problems".

This booklet is available from the U.S. Government Printing Office, Washington, DC 20402, Stock No. 004-00345-4.

**Special note for the UK market**

The wires in the mains lead supplied with this apparatus are coloured in accordance with the following code:

Blue: Neutral  
 Brown: Live

As the colours of the wires in the mains lead may not correspond with the coloured markings identifying the terminals in your unit, proceed as follows:

- The wire which is coloured blue must be connected to the terminal which is marked with the letter N or coloured BLACK.
- The wire which is coloured brown must be connected to the terminal which is marked with the letter L or coloured RED.

Ensure that your equipment is connected correctly. If you are in any doubt, consult a qualified electrician.



This Bang & Olufsen product carries a guarantee against defects in workmanship and materials. The terms of the guarantee apply to the country of purchase but will be met by authorized Bang & Olufsen dealers in other countries. The guarantee period applying to the country of purchase takes priority over guarantee periods applying in other countries, even where differences exist.

In order to obtain service under this guarantee, a certificate stating the following information is required:

- Name of product and type number
- Serial number
- Date of purchase
- Guarantee period
- Dealer's or supplier's signature

If you intend to use the product in a country other than that in which it was bought, it may be necessary for you to have the product modified to suit the transmission system, or mains supply etc., used in the country you are moving to. We therefore recommend that you contact your Bang & Olufsen dealer before moving to another country. No costs incurred in this connection will be covered under the terms of the guarantee.

### List of distributors

<b>Australia</b>	Bang & Olufsen (Australia) Pty. Ltd. 136 Camberwell Road Hawthorn East 3123 Tel.: (03) 882-1256
<b>Austria</b>	Bang & Olufsen Ges. m.b.H. Hietzinger Kai 137A 1130 Wien Tel.: (0222) 878 09-0
<b>Belgium</b>	S.A. Bang & Olufsen N.V. Koningin Astridlaan 53 1780 Wemmel Tel.: (02) 460 81 91
<b>Canada</b>	Bang & Olufsen (Canada) A Division of Lenbrook Industries Ltd. 633 Granite Court Pickering, Ontario L1W 3K1 Tel.: (416) 831-6333
<b>Denmark</b>	Bang & Olufsen Denmark A/S Peter Bangsvej 15 DK 7600 Struer Tel.: 97 85 45 00
<b>Finland</b>	Oy Bang & Olufsen Ab Kuortaneenkatu 1 00520 Helsinki Tel.: (90) 146 4400
<b>France</b>	Bang & Olufsen France S.A. 4 Rue du Port 92110 Clichy Tel.: (01) 42 70 40 74
<b>Germany</b>	Bang & Olufsen Deutschland GmbH Rudolf-Diesel-Strasse 8 8031 Gilching b. München Tel.: (08105) 73-0
<b>Greece</b>	John Ul. Kyriacopoulos & Co 19, Amerikis Street 10671 Athens Tel.: (1)360.3534

<b>Hong Kong</b>	Bang & Olufsen(Hong Kong) Ltd. 10/F,Block C Sea View Estate 2-8 Watson Road Tel.: 887-2008	<b>Sweden</b>	Bang & Olufsen Svenska AB Box 1324 17125 Solna Tel.: 08-981340
<b>Italy</b>	DODI S.p.A. Via San Francesco d'Assisi, 31 20090 OPERA MI Tel.: 02/57 60 62 28	<b>Switzerland</b>	Bang & Olufsen AG Grindelstrasse 15 8303 Bassersdorf Tel.: 01-838 81 11
<b>Japan</b>	Bang & Olufsen of Japan Ltd. Kudan New Central Bldg.4-5 Kudan Kita 1-chome Chiyoda-ku, Tokyo 102 Tel.: (03) 3261-4431	<b>UK</b>	Bang & Olufsen UK Ltd Eastbrook Road Gloucester GL4 7DE Tel.: 0452-307377
<b>Netherlands</b>	Bang & Olufsen Nederland b.v. Postbus 111 1200 AC Hilversum Tel.: 035-260622	<b>USA</b>	Bang & Olufsen of America, Inc. 1150 Feehanville Drive Mount Prospect Illinois 60056 Tel.: 1 800 323-0378
<b>Norway</b>	Bang & Olufsen A/S Postbox 7034 3007 Drammen Tel.: 03-823790		
<b>Portugal</b>	Antonio Churro, Lda Rua D Joao V, 6a Porta 4 (ao Rato) 1200 Lisboa Tel.: 1-3830 945		
<b>Saudi Arabia</b>	Arabian Sounds & Lighs Osama Siraj Zahran Ests. P.O. Box 12-374 Jeddah 21473 Tel.: (2) 66 51 695		
<b>Singapore</b>	Bang & Olufsen Singapore Pte Ltd. 601 Sims Drive, 01-07 Pan 1 Complex Singapore 1438 Tel.: 74 87 262		
<b>Spain</b>	Bang & Olufsen España S.A. Ctra. Fuencarral-Alcobendas km 14,5 28100 Alcobendas (Madrid) Tel.: (1) 661-6575		