

# TC-K65

US Model  
 Canadian Model  
 AEP Model  
 UK Model  
 E Model



"Dolby" and the double-D symbol are the trade marks of Dolby Laboratories. Noise reduction system manufactured under license from Dolby Laboratories.

## STEREO CASSETTE DECK

### SPECIFICATIONS

- Power Requirements:** 220 V ac ~, 50/60 Hz (AEP model)  
 240 V ac ~, 50/60 Hz (UK model)  
 120 V ac ~, 60 Hz (US, Canadian model)  
 110, 120, 220 or 240 V ac ~, 50/60 Hz (E model)
- Power Consumption:** 26 W (AEP, UK model)  
 24 W (US, Canadian, E model)
- Dimensions:** Approx. 430 (w) x 130 (h) x 290 (d) mm  
 17 (w) x 5<sup>1</sup>/<sub>8</sub> (h) x 11<sup>1</sup>/<sub>2</sub> (d) inches  
 (AEP, US, UK, E model)  
 Approx. 460 (w) x 130 (h) x 290 (d) mm  
 18<sup>1</sup>/<sub>8</sub> (w) x 5<sup>1</sup>/<sub>8</sub> (h) x 11<sup>1</sup>/<sub>2</sub> (d) inches  
 (Canadian model)  
 including projecting parts and controls
- Weight:** Approx. 5.7 kg, 12 lb 8 oz (AEP, US, UK, E model)  
 Approx. 6.4 kg, 13 lb 14 oz (Canadian model)
- Recording System:** 4-track 2-channel stereo
- Fast-forward and Rewind Time:** Approx. 70 sec. (with C-60)

### SAFETY-RELATED COMPONENT WARNING!!

COMPONENTS IDENTIFIED BY SHADING AND MARK  ON THE SCHEMATIC DIAGRAMS, EXPLODED VIEWS AND IN THE PARTS LIST ARE CRITICAL TO SAFE OPERATION. REPLACE THESE COMPONENTS WITH SONY PARTS WHOSE PART NUMBERS APPEAR AS SHOWN IN THIS MANUAL OR IN SUPPLEMENTS PUBLISHED BY SONY.

ATTENTION AU COMPOSANT AYANT RAPPORT À LA SÉCURITÉ!

LES COMPOSANTS IDENTIFIÉS PAR UN TRAMÉ ET UNE MARQUE  SUR LES DIAGRAMMES SCHEMATIQUES, LES VUES EXPLOSÉES ET LA LISTE DES PIÈCES SONT CRITIQUES POUR LA SÉCURITÉ DE FONCTIONNEMENT. NE REMPLACER CES COMPOSANTS QUE PAR DES PIÈCES SONY DONT LES NUMÉROS SONT DONNÉS DANS CE MANUEL OU DES SUPPLÉMENTS PUBLIÉS PAR SONY.

Tape Transport Mechanism Type	TCM-100V3	
	Specification	Test Equipment
Forward Torque	28–43 g · cm (0.39–0.59 oz · inch)	Sony torque meter CQ102
Back Tension Torque	2.5–4.5 g · cm (0.04–0.06 oz · inch)	Sony torque meter CQ-102
Pinch Roller Pressure	280–380 g (10–13 oz)	Spring scale or tension gauge

– Continued on page 2 –

**SONY**  
**SERVICE MANUAL**

**Frequency Response:** DOLBY NR OFF

- With TYPE III cassette (Sony Fe-Cr)
  - 20–19,000 Hz
  - 30–17,000 Hz ( $\pm 3$  dB)
  - 30–17,000 Hz (DIN)(AEP, UK model)
- With TYPE II cassette (Sony CD- $\alpha$ ) . . . . . (AEP, UK model) (Sony EHF) . . . . . (US, Canadian, E model)
  - 20–18,000 Hz
  - 30–16,000 Hz ( $\pm 3$  dB)
  - 30–16,000 Hz (DIN) (AEP, UK model)
- With TYPE I cassette (Sony BHF) . . . . . (AEP, UK model) (Sony HFX) . . . . . (US, Canadian, E model)
  - 20–17,000 Hz
  - 30–15,000 Hz ( $\pm 3$  dB)
  - 30–15,000 Hz (DIN) (AEP, UK model)

**Wow and Flutter:** 0.04 % WRMS (NAB) } (AEP, UK model)  
 $\pm 0.14$  % (DIN)  
 0.04% WRMS (US, Canadian, E model)

**S/N Ratio:** DOLBY NR OFF

- AEP, UK, E model
  - With TYPE III cassette (Sony Fe-Cr)
    - 59 dB (NAB)
    - 56 dB (DIN, 1975 rev.)
  - With TYPE II cassette (Sony CD- $\alpha$ )
    - 57 dB (NAB)
- US, Canadian model
  - With TYPE III cassette (Sony Fe-Cr)
    - 59 dB at peak level
  - With TYPE II cassette (Sony EHF)
    - 57 dB at peak level

DOLBY NR ON  
 Improved by 5 dB at 1 kHz,  
 10 dB above 5 kHz

**Total Harmonic Distortion:** 1.0% (with Sony Fe-Cr cassette)

**Record Bias Frequency:** 105 kHz

**Inputs:** MIC (two phone jacks)  
 sensitivity 0.25 mV ( $-70$  dB) for a low-impedance microphone  
 LINE IN (two phono jacks)  
 sensitivity 77.5 mV ( $-20$  dB)  
 input impedance 50 k $\Omega$  or greater  
 REC/PB (connector) . . . (AEP, UK, E model)  
 input impedance less than 10 k $\Omega$

**Outputs:** LINE OUT (two phono jacks)  
 output level 0.44 V ( $-5$  dB) at load impedance 50 k $\Omega$   
 suitable load impedance more than 10 k $\Omega$   
 HEADPHONE (binaural jack)  
 output level 31 mV ( $-28$  dB) at load impedance 8  $\Omega$   
 REC/PB (connector) . . . (AEP, UK, E model)  
 output impedance less than 10 k $\Omega$

**Liquid Crystal Peak Program Meters:** Response range:  $-40$  dB to  $+8$  dB  
 Frequency response: 20 – 20,000 Hz  $\pm 1.5$  dB  
 Response time: 1 millisecond  
 Decay time (from 0 dB to  $-20$  dB): 750 milliseconds  
 Overshoot: None  
 Indicator elements: 33 elements for each channel

0 dB = 0.775 V

## MODEL IDENTIFICATION

– Specification Label –

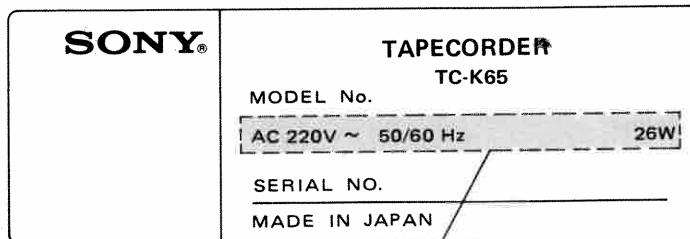

AC 220V ~ 50/60 Hz 26W . . . . . AEP model  
 AC 120V 60 Hz 24W . . . . . US, Canadian model  
 AC 240V ~ 50/60 Hz 26W . . . . . UK model  
 AC 110, 120, 220, 240V ~ 50/60 Hz 24W . . . . . E model

– Power Cord –

E1 model: euro-plug 1-551-530-00

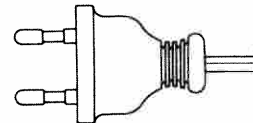

E2 model: parallel-blade plug 1-551-473-31

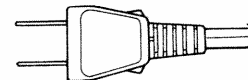

## SERVICING NOTE

When the top cover is removed the internal photo transistor may pick up stray light and shut the set off.

**Handling Precautions for MOS ICs (IC801 and IC802)**

Generally, the insulation resistance of the oxide layer in MOS IC structures is very high, and the oxide layer is very thin. Because of this, it is possible that the static voltages usually present on clothes and the human body will be enough to generate a potential difference across the insulator, high enough to cause a breakdown of the insulating layer.

The following precautions should be taken while handling these ICs.

(Particular care should be taken under conditions of low humidity.)

**Precautions in Replacing MOS ICs**

1. Store new ICs by inserting them into a urethane-polyester cushion (which is somewhat conductive), or wrapping it in aluminum foil, so that all the pins are at the same potential. (The ICs should be stored in that manner until mounted on the circuit board.)

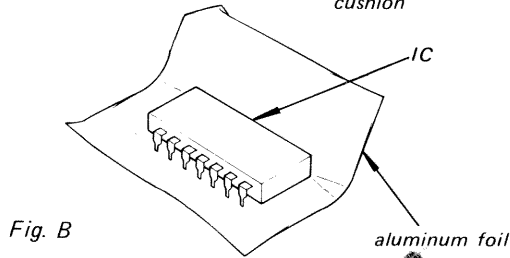
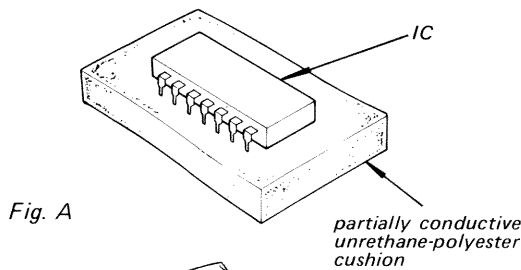

2. Check the soldering iron for possible power-line leakage current. Make sure that there is no leakage path by connecting an ohmmeter to the tip of the soldering iron and the plug as shown in Fig. C. If there is a leakage path, use some other soldering iron.

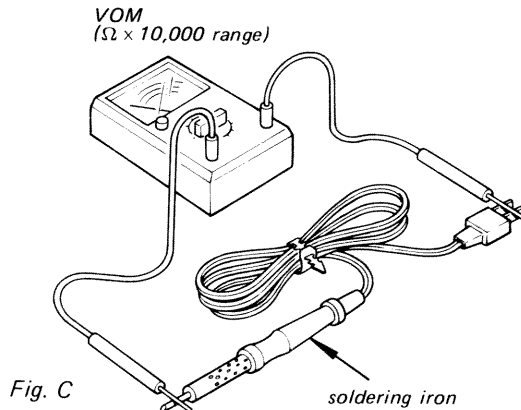

3. Equalize any potential difference between the clothes, the tools in use, the work bench, the set being worked on, and the packaged IC by touching them all in succession with the hands or a conductive wire or tool.
4. The following are effective methods for handling ICs that remove the potential difference across the oxide layer.
  - Use a paper clip modified by soldering in a wire braid insert.

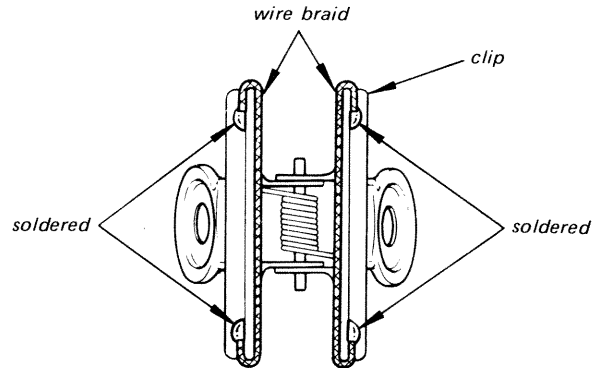

Make sure that there is no solder on the inside.

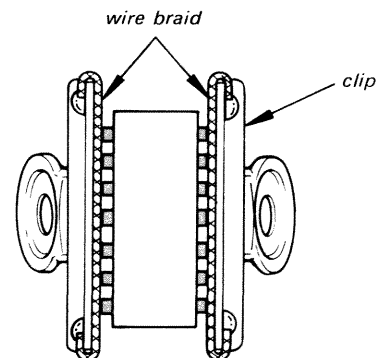
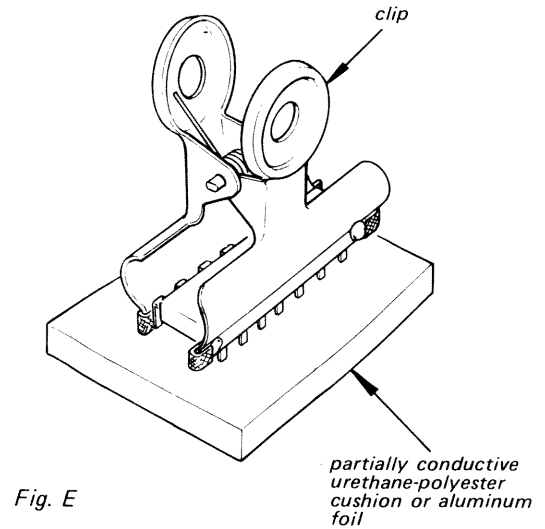

Make sure that all the pins are in contact with the wire braid (all the pins will then be at the same potential.).

- Take a short length of fine bare wire and wind it around the IC so that it shorts all the pins of the IC, while it is still in the urethane-polyester cushion or aluminum foil. This ensures that all the pins are at the same potential.

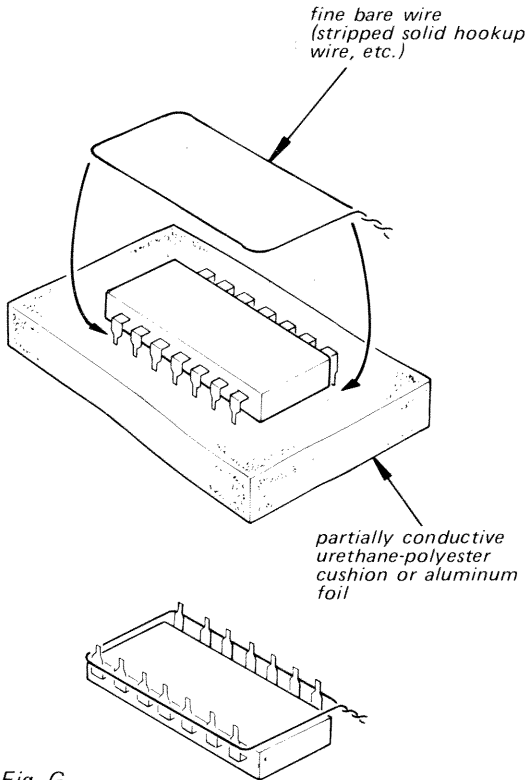

- When it is necessary to handle the IC with the fingers, do not touch any pin, and hold the IC at the ends of its plastic-package case as shown in Fig. H.

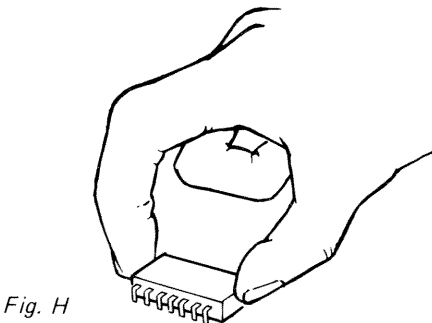

## 5. Method of Mounting

Insert the IC while holding it with the modified clip, and solder all the pins with the clip still shorting the pins. (Similarly, solder all the pins while the bare shorting wire is still wound around them.). Remove the clip or the bare shorting wire only after all the pins have been soldered.

## Precaution while Checking C-MOS ICs

The C-MOS ICs (Complementary MOS) are MOS ICs that have their output sections made up of N-channel and P-channel push-pull stages to increase their speed of operation. If the output terminal of these ICs comes into contact with B+ or B- voltage, then the FET which is ON at that time will either become shorted or open.

This is valid for all the output sections that are connected together by the interconnections. Even the circuits that are physically separated (and not on the same board) can be destroyed simultaneously.

### Example:

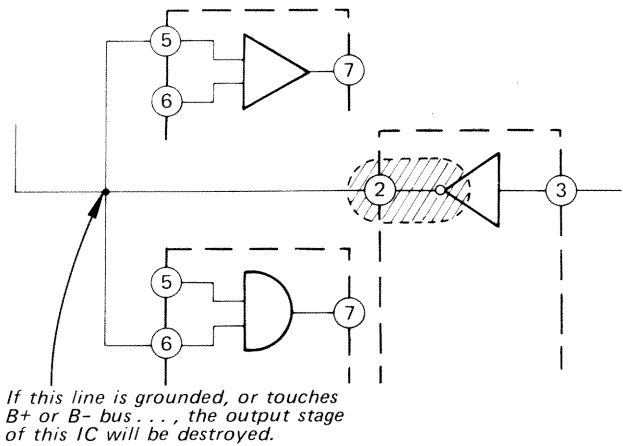

SECTION 1  
OUTLINE

1-1. BLOCK DIAGRAM  
- Audio Amp Section -

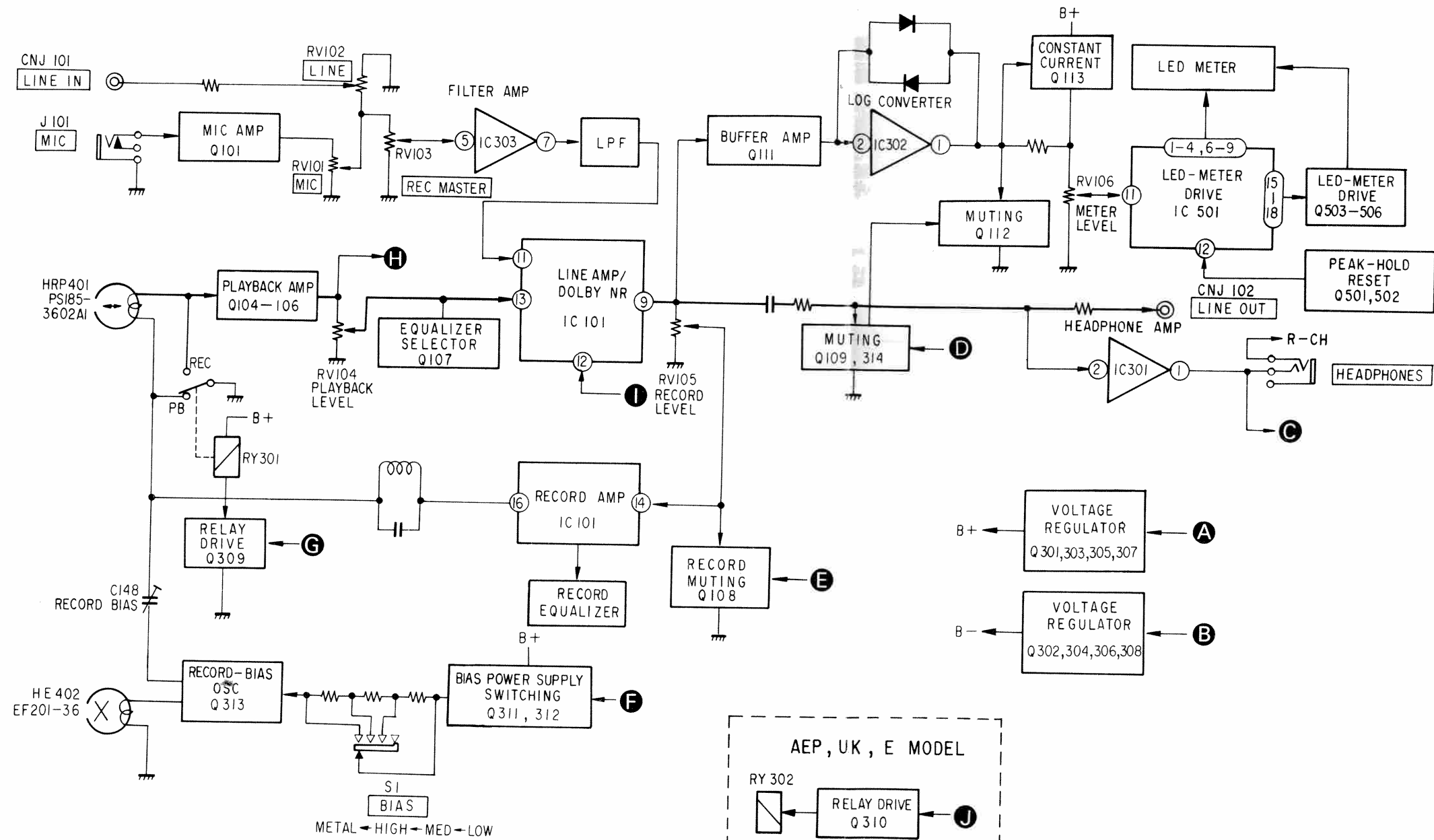

NOTE : R-CH IS THE SAME AS L-CH  
**A** — **J** : TO OR FROM SYSTEM CONTROL SECTION

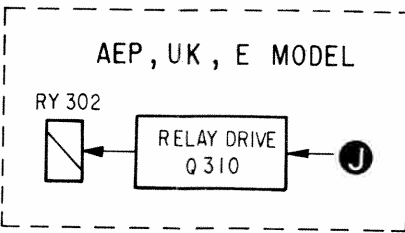

- System Control Section -

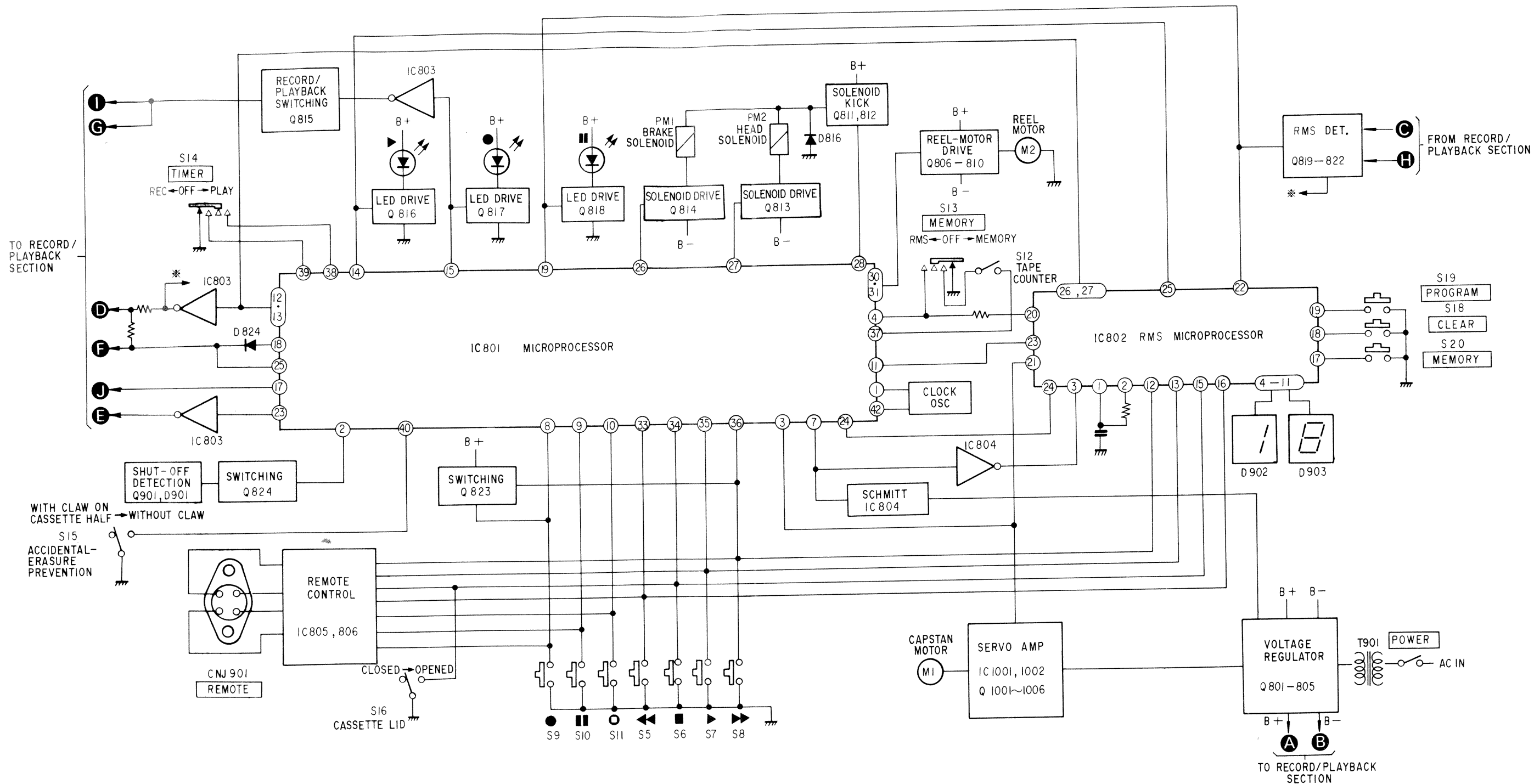

1-2. PROGRAM MEMORY OPERATION

A description of the step-by-step operation of the RMS circuit under an actual music program is given when five musics are recorded in a tape and, the first, third and the fifth musics are played back for an example.

	Operation	RMS Display	Mode
1	POWER switch: ON		stop
2	RMS/MEMORY COUNTER switch: RMS		↓
3	MEMORY switch: ON The first music in a tape is memorized in the first location of the memory IC.	 on and off	
4	PROGRAM switch: pushed twice		
5	MEMORY switch: ON The third music in a tape is memorized in the second location of the memory IC.	 on and off	
6	The fifth music in a tape is memorized in the third location of the memory IC in the same way as steps 4 and 5.		
7	Forward button: pushed on. Terminals 13 and 16 of IC802 become in low level.		
8	The tape comes in its beginning position.		stop
9	Terminals 12, 13 and 23 of IC802 become in low level.	 on and off	Playback and fast forward
10	Start of the first music: Terminal 22 of IC802 becomes in high level.		Stop. (rewinds a little bit)
11	Terminal 25 of IC802 becomes in high level and terminals 24, 26 and 27 of IC802 become in low level.		Playback
12	End of the first music: Terminal 22 of IC802 becomes in low level.		Stop

	Operation	RMS Display	Mode
13	Terminals 12 and 13 of IC802 become in low level.	 on and off	Playback and fast forward
14	Start of the third music: Terminal 22 of IC802 becomes in high level.		Stop (rewinds a little bit)
15	Terminal 25 of IC802 becomes in high level and terminals 24, 26 and 27 become in low level.		Playback
16	End of the third music		Stop
	↓	↓	↓
17	End of the fifth music. End of the program operation. Terminal 15 of IC802 becomes in low level.		Shut off

**TIME CHART OF IC802**

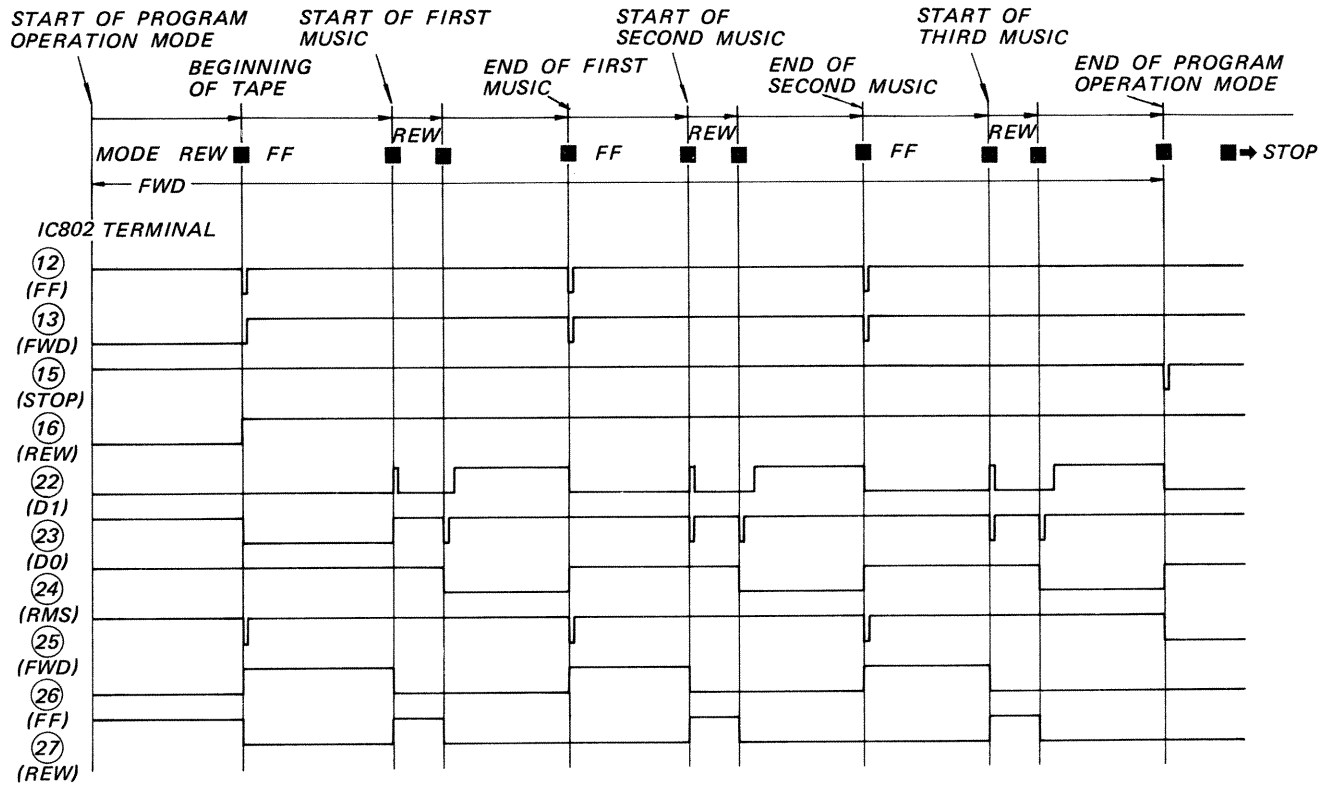



SECTION 2  
DISASSEMBLY

MEMO

- Follow the disassembly procedure in the numerical order given.

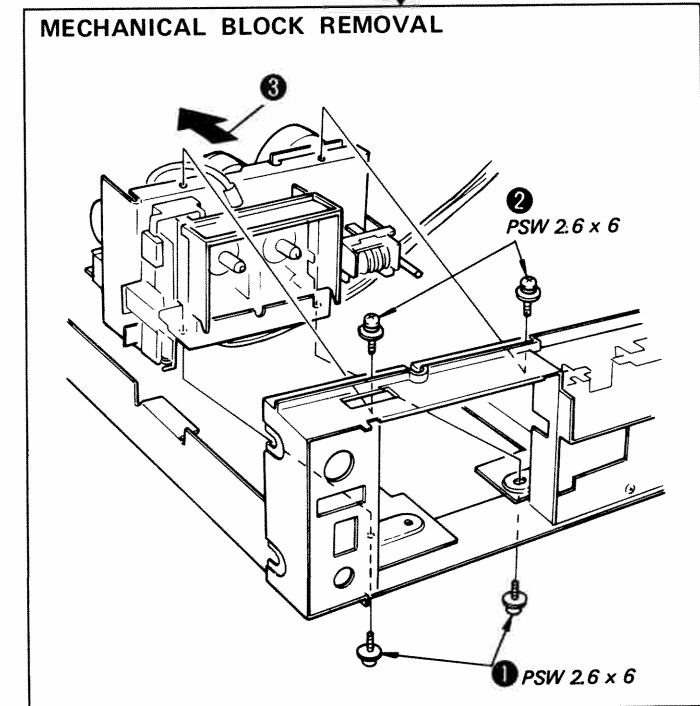
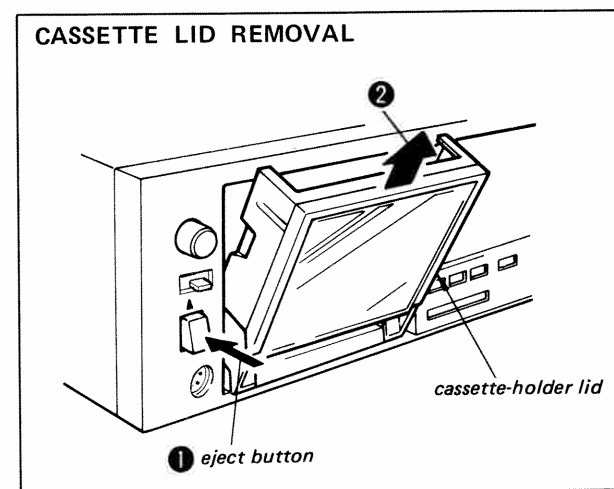
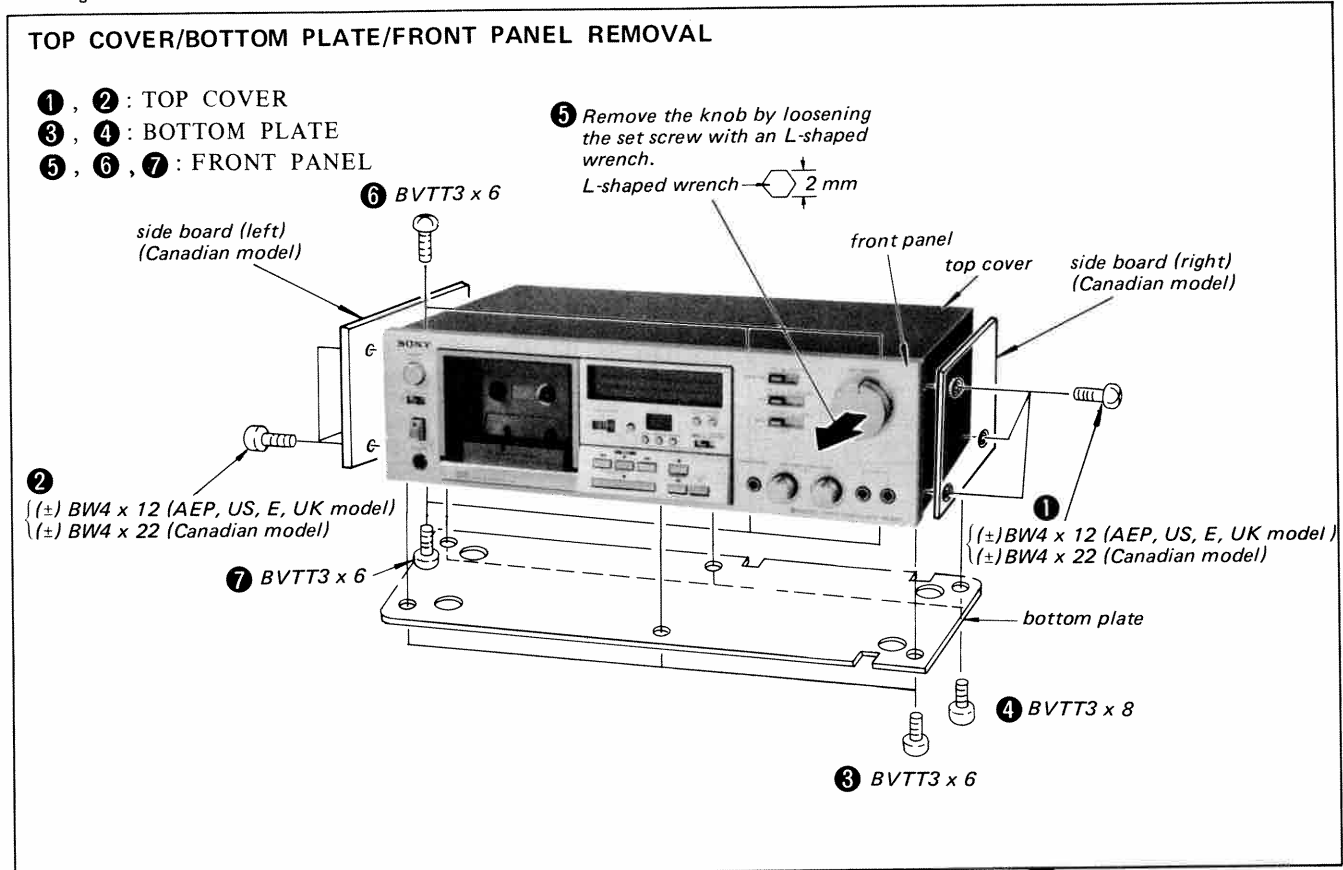

## SECTION 3 ADJUSTMENTS

### 3-1. MECHANICAL ADJUSTMENTS

#### PRECAUTION

1. Clean the following parts with a denatured-alcohol-moistened swab:
 

record/playback head	pinch roller
erase head	rubber belts
capstan	idlers
2. Demagnetize the record/playback head with a head demagnetizer.
3. Do not use a magnetized screwdriver for the adjustments.
4. After the adjustments, apply suitable locking compound to the parts adjusted.
5. The adjustments should be performed with the rated power supply voltage unless otherwise noted.

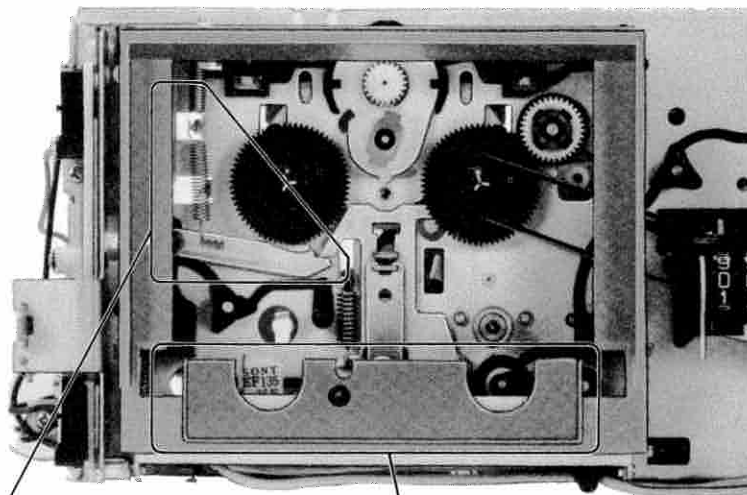

#### Torque Measurement and Back Tension Torque Adjustment

1. 

Torque	Torque meter	Meter reading
Forward	CQ-102	28–43 g · cm (0.39–0.59 oz · inch)
Back tension	CQ-102	2.5–4.5 g · cm (0.04–0.06 oz · inch)

2. If the specified back-tension torque is not obtained, change the hooking position.

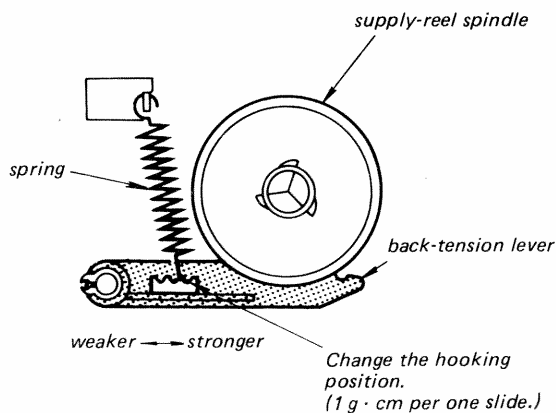

#### Head Height Adjustment

1. Prepare an adjustment cassette as shown below.

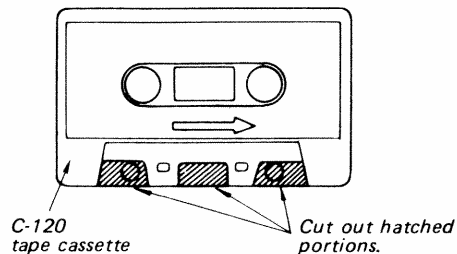

2. In playback mode and viewing from the front, adjust the head heights to eliminate tape curl and tape twist at portions of arrows.

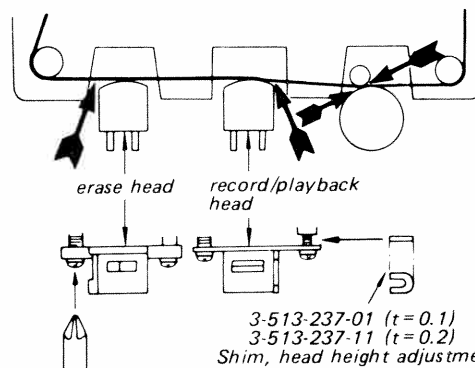

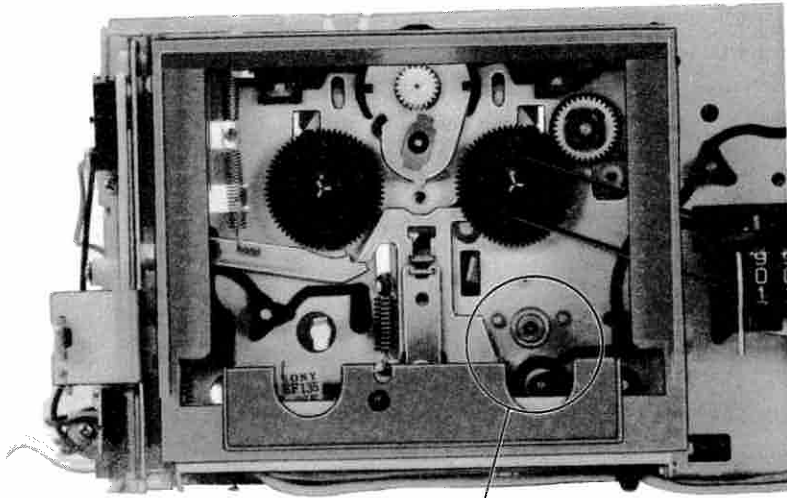

**Pinch Roller Pressure Measurement**  
— Forward Mode —

280-380 g  
(10-13 oz)

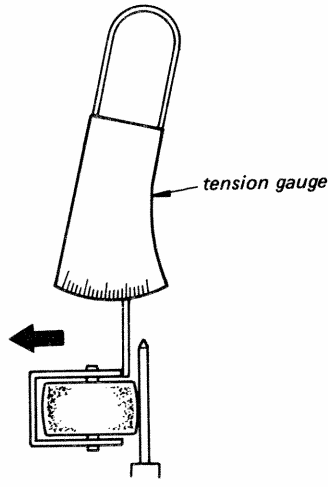

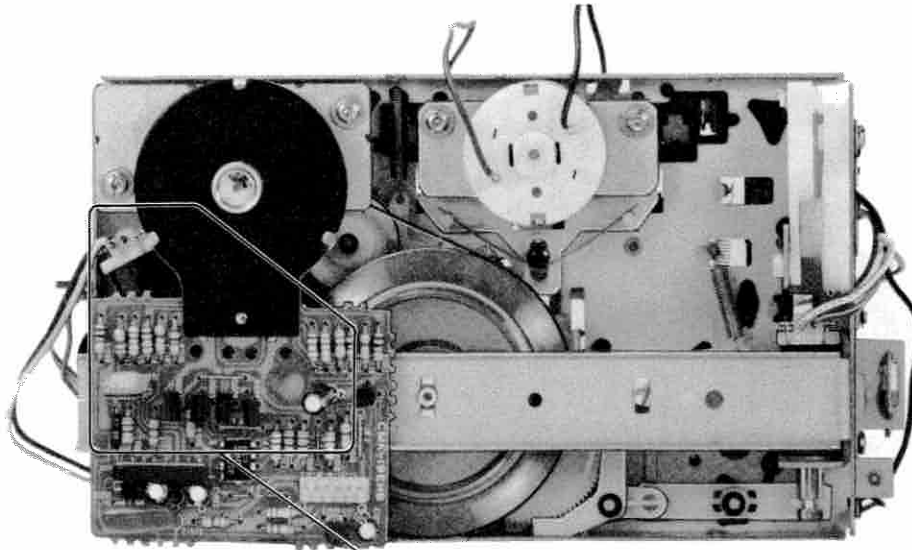

**Brake Solenoid (PM1) Position Adjustment**

– Stop Mode –

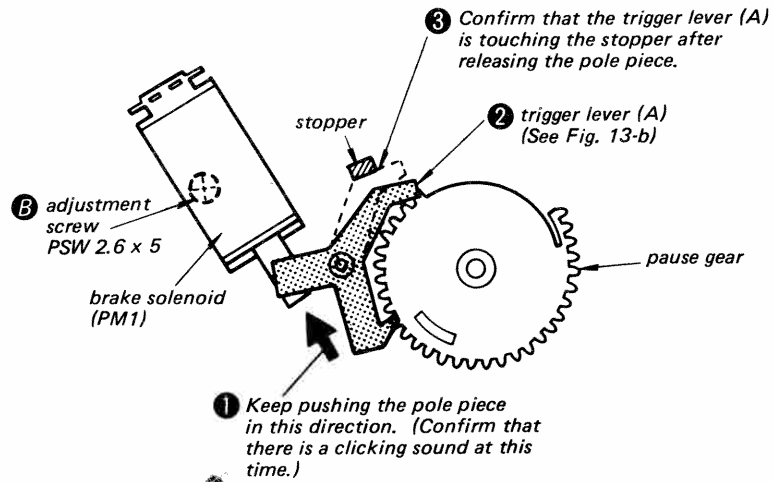

Fig. 13-a

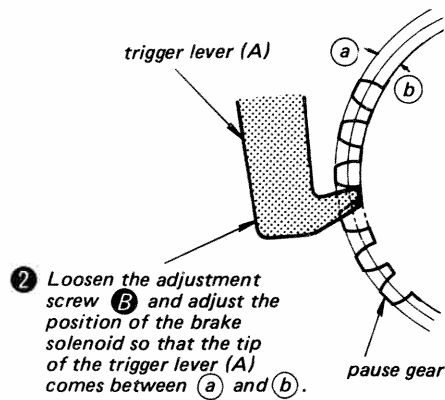
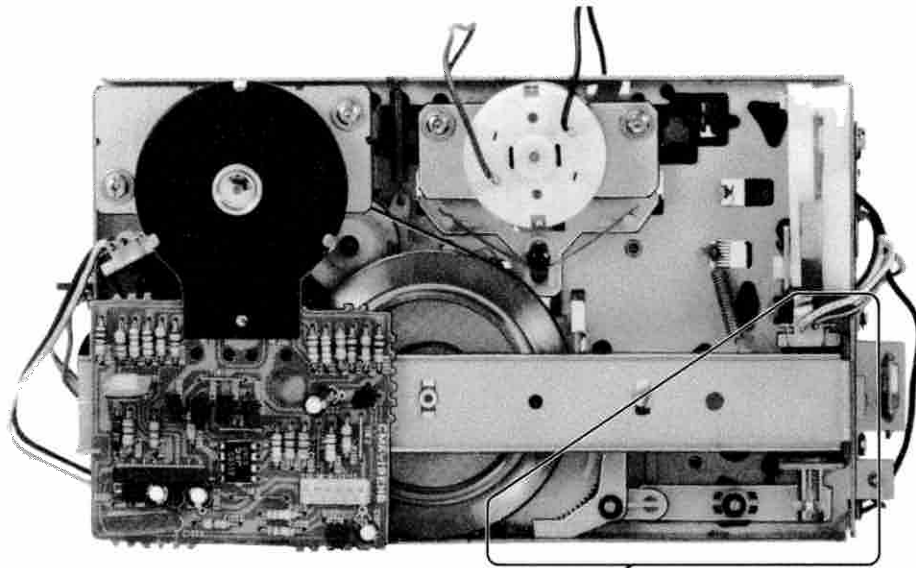

Fig. 13-b



**Head Solenoid (PM2) Position Adjustment**  
 — Stop Mode —

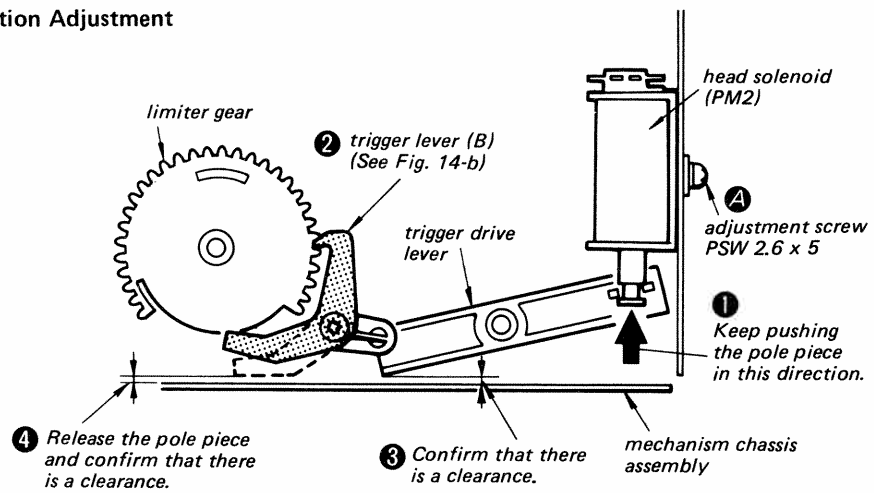

Fig. 14-a

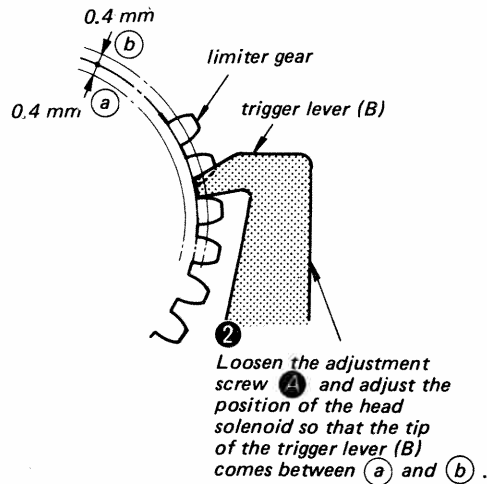

Fig. 14-b

### 3-2. ELECTRICAL ADJUSTMENTS

**Note:** The adjustment should be performed in the order given in this service manual. The adjustments should be performed for both L-CH and R-CH.

- Set the BIAS and EQ switches according to the tape as follows.

Tape	BIAS switch	EQ switch
CS-10	MED	TYPE I
CS-25	HIGH	TYPE II
CS-30	MED	TYPE III
CS-40	METAL	TYPE IV

- Switches and controls should be set as follows unless otherwise specified.

DOLBY NR switch: OFF  
 EQ switch: TYPE I  
 BIAS switch: MED  
 REC MUTE switch: OFF

- Standard Record:

Deliver the standard input signal level to the input jack and set the REC LEVEL control to obtain the standard output signal level.

#### Standard Input Level

	MIC	LINE IN	REC/PB (AEP, UK, E model)
source impedance	300 Ω	10 kΩ	100 kΩ
input level	0.77 mV (-60 dB)	0.25 V (-10 dB)	1 mV (-33 dB)

#### Standard Output Level

	LINE OUT	HEAD-PHONES	REC/PB (AEP, UK, E model)
load impedance	47 kΩ	8Ω	50 kΩ
output level	0.44 V (-5 dB)	31 mV (-28 dB)	0.44 V (-5 dB)

### Tape Speed Adjustment

#### Procedure:

Mode: playback

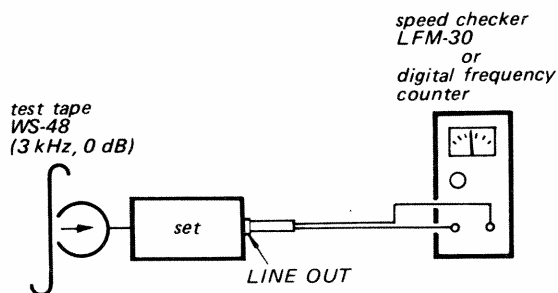

#### Specification:

Speed checker	Digital frequency counter
-0.7 - +0.7 %	2,980 - 3,020 Hz

Frequency difference between the beginning and the end of the tape should be within 0.7 % (20 Hz).

#### Adjustment Location:

- servo amp board -

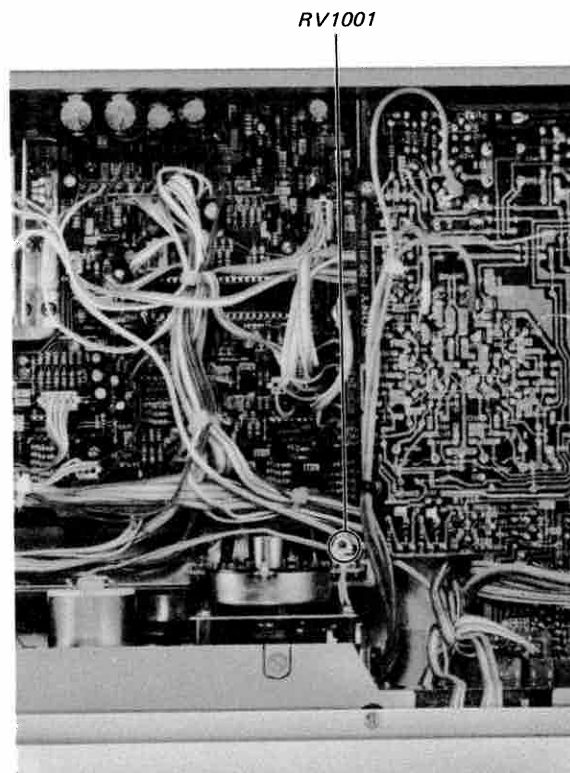

**Record/playback Head Azimuth Adjustment**

**Procedure:**

1. Mode: playback

test tape  
P-4-A81  
(6.3 kHz, -10 dB)

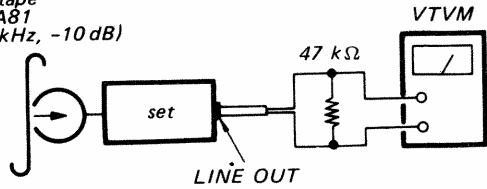

2. Turn the adjustment screw for the maximum output levels. If these levels do not match, turn the adjustment screw where both of output levels match together within 0.5 dB.

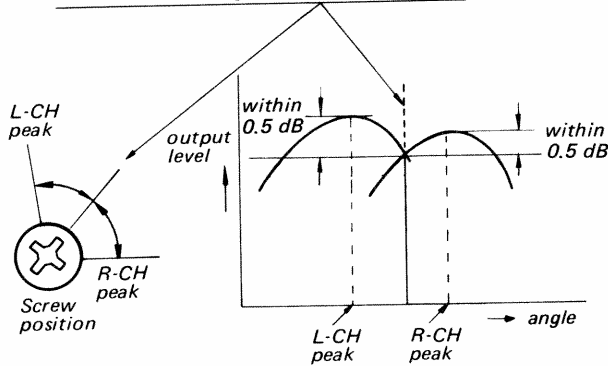

3. Phase Check

Mode: playback

test tape  
P-4-A81  
(6.3 kHz, -10 dB)

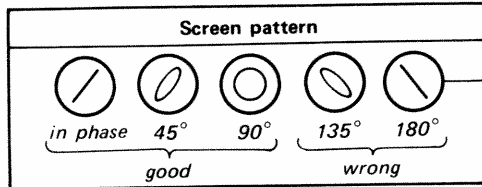
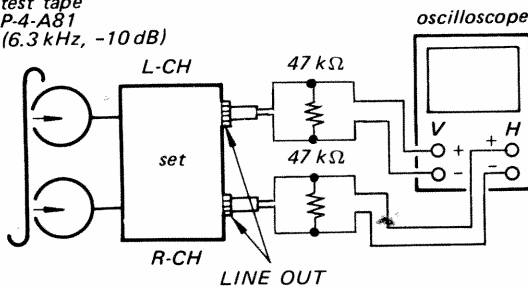

**Adjustment Location:**

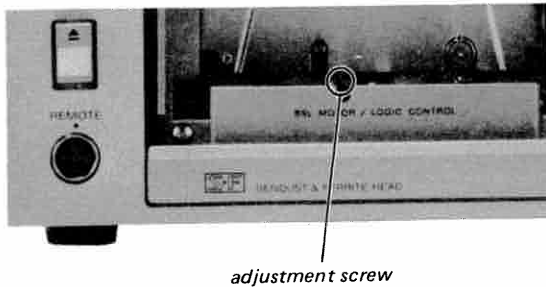

**Playback Level Adjustment**

**Procedure:**

Mode: Playback

test tape  
P-4-L81  
(333 Hz, 0 dB)

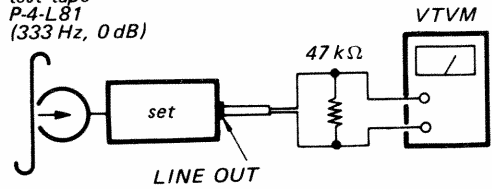

Adjust RV104 (L-CH) and RV204 (R-CH) to obtain the specified LINE OUT level.

**Specification:**

LINE OUT level: 0.52 – 0.59 V  
(–3.5 to –2.5 dB)

Level difference between channels:  
less than 0.5 dB

Check that the LINE OUT level does not change in playback mode while changing the mode from playback to stop several times.

**Adjustment Location:**

– record/playback board –

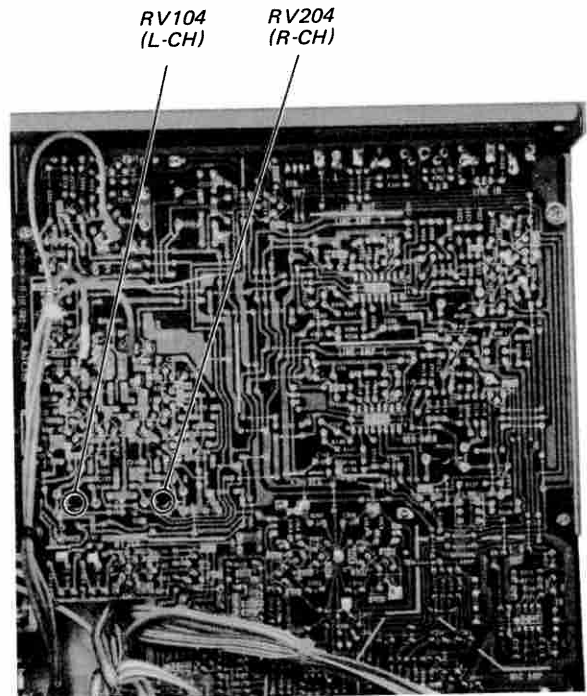

### Playback Equalizer Adjustment

**Procedure:**

Mode: playback

test tape  
P-4-A82  
(10 kHz, -10 dB)

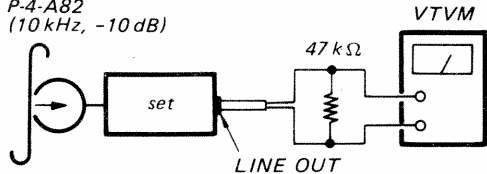

**Specification:**

BIAS switch	EQ switch	LINE OUT level
MED	TYPE I	0.12 – 0.27 V (-16 to -9 dB)
HIGH	TYPE II	0.077 – 0.17 V (-20 to -13 dB)

**Adjustment Location:**

– record/playback board –

Bridge patterns	10 kHz level
Ⓐ	up (approx. 0.5 dB)

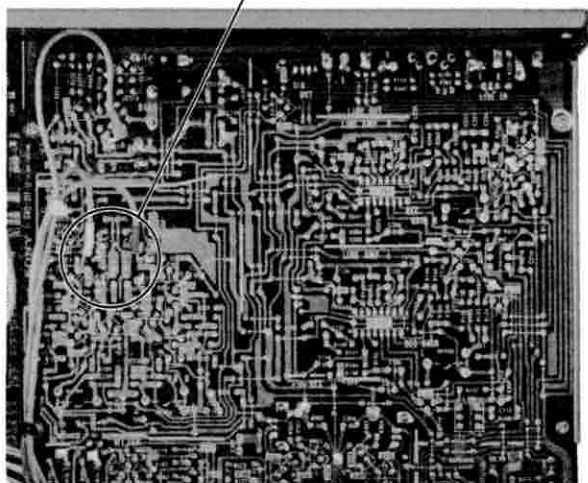
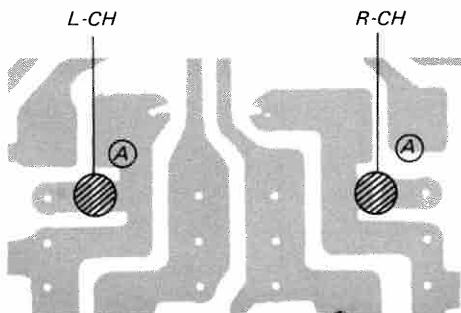

### Record Bias Adjustment

**Setting:**

REC LEVEL control: standard record  
(See page 17.)

**Procedure:**

1. Mode: record

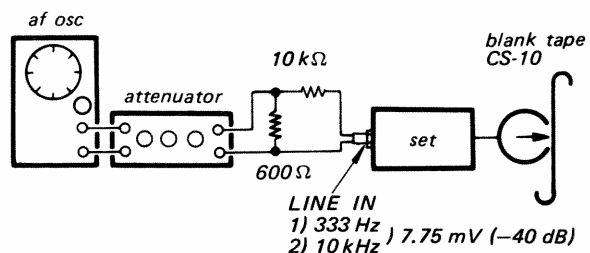

2. Mode: playback

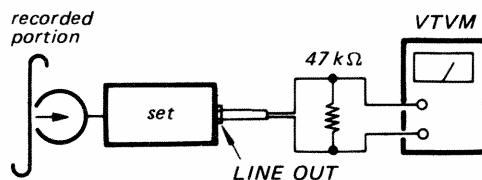

Confirm that the LINE OUT level of 10 kHz signal is 0 dB relative to that of 333 Hz.  
If necessary, adjust C148 (L-CH) and C248 (R-CH).

**Adjustment Location:**

– record/playback board –

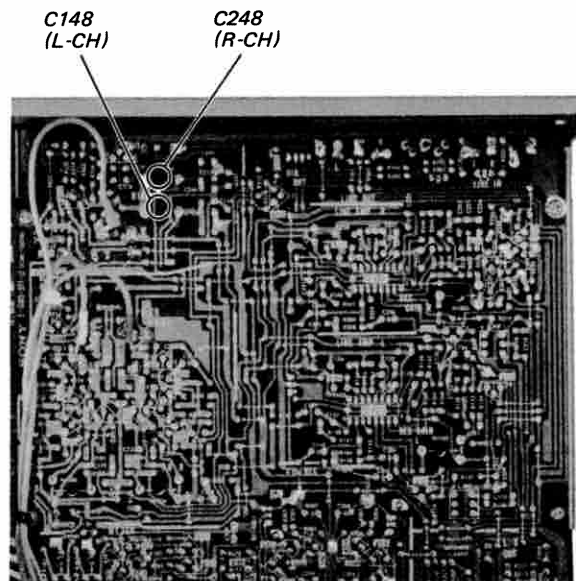



SECTION 4  
DIAGRAMS

Record Level Adjustment

Setting:

REC LEVEL control: standard record  
(See page 17.)

Procedure:

1. Mode: record

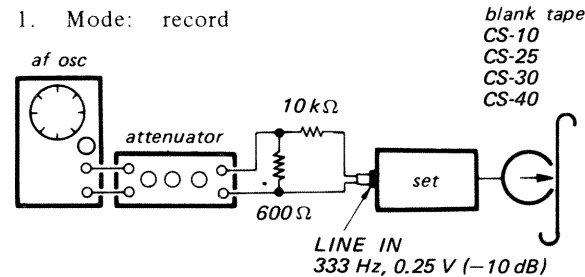

2. Mode: playback

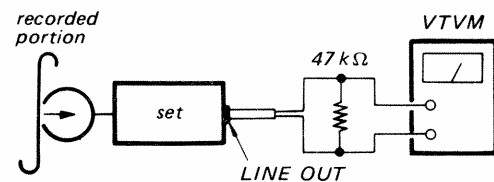

Adjust RV105 (L-CH) and RV205 (R-CH) to obtain the specified LINE OUT level.

Specification:

Tape	LINE OUT Level
CS-10	0.41 - 0.46 V (-5.5 to -4.5 dB)
CS-25, 30, 40	0.37 - 0.52 V (-6.5 to -3.5 dB)

Adjustment Location:

- record/playback board -

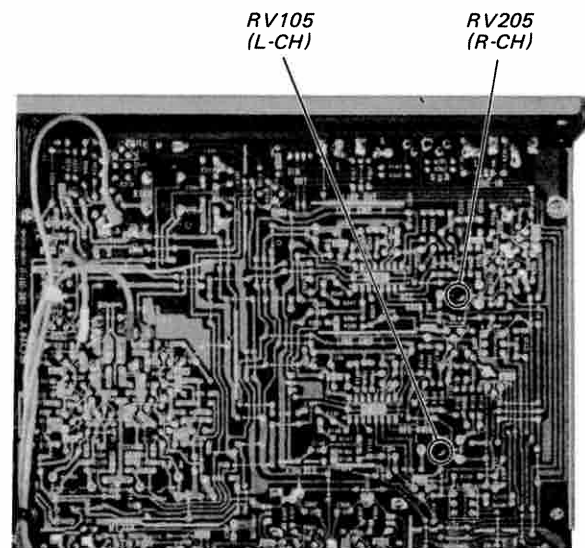

Level Meter Calibration

Setting:

REC LEVEL control: standard record  
(See page 17.)

Procedure:

1. Mode: record

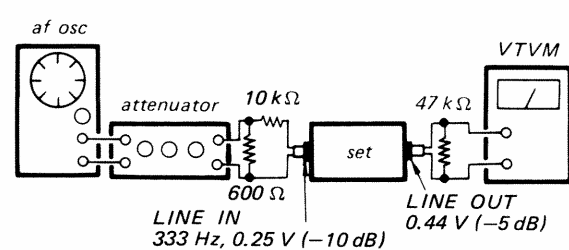

2. Just after the element at -2 dB (□□ mark) turned off, adjust RV106 (L-CH) and RV206 (R-CH) so that the element at 0 VU (-4 dB) keeps turning on.

3. Increase the LINE IN level to +2 dB ± 1 dB. The right-most element at +8 dB should turn on.

4. Decrease the LINE IN level to -46 dB ± 3 dB. The second element from the left end should turn off. If not even with a LINE IN level of -49 dB, bridge the patterns as follows.

Adjustment Location:

- record/playback board -

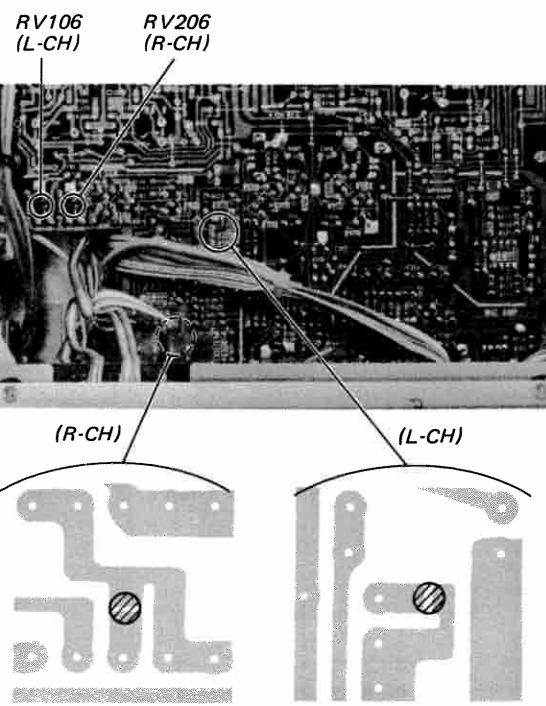

Voltages and Waveforms at the Terminals of IC801.

Terminal No.	Waveform or Voltage	Terminal No.	Waveform or Voltage	Terminal No.	Waveform or Voltage
①		⑭		⑲	10 Vdc
②	<ul style="list-style-type: none"> <li>• Forward Mode: </li> <li>• Fast Forward Mode: </li> </ul>	⑮		⑳	 0.3 sec. Fast Forward button is pushed.
		⑯	10 Vdc		
③	 8 msec	⑰	 0.5 sec Forward button is pushed.	㉑	 0.3 sec Rewind button is pushed.
		⑱		㉒	10 Vdc
④	MEMORY SWITCH RMS: 0 V OFF: 10 V	⑲		㉓	
⑤, ⑥	10 Vdc			㉔	
⑦	 4 sec S901 (POWER): ON  0.5 sec S901 (POWER): ON	⑳ to ㉒	10 Vdc	㉕	
		⑳		㉖	
⑧		㉑		㉗	
⑨		㉒		㉘ to ㉚	10 Vdc
⑩		㉓		㉛	When the accidental erasure prevention tab is broken: 0 V When the accidental erasure prevention tab is not broken: 10 V
⑪	MEMORY SWITCH : RMS START OF MUSIC	㉔		㉜	0 Vdc
⑫, ⑬		㉕		㉝	

Recon  
Proce  
1.  
tes  
P.-  
(6)  
2.  
L-CF  
peak  
Scr  
pos  
3.

### 4-1. SCHEMATIC DIAGRAM — System Control Section —

Refer to page 21 for voltages and waveforms at the terminals of IC801, and to page 27 for those of IC802.

**Note:**

- All capacitors are in  $\mu\text{F}$  unless otherwise noted.  $\text{pF} = \mu\mu\text{F}$
- 50WV or less are not indicated except for electrolytics.
- All resistors are in ohms,  $\frac{1}{2}\text{W}$  unless otherwise noted.  $\text{k}\Omega : 1000\Omega, \text{M}\Omega = 1000\text{k}\Omega$
- : nonflammable resistor.
- 1% indicates component tolerance.
- : B+ bus.
- : B- bus.
- : panel designation.
- : adjustment for repair.
- Voltages are dc with respect to ground unless otherwise noted.
- Readings are taken with a VOM (20  $\text{k}\Omega/\text{V}$ ).
- no mark: STOP
- : FORWARD
- : FAST FORWARD
- : REWIND
- : RECORD
- : REC MUTE
- : PAUSE
- : STOP
- Voltage variations may be noted due to normal production tolerances.
- Switch

Ref. No.	Switch	Position
S5	REWIND	OFF
S6	STOP	OFF
S7	FORWARD	OFF
S8	FAST FORWARD	OFF
S9	RECORD	OFF
S10	PAUSE	OFF
S11	REC MUTE	OFF
S12	TAPE COUNTER	OFF
S13	MEMORY COUNTER	OFF
S14	TIMER	OFF
S15	ACCIDENTAL-ERASURE PREVENTION	ON
S16	CASSETTE LID	OFF
S18	CLEAR	OFF
S19	PROGRAM	OFF
S20	MEMORY	OFF
S901	POWER	OFF

Note: The components identified by shading and mark are critical for safety. Replace only with part number specified.

Note: Les composants identifiés par un tramé et une marque sont critiques pour la sécurité. Ne les remplacer que par une pièce portant le numéro spécifié.

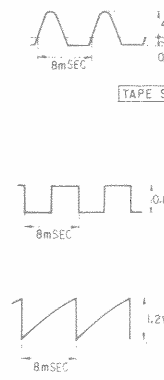
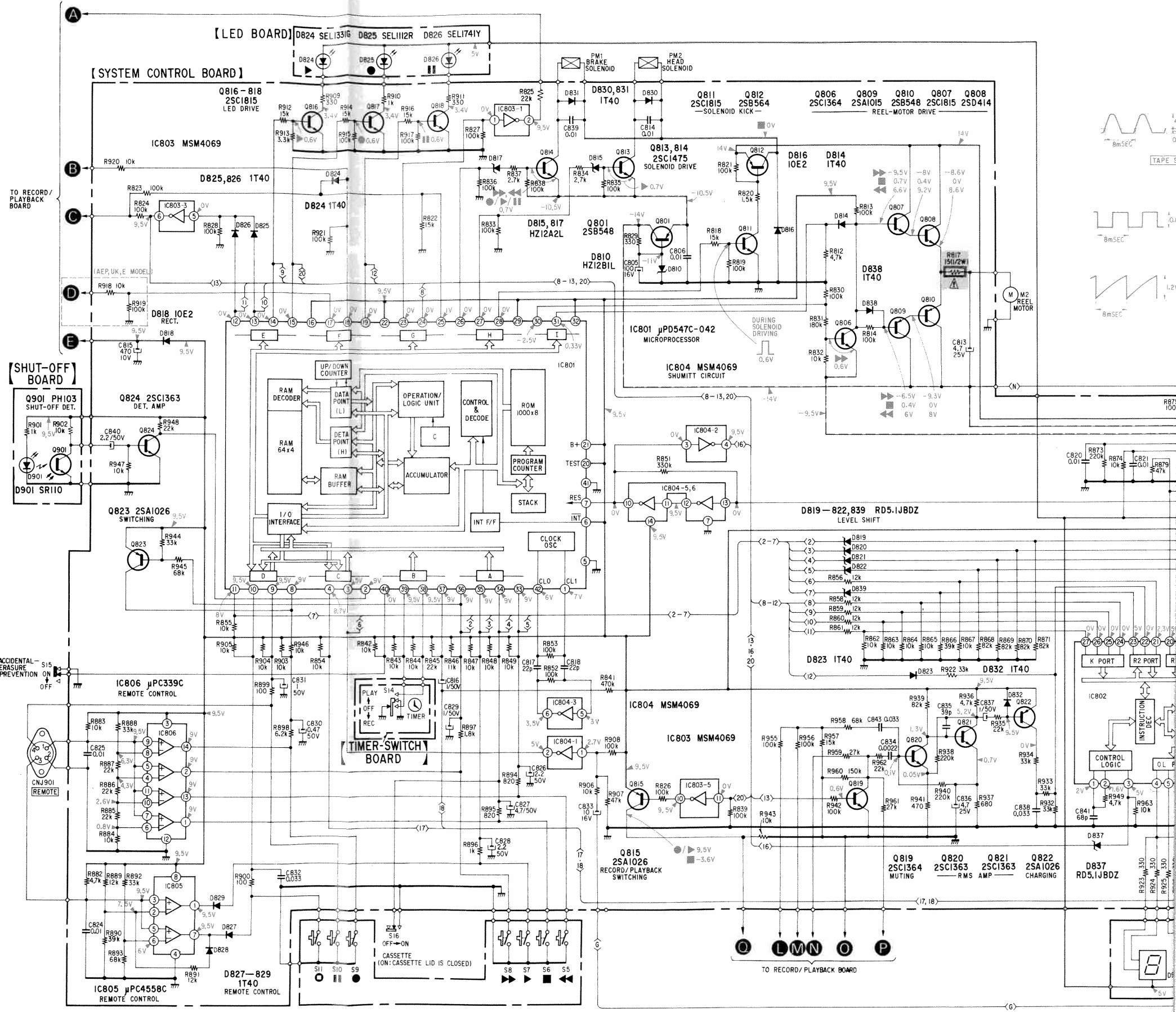

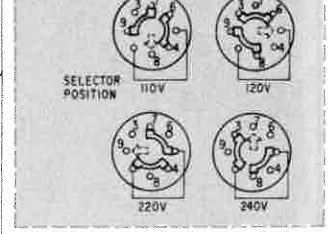
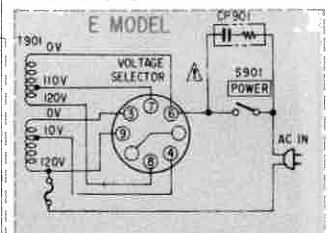
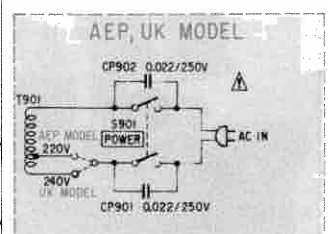
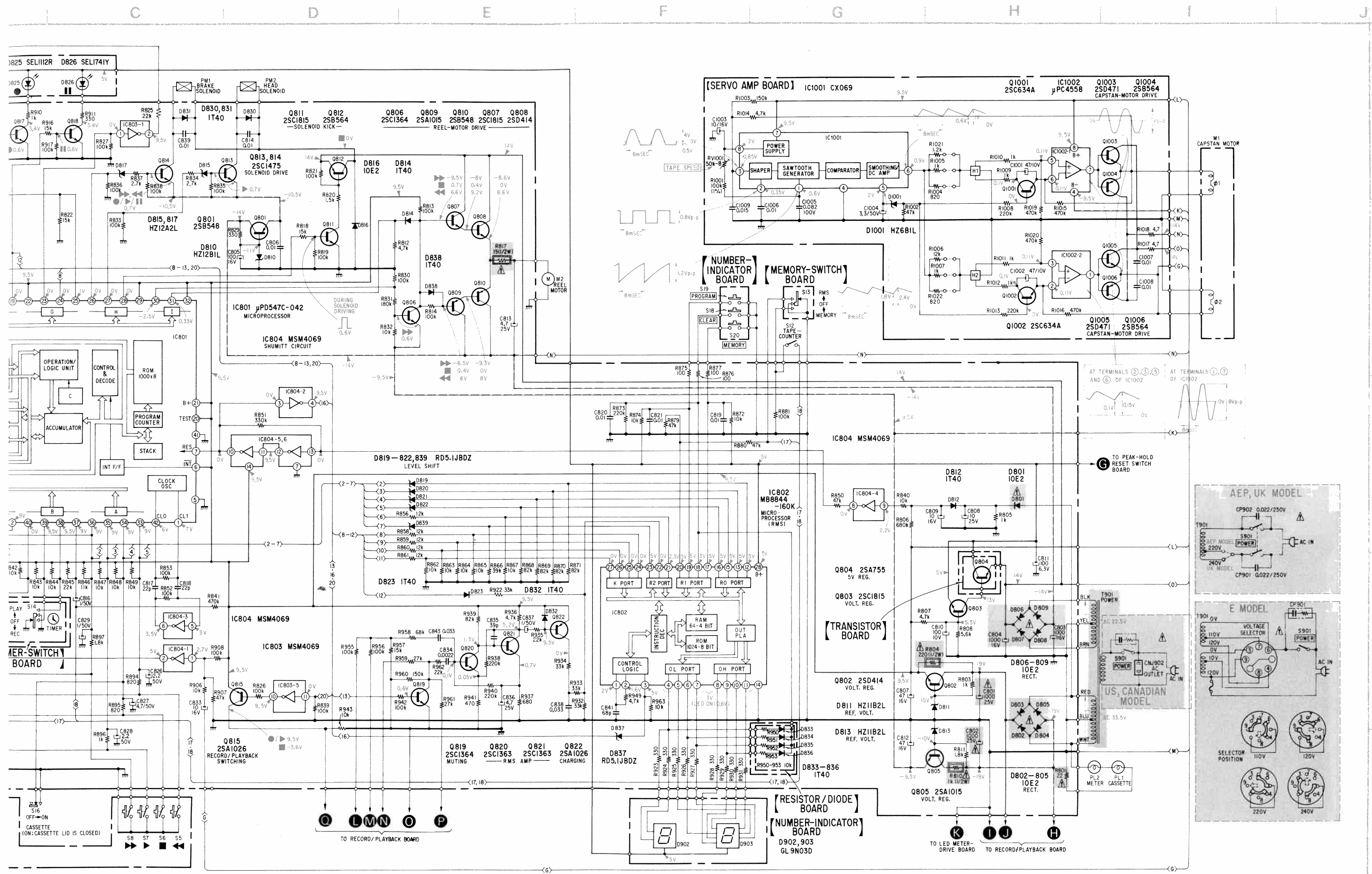

4-2. MOUNTING DIAGRAM — System Control Section —

— Conductor Side —

Refer to page 21 for voltages and waveforms at the terminals of IC801, and to page 27 for those of IC802.

TC-K65 TC-K65

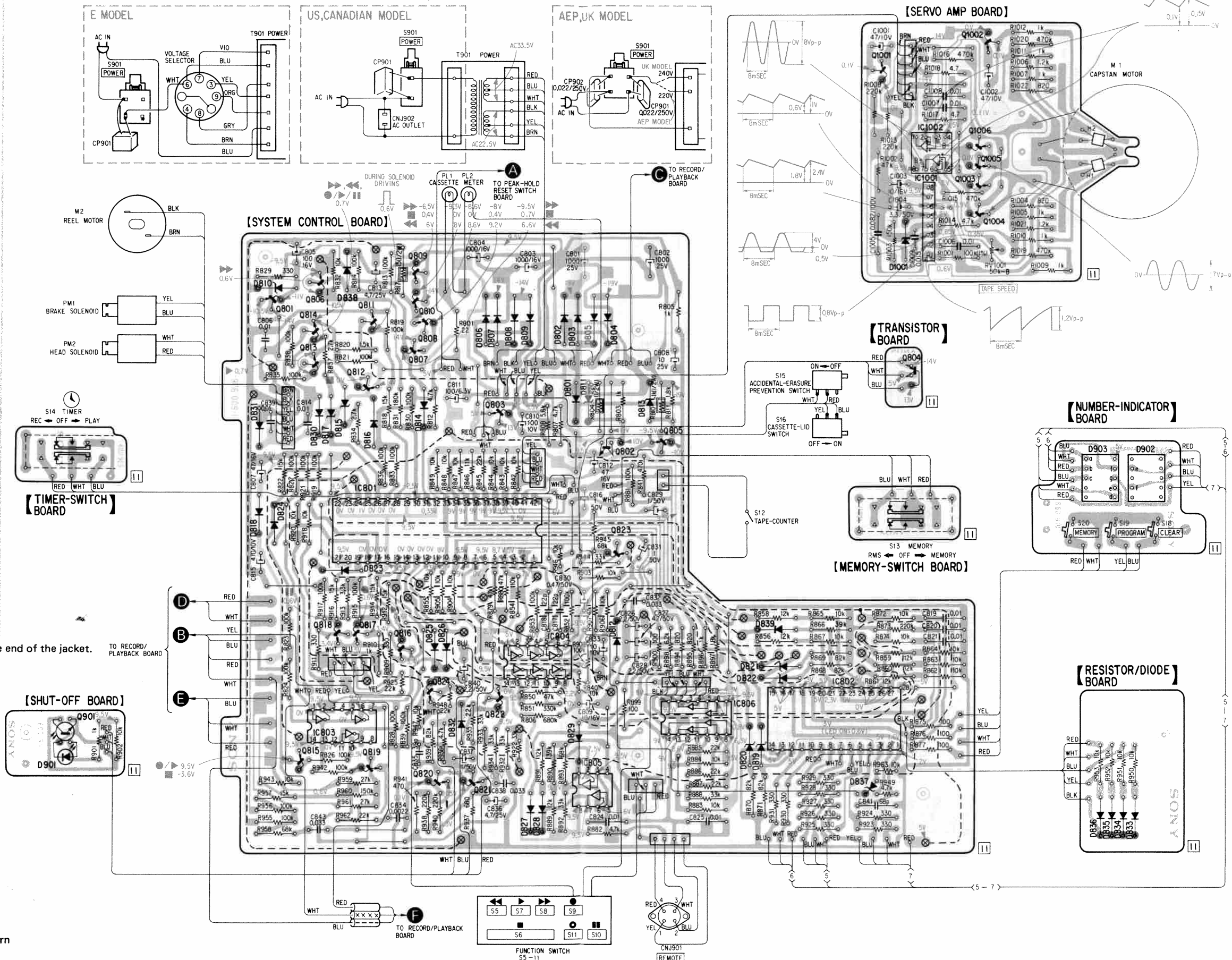

Note:

- Color code of sleeving over the end of the jacket.

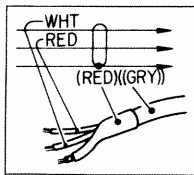

- ⊗ : B+ pattern.
- no mark: STOP
- ▶ : FORWARD
- ▶▶ : FAST FORWARD
- ◀◀ : REWIND
- ◀ : RECORD
- ⊙ : REC MUTE
- ⊞ : PAUSE
- : STOP
- ⊗ : through hole component-side pattern

Q, IC	D
1002	
1001	
1006	
IC1002	
1005	
1003	
1004	
IC1001	1001
809	838
806	810
801 810	
811 808	806-809
814 808	802-805
807	
813 804	
812	
803	801 811
	815 814 813
	830 817 815
	831 816
802 805	
	903 902
IC801	818 824
823	
	823
818 817	839
816	825,826 812
IC804	
	821
	822
824 822	
IC806, IC802	
IC803 901	832
	829
815 819	820, 819
820, 821	901
IC805	
	837
	827, 828
	833-836
Q, IC	D

Replacement Semiconductors

For replacement, use semiconductors except in ( ).

Q801, 810: 2SB548

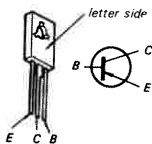

Q802, 808: 2SD414

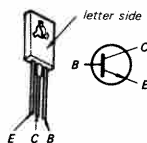

Q803, 807, 811): 2SC1364 (2SC1815)  
Q816, 817, 818

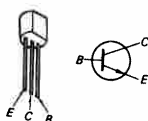

Q804: 2SA671 (2SA755)

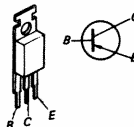

Q805, 809: 2SA1015  
Q815  
Q822 } : 2SA1027R  
Q823 } (2SA1026)

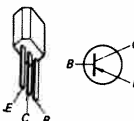

Q806, 819  
Q820, 821, 824): 2SC1364 (2SC1363)  
Q813, 814: 2SC2001 (2SC1475)  
Q1001, 1002: 2SC1364 (2SC634A)  
Q1003, 1005: 2SC1474 (2SD471)

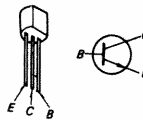

Q1004, 1006: 2SA684 (2SB564)

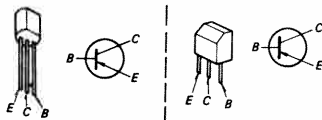

Q812: 2SB564

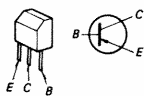

Q901: PH103-1M (PH103)

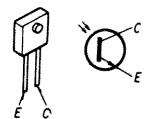

IC801:  $\mu$ PD547C042

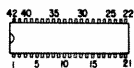

(Top view)

IC802: MB8844-160  
(MB8844-160K)

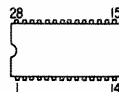

(Top view)

IC803, 804: MSM4069

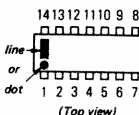

(Top view)

IC805, 1002:  $\mu$ PC4558C  
( $\mu$ PC4558)



(Top view)

IC806:  $\mu$ PC339C

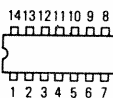

(Top view)

IC1001: CX069

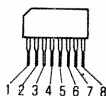

D801-809): 10E2  
D816, 818 ) 1S1555  
D812, 814, 823): 1S1555  
D827-836, 841): (1T40)  
D819-822), RD5.1E-C  
D837 ) (RD5.1JBDZ)

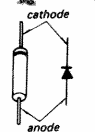

D811, 813: HZ11B2L  
D815, 817: HZ12A3L (HZ12A2L)  
D1001: HZ6B2L (HZ6B1L)

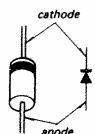

D901: SR110

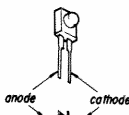

D902, 903: GL9N03D



(Rear view)

D824: SEL1331G  
D825: SEL1112R  
D826: SEL1741Y

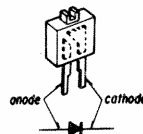

Voltages and Waveforms at the Terminals of IC802

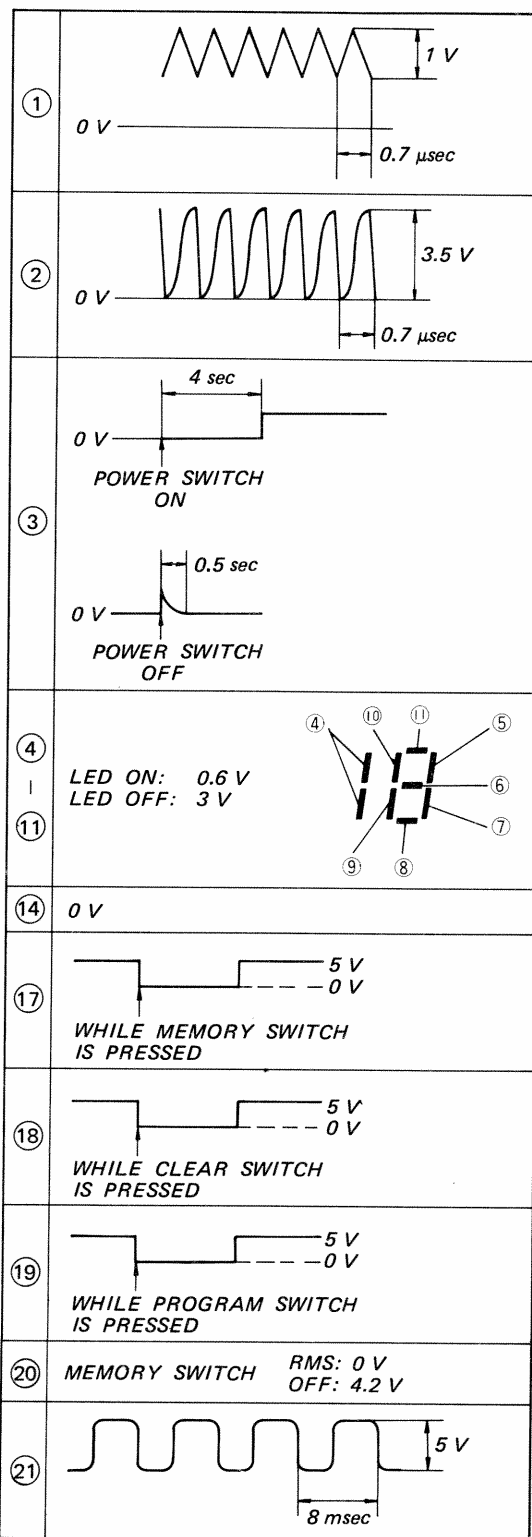

**Replacement Semiconductors**

For replacement, use semiconductors except in ( ).

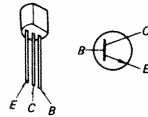
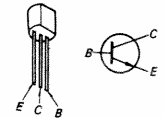
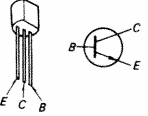
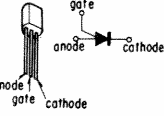
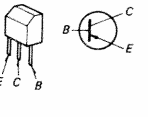
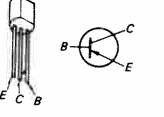
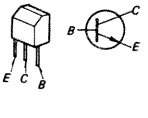
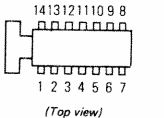
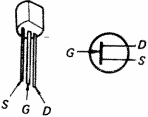
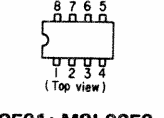
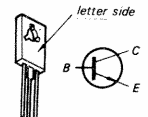
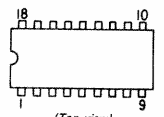
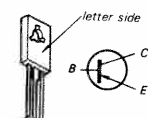
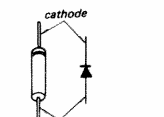
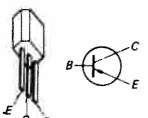
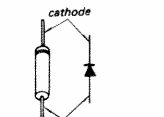
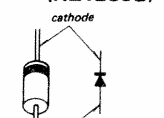
<p><b>Q101, 201:</b> 2SC1345 (2SC1345E)</p> <p><b>Q109, 209:</b> 2SC2001</p> <p><b>Q107, 207</b> <b>Q111, 211</b> <b>Q113, 213</b> <b>Q310, 502</b> } 2SC1364</p> 	<p><b>Q313:</b> 2SC1475 (2SC1213A)</p> 
<p><b>Q305:</b> 2SC1364 (2SC458A)</p> 	<p><b>Q501:</b> N13T1</p> 
<p><b>Q104, 204</b> <b>Q106, 206</b> <b>Q308</b> } 2SA1138 (2SA1138F)</p> 	<p><b>Q503~506:</b> 2SA952</p> 
<p><b>Q105, 205:</b> 2SC2676 (2SC2676F)</p> 	<p><b>IC101, 201:</b> CX174</p>  <p>(Top view)</p>
<p><b>Q301, 302:</b> 2SK30A</p> 	<p><b>IC301:</b> NJM4560D (<math>\mu</math>PC4557C)</p> <p><b>IC302:</b> <math>\mu</math>PC4558C</p> <p><b>IC303:</b> NJM4560D</p>  <p>(Top view)</p>
<p><b>Q303:</b> 2SD414</p> 	<p><b>IC501:</b> MSL9350 (MSL9350RS)</p>  <p>(Top view)</p>
<p><b>Q304:</b> 2SB548</p> 	<p><b>D101, 201</b> <b>D301, 302</b> <b>D306, 502</b> } 1S1555 (1T40)</p> 
<p><b>Q306:</b> 2SA1027R (2SA844)</p> <p><b>Q311, 314:</b> 2SA1027R (2SA1026)</p> 	<p><b>D102 ~ 105</b> <b>D202 ~ 205:</b> 1S1555</p> 
	<p><b>D303, 304:</b> HZ6B2L (HZ6B1L)</p> <p><b>D305:</b> HZ12C2L (HZ12C3L)</p> 

**4-3. MOUNTING DIAGRAM — Audio Amp Section —**  
— Conductor Side —

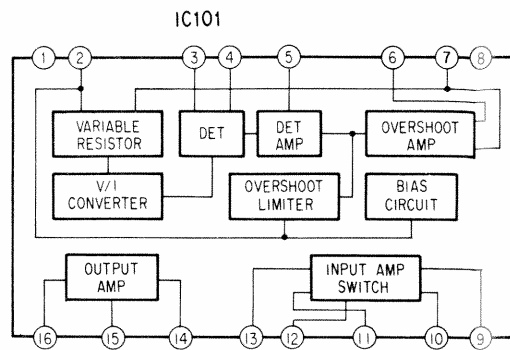

**Note:**

- Color code of sleeving over the end of the jacket.

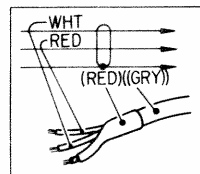

- : B+ pattern.
- : signal path
- : L-CH
- : R-CH
- no mark: STOP
- ▶ : FORWARD
- ▶▶ : FAST FORWARD
- ◀◀ : REWIND
- : RECORD
- : REC MUTE
- : PAUSE
- : STOP

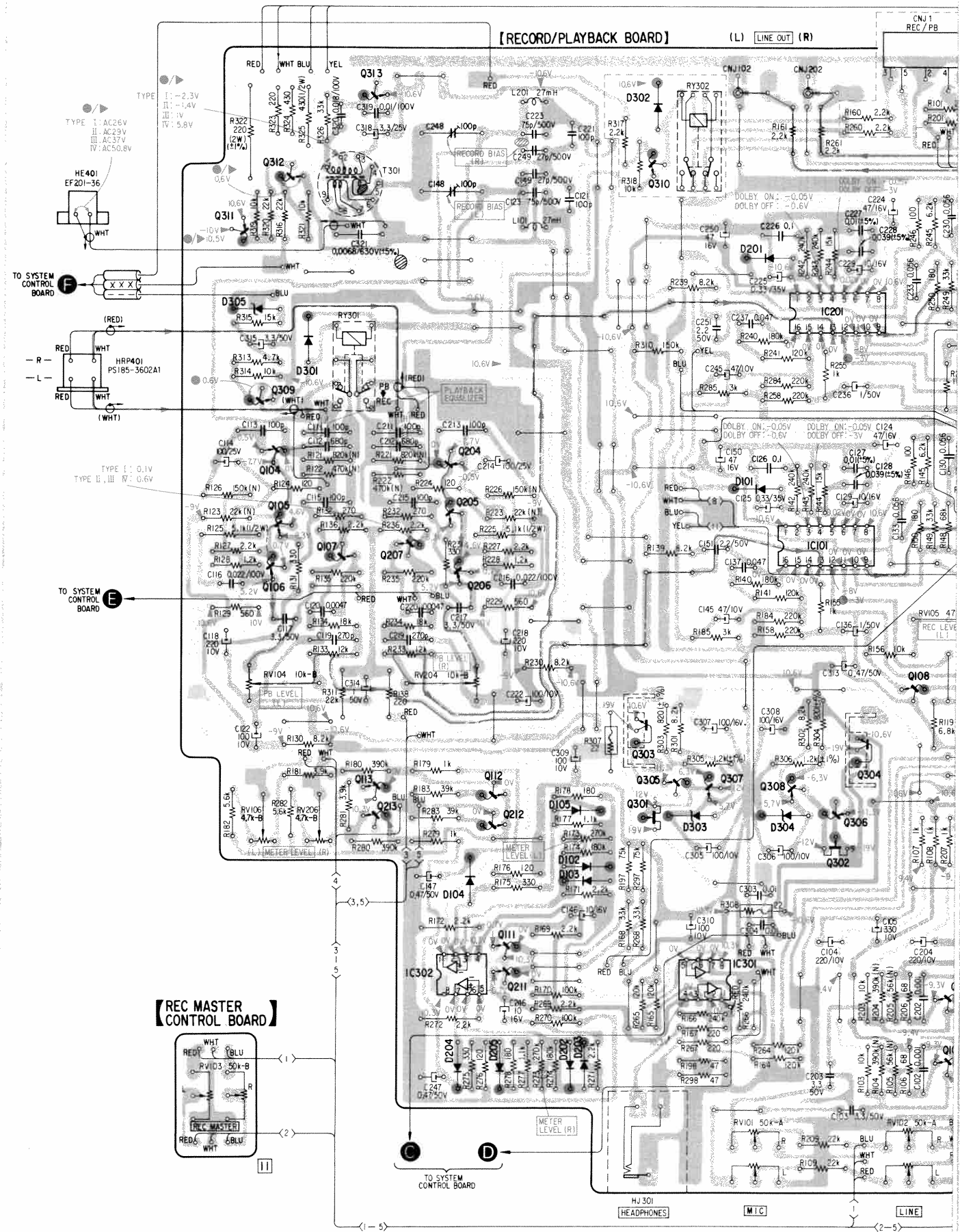

# TC-K65 TC-K65

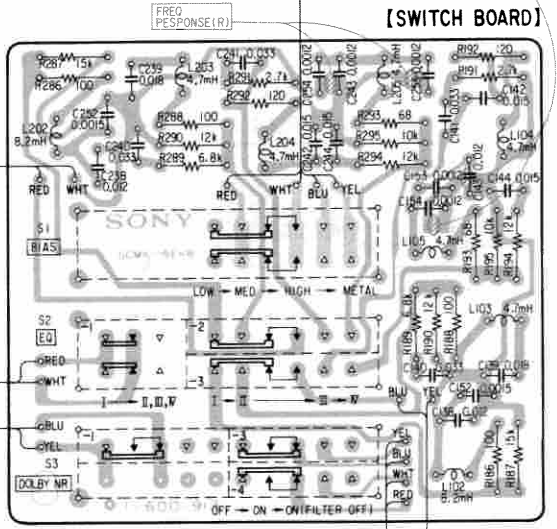
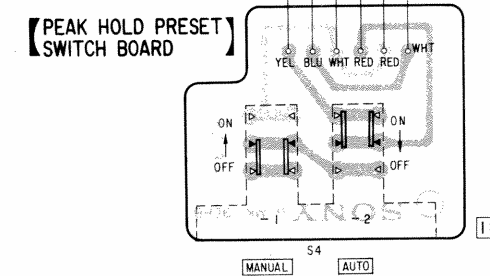
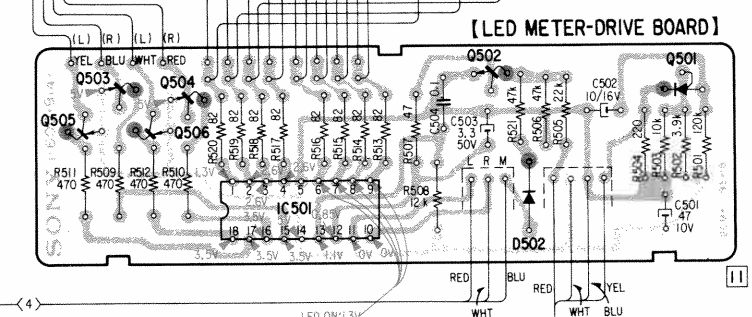
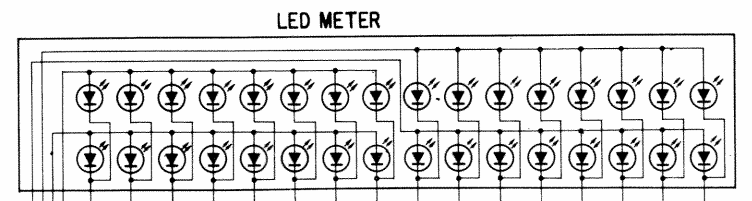
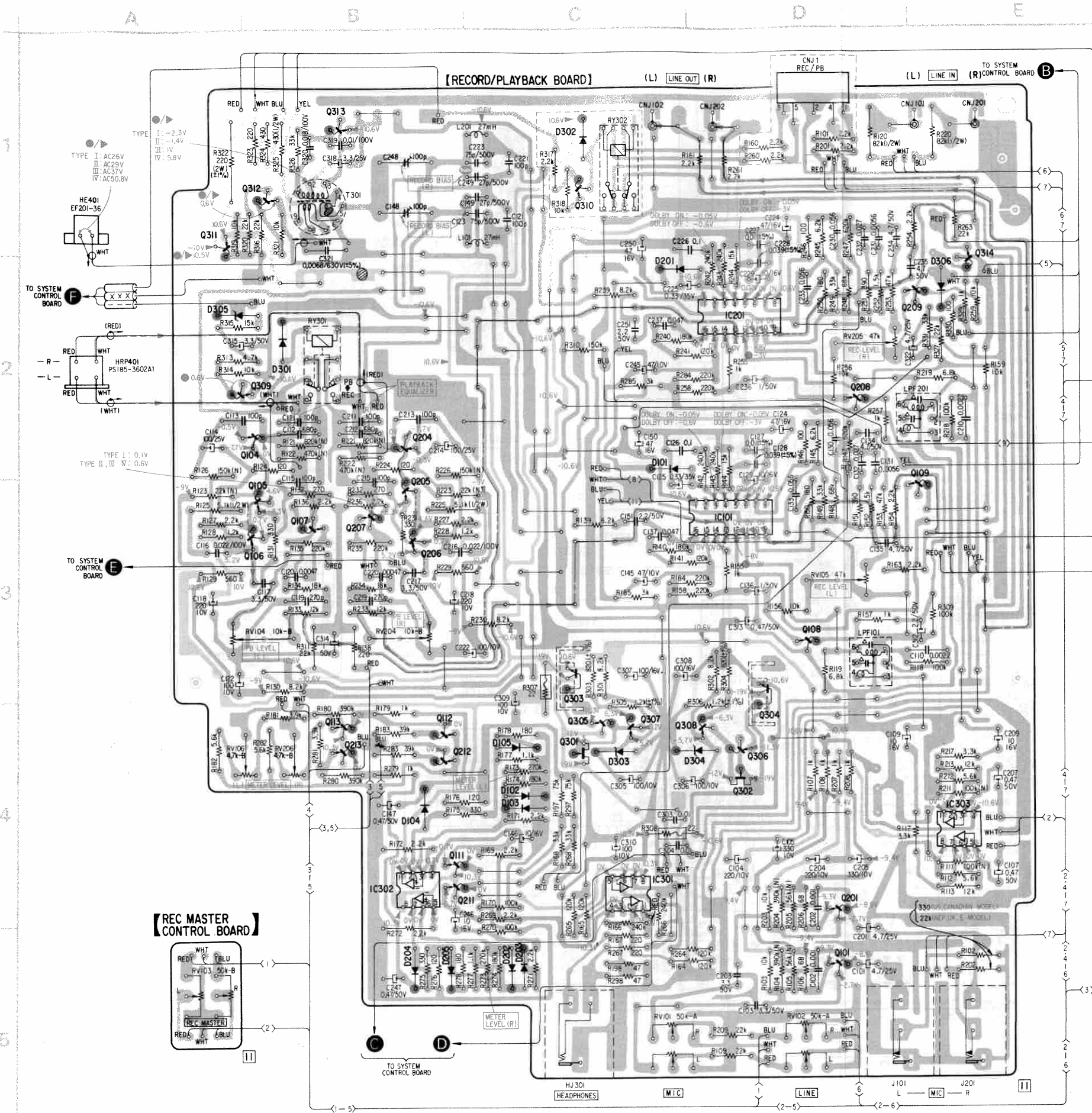

Q, IC	D
313	302
312	310
311	502 314 503 501 504 201 505 506 306 209 305 502 301
309	208
104	204
	101
205	109
105	107 207 IC101
106	206
	108
	303
	304
	305 307 308 113 112
	306 105 303 304
	302
	102 104 103
	IC303
	111
	IC302 211 IC301 201
	101
	204, 205, 202, 203
Q, IC	D

4.4. SCHEMATIC DIAGRAM — Audio Amp Section —

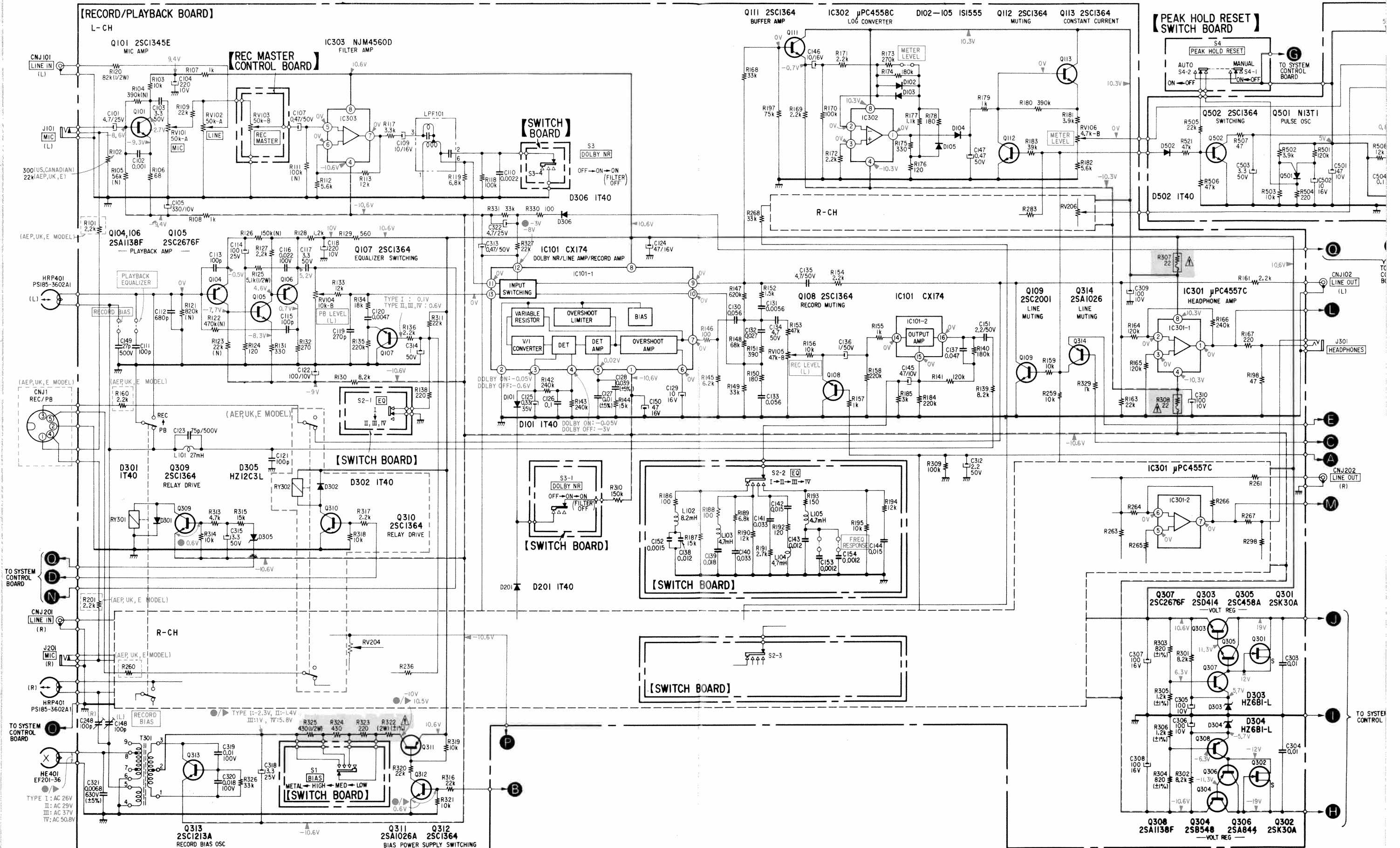



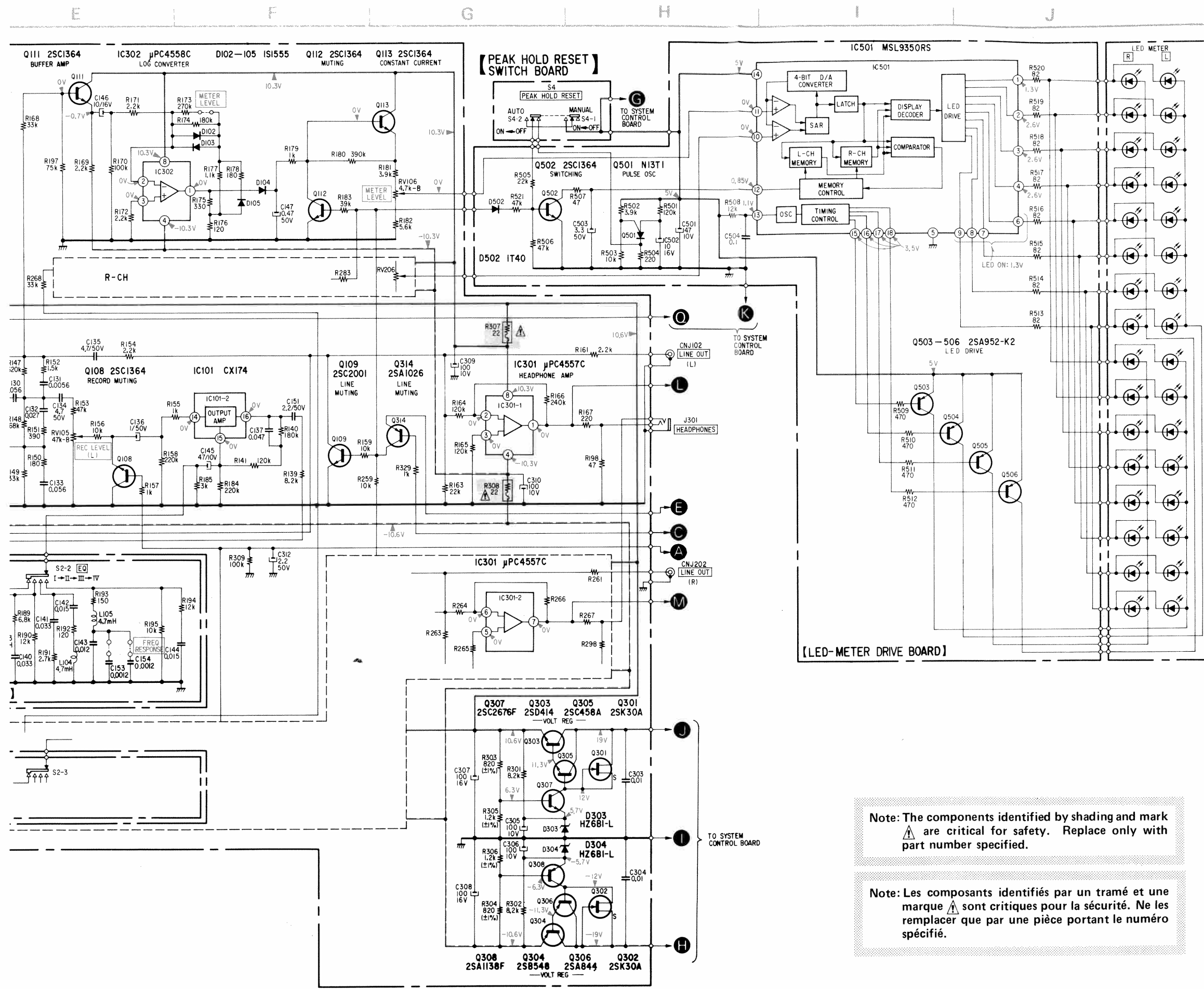

**Note:**

- Components for right channel have same values as for left channel. Reference numbers are coded from 200.
- All capacitors are in  $\mu\text{F}$  unless otherwise noted.  $\text{pF} = \mu\mu\text{F}$  50WV or less are not indicated except for electrolytics.
- All resistors are in ohms,  $\frac{1}{4}\text{W}$  unless otherwise noted.  $\text{k}\Omega : 1000 \Omega$ ,  $\text{M}\Omega = 1000 \text{k}\Omega$
- : fusible resistor.
- (N) : low-noise.
- : B+ bus.
- : B- bus.
- : panel designation.
- : adjustment for repair.
- Voltages are dc with respect to ground unless otherwise noted.
- Readings are taken under no signal conditions with a VOM (20  $\text{k}\Omega/\text{V}$ ).

no mark: STOP

- ▶ : FORWARD
- ▶▶ : FAST FORWARD
- ◀◀ : REWIND
- : RECORD
- : REC MUTE
- : PAUSE
- : STOP

- AC voltage readings in the bias oscillator circuit are taken with a VTVM.
- Voltage variations may be noted due to normal production tolerances.
- Switch

Ref. No.	Switch	Position
S1-1 to 1-4	BIAS	LOW
S2-1 to 2-4	EQ	I
S3-1 to 3-4	DOLBY NR	OFF
S4	PEAK HOLD RESET	AUTO

**Note:** The components identified by shading and mark are critical for safety. Replace only with part number specified.

**Note:** Les composants identifiés par un tramé et une marque sont critiques pour la sécurité. Ne les remplacer que par une pièce portant le numéro spécifié.

SECTION 5  
EXPLODED VIEWS

A B C D E  
1 2 3

- Note:**
- Items with no part number and/or no description are not stocked because they are seldom required for routine service.
  - All screws are Phillips (cross recess) type unless otherwise noted.
  - (-) = slotted head
  - Circled letters (A) to (Z) are applicable to European models only.

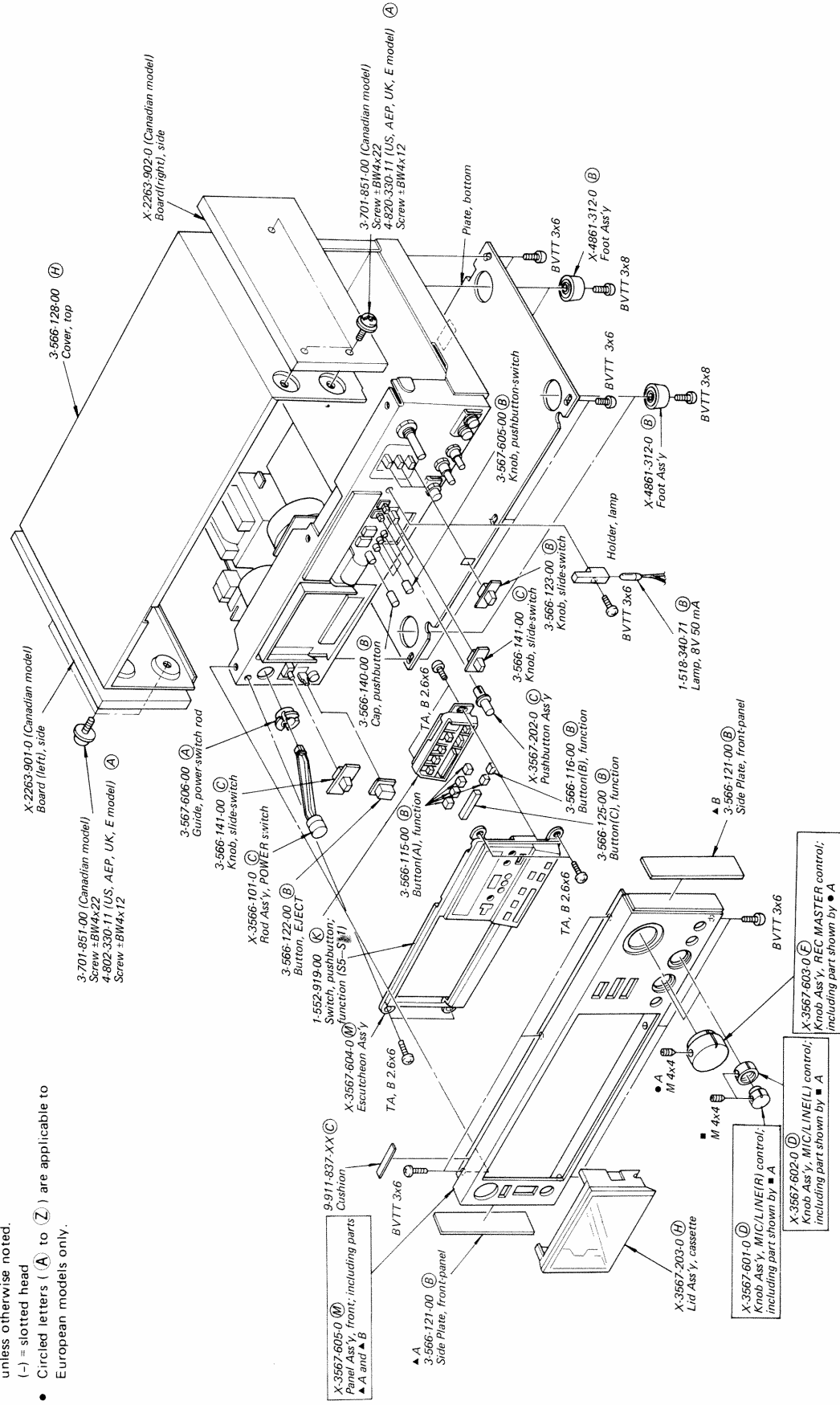

A B C D E  
1 2 3

- Note:**
- Items with no part number and/or no description are not stocked because they are seldom required for routine service.
  - All screws are Phillips (cross recess) type unless otherwise noted.
  - Circled letters (A) to (Z) are applicable to European models only.

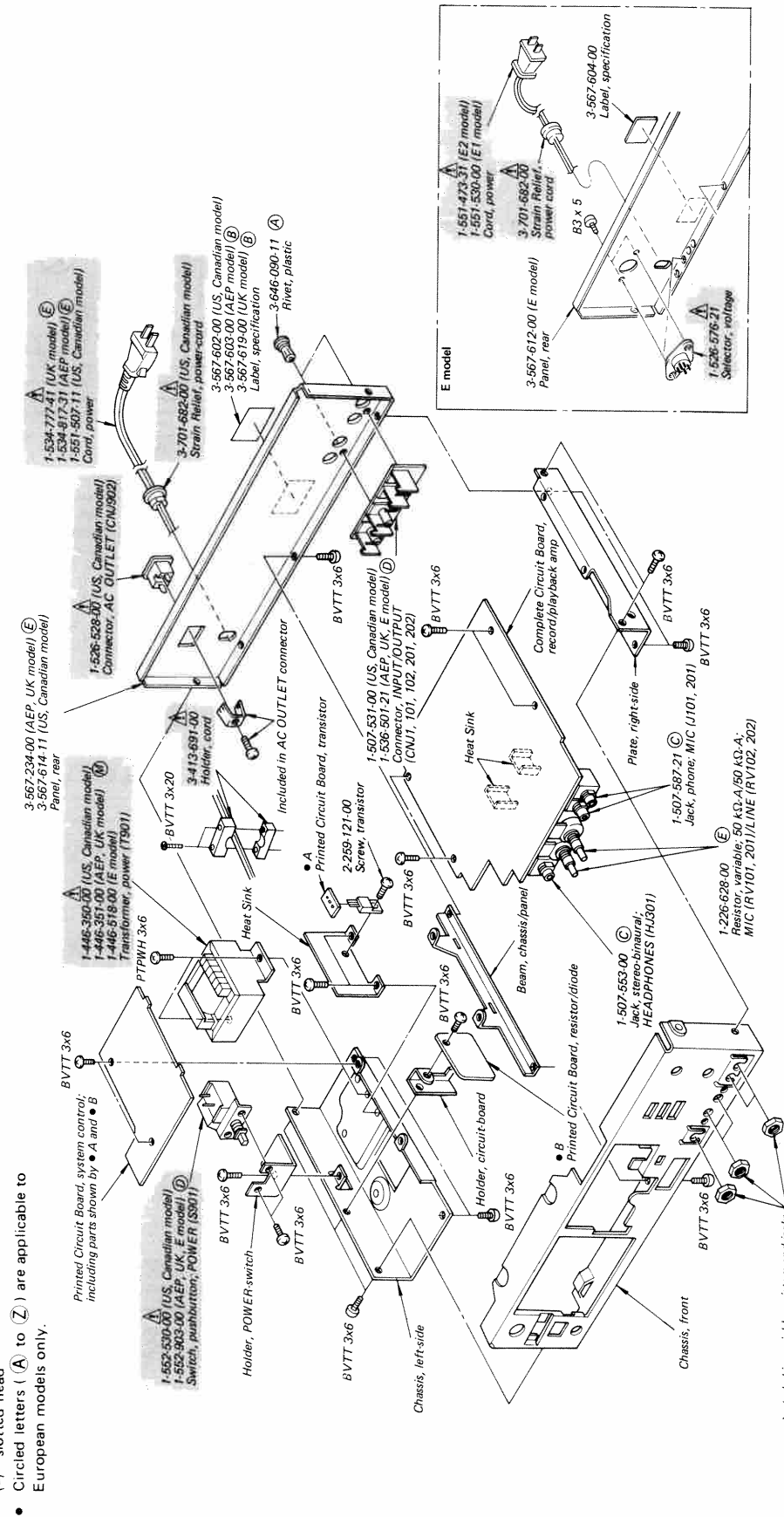

**Note:** Les composants identifiés par un trame et une marque **A** sont critiques pour la sécurité. Ne les remplacer que par une pièce portant le numéro spécifié.

**Note:** The components identified by shading and mark **A** are critical for safety. Replace only with part number specified.

A B C D E (3)

Note:

- Items with no part number and/or no description are not stocked because they are seldom required for routine service.
- All screws are Phillips (cross recess) type unless otherwise noted.
- (-) = slotted head
- (□□T) shows the number of coils in spring.
- Circled letters (A) to (Z) are applicable to European models only.

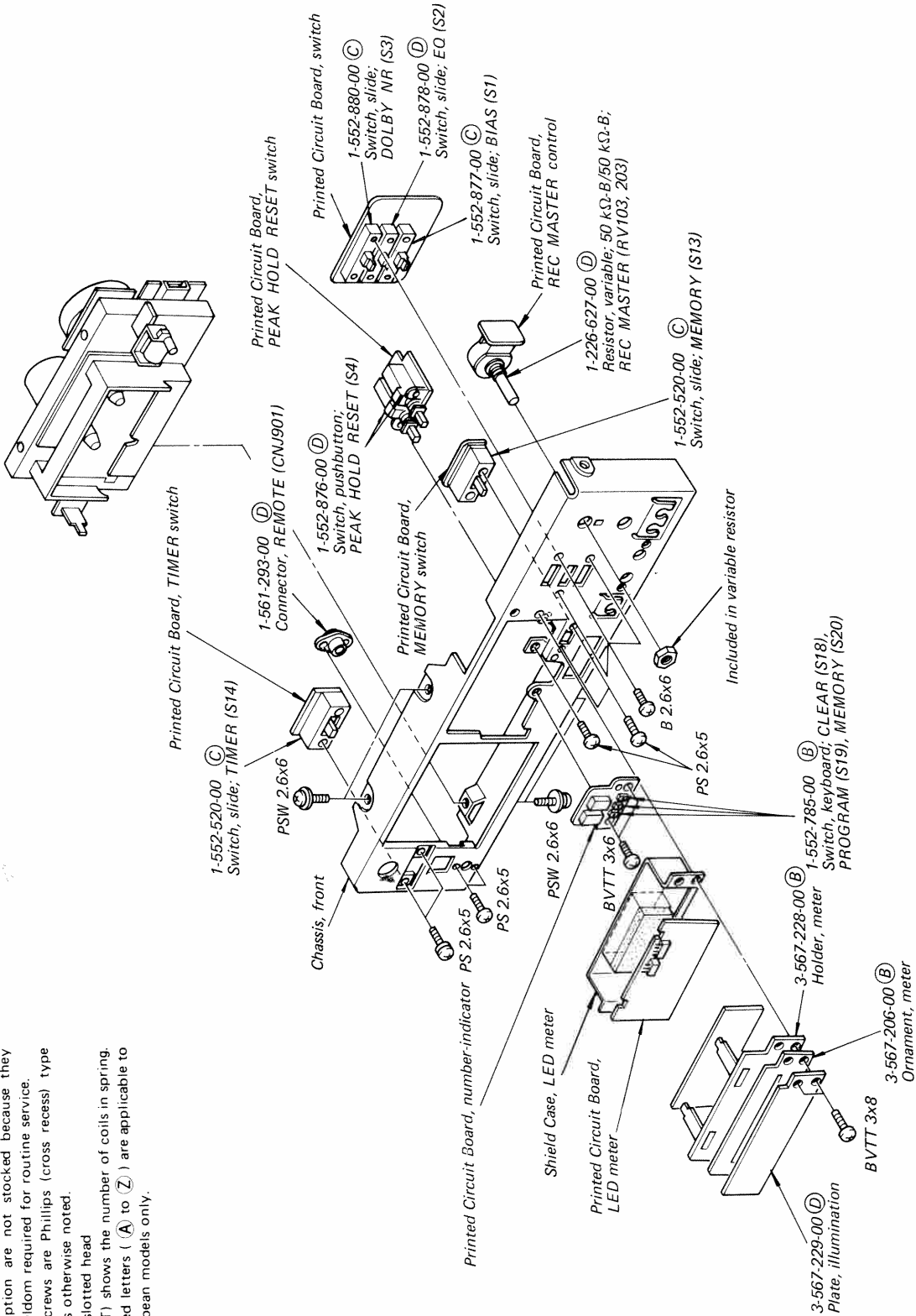

1

2

3



A | B | C | D | E (5)

Note:

- Items with no part number and/or no description are not stocked because they are seldom required for routine service.
- All screws are Phillips (cross recess) type unless otherwise noted.
- (-) = slotted head
- (□□T) shows the number of coils in spring.
- Circled letters (A) to (Z) are applicable to European models only.

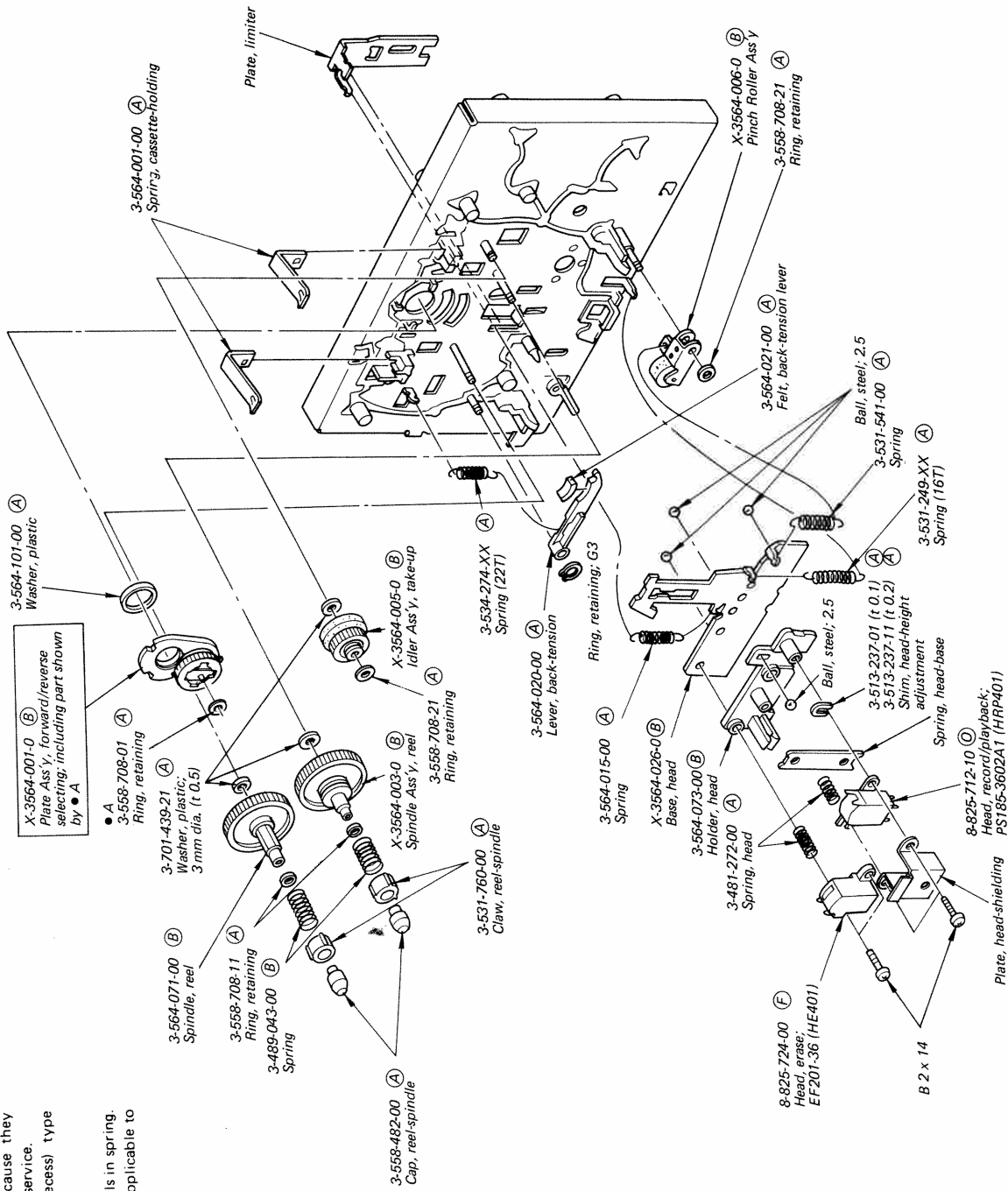

1

2

3

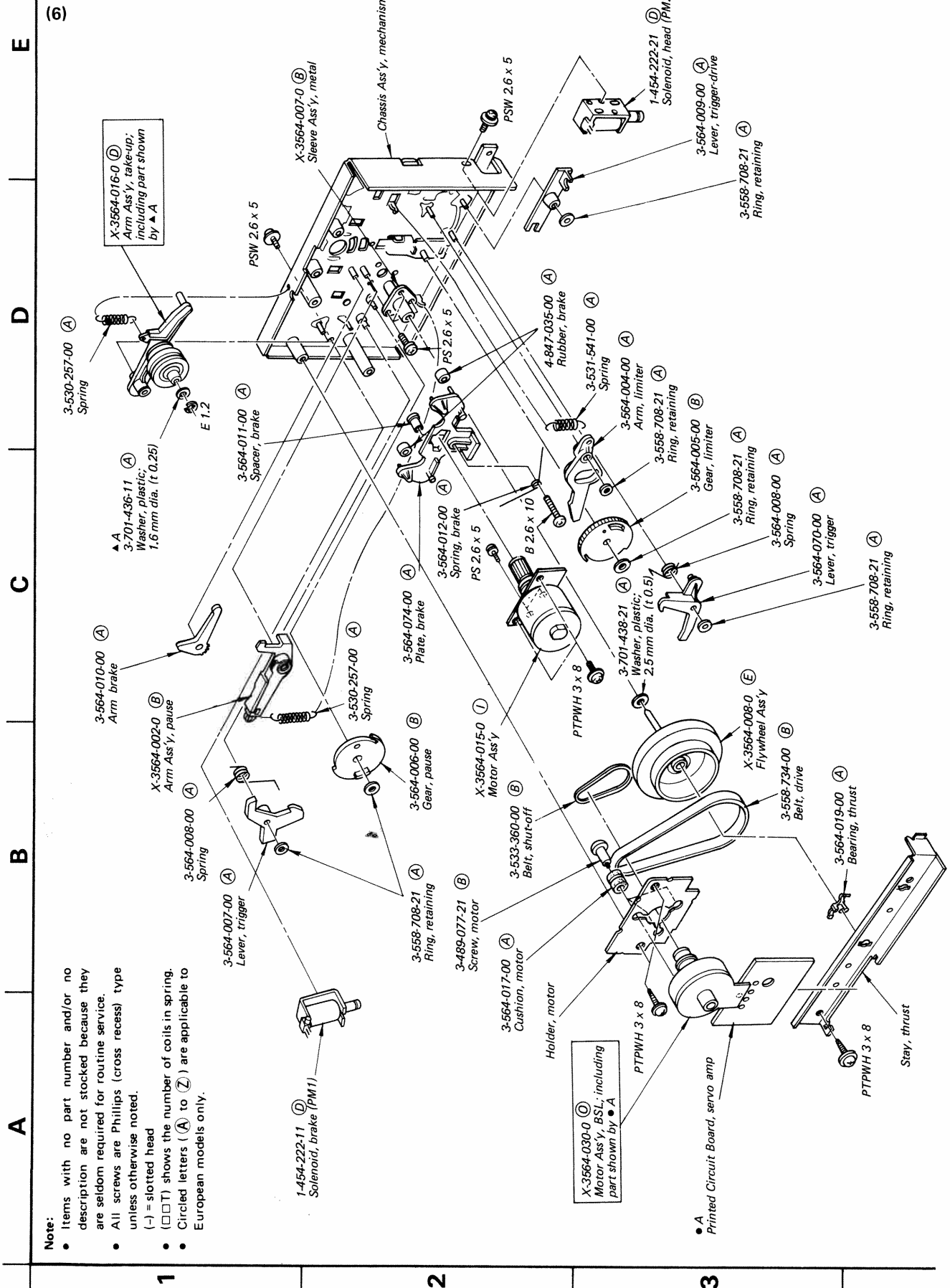

**Note:**

- Items with no part number and/or no description are not stocked because they are seldom required for routine service.
- All screws are Phillips (cross recess) type unless otherwise noted.
- (-) = slotted head
- (□□T) shows the number of coils in spring.
- Circled letters (A) to (Z) are applicable to European models only.

• A Printed Circuit Board, servo amp

A B C D E

(6)

1

2

3

**SECTION 6  
ELECTRICAL PARTS LIST**

Note: Circled letters (A) to (Z) are applicable to European models only.

<u>Ref. No.</u>	<u>Part No.</u>	<u>Description</u>
<b>SEMICONDUCTORS</b>		
<b>Transistors</b>		
⇒ Q101, 201	8-729-334-58	(B) 2SC1345
⇒ Q104, 204	8-729-113-82	(B) 2SA1138
⇒ Q105, 205	8-729-167-62	(B) 2SC2676
⇒ Q106, 206	8-729-113-82	(B) 2SA1138
Q107, 207	8-729-663-47	(C) 2SC1364
Q108, 208	8-729-663-47	(C) 2SC1364
⇒ Q109, 209	8-729-100-13	(B) 2SC2001
Q111, 211	8-729-663-47	(C) 2SC1364
Q112, 212	8-729-663-47	(C) 2SC1364
Q113, 213	8-729-663-47	(C) 2SC1364
Q301, 302	8-729-203-04	(B) 2SK30A
Q303	8-729-141-43	(B) 2SD414
Q304	8-729-154-83	(B) 2SB548
⇒ Q305	8-729-663-47	(C) 2SC1364
⇒ Q306	8-729-612-77	(B) 2SA1027R
⇒ Q307	8-729-167-62	(B) 2SC2676
⇒ Q308	8-729-113-82	(B) 2SA1138
Q309	8-729-663-47	(C) 2SC1364
Q310	8-729-663-47	(B) 2SC1364 (AEP, UK, E model)
⇒ Q311	8-729-612-77	(B) 2SA1027R
Q312	8-729-663-47	(C) 2SC1364
⇒ Q313	8-760-413-10	(B) 2SC1475
⇒ Q314	8-729-612-77	(B) 2SA1027R
Q501	8-729-101-31	(B) N13T1
Q502	8-729-663-47	(C) 2SC1364
⇒ Q503-506	8-729-195-23	(B) 2SA952
Q801	8-729-154-83	(B) 2SB548
Q802	8-729-141-43	(B) 2SD414
⇒ Q803	8-729-663-47	(C) 2SC1364
⇒ Q804	8-729-317-12	(E) 2SA671
Q805	8-729-201-52	(B) 2SA1015
⇒ Q806, 807	8-729-663-47	(C) 2SC1364
Q808	8-729-141-43	(B) 2SD414
Q809	8-729-201-52	(B) 2SA1015
Q810	8-729-154-83	(B) 2SB548

<u>Ref. No.</u>	<u>Part No.</u>	<u>Description</u>
⇒ Q811	8-729-663-47	(C) 2SC1364
Q812	8-729-156-43	(B) 2SB564
⇒ Q813, 814	8-729-100-13	(B) 2SC2001
⇒ Q815	8-729-612-77	(B) 2SA1027R
⇒ Q816-818	8-729-663-47	(C) 2SC1364
Q819	8-729-663-47	(C) 2SC1364
⇒ Q820, 821	8-729-663-47	(C) 2SC1364
⇒ Q822	8-729-201-52	(B) 2SA1015
⇒ Q823	8-729-612-77	(B) 2SA1027R
⇒ Q824	8-729-663-47	(C) 2SC1364
Q901	8-729-101-13	(C) PH103
⇒ Q1001, 1002	8-729-663-47	(C) 2SC1364
⇒ Q1003	8-760-335-10	(B) 2SC1474
⇒ Q1004	8-729-468-43	(C) 2SA684
⇒ Q1005	8-760-335-10	(B) 2SC1474
⇒ Q1006	8-729-468-43	(C) 2SA684
<b>ICs</b>		
IC101, 201	8-759-101-74	(H) CX174
⇒ IC301	8-759-745-60	(D) NJM4560D
IC302	8-759-145-58	(D) μPC4558C
IC303	8-759-745-60	(D) NJM4560D
⇒ IC501	8-759-993-50	(K) MSL9350
IC801	8-759-147-42	(K) μPD547C042
⇒ IC802	8-759-981-60	(L) MB8844-160
IC803, 804	8-759-904-69	(C) MSM4069
IC805	8-759-145-58	(D) μPC4558C
⇒ IC806	8-759-133-90	(F) μPC339C
IC1001	8-750-690-00	(D) CX069
⇒ IC1002	8-759-145-58	(D) μPC4558C
<b>Diodes</b>		
⇒ D101, 201	8-719-815-55	(B) 1S1555
D102-105	8-719-815-55	(B) 1S1555
D202-205	8-719-815-55	(B) 1S1555
⇒ D301	8-719-815-55	(B) 1S1555
⇒ D302	8-719-815-55	(B) 1S1555 (AEP, UK, E model)
⇒ D303, 304	8-719-910-65	(B) HZ6B2L
⇒ D305	8-719-910-28	(A) HZ12C2L
⇒ D306	8-719-815-55	(B) 1S1555

⇒ : Due to standardization, interchangeable replacements may be substituted for parts specified in the diagrams.

Note: Circled letters (A to Z) are applicable to European models only.

Ref. No.	Part No.	Description
D501	8-759-981-60 (L)	SEL8806
⇒D502	8-719-815-55 (B)	1S1555
<b>D801-809 (A) 8-719-200-02 (B) 10E2</b>		
⇒D810	8-719-910-23 (B)	HZ12A3L
D811	8-719-910-15 (B)	HZ11B2L
⇒D812	8-719-815-55 (B)	1S1555
D813	8-719-910-15 (B)	HZ11B2L
⇒D814	8-719-815-55 (B)	1S1555
⇒D815	8-719-910-23 (B)	HZ12A3L
D816	8-719-200-02 (B)	10E2
⇒D817	8-719-910-23 (B)	HZ12A3L
D818	8-719-200-02 (B)	10E2
⇒D819-822	8-719-151-77 (B)	RD5. 1E-C
⇒D823-832	8-719-815-55 (B)	1S1555
⇒D838	8-719-815-55 (B)	1S1555
⇒D839	8-719-151-77 (B)	RD5. 1E-C
D901	8-719-910-11 (B)	SR110
D902, 903	8-719-909-03 (F)	GL-9N03D
⇒D1001	8-719-910-65 (B)	HZ6B2L
<b>COILS AND TRANSFORMERS</b>		
L101, 201	1-408-262-00 (B)	27 mH microinductor
L102, 202	1-408-256-00 (B)	8.2 mH microinductor
L103-105	1-408-253-00 (B)	4.7 mH microinductor
L203-205	1-408-253-00 (B)	4.7 mH microinductor
T301	1-433-132-11 (B)	Transformer, bias osc
T901	(A) 1-446-350-00	Transformer, power (US, Canadian model)
	(A) 1-446-351-00 (M)	Transformer, power (AEP, UK model)
	(A) 1-446-518-00	Transformer, power (E model)
<b>CAPACITORS</b>		
All capacitors are in $\mu\text{F}$ and ceramic unless otherwise noted. 50 WV or less are not indicated except for electrolytics and tantalum. p : $\mu\text{F}$ , elect : electrolytic.		
C101, 201	1-123-332-00 (A)	4.7 25 V elect (low-noise)
C102, 202	1-161-323-00 (A)	0.001
C103, 203	1-123-231-00 (B)	3.3 50 V elect (nonpolarized)
C104, 204	1-121-420-00 (B)	220 10 V elect
C105, 205	1-121-805-00 (B)	330 10 V elect
C107, 207	1-121-911-00 (B)	0.47 50 V elect (low-noise)
C109, 209	1-121-651-00 (A)	10 16 V elect (low-noise)

⇒ : Due to standardization, interchangeable replacements may be substituted for parts specified in the diagrams.

Ref. No.	Part No.	Description
C110, 210	1-108-230-00 (A)	0.0022 mylar
C111, 211	1-102-973-00 (A)	100 p
C112, 212	1-161-321-00 (A)	680 p
C113, 213	1-102-973-00 (A)	100 p
C114, 214	1-121-416-00 (B)	100 25 V elect
C115, 215	1-102-973-00 (A)	100 p
C116, 216	1-129-776-00 (B)	0.022 100 V polypropylene
C117, 217	1-123-231-00 (B)	3.3 50 V elect (nonpolarized)
C118, 218	1-121-420-00 (B)	220 10 V elect
C119, 219	1-161-316-00 (A)	270 p
C120, 220	1-108-234-00 (A)	0.0047 mylar
C121, 221	1-102-106-00 (A)	100 p
C122, 222	1-121-414-00 (B)	100 10 V elect
C123, 223	1-107-167-00 (B)	75 p 500 V
C124, 224	1-121-409-00 (A)	47 16 V elect
C125, 225	1-131-212-00 (B)	0.33 35 V solid-tantalum
C126, 226	1-108-251-00 (B)	0.1 50 V mylar
C127, 227	1-108-239-00 (A)	0.01 mylar
C128, 228	1-108-360-00 (A)	0.039 mylar
C129, 229	1-121-651-00 (A)	10 16 V elect
C130, 230	1-108-361-00 (A)	0.056 mylar
C131, 231	1-108-355-00 (A)	0.0056 mylar
C132, 232	1-108-589-00 (A)	0.027 mylar
C133, 233	1-108-361-00 (A)	0.056 mylar
C134, 234	1-123-232-00 (B)	4.7 50 V elect (nonpolarized)
C135, 235	1-123-232-00 (B)	4.7 50 V elect (nonpolarized)
C136, 236	1-121-391-00 (A)	1 50 V elect
C137, 237	1-108-595-00 (A)	0.047 mylar
C138, 238	1-108-581-00 (B)	0.012 mylar
C139, 239	1-108-358-00 (A)	0.018 mylar
C140, 240	1-108-591-00 (A)	0.033 mylar
C141, 241	1-108-591-00 (A)	0.033 mylar
C142, 242	1-108-240-00 (B)	0.015 mylar
C143, 243	1-108-581-00 (B)	0.012 mylar
C144, 244	1-108-240-00 (B)	0.015 mylar
C145, 245	1-121-352-00 (A)	47 10 V elect
C146, 246	1-121-651-00 (A)	10 16 V elect
C147, 247	1-131-213-00 (B)	0.47 35 V solid-tantalum
C148, 248	1-141-225-00 (C)	100 p trimmer
C149, 249	1-107-157-00 (B)	27 p mica

Note: The components identified by shading and mark (A) are critical for safety. Replace only with part number specified.

Note: Les composants identifiés par un trame et une marque (A) sont critiques pour la sécurité. Ne les remplacer que par une pièce portant le numéro spécifié.



Note: Circled letters (A to Z) are applicable to European models only.

Ref. No.	Part No.	Description
C150, 251	1-121-409-00 (A) 47	16 V elect
C151, 251	1-123-230-00 (B) 2.2	50 V elect (nonpolarized)
C152, 252	1-108-228-00 (A) 0.0015	mylar
C153, 253	1-108-351-00 (B) 0.0012	mylar
C154, 254	1-108-351-00 (B) 0.0012	mylar
C301, 302	1-102-074-00 (A) 0.001	
C303, 304	1-108-239-00 (A) 0.01	mylar
C305, 306	1-121-414-00 (B) 100	10 V elect
C307, 308	1-121-415-00 (B) 100	16 V elect
C309, 310	1-121-414-00 (B) 100	10 V elect
C312	1-123-353-00 (B) 2.2	50 V elect
C313	1-121-726-00 (A) 0.47	50 V elect
C314	1-123-352-00 (B) 1	50 V elect
C315	1-123-354-00 (B) 3.3	50 V elect
C318	1-131-218-00 (A) 3.3	35 V solid-tantalum
C319	1-129-701-00 (A) 0.01	100 V polypropylene
C320	1-130-189-00 (B) 0.018	100 V polypropylene
C321	1-130-336-00 (B) 0.0068	630 V polypropylene
C322	1-123-328-00 (B) 4.7	25 V elect
C501	1-123-306-00 (B) 47	10 V elect
C502	1-121-651-00 (A) 10	16 V elect (low-noise)
C503	1-123-354-00 (B) 3.3	50 V elect
C504	1-108-251-00 (B) 0.1	mylar
C801, 802	1-123-337-00 (B) 1000	25 V elect
C803, 804	1-123-324-00 (B) 1000	16 V elect
C805	1-123-320-00 (B) 100	16 V elect
C806	1-108-239-00 (A) 0.01	mylar
C807	1-123-319-00 (B) 47	16 V elect
C808	1-123-329-00 (B) 10	25 V elect
C809	1-123-316-00 (B) 10	16 V elect
C810	1-123-307-00 (A) 100	10 V elect
C811	1-123-295-00 (B) 100	6.3 V elect
C812	1-123-319-00 (B) 47	16 V elect
C813	1-123-328-00 (B) 4.7	25 V elect
C814	1-108-239-00 (B) 0.01	mylar
C815	1-123-310-00 (B) 470	10 V elect
C816	1-123-352-00 (B) 1	50 V elect

Ref. No.	Part No.	Description
C817, 818	1-161-295-00 (B) 22 p	
C819-821	1-161-330-00 (B) 0.01	
C824, 825	1-161-051-00 (A) 0.01	
C826	1-123-353-00 (B) 2.2	50 V elect
C827	1-123-328-00 (B) 4.7	25 V elect
C828	1-123-353-00 (B) 2.2	50 V elect
C829	1-123-352-00 (B) 1	50 V elect
C830	1-123-351-00 (B) 0.47	50 V elect
C831	1-123-352-00 (B) 1	50 V elect
C832	1-108-591-00 (A) 0.033	
C833	1-123-316-00 (B) 10	16 V elect
C834	1-108-230-00 (B) 0.0022	mylar
C835	1-102-965-00 (B) 39 p	
C836	1-123-328-00 (B) 4.7	25 V elect
C837	1-123-352-00 (B) 1	50 V elect
C838	1-108-591-00 (A) 0.033	mylar
C839	1-108-239-00 (A) 0.01	mylar
C840	1-123-353-00 (B) 2.2	50 V elect
C841	1-101-888-00 (B) 68 p	
C843	1-108-591-00 (A) 0.033	mylar
C845	1-108-239-00 (A) 0.01	mylar
C1001, 1002	1-123-306-00 (B) 47	10 V elect
C1003	1-123-316-00 (B) 10	16 V elect
C1004	1-123-354-00 (B) 3.3	50 V elect
C1005	1-130-134-00 (B) 0.082	100 V plastic
C1006-1008	1-108-239-00 (A) 0.01	mylar
C1009	1-108-240-00 (B) 0.015	mylar

### RESISTORS

All resistors are in ohms. Common ¼W carbon resistors are omitted.

R120, 220	1-244-919-00 (A) 82 k	½W	
R125, 225	1-244-890-00 (A) 5.1 k	½W	
R303, 304	1-214-727-00 (A) 820	¼W	1% metal oxide
R305, 306	1-214-731-00 (A) 1.2 k	¼W	1% metal oxide
R307, 308	1-212-865-00 (A) 22	¼W	fusible
R322	1-206-648-00 (A) 220	2W	1% metal oxide
R323	1-246-457-00 (A) 220	¼W	
R324	1-246-464-00 (B) 430	¼W	
R325	1-244-864-00 (A) 430	½W	

Note: The components identified by shading and mark  are critical for safety. Replace only with part number specified.

Note: Les composants identifiés par un tramé et une marque  sont critiques pour la sécurité. Ne les remplacer que par une pièce portant le numéro spécifié.

**Note:** Circled letters (A to Z) are applicable to European models only.

Ref. No.	Part No.	Description
R801	△ 1-246-433-00 (A) 22 ¼ W	
R802	1-247-208-00 (A) 47 ½ W (nonflammable)	
R804	△ 1-247-224-00 (A) 220 ½ W (nonflammable)	
R809	1-247-184-00 (A) 2.2 ½ W (nonflammable)	
R810	△ 1-247-240-00 (A) 1 k ½ W (nonflammable)	
R815, 816	1-247-208-00 (A) 47 ½ W (nonflammable)	
R817	△ 1-212-962-00 (A) 15 ½ W fusible	

R1001	1-214-777-00 (A) 100 k ¼ W 1 % metal oxide
R1017, 1018	1-212-849-00 (A) 4.7 ¼ W fusible

RV101, 102)	1-226-628-00 (E) Variable, 50 kΩ-A/50 kΩ-A; MIC/LINE
RV201, 202)	
RV103, 203	1-226-627-00 (D) Variable, 50 kΩ-B/50 kΩ-B; REC MASTER
RV104, 204	1-224-645-XX (B) Adjustable, 10 kΩ-B; playback level
RV105, 205	1-224-647-XX (B) Adjustable, 47 kΩ-B; record level
RV106, 206	1-226-235-00 (A) Adjustable, 5 kΩ-B; meter level
RV1001	1-226-433-00 (B) Adjustable, 50 kΩ-B; tape speed

**SWITCHES**

S1	1-552-877-00 (C) Slide; BIAS
S2	1-552-878-00 (D) Slide; EQ
S3	1-552-880-00 (C) Slide; DOLBY NR
S4	1-552-876-00 (D) Pushbutton; PEAK HOLD RESET
S5-11	1-552-919-00 (K) Pushbutton; function

S12	Included in tape counter
S13	1-552-520-00 (C) Slide; MEMORY
S14	1-552-520-00 (C) Slide; TIMER
S15	1-552-268-00 (B) Slide; accidental erasure prevention
S16	1-552-268-00 (B) Slide; cassette lid

S18	1-552-785-00 (B) Keyboard; CLEAR
S19	1-552-785-00 (B) Keyboard; PROGRAM
S20	1-552-785-00 (B) Keyboard; MEMORY

S901	△ 1-552-530-00 Pushbutton; POWER (US, Canadian model)
	△ 1-552-903-00 (D) Pushbutton; POWER (AEP, UK, E model)

Ref. No. Part No. Description

**CONNECTORS**

CNJ1, 101, 102, 201, 202	) 1-536-501-21 (D)	Connector; LINE IN/LINE OUT (AEP, UK, E model)
CNJ101, 102, 201, 202		) 1-507-531-00

CNJ901	1-561-293-00 (D)	Connector; REMOTE
CNJ902	△ 1-526-528-00	Connector; AC OUTLET (US, Canadian model)

HJ301	1-507-553-00 (C)	Jack, stereo-binaural; HEADPHONES
J101, 201	1-507-587-21 (C)	Jack, phone; MIC

**MISCELLANEOUS**

CN1001	1-560-064-00 (B)	Pin, connector
CP901	△ 1-231-326-21	Encapsulated Component (US model)
	△ 1-231-341-00	Encapsulated Component (Canadian, E model)
CP902	△ 1-130-267-00 (C)	Encapsulated Component (UK, AEP model)

HE401	8-825-724-00 (F)	Head, erase; EF201-36
-------	------------------	-----------------------

HRP401	8-825-712-10 (O)	Head, record/playback; PS185-3602A1
LPF101, 201	1-231-388-00 (D)	Filter, low-pass
M1	X-3564-030-0 (O)	Motor Ass'y, BSL; capstan
M2	X-3564-015-0 (I)	Motor Ass'y, reel
PL1, 2	1-518-340-71 (B)	Lamp; cassette compartment/meter

PM1	1-454-222-11 (D)	Solenoid, brake
PM2	1-454-222-21 (D)	Solenoid, head
RY301	1-515-323-00 (G)	Relay
RY302	1-515-297-00 (F)	Relay (AEP, UK, E model)
	△ 1-526-576-21 (E)	Selector, voltage (E model)

	△ 1-534-777-41 (E)	Cord, power (UK model)
	△ 1-534-817-31 (E)	Cord, power (AEP model)
	1-548-537-12 (G)	Counter, tape (includes switch S12)
	△ 1-551-473-31 (C)	Cord, power (E2 model)
	△ 1-551-507-11	Cord, power (US, Canadian model)

	△ 1-551-530-00	Cord, power (E1 model)
	1-560-064-00 (B)	Pin, connector
	1-561-378-00 (A)	Connector, 3-pin
	1-561-379-00 (A)	Connector, 4-pin
	1-561-380-00 (A)	Connector, 5-pin

**Note:** The components identified by shading and mark △ are critical for safety. Replace only with part number specified.

**Note:** Les composants identifiés par un trame et une marque △ sont critiques pour la sécurité. Ne les remplacer que par une pièce portant le numéro spécifié.

**Note:** Circled letters ( **A** ) to ( **Z** ) are applicable to European models only.

**ACCESSORIES AND PACKING MATERIALS**

<u>Part No.</u>	<u>Description</u>
X-3701-105-0	(A) Tip Ass'y, head-cleaning
3-429-126-00	(B) Bag, plastic
3-561-142-00	Cushion, top-front (Canadian model)
3-561-143-00	Cushion, top-rear (Canadian model)
3-561-144-00	Cushion, bottom-right (Canadian model)
3-561-145-00	Cushion, bottom-left (Canadian model)
3-566-148-00	(B) Cushion, top-front (US, AEP, UK, E model)
3-566-149-00	(B) Cushion, top-rear (US, AEP, UK, E model)
3-566-150-00	(B) Cushion, bottom-right (US, AEP, UK, E model)
3-566-151-00	(B) Cushion, bottom-left (US, AEP, UK, E model)
3-567-617-00	(D) Carton (US, AEP, UK, E model)
3-567-618-00	Carton (Canadian model)
3-701-630-00	(A) Bag, plastic
3-701-684-11	(B) Card, voltage (E model)
3-701-811-01	(B) Slip, cassette-caution
3-770-925-11	(F) Manual, instruction (AEP, UK model)
3-770-925-21	Manual, instruction (US model)
3-770-925-21	(C) Manual, instruction (Canadian model)
3-794-539-31	(D)
3-793-828-11	(B) Card, cassette-caution (US, Canadian, E model)
3-794-233-11	Slip (US model)
4-818-924-00	(B) Bag, plastic (US, AEP, UK, E model)