

ST-S120

SERVICE MANUAL

*Canadian Model
AEP Model
E Model
East European Model*



SPECIFICATIONS

Tuner		Capture ratio	1.0 dB
Circuit system	FM stereo, FM/AM superheterodyne tuner Quartz-locked PLL digital synthesizer system	AM suppression ratio	65 dB
		Image response ratio	70 dB
FM tuner		IF response ratio	70 dB
Frequency range	87.5 – 108 MHz EE1 (East European) model: 65 – 74 MHz 87.5 – 108 MHz	Spurious response ratio	80 dB
Antenna terminals	75 ohms unbalanced 300 ohms balanced AEP, EE1 model: 75 ohms unbalanced	Muting threshold	30 dBf
Intermediate frequency	10.7 MHz	Automatic tuning threshold	30 dBf
Sensitivity (at 46 dB quieting)	18.0 dBf, 4.4 μ V (mono) 40.0 dBf, 49 μ V (stereo) AEP, EE1 model: 18.0 dBf, 2.2 μ V (mono) 40.0 dBf, 24.5 μ V (stereo)	output	775 mV, 4.7 kohms (at 75 kHz deviation) AEP, EE1 model: 410 mV, 5.7 kohms (at 40 kHz deviation)
Sensitivity (at 50 dB quieting)	22.1 dBf, 7 μ V (mono) 42.1 dBf, 70 μ V (stereo)	AM tuner	
Usable sensitivity (IHF)	19.5 dBf (5 μ V)	Frequency range	Italian model: MW: 522 – 1,611 kHz LW: 144 – 288 kHz AEP, EE1 model: MW: 531 – 1,602 kHz LW: 153 – 279 kHz Canadian model: AM: 530 – 1,710 kHz at 10 kHz step (531 – 1,710 kHz at 9 kHz step) E model: AM: 531 – 1,602 kHz at 9 kHz step (530 – 1,710 kHz at 10 kHz step)
Signal-to-noise ratio (at 40 kHz deviation)	74 dB (mono) 69 dB (stereo)	Antenna	AM loop antenna External antenna terminal
Signal-to-noise ratio (at 75 kHz deviation)	80 dB (mono) 75 dB (stereo)	Intermediate frequency	450 kHz
Harmonic distortion	0.3% (mono), 0.5% (stereo) (at 1 kHz)	Usable sensitivity (with AM loop antenna)	300 μ V/m (999 kHz) 1 mV/m (216 kHz)
Separation	40 dB (at 1 kHz)	Signal-to-noise ratio	54 dB (50 mV/m) (999 kHz) 50 dB (50 mV/m) (216 kHz)
Frequency response	30 Hz – 15 kHz \pm 0.5 dB AEP, EE1 model: 40 Hz – 12.5 kHz \pm 0.5 dB	Harmonic distortion	0.5% (50 mV/m, 400 Hz)
Selectivity	West German and Italian models: 65 dB (at 300 kHz) AEP, EE1 model: 60 dB (at 300 kHz) 80 dB (at 400 kHz) other models: 65 dB (at 400 kHz)	Selectivity	32 dB

— Continued on next page —

FM STEREO/FM-AM TUNER
SONY®

General

Power requirements

AEP, EE1 model: 220 V AC (or 240 V AC Adjustable by authorized Sony personnel), 50/60 Hz
 Canadian model: 120 V AC, 60 Hz
 E model: 110 — 120 V or 220 — 240 V AC adjustable, 50/60 Hz

Power consumption

10 W

Dimensions

Approx. 430×85×295 mm (w/h/d)
 (17×3³/₈×11¹/₈ inches)

Weight

Approx. 2.8 kg (6 lb 3 oz)

Accessories supplied

- Remote control cord (1)
- Connecting cord (1)
- FM antenna (1) (Except West Germany model)
- AM loop antenna (1)

Design and specifications subject to change without notice.

MODEL IDENTIFICATION

— *Specification Label* —

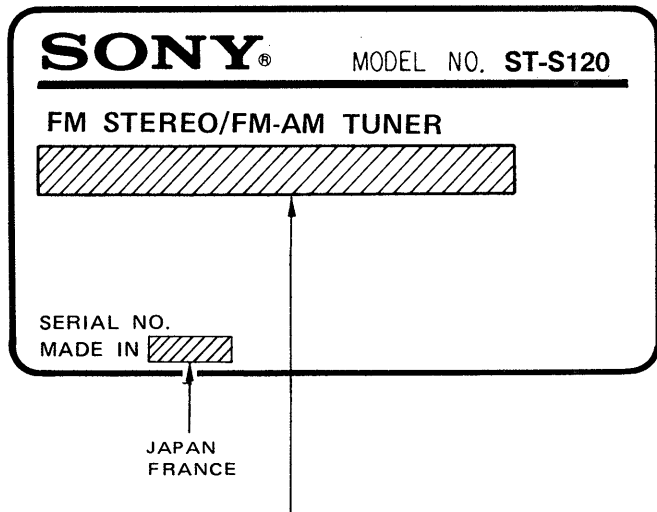

Canadian Model: AC: 120 V 60 Hz 10 W
 AEP, EE1 Model: AC: 220 V 50/60 Hz 10 W
 E Model: AC: 110 — 120 V/220 — 240 V
 50/60 Hz 10 W

On safety

- Before connecting the unit to the power source, check that the operating voltage of your unit is the same as the local power line voltage.

Where purchased	Operating voltage
Canadian Model	120 V AC, 60 Hz
AEP, EE1 Model	220 V AC, 50/60 Hz (240 V AC, adjustable by authorized Sony personnel)
E Model	110–120 or 220–240 V AC, 50/60 Hz (Adjustable using the voltage selector at the rear)

- Should any solid object or liquid fall into the unit, unplug the unit and have it checked by qualified personnel before operating it an further.
- Unplug the unit from the wall outlet if it is not to be used for an extended period of time. To disconnect the cord, pull it out by grasping the plug. Do not pull the cord itself.

SAFETY-RELATED COMPONENT WARNING!!

COMPONENTS IDENTIFIED BY MARK OR DOTTED LINE WITH MARK ON THE SCHEMATIC DIAGRAMS AND IN THE PARTS LIST ARE CRITICAL TO SAFE OPERATION. REPLACE THESE COMPONENTS WITH SONY PARTS WHOSE PART NUMBERS APPEAR AS SHOWN IN THIS MANUAL OR IN SUPPLEMENTS PUBLISHED BY SONY.

ATTENTION AU COMPOSANT AYANT RAPPORT À LA SÉCURITÉ!

LES COMPOSANTS IDENTIFIÉS PAR UNE MARQUE SUR LES DIAGRAMMES SCHÉMATIQUES ET LA LISTE DES PIÈCES SONT CRITIQUES POUR LA SÉCURITÉ DE FONCTIONNEMENT. NE REMPLACER CES COMPOSANTS QUE PAR DES PIÈCES SONY DONT LES NUMÉROS SONT DONNÉS DANS CE MANUEL OU DANS LES SUPPLÉMENTS PUBLIÉS PAR SONY.

SECTION 1 GENERAL

Receiving Broadcasts

Tuning in Automatically

Before reception, be sure to connect the AM and FM antenna.

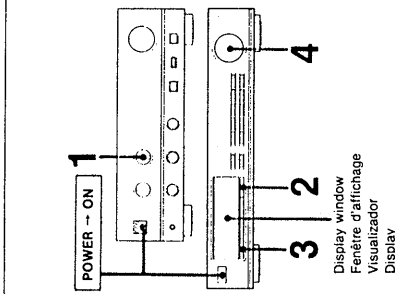

To receive other stations
When the received station is not the one you want, turn TUNING again.

Indications in the display window

- The STEREO indication appears when an FM stereo program of sufficient signal strength is received.
- The SIGNAL meter indicates the signal strength of a station tuned in.

To change the AM tuning interval (except European and U.K. models)

The AM tuning interval is preset at the factory to 10 kHz or to 9 kHz to match the frequency allocation system of your country. To change the interval, proceed as follows.

- 1 Depress the POWER switch to turn on the system.
- 2 Press the BAND selector to select AM.
- 3 Press the POWER switch to turn off the system.
- 4 While turning the TUNING knob fully toward "+", press the POWER switch to turn on the system stored.

To reset the interval, follow the same procedure.

Note

When the interval is changed, all stored stations will be erased.
After changing the interval, be sure to store the stations again.

Réception d'une émission

Accord automatique

Avant la réception, s'assurer de connecter l'antenne AM et l'antenne FM.

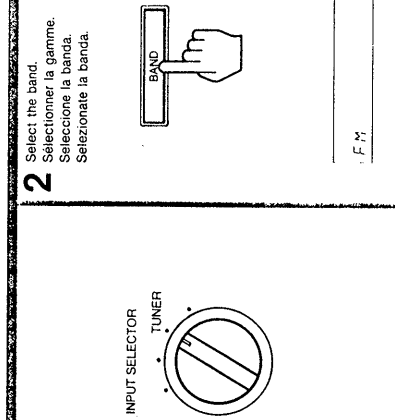

Reception d'autres stations
Lorsque la station accordée n'est pas celle désirée, appuyer de nouveau sur TUNING.

Temoins dans la fenêtre d'affichage

- Le témoin STEREO apparaît lorsqu'un programme stéréo avec un signal suffisamment fort est reçu.
- L'intensité du signal de la station accordée est indiquée par l'indicateur SIGNAL.

Changement de l'intervalle d'accord AM (excepté les modèles pour l'Europe continentale et le Royaume-Uni)

L'intervalle d'accord AM a été pré réglé en usine sur 10 ou 9 kHz pour coïncider avec l'allocation des fréquences dans la région d'utilisation. Pour modifier l'intervalle, procéder comme suit.

- 1 Appuyer sur le commutateur POWER pour mettre le système sous tension.
- 2 Appuyer sur le sélecteur FM/AM BAND pour sélectionner AM.
- 3 Appuyer de nouveau sur le commutateur POWER pour mettre le système hors tension.
- 4 Tout en tournant le réglage TUNING vers "+", appuyer sur le commutateur POWER pour retourner l'alimentation.

Pour réinitialiser l'intervalle, répéter les mêmes démarches.

Remarque

Lorsque l'intervalle est modifié, toutes les stations mémorisées sont effacées.
Après avoir changé l'intervalle, s'assurer de mémoriser les stations.

Radiorecepción

Sintonía automática

Antes de la recepción, asegúrese de conectar las antenas de AM y FM suministradas.

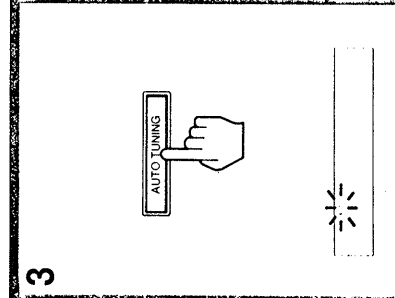

Para recibir otras emisoras
Cuando la emisora recibida no es la deseada, vuelva a girar TUNING.

Indicaciones en el visualizador

- Cuando reciba un programa de FM estereo de señal suficientemente intensa, aparecerá la indicación STEREO.
- En el indicador SIGNAL aparecerá la intensidad de señal de la emisora recibida.

Para cambiar el intervalo de sintonía de AM (excepto los modelos para Europa continental y el Reino Unido)

El intervalo de sintonía de AM ha sido ajustado en fábrica a 10 kHz o 9 kHz para ajustarse al sistema de asignación de frecuencias de su país. Para cambiar el intervalo, realice lo siguiente.

- 1 Presione el interruptor POWER a fin de conectar la alimentación del sistema.
- 2 Presione el selector BAND para seleccionar AM.
- 3 Presione el interruptor POWER para desconectar la alimentación del sistema.
- 4 Mientras el mando TUNING esté completamente girado hacia "+", presione el interruptor POWER a fin de conectar la alimentación del sistema.

Para reajustar el intervalo, realice los mismos procedimientos.

Note

Cuando cambie el intervalo, se borrarán todas las emisoras almacenadas.
Después de cambiar el intervalo, vuelva a almacenar las emisoras.

Ricezione radiofonica

Sintonia automatica

Prima di usare la radio, assicuratevi di collegare le antenne AM e FM.

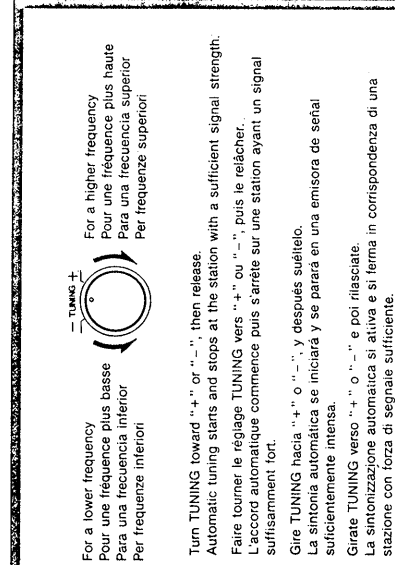

Per ricevere altre stazioni
Se la stazione sintonizzata non è quella desiderata, girate di nuovo TUNING.

Indicazioni sul display

- L'indicazione STEREO appare sul display quando viene ricevuta una trasmissione FM stereo con sufficiente forza di segnale.
- Il misuratore SIGNAL indica la forza di segnale della stazione ricevuta.

Per cambiare l'intervallo di sintonia AM (tranne i modelli per l'Europa e il Regno Unito)

L'intervallo di sintonia AM è stato prerogolato in fabbrica su 10 kHz o 9 kHz in corrispondenza all'allocation delle frequenze in uso nel vostro paese. Per cambiare l'intervallo procedete come segue.

- 1 Premete POWER per accendere l'apparecchio.
- 2 Premete il selettore BAND per selezionare AM.
- 3 Premete di nuovo POWER per spegnere l'apparecchio.
- 4 Mentre girate completamente la manopola TUNING verso "+", premete POWER per accendere l'apparecchio.

Per riportare l'intervallo alla regolazione originale seguite lo stesso procedimento.

Nota

Cuando cambiate l'intervallo, tutte le stazioni memorizzate vengono cancellate dalla memoria.
Assicuratevi di memorizzare di nuovo le stazioni dopo aver cambiato l'intervallo.

SECTION 2

ELECTRICAL ADJUSTMENTS

2-1. FM SECTION

FM NULL Adjustment

Setting :
BAND switch : FM

Procedure :

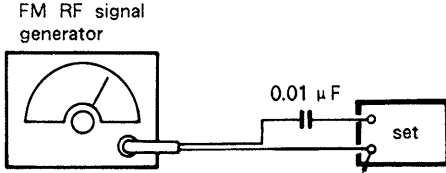

FM antenna terminal
AEP, UK, West Germany,
Italian model : 75 Ω
Canadian, E model : 300 Ω

Carrier frequency : 98 MHz
Output level : 1 mV (60 dB)
Modulation : 1 kHz, 40 kHz deviation (100%)
(AEP, West Germany, Italian, EE1 model)
1 kHz, 75 KHz deviation (100%)
(Canadian, E model)

1. Tune the set to 98 MHz.
2. Adjust T21 for a 0 V reading on the VOM.

Note : When the ceramic filter is replaced, these adjustments should be made.

VOM
(range : 2.5 V DC)

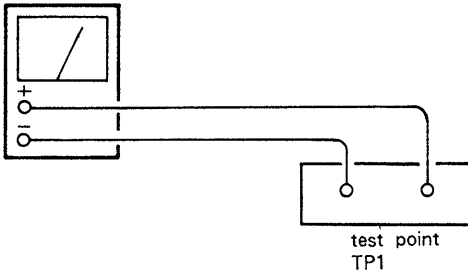

STEREO Indication Lighting Level Adjustment

Setting :
STEREO/MUTE switch : OFF
BAND switch : FM

Procedure :

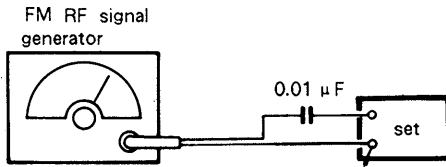

FM antenna terminal
AEP, West Germany, EE1,
Italian model : 75 Ω
Canadian, E model : 300 Ω

Carrier frequency : 98 MHz
Output level : 17.9 μV (25 dB)
Mode : Stereo

Modulation :
Audio (1 kHz) : 33.75 kHz deviation (45%)
Pilot (19 kHz) : 7.5 kHz deviation (10%)
Sub-channel (38 kHz) : 33.75 kHz deviation (45%) } Canadian, E model
Audio (1 kHz) : 16.25 kHz deviation (40.625%)
Pilot (19 kHz) : 7.5 kHz deviation (18.75%)
Sub-channel (38 kHz) : 16.25 kHz deviation (40.625%) } AEP, EE1, West Germany, Italian model

1. Tune the set to 98 MHz.
2. Adjust RV24 so that the STEREO indicator goes on.

FM Stereo Separation Adjustment

Setting :
STEREO/MUTE switch : ON (STEREO)
BAND switch : FM

Procedure :

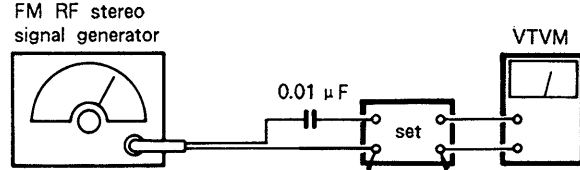

FM antenna terminal
OUTPUT terminal
AEP, West Germany, EE1,
Italian model : 75 Ω
Canadian, E model : 300 Ω

Carrier frequency : 98 MHz
Output level : 1 mV (60 dB)
Mode : Stereo

Modulation :
Audio (1 kHz) : 33.75 kHz deviation (45%)
Pilot (19 kHz) : 7.5 kHz deviation (10%)
Sub-channel (38 kHz) : 33.75 kHz deviation (45%) } Canadian, E model
Audio (1 kHz) : 16.25 kHz deviation (40.625%)
Pilot (19 kHz) : 7.5 kHz deviation (18.75%)
Sub-channel (38 kHz) : 16.25 kHz deviation (40.625%) } AEP, EE1, West Germany, Italian model

FM stereo signal generator output channel	VTVM connection	VTVM reading (dB)
L-CH	L-CH	(A)
R-CH	L-CH	(B) Adjust RV21 for minimum reading.
R-CH	R-CH	(C)
L-CH	R-CH	(D) Adjust RV21 for minimum reading.

L-CH Stereo separation : (A) - (B)
R-CH Stereo separation : (C) - (D)

The separations of both channels should be equal.

2-2. AM SECTION

SIGNAL LEVEL METER Lighting Level Adjustment

Setting:

BAND switch : AM (Canadian, E model)
LW (AEP, West Germany, Italian, EE1 model)

Procedure :

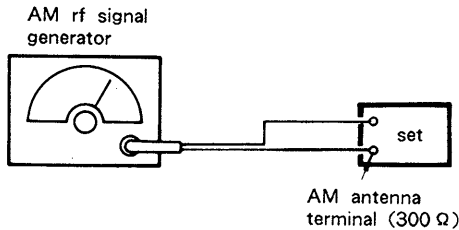

Carrier frequency : 999 kHz (Canadian, E, EE1 model)
216 kHz
(AEP, West Germany, Italian model)
Output level : 94 dB μ /m
Modulation : 400 Hz, 30% modulation

1. Tune the set to 999 kHz (Canadian, E, EE1 model) or 216 kHz (AEP, West Germany, Italian model).
2. Adjust RV23 until the scale-5 on SIGNAL METER indicator lights up.

2-3. ADJUSTING PARTS LOCATION

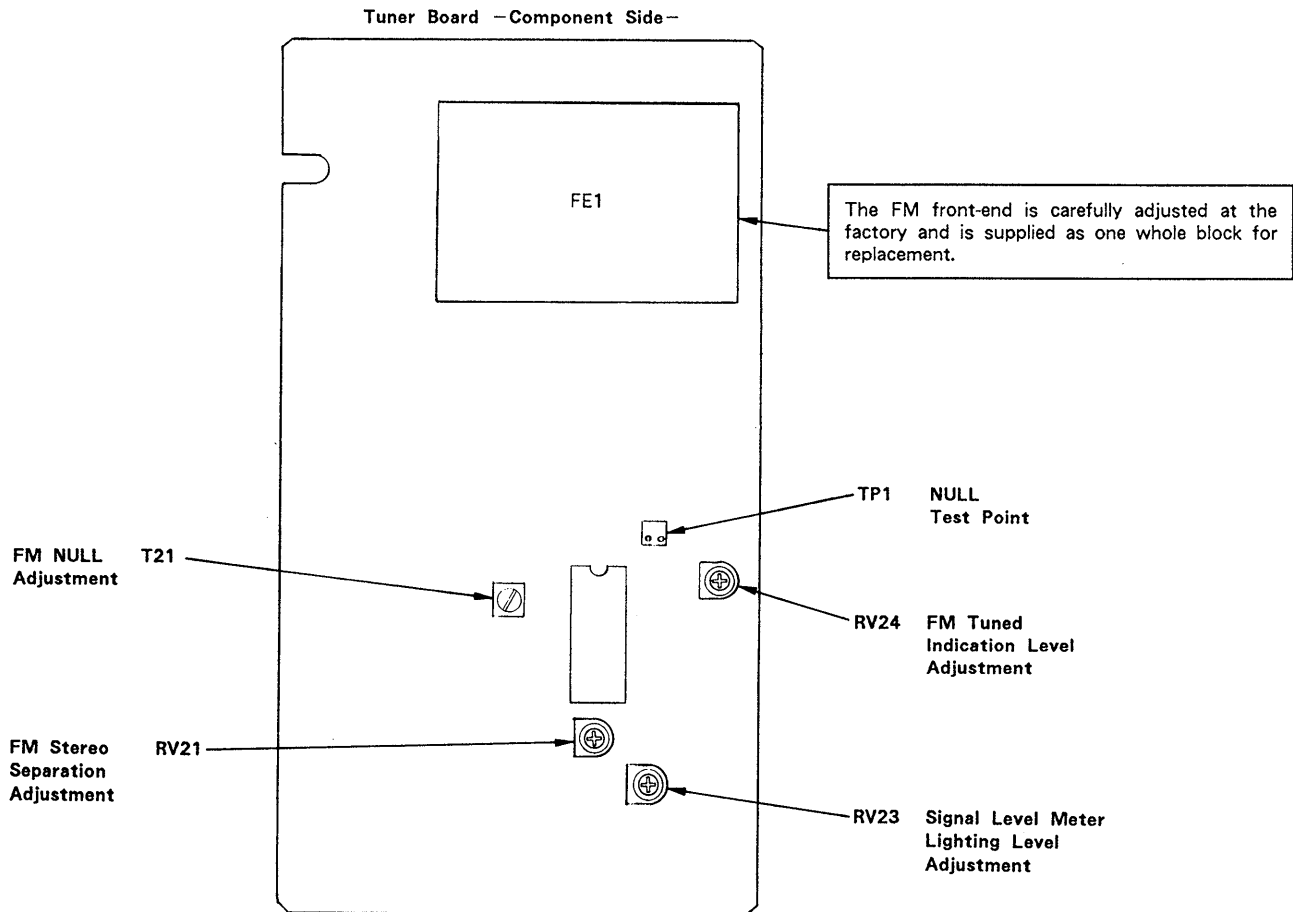

SECTION 3
DIAGRAMS

3-1. PRINTED WIRING BOARDS

Note :
 ○ : parts extracted from the component side.
 ● : parts mounted on the conductor side.

● Semiconductor Lead Layouts ● Semiconductor Location

DTC114ES
2SA1348
2SC2669
2SC3113A

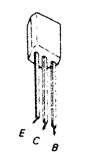

2SA1175HFE
2SC2785HFE

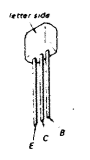

2SK246GR3

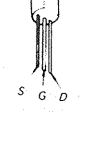

EQA02-17A
EQA02-30B
US1060M
10E2N

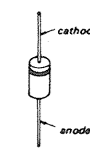

RD5.6ES-B2
1SS120

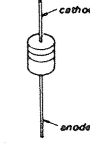

Ref. No.	Location
D21	E-10
D22	E-10
D23	E-10
D24	D-12
D61	D-8 (AEP, UK, WG, IT)
D501	C-17
D502	C-17
D503	D-16
D504	D-16
D505	E-15
D506	D-15
D507	B-14
D701	J-8
D702	I-12
D703	I-13
D705	I-17 (AEP, UK, WG, IT)
D706	I-17 (IT)
D707	I-17 (E2, E3)
D708	I-16
D709	I-16
D710	I-16
D711	I-16
D712	H-15
D713	I-15
D714	J-17
D715	J-18
D716	J-18
D717	I-17
D718	I-17
D719	I-17
D720	I-18
D721	I-6
IC21	D-10
IC81	B-7
IC501	C-16
IC701	I-10
IC702	H-6
Q1	C-7
Q2	C-8
Q3	C-8 (WG, IT, AEP, UK)
Q4	C-8 (WG, IT, AEP, UK)
Q21	C-11
Q22	D-11
Q23	C-8
Q24	C-8
Q26	E-11
Q27	D-11
Q28	D-11
Q61	E-8 (AEP, UK, WG, IT)
Q62	E-8 (AEP, UK, WG, IT)
Q63	E-8 (AEP, UK, WG, IT)
Q64	D-7
Q65	D-8 (AEP, UK, WG, IT)
Q66	D-8 (AEP, UK, WG, IT)
Q81	C-8
Q82	C-8
Q83	B-6
Q84	B-6
Q85	C-6 (AEP, UK, WG, IT)
Q86	C-5 (AEP, UK, WG, IT)

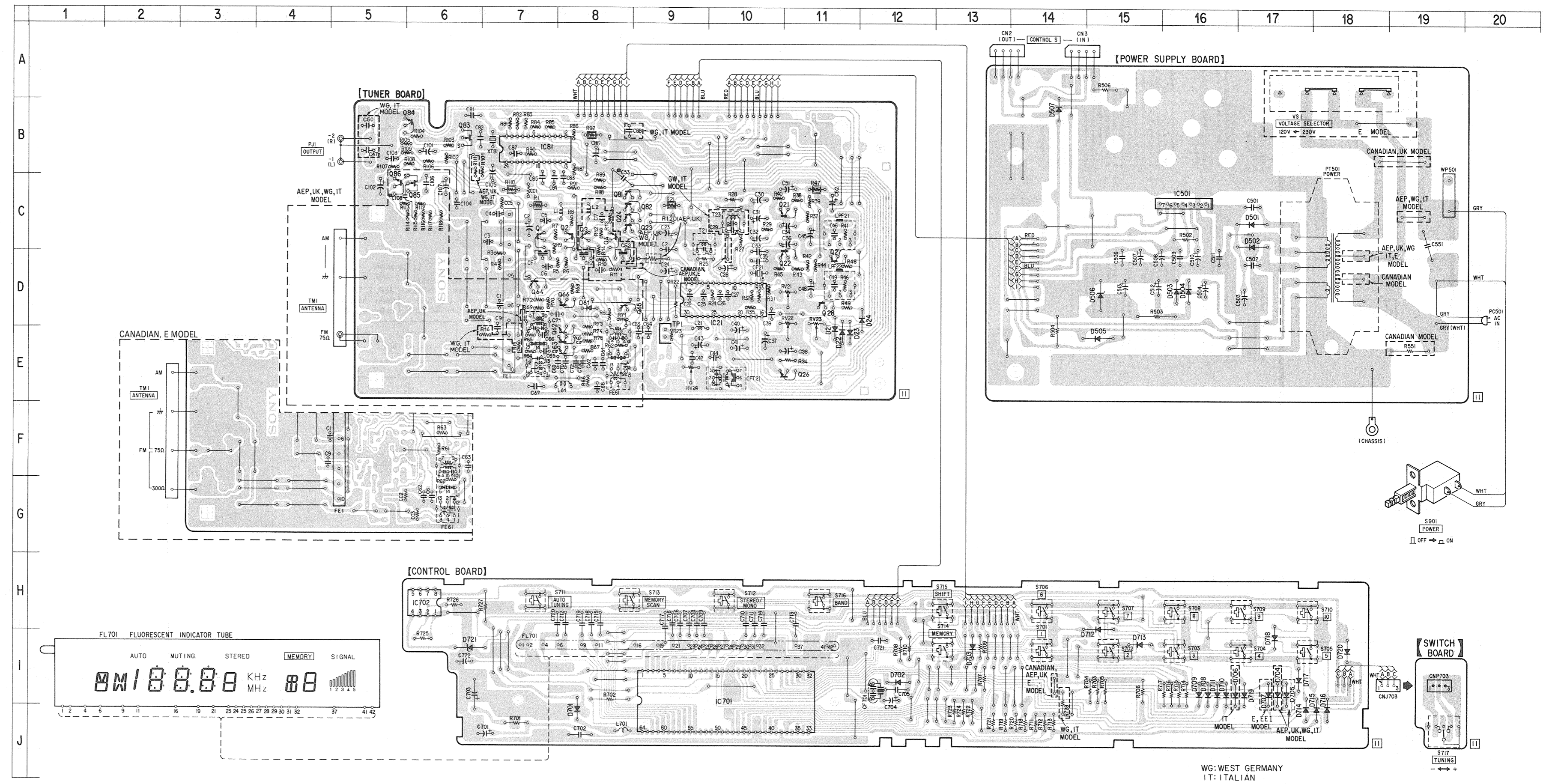

WG: WEST GERMANY
IT: ITALIAN

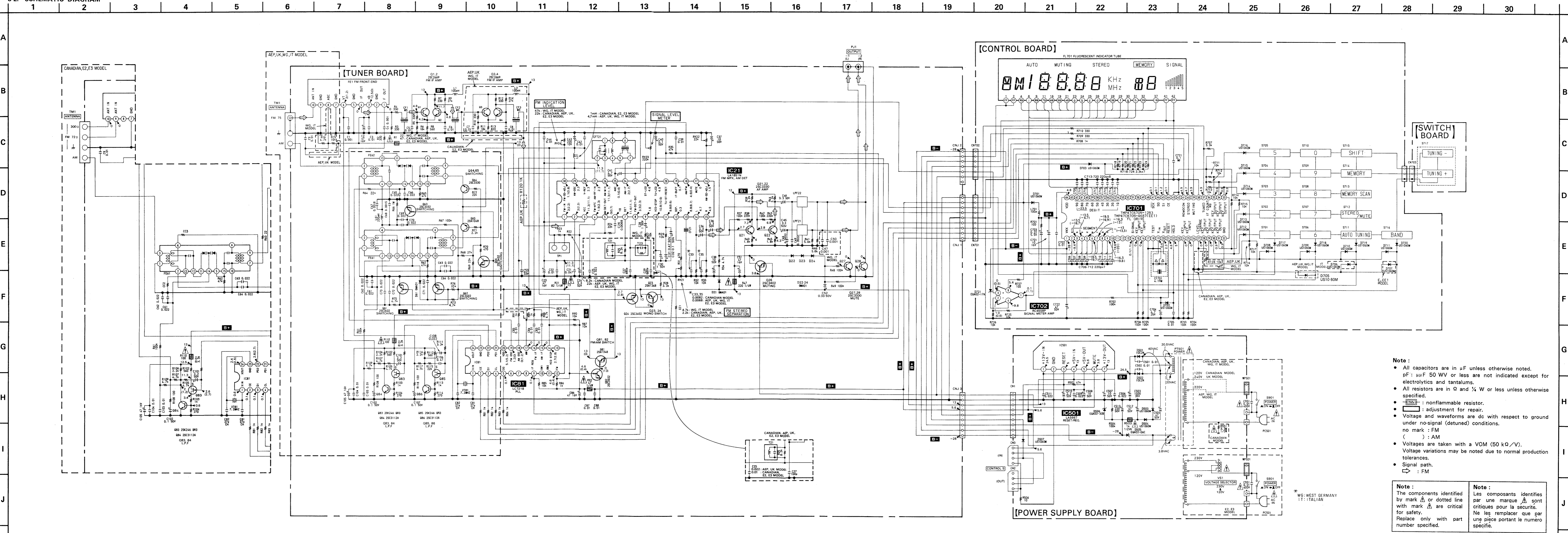

Note:

- All capacitors are in μF unless otherwise noted. pF : μF 50 WV or less are not indicated except for electrolytics and tantalums.
- All resistors are in Ω and $\frac{1}{4}$ W or less unless otherwise specified.
- \square : nonflammable resistor.
- \square : adjustment for repair.
- Voltage and waveforms are dc with respect to ground under no-signal (detuned) conditions. no mark : FM () : AM
- Voltages are taken with a VOM (50 $\text{k}\Omega/\text{V}$). Voltage variations may be noted due to normal production tolerances.
- Signal path. \Rightarrow : FM

Note:
The components identified by mark Δ or dotted line with mark Δ are critical for safety. Replace only with part number specified.

Note:
Les composants identifiés par une marque Δ sont critiques pour la sécurité. Ne les remplacer que par une pièce portant le numéro spécifié.

* WG: WEST GERMANY
IT: ITALIAN

SECTION 4 EXPLODED VIEW

NOTE:

- The mechanical parts with no reference number in the exploded views are not supplied.
- The construction parts of an assembled part are indicated with a collation number in the remark column.
- Items marked "*" are not stocked since they are seldom required for routine service. Some delay should be anticipated when ordering these items.
- //F : Applicable to the model made in France.
- ABBREVIATION
 WG: West German model
 IT: Italian model
 EE1: East European model

- Due to standardization, parts with part number suffix -XX and -X may be different from the parts specified in the components used on the set.
- Color Indication of Appearance Parts
 Example:
 (RED) ... KNOB, BALANCE (WHITE)
 ↑ Cabinet's Color ↑ Parts' Color

The components identified by mark Δ or dotted line with mark Δ are critical for safety. Replace only with part number specified.

Les composants identifiés par une marque Δ sont critiques pour la sécurité. Ne les remplacer que par une pièce portant le numéro spécifié.

AEP, WG, IT Model

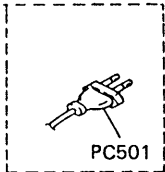

E Model

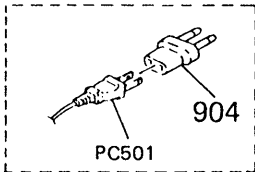

UK Model

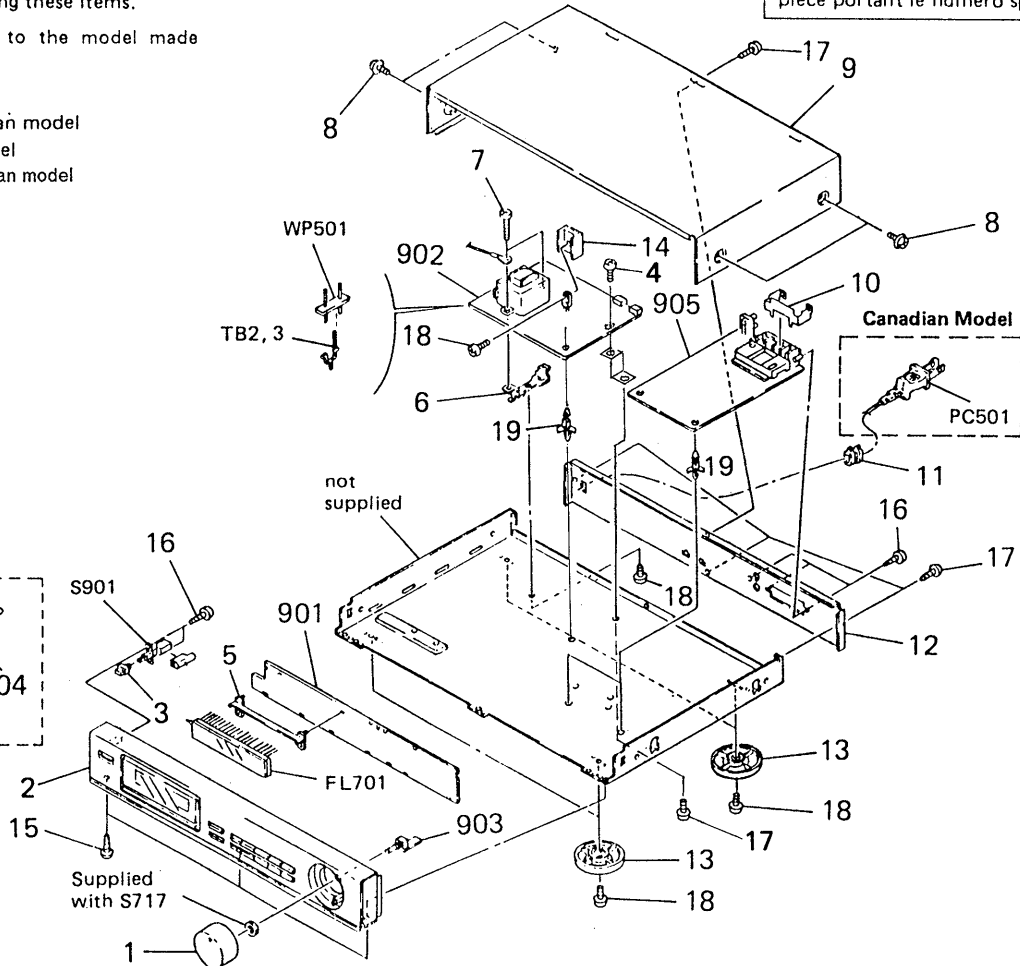
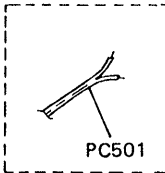

No.	Part No.	Description	Remarks
1	4-923-458-01	KNOB (TUNING)	
2	X-4886-048-1	PANEL (BASE) ASSY	
3	4-917-460-01	KNOB, POWER	
4	4-886-821-11	SCREW M3, CASE (+PTT WH 3X6)	
5	*4-925-125-01	HOLDER, FL TUBE	
6	*4-917-044-01	BRACKET (PT)	
7	7-682-550-04	SCREW +BVTT 3X12 (S)	
8	3-704-366-01	SCREW (CASE) (M3X8)	
9	4-923-457-01	CASE	
10	*4-924-988-11	PLATE (ST), GROUND	
11	*3-703-244-00 *3-703-571-00	(AEP,UK,WG,IT,EE1)...BUSHING (2104), CORD (Canadian,E)...BUSHING (S) (4516), CORD	
12	*4-935-812-01 *4-935-812-21 *4-935-812-31 *4-935-812-41 *4-935-812-71 *4-935-812-81 *4-935-812-51 *4-935-812-61	(WG).....PANEL, BACK (AEP).....PANEL, BACK (UK).....PANEL, BACK (IT).....PANEL, BACK (Canadian).....PANEL, BACK (E).....PANEL, BACK (AEP//F).....PANEL, BACK (IT//F,EE1).....PANEL, BACK	
13	X-4885-938-2 X-4885-950-1	(AEP,UK,E,WG,IT,EE1)...FOOT ASSY (Canadian).....FOOT ASSY	
14	*4-363-146-31	HEAT SINK, V.OUT	
15	3-703-685-21	SCREW (+BV 3X8)	
16	7-685-646-79	SCREW +BVTP 3X8 TYPE2 N-S	
17	7-685-872-09	SCREW +BVTT 3X8 (S)	
18	7-682-548-04	SCREW +BVTT 3X8 (S)	
19	*3-346-265-11	HOLDER, PC BOARD	

No.	Part No.	Description	Remarks
901	*A-4333-525-A *A-4333-527-A *A-4333-528-A *A-4333-530-A *A-4333-740-A *A-4341-268-A	(E).....MOUNTED PCB, CONTROL (IT).....MOUNTED PCB, CONTROL (Canadian)...MOUNTED PCB, CONTROL (AEP,UK).....MOUNTED PCB, CONTROL (WG,IT).....MOUNTED PCB, CONTROL (EE1).....MOUNTED PCB, CONTROL	
902	*1-630-710-11	PC BOARD, POWER	
903	*1-630-711-11	PC BOARD, SWITCH	
904	Δ .1-526-565-00	(E)...AC PLUG ADAPTOR	
905	*A-4303-216-A *A-4303-217-A *A-4303-218-A *A-4303-294-A	(Canadian)...MOUNTED PCB, TUNER (E).....MOUNTED PCB, TUNER (WG,IT).....MOUNTED PCB, TUNER (AEP,UK).....MOUNTED PCB, TUNER	
FL701	1-519-513-11 1-519-614-11	INDICATOR TUBE, FLUORESCENT (EE1)...INDICATOR TUBE, FLUORESCENT	
PC501	Δ .1-551-188-XX Δ .1-555-750-00 Δ .1-558-945-11 Δ .1-556-035-00 Δ .1-574-127-11	(E).....CORD, POWER (AEP,WG,IT)...CORD, POWER (Canadian)...CORD, POWER (POLAR,SPT-1) (UK).....CORD, POWER (AEP,IT//F)...CORD, POWER	
S901	Δ .1-554-920-21	SWITCH, PUSH (AC POWER)(1 KEY)	
TB2	1-535-416-00	TERMINAL	
TB3	1-535-416-00	TERMINAL	
WP501	*1-535-139-00	BASE POST 22MM (10MM PITCH) 2P	

SECTION 5

ELECTRICAL PARTS LIST

NOTE:

- Due to standardization, replacements in the parts list may be different from the parts specified in the diagrams or the components used on the set.
- Items marked "*" are not stocked since they are seldom required for routine service. Some delay should be anticipated when ordering these items.
- If there are two or more same circuits in a set such as a stereophonic machine, only typical circuit parts may be indicated and capacitors and resistors in other same circuits may be omitted.
- **ABBREVIATION**
 WG: West German model
 IT: Italian model
 EE1: East European model

CAPACITORS:
 MF: μ F, PF: μ MF.

RESISTORS
 • All resistors are in ohms.
 • F: nonflammable

COILS
 • MMH: mH, UH: μ H

SEMICONDUCTORS
 In each case, U: μ , for example:
 UA...: μ A..., UPA...: μ PA...,
 UPC...: μ PC, UPD...: μ PD...

- //F : Applicable to the model made in France.

The components identified by mark Δ or dotted line with mark Δ are critical for safety. Replace only with part number specified.

Les composants identifiés par une marque Δ sont critiques pour la sécurité. Ne les remplacer que par une pièce portant le numéro spécifié.

Ref.No.	Part No.	Description			
901	*A-4333-525-A	(E).....MOUNTED PCB, CONTROL			
	*A-4333-527-A	(IT).....MOUNTED PCB, CONTROL			
	*A-4333-528-A	(Canadian)....MOUNTED PCB, CONTROL			
	*A-4333-530-A	(AEP,UK).....MOUNTED PCB, CONTROL			
	*A-4333-740-A	(WG).....MOUNTED PCB, CONTROL			
902	*1-630-710-11	PC BOARD, POWER			
903	*1-630-711-11	PC BOARD, SWITCH			
904	Δ 1-526-565-00	(E)...AC PLUG ADAPTOR			
905	*A-4303-216-A	(Canadian)...MOUNTED PCB, TUNER			
	*A-4303-217-A	(E).....MOUNTED PCB, TUNER			
	*A-4303-218-A	(WG,IT).....MOUNTED PCB, TUNER			
	*A-4303-294-A	(AEP,UK).....MOUNTED PCB, TUNER			
C1	1-162-294-31	CERAMIC CHIP 0.001MF	20%	25V	
C2	1-124-474-11	ELECT 47MF	20%	16V	
C3	1-163-059-00	CERAMIC MELF 0.01MF	20%	16V	
C4	1-162-294-31	CERAMIC CHIP 0.001MF	20%	25V	
C5	1-163-059-00	CERAMIC MELF 0.01MF	20%	16V	
C6	1-163-059-00	CERAMIC MELF 0.01MF	20%	16V	
C7	1-163-059-00	(WG,IT,AEP,UK)...CERAMIC MELF 0.01MF	20%	16V	
C8	1-163-059-00	(WG,IT,AEP,UK)...CERAMIC MELF 0.01MF	20%	16V	
C9	1-163-059-00	CERAMIC MELF 0.01MF	20%	16V	
C21	1-101-006-00	CERAMIC 0.047MF		50V	
C22	1-163-059-00	CERAMIC MELF 0.01MF	20%	16V	
C23	1-124-474-11	ELECT 47MF	20%	16V	
C24	1-123-382-00	ELECT 3.3MF	20%	50V	
C25	1-163-059-00	(Canadian,E) ...CERAMIC MELF 0.01MF	20%	16V	
C25	1-163-063-00	(AEP,UK,WG,IT) ...CERAMIC MELF 0.022MF		25V	
C26	1-162-527-11	CERAMIC CHIP 0.0068MF	20%	12V	
C27	1-162-521-11	(WG,IT)...CERAMIC CHIP 680PF	20%	50V	
C28	1-124-499-11	ELECT 1.0MF	20%	50V	
C29	1-162-521-11	(WG,IT)...CERAMIC CHIP 680PF	20%	50V	
C30	1-124-499-11	ELECT 1.0MF	20%	50V	
C31	1-124-902-00	ELECT 0.47MF	20%	50V	
C32	1-124-463-00	ELECT 0.1MF	20%	50V	
C33	1-130-481-00	(AEP,UK,E,WG,IT) ...PE TEREPHTHALATE 0.0068MF	5%	50V	
C35	1-130-482-00	(Canadian) ...PE TEREPHTHALATE 0.0082MF	5%	50V	
C34	1-123-382-00	ELECT 3.3MF	20%	50V	
C35	1-130-481-00	(AEP,UK,E,WG,IT) ...PE TEREPHTHALATE 0.0068MF	5%	50V	
C35	1-130-482-00	(Canadian) ...PE TEREPHTHALATE 0.0082MF	5%	50V	
C36	1-123-382-00	ELECT 3.3MF	20%	50V	
C37	1-123-875-11	ELECT 10MF	20%	50V	
C38	1-123-875-11	ELECT 10MF	20%	50V	

Ref.No.	Part No.	Description			
C39	1-163-059-00	CERAMIC MELF 0.01MF	20%	16V	
C40	1-124-463-00	ELECT 0.1MF	20%	50V	
C41	1-124-927-11	ELECT 4.7MF	20%	16V	
C42	1-163-059-00	CERAMIC MELF 0.01MF	20%	16V	
C43	1-126-176-11	ELECT 220MF	20%	10V	
C44	1-163-059-00	CERAMIC MELF 0.01MF	20%	16V	
C45	1-123-382-00	ELECT 3.3MF	20%	50V	
C46	1-162-524-11	CERAMIC CHIP 0.0022MF	20%	25V	
C47	1-162-294-31	(WG,IT)...CERAMIC CHIP 0.001MF	20%	25V	
C48	1-123-382-00	ELECT 3.3MF	20%	50V	
C49	1-162-524-11	CERAMIC CHIP 0.0022MF	20%	25V	
C50	1-162-294-31	(WG,IT)...CERAMIC CHIP 0.001MF	20%	25V	
C51	1-124-474-11	ELECT 47MF	20%	16V	
C52	1-124-252-00	ELECT 0.33MF	20%	50V	
C53	1-162-211-11	CERAMIC 33PF	5%	50V	
C61	1-163-063-00	CERAMIC MELF 0.022MF		25V	
C62	1-163-063-00	CERAMIC MELF 0.022MF		25V	
C63	1-163-063-00	CERAMIC MELF 0.022MF		25V	
C64	1-163-063-00	CERAMIC MELF 0.022MF		25V	
C65	1-163-063-00	(AEP,UK,WG,IT) ...CERAMIC MELF 0.022MF		25V	
C66	1-163-063-00	(AEP,UK,WG,IT) ...CERAMIC MELF 0.022MF		25V	
C67	1-102-120-00	(AEP,UK,WG,IT) ...CERAMIC 0.0018MF	10%	50V	
C68	1-162-523-11	(AEP,UK,WG,IT) ...CERAMIC CHIP 0.0015MF	20%	25V	
C69	1-163-063-00	(AEP,UK,WG,IT) ...CERAMIC MELF 0.022MF		25V	
C70	1-163-063-00	(AEP,UK,WG,IT) ...CERAMIC MELF 0.022MF		25V	
C71	1-163-063-00	(AEP,UK,WG,IT) ...CERAMIC MELF 0.022MF		25V	
C72	1-163-063-00	(AEP,UK,WG,IT) ...CERAMIC MELF 0.022MF		25V	
C73	1-163-063-00	(AEP,UK,WG,IT) ...CERAMIC MELF 0.022MF		25V	
C81	1-102-961-00	CERAMIC 27PF	5%	50V	
C82	1-102-961-00	CERAMIC 27PF	5%	50V	
C83	1-163-059-00	CERAMIC MELF 0.01MF	20%	16V	
C84	1-163-059-00	CERAMIC MELF 0.01MF	20%	16V	
C85	1-163-059-00	CERAMIC MELF 0.01MF	20%	16V	
C86	1-124-474-11	ELECT 47MF	20%	16V	
C87	1-163-059-00	CERAMIC MELF 0.01MF	20%	16V	
C88	1-163-059-00	CERAMIC MELF 0.01MF	20%	16V	
C101	1-124-925-11	ELECT 2.2MF	20%	50V	
C102	1-124-463-00	ELECT 0.1MF	20%	50V	
C103	1-163-059-00	CERAMIC MELF 0.01MF	20%	16V	
C104	1-163-059-00	CERAMIC MELF 0.01MF	20%	16V	

Ref.No.	Part No.	Description			
C105	1-124-474-11	ELECT	47MF	20%	50V
C106	1-136-173-00	(AEP,UK,WG,IT)... METALIZED FILM	0.47MF	5%	50V
C107	1-124-463-00	(AEP,UK,WG,IT)...ELECT	0.1MF	20%	50V
C108	1-101-005-00	CERAMIC	0.022MF		50V
C501	1-101-004-00	CERAMIC	0.01MF		50V
C502	1-101-004-00	CERAMIC	0.01MF		50V
C503	1-126-105-11	ELECT	1000MF	20%	35V
C504	1-124-910-11	ELECT	47MF	20%	50V
C506	1-101-005-00	CERAMIC	0.022MF		50V
C507	1-123-875-11	ELECT	10MF	20%	50V
C508	1-123-875-11	ELECT	10MF	20%	50V
C509	1-101-005-00	CERAMIC	0.022MF		50V
C510	1-124-925-11	ELECT	2.2MF	20%	50V
C511	1-101-005-00	CERAMIC	0.022MF		50V
C512	1-124-910-11	ELECT	47MF	20%	50V
C513	1-124-911-11	ELECT	220MF	20%	50V
C551	1-161-744-00	CERAMIC	0.01MF		400V
C701	1-126-157-11	ELECT	10MF	20%	16V
C702	1-161-379-00	CERAMIC	0.01MF	30%	16V
C703	1-125-486-11	DOUBLELAYERS	0.22F		5.5V
C704	1-126-094-11	ELECT	4.7MF	20%	25V
C705	1-161-379-00	CERAMIC	0.01MF	30%	16V
C706	1-162-286-31	CERAMIC	220PF	10%	50V
C707	1-162-286-31	CERAMIC	220PF	10%	50V
C708	1-162-286-31	CERAMIC	220PF	10%	50V
C709	1-162-286-31	CERAMIC	220PF	10%	50V
C710	1-162-286-31	CERAMIC	220PF	10%	50V
C711	1-162-286-31	CERAMIC	220PF	10%	50V
C712	1-162-286-31	CERAMIC	220PF	10%	50V
C713	1-162-286-31	CERAMIC	220PF	10%	50V
C714	1-162-286-31	CERAMIC	220PF	10%	50V
C715	1-162-286-31	CERAMIC	220PF	10%	50V
C717	1-162-286-31	CERAMIC	220PF	10%	50V
C718	1-162-286-31	CERAMIC	220PF	10%	50V
C719	1-162-286-31	CERAMIC	220PF	10%	50V
C720	1-162-286-31	CERAMIC	220PF	10%	50V
C721	1-136-165-00	FILM	0.1MF	5%	50V
C722	1-124-910-11	ELECT	47MF	20%	50V
CC1	1-249-366-11	CARBON MELF	0	5%	1/5W
CC2	1-249-366-11	(Canadian,E) ...CARBON MELF	0	5%	1/5W
CC3	1-249-366-11	(Canadian,E)			
CC5	1-249-997-11	(AEP,UK)...CARBON MELF	0	5%	1/8W
CF1	1-567-389-11	FILTER, CERAMIC			
CF2	1-567-389-11	FILTER, CERAMIC			
CF3	1-567-389-11	(WG,IT,AEP,UK)...FILTER, CERAMIC			
CF21	1-577-075-11	OSCILLATOR, CERAMIC			
CF701	1-577-359-21	VIBRATOR, CERAMIC			
CFT21	1-404-853-11	TRANSFORMER,IF(CERAMIC FILTER)			
CN1	*1-568-284-11	SOCKET, CONNECTOR 9P			
CN2	1-564-980-11	PIN, CONNECTOR 4P			
CN3	1-564-980-11	PIN, CONNECTOR 4P			
CN702	*1-568-281-11	SOCKET, CONNECTOR 6P			
CN703	*1-564-337-00	PIN, CONNECTOR 3P			

Ref.No.	Part No.	Description
CNJ1	*1-506-503-11	PIN, CONNECTOR 9P
CNJ2	*1-568-273-11	SOCKET, CONNECTOR 7P
CNJ3	*1-568-275-11	SOCKET, CONNECTOR 9P
D21	8-719-912-20	(AEP,IT//F)...DIODE 1SS120
D21	8-719-000-26	DIODE US1060M
D22	8-719-912-20	(AEP,IT//F)...DIODE 1SS120
D22	8-719-000-26	DIODE US1060M
D23	8-719-912-20	(AEP,IT//F)...DIODE 1SS120
D23	8-719-000-26	DIODE US1060M
D24	8-719-912-20	(AEP,IT//F)...DIODE 1SS120
D24	8-719-000-26	DIODE US1060M
D61	8-719-912-20	(AEP,IT//F).....DIODE 1SS120
D61	8-719-000-26	(AEP,UK,WG,IT)...DIODE US1060M
D501	8-719-200-77	DIODE 10E2N
D501	8-719-200-82	(IT//F)...DIODE 11ES2
D502	8-719-200-77	DIODE 10E2N
D502	8-719-200-82	(IT//F)...DIODE 11ES2
D503	8-719-000-26	DIODE US1060M
D503	8-719-912-20	(AEP,IT//F)...DIODE 1SS120
D504	8-719-000-26	DIODE US1060M
D504	8-719-912-20	(AEP,IT//F)...DIODE 1SS120
D505	8-719-912-81	DIODE EQA02-06
D506	8-719-904-93	DIODE EQA02-30B
D507	8-719-000-26	DIODE US1060M
D507	8-719-912-20	(AEP,IT//F)...DIODE 1SS120
D701	8-719-000-26	DIODE US1060M
D701	8-719-912-20	(AEP,IT//F)...DIODE 1SS120
D702	8-719-000-26	DIODE US1060M
D702	8-719-912-20	(AEP,IT//F)...DIODE 1SS120
D703	8-719-000-26	DIODE US1060M
D703	8-719-912-20	(AEP,IT//F)...DIODE 1SS120
D705	8-719-000-26	(AEP,UK,WG,IT)...DIODE US1060M
D705	8-719-912-20	(AEP,IT//F)...DIODE 1SS120
D706	8-719-000-26	(IT).....DIODE US1060M
D706	8-719-912-20	(AEP,IT//F)...DIODE 1SS120
D707	8-719-000-26	(E,EE1)...DIODE US1060M
D708	8-719-000-26	DIODE US1060M
D708	8-719-912-20	(AEP,IT//F)...DIODE 1SS120
D709	8-719-000-26	DIODE US1060M
D709	8-719-912-20	(AEP,IT//F)...DIODE 1SS120
D710	8-719-000-26	DIODE US1060M
D710	8-719-912-20	(AEP,IT//F)...DIODE 1SS120
D711	8-719-000-26	DIODE US1060M
D711	8-719-912-20	(AEP,IT//F)...DIODE 1SS120
D712	8-719-000-26	DIODE US1060M
D712	8-719-912-20	(AEP,IT//F)...DIODE 1SS120
D713	8-719-000-26	DIODE US1060M
D713	8-719-912-20	(AEP,IT//F)...DIODE 1SS120
D714	8-719-000-26	DIODE US1060M
D714	8-719-912-20	(AEP,IT//F)...DIODE 1SS120
D715	8-719-000-26	DIODE US1060M
D715	8-719-912-20	(AEP,IT//F)...DIODE 1SS120

Ref.No.	Part No.	Description
D716	8-719-000-26	DIODE US1060M
D716	8-719-912-20	(AEP,IT//F)...DIODE 1SS120
D717	8-719-000-26	DIODE US1060M
D717	8-719-912-20	(AEP,IT//F)...DIODE 1SS120
D718	8-719-000-26	DIODE US1060M
D718	8-719-912-20	(AEP,IT//F)...DIODE 1SS120
D719	8-719-000-27	DIODE US1060M
D719	8-719-912-20	(AEP,IT//F)...DIODE 1SS120
D720	8-719-000-27	DIODE US1060M
D720	8-719-912-20	(AEP,IT//F)...DIODE 1SS120
D721	8-719-913-28	DIODE EQA02-17A
FE1	1-463-857-11	(WG,IT).....FRONT END (FM)
FE1	1-463-862-21	(Canadian,AEP,UK,E)...FRONT END, FM
FE1	1-465-560-11	(EE1).....FRONT END, FM
FE61	1-236-462-11	ENCAPSULATED COMPONENT
FE62	1-236-463-11	(AEP,UK,WG,IT)...ENCAPSULATED COMPONENT
FL701	1-519-513-11	INDICATOR TUBE, FLUORESCENT
FL701	1-519-614-11	(EE1)...INDICATOR TUBE, FLUORESCENT
IC21	8-759-821-45	IC LA1851N
IC81	8-759-820-91	IC LC7218
IC501	8-759-820-09	IC LA5667
IC701	8-759-242-91	(EE1)...IC TMP47C870N-4687
IC701	8-759-234-35	IC TMP47C670N-1283
IC702	8-759-945-58	IC RC4558P
L1	1-410-645-31	MICRO INDUCTOR 100UH
L2	1-410-645-31	(WG,IT,AEP,UK)...MICRO INDUCTOR 100UH
L21	1-407-500-00	(AEP,UK,WG,IT)...MICRO INDUCTOR 4.7UH
L21	1-410-171-11	(Canadian,E)...MICRO INDUCTOR 1.0MMH
L61	1-410-525-11	(AEP,UK,WG,IT)...MICRO INDUCTOR 220UH
L701	1-410-521-11	INDUCTOR 100UH
LPF21	1-235-164-00	FILTER, LOW PASS
LPF22	1-235-164-00	FILTER, LOW PASS
PT501	1-449-400-11	(AEP,UK,WG,IT,EE1)...TRANSFORMER, POWER
PT501	1-449-401-11	(E).....TRANSFORMER, POWER
PT501	1-449-402-11	(Canadian).....TRANSFORMER, POWER
PC501	1-551-188-XX	(E).....CORD, POWER
PC501	1-555-750-00	(AEP,WG,IT)...CORD, POWER
PC501	1-558-945-11	(Canadian)...CORD, POWER (POLAR,SPT-1)
PC501	1-556-035-00	(UK).....CORD, POWER
PC501	1-574-127-11	(AEP,IT//F)...CORD, POWER
PJ1	1-565-352-11	JACK, PIN 2P
Q1	8-729-266-93	TRANSISTOR 2SC2669
Q2	8-729-266-93	TRANSISTOR 2SC2669
Q3	8-729-266-93	(WG,IT,AEP,UK)...TRANSISTOR 2SC2669
Q4	8-729-266-93	(WG,IT,AEP,UK)...TRANSISTOR 2SC2669
Q21	8-729-119-78	TRANSISTOR 2SC2785HFE
Q22	8-729-119-78	TRANSISTOR 2SC2785HFE
Q23	8-729-806-10	TRANSISTOR 2SA1348
Q24	8-729-900-80	TRANSISTOR DTC114ES
Q26	8-729-900-80	TRANSISTOR DTC114ES
Q27	8-729-119-78	TRANSISTOR 2SC2785HFE
Q28	8-729-119-78	TRANSISTOR 2SC2785HFE
Q61	8-729-900-80	(AEP,UK,WG,IT)...TRANSISTOR DTC114ES
Q62	8-729-900-80	(AEP,UK,WG,IT)...TRANSISTOR DTC114ES
Q63	8-729-900-80	(AEP,UK,WG,IT)...TRANSISTOR DTC114ES
Q64	8-729-119-78	TRANSISTOR 2SC2785HFE

Ref.No.	Part No.	Description
Q65	8-729-820-10	TRANSISTOR 2SA1317
Q65	8-729-119-76	(AEP,IT//F)...TRANSISTOR 2SA1175HFE
Q66	8-729-900-80	(AEP,UK,WG,IT)...TRANSISTOR DTC114ES
Q81	8-729-806-10	TRANSISTOR 2SA1348
Q82	8-729-900-80	TRANSISTOR DTC114ES
Q83	8-729-202-67	TRANSISTOR 2SK246GR3
Q84	8-729-203-53	TRANSISTOR 2SC3113A
Q85	8-729-202-67	(AEP,UK,WG,IT)...TRANSISTOR 2SK246GR3
Q86	8-729-203-53	(AEP,UK,WG,IT)...TRANSISTOR 2SC3113A
R1	1-249-401-11	(Canadian,AEP,UK,E) ...CARBON 47 5% 1/4W F
R1	1-249-397-11	(WG,IT)...CARBON 22 5% 1/4W F
R3	1-249-329-11	CARBON MELF 330 5% 1/8W
R4	1-249-329-11	CARBON MELF 330 5% 1/8W
R5	1-249-329-11	CARBON MELF 330 5% 1/8W
R6	1-249-350-11	CARBON MELF 18K 5% 1/8W
R7	1-249-329-11	CARBON MELF 330 5% 1/8W
R8	1-249-332-11	CARBON MELF 560 5% 1/8W
R9	1-249-352-11	CARBON MELF 27K 5% 1/8W
R10	1-249-329-11	(WG,IT,AEP,UK)...CARBON MELF 330 5% 1/8W
R11	1-249-350-11	(WG,IT,AEP,UK)...CARBON MELF 18K 5% 1/8W
R12	1-249-329-11	(WG,IT,AEP,UK)...CARBON MELF 330 5% 1/8W
R13	1-249-334-11	(WG,IT,AEP,UK)...CARBON MELF 820 5% 1/8W
R14	1-249-352-11	(WG,IT,AEP,UK)...CARBON MELF 27K 5% 1/8W
R15	1-249-347-11	(WG,IT)...CARBON MELF 10K 5% 1/8W
R16	1-249-343-11	(WG,IT)...CARBON MELF 4.7K 5% 1/8W
R21	1-249-404-00	CARBON (SMALL) 82 5% 1/4W F
R22	1-249-428-11	(Canadian)...CARBON 8.2K 5% 1/4W
R22	1-249-433-11	(AEP,UK,E,WG,IT) ...CARBON (SMALL) 22K 5% 1/4W
R23	1-249-335-11	CARBON MELF 1K 5% 1/8W
R24	1-249-353-11	CARBON MELF 33K 5% 1/8W
R25	1-249-428-11	CARBON (SMALL) 8.2K 5% 1/4W
R27	1-249-350-11	CARBON MELF 18K 5% 1/8W
R28	1-249-423-11	CARBON (SMALL) 3.3K 5% 1/4W
R29	1-249-347-11	CARBON MELF 10K 5% 1/8W
R31	1-249-331-11	CARBON MELF 470 5% 1/8W
R32	1-249-347-11	CARBON MELF 10K 5% 1/8W
R33	1-249-347-11	CARBON MELF 10K 5% 1/8W
R34	1-249-425-11	CARBON (SMALL) 4.7K 5% 1/4W
R35	1-249-355-11	CARBON MELF 47K 5% 1/8W
R37	1-249-359-11	CARBON MELF 100K 5% 1/8W
R38	1-249-363-11	CARBON MELF 220K 5% 1/8W
R39	1-249-339-11	CARBON MELF 2.2K 5% 1/8W
R40	1-249-338-11	CARBON MELF 1.8K 5% 1/8W
R41	1-249-344-11	CARBON MELF 5.6K 5% 1/8W
R42	1-249-359-11	CARBON MELF 100K 5% 1/8W
R43	1-249-363-11	CARBON MELF 220K 5% 1/8W
R44	1-249-339-11	CARBON MELF 2.2K 5% 1/8W
R45	1-249-338-11	CARBON MELF 1.8K 5% 1/8W
R46	1-249-344-11	CARBON MELF 5.6K 5% 1/8W
R47	1-249-409-11	CARBON (SMALL) 220 5% 1/4W F
R48	1-249-359-11	CARBON MELF 100K 5% 1/8W
R49	1-249-359-11	CARBON MELF 100K 5% 1/8W
P61	1-249-359-11	CARBON MELF 100K 5% 1/8W
R62	1-249-355-11	CARBON MELF 47K 5% 1/8W

<p>Note: The components identified by mark Δ or dotted line with mark Δ are critical for safety. Replace only with part number specified.</p>	<p>Note: Les composants identifiés par une marque Δ sont critiques pour la sécurité. Ne les remplacer que par une pièce portant le numéro spécifié.</p>
--	--

Ref.No.	Part No.	Description				
R63	1-249-315-11	(Canadian,E) ...CARBON MELF	22	5%	1/8W	
R64	1-249-351-11	(AEP,UK,WG,IT) ...CARBON MELF	22K	5%	1/8W	
R65	1-249-355-11	(AEP,UK,WG,IT) ...CARBON MELF	47K	5%	1/8W	
R66	1-215-493-00	(AEP,UK,WG,IT) ...CARBON MELF	1M	5%	1/5W	
R67	1-249-359-11	(AEP,UK,WG,IT) ...CARBON MELF	100K	5%	1/8W	
R68	1-249-352-11	(AEP,UK,WG,IT) ...CARBON MELF	27K	5%	1/8W	
R69	1-249-351-11	(AEP,UK,WG,IT) ...CARBON MELF	22K	5%	1/8W	
R70	1-249-331-11	(AEP,UK,WG,IT) ...CARBON MELF	470	5%	1/8W	
R71	1-249-339-11	(AEP,UK,WG,IT) ...CARBON MELF	2.2K	5%	1/8W	
R72	1-249-351-11	(AEP,UK,WG,IT) ...CARBON MELF	22K	5%	1/8W	
R73	1-249-343-11	(AEP,UK,WG,IT) ...CARBON MELF	4.7K	5%	1/8W	
R74	1-249-347-11	(AEP,UK,WG,IT) ...CARBON MELF	10K	5%	1/8W	
R75	1-249-343-11	(AEP,UK,WG,IT) ...CARBON MELF	4.7K	5%	1/8W	
R81	1-249-335-11	CARBON MELF	1K	5%	1/8W	
R82	1-249-335-11	CARBON MELF	1K	5%	1/8W	
R83	1-249-335-11	CARBON MELF	1K	5%	1/8W	
R84	1-249-335-11	CARBON MELF	1K	5%	1/8W	
R85	1-249-347-11	CARBON MELF	10K	5%	1/8W	
R86	1-249-335-11	CARBON MELF	1K	5%	1/8W	
R87	1-249-347-11	CARBON MELF	10K	5%	1/8W	
R88	1-249-343-11	CARBON MELF	4.7K	5%	1/8W	
R89	1-249-335-11	CARBON MELF	1K	5%	1/8W	
R90	1-249-347-11	CARBON MELF	10K	5%	1/8W	
R91	1-249-335-11	CARBON MELF	1K	5%	1/8W	
R92	△ 1-249-401-11	CARBON (SMALL)	47	5%	1/4W	F
R101	1-249-341-11	CARBON MELF	3.3K	5%	1/8W	
R102	1-249-332-11	CARBON MELF	560	5%	1/8W	
R103	1-249-335-11	CARBON MELF	1K	5%	1/8W	
R104	1-249-328-11	CARBON MELF	270	5%	1/8W	
R105	1-249-343-11	CARBON MELF	4.7K	5%	1/8W	
R106	1-249-339-11	CARBON MELF	2.2K	5%	1/8W	
R107	1-249-343-11	CARBON MELF	4.7K	5%	1/8W	
R108	1-249-323-11	CARBON MELF	100	5%	1/8W	
R109	1-249-343-11	CARBON MELF	4.7K	5%	1/8W	
R110	△ 1-249-405-11	CARBON (SMALL)	100	5%	1/4W	F
R111	1-249-341-11	(AEP,UK,WG,IT) ...CARBON MELF	3.3K	5%	1/8W	
R112	1-249-332-11	(AEP,UK,WG,IT) ...CARBON MELF	560	5%	1/8W	
R113	1-249-335-11	(AEP,UK,WG,IT) ...CARBON MELF	1K	5%	1/8W	
R114	1-249-328-11	(AEP,UK,WG,IT) ...CARBON MELF	270	5%	1/8W	
R115	1-249-351-11	(AEP,UK,WG,IT) ...CARBON MELF	22K	5%	1/8W	
R116	1-249-339-11	(AEP,UK,WG,IT) ...CARBON MELF	2.2K	5%	1/8W	

Ref.No.	Part No.	Description				
R117	1-249-343-11	(AEP,UK,WG,IT) CARBON MELF	4.7K	5%	1/8W	
R118	1-249-323-11	(AEP,UK,WG,IT) CARBON MELF	100	5%	1/8W	
R120	1-249-335-11	CARBON MELF	1K	5%	1/8W	
R502	1-249-437-11	CARBON	47K	5%	1/4W	
R503	△ 1-247-752-11	CARBON	1K	5%	1/2W	F
R504	1-249-441-11	CARBON	100K	5%	1/4W	
R506	1-249-393-11	CARBON	10	5%	1/4W	
R551	1-202-725-00	(Canadian)...SOLID	100	5%	1/4W	
R701	1-249-405-11	CARBON	100	5%	1/4W	
R702	1-249-441-11	CARBON	100K	5%	1/4W	
R703	1-249-441-11	CARBON	100K	5%	1/4W	
R704	1-249-441-11	CARBON	100K	5%	1/4W	
R705	1-249-441-11	CARBON	100K	5%	1/4W	
R706	1-249-441-11	CARBON	100K	5%	1/4W	
R707	1-249-423-11	CARBON	3.3K	5%	1/4W	
R708	1-249-417-11	CARBON	1K	5%	1/4W	
R709	1-249-411-11	CARBON	330	5%	1/4W	
R710	1-249-411-11	CARBON	330	5%	1/4W	
R711	1-249-429-11	CARBON	10K	5%	1/4W	
R712	1-249-429-11	CARBON	10K	5%	1/4W	
R713	1-249-429-11	CARBON	10K	5%	1/4W	
R714	1-249-429-11	CARBON	10K	5%	1/4W	
R715	1-249-429-11	CARBON	10K	5%	1/4W	
R716	1-249-429-11	CARBON	10K	5%	1/4W	
R717	1-249-429-11	CARBON	10K	5%	1/4W	
R718	1-249-423-11	CARBON	3.3K	5%	1/4W	
R719	1-249-423-11	CARBON	3.3K	5%	1/4W	
R720	1-249-423-11	CARBON	3.3K	5%	1/4W	
R721	1-249-423-11	CARBON	3.3K	5%	1/4W	
R722	1-249-423-11	CARBON	3.3K	5%	1/4W	
R723	1-249-423-11	CARBON	3.3K	5%	1/4W	
R724	1-249-423-11	CARBON	3.3K	5%	1/4W	
R725	1-249-429-11	CARBON	10K	5%	1/4W	
R726	1-249-429-11	CARBON	10K	5%	1/4W	
R727	1-249-405-11	CARBON	100	5%	1/4W	
R728	1-249-429-11	(WG, IT, AEP, UK)...CARBON	10K	5%	1/4W	
RV21	1-238-013-11	(Canadian,E,AEP,UK) ...RES, ADJ, CARBON 2.2K				
RV21	1-238-015-11	(WG,IT).....RES, ADJ, CARBON 4.7K				
RV22	1-238-017-11	RES, ADJ, CARBON 22K				
RV23	1-238-021-11	RES, ADJ, CARBON 220K				
S701	1-554-303-21	SWITCH, KEY BOARD (1)				
S702	1-554-303-21	SWITCH, KEY BOARD (2)				
S703	1-554-303-21	SWITCH, KEY BOARD (3)				
S704	1-554-303-21	SWITCH, KEY BOARD (4)				
S705	1-554-303-21	SWITCH, KEY BOARD (5)				
S706	1-554-303-21	SWITCH, KEY BOARD (6)				
S707	1-554-303-21	SWITCH, KEY BOARD (7)				
S708	1-554-303-21	SWITCH, KEY BOARD (8)				
S709	1-554-303-21	SWITCH, KEY BOARD (9)				
S710	1-554-303-21	SWITCH, KEY BOARD (0)				
S711	1-554-303-21	SWITCH, KEY BOARD (AUTO TUNING)				
S712	1-554-303-21	SWITCH, KEY BOARD (STEREO/MUTING)				
S713	1-554-303-21	SWITCH, KEY BOARD (MEMORY SCAN)				
S714	1-554-303-21	SWITCH, KEY BOARD (MEMORY)				
S715	1-554-303-21	SWITCH, KEY BOARD (SHIFT)				

Note:
The components identified by mark **△** or dotted line with mark **△** are critical for safety. Replace only with part number specified.

Note:
Les composants identifiés par une marque **△** sont critiques pour la sécurité. Ne les remplacer que par une pièce portant le numéro spécifié.

Ref.No.	Part No.	Description
S716	1-554-303-21	SWITCH, KEY BOARD (BAND)
S717	1-571-327-21	SWITCH, ROTARY (TUNING)
S901	△.1-554-920-21	SWITCH, PUSH (AC POWER)(1 KEY)
T21	1-404-807-11	TRANSFORMER, DISCRIMINATOR
T23	1-236-465-11	(WG,IT)...ENCAPSULATED COMPONENT
TB2	1-535-416-00	TERMINAL
TB3	1-535-416-00	TERMINAL
TM1	*1-536-708-00	(Canadian,E)...TERMINAL BOARD, PUSH 4P
TM1	*1-537-138-21	(AEP,UK).....TERMINAL BOARD (ANT)
TM1	*1-537-138-31	(WG,IT).....TERMINAL BOARD (ANT)
TPI	*1-560-060-00	PIN, CONNECTOR 2P (NULL)
VSI	△.1-571-722-11	(E).....SWITCH, VOLTAGE SELECTION
WP501	*1-535-139-00	BASE POST 22MM (10MM PITCH) 2P
XT81	1-577-126-11	VIBRATOR, CRYSTAL

ACCESSORY & PACKING MATERIAL

1-501-369-11	(AEP, UK, IT, EE1)..ANTENNA
1-501-351-21	(Canadian,E)...ANTENNA, FEEDER
1-501-374-11	ANTENNA, LOOP
△.1-526-565-00	(E)...AC PLUG ADAPTOR
1-558-233-11	CORD (WITH CONNECTOR)(SIRCS)4P
1-559-533-11	CORD, CONNECTION
3-701-630-00	BAG, POLYETHYLENE
3-751-339-11	(Canadian,UK,E,IT)...MANUAL, INSTRUCTION (ENGLISH,FRENCH,SPANISH,ITALIAN)
3-751-339-41	(AEP,WG).....MANUAL, INSTRUCTION (GERMAN,DUTCH,SWEDISH,PORTUGUESE)
3-751-339-51	(EE1)..MANUAL, INSTRUCTION (ENGLISH,GERMAN,PORTUGUESE,RUSSIAN)
*3-704-343-01	SHEET (STANDARD), PROTECTION
*4-917-074-01	CUSHION
*4-917-056-21	INDIVIDUAL CARTON

Note:
The components identified by mark △ or dotted line with mark △ are critical for safety. Replace only with part number specified.

Note:
Les composants identifiés par une marque △ sont critiques pour la sécurité. Ne les remplacer que par une pièce portant le numéro spécifié.