

# ICF-2001D/2010

## SERVICE MANUAL

ICF-2001D:  
AEP Model  
UK Model  
E Model  
AUS Model

ICF-2010:  
US Model  
Canadian Model



ICF-2010 shown.

### SPECIFICATIONS

|                    |  |
|--------------------|--|
| Circuit system     | FM: Superheterodyne<br>AIR/AM: Dual conversion superheterodyne   |
| Frequency range    | AIR: 116 – 136 MHz (Except Middle Easts, Saudi Arabia, UK, Denmark, Finland, Norway, Federal Republic of Germany)<br>FM: 76 – 108 MHz ((US, Canadian, E (Except Middle Easts, Saudi Arabia), AEP (Except Federal Republic of Germany, France, Denmark, Norway and Finland), UK, AUS))<br>87.5 – 108 MHz (E ( Middle Easts, Saudi Arabia), AEP (France, Denmark, Norway, Finland, Federal Republic of Germany))<br>AM: 150 – 29999.9 kHz (US, Canadian, E (Except Middle Easts, Saudi Arabia), AEP (Except Federal Republic of Germany), AUS, UK)<br>150 – 26,100 kHz (E (Middle Easts), AEP (Federal Republic of Germany))<br>150 – 285 kHz and<br>530 – 26,100 kHz (E (Saudi Arabia)) |
| Antennas           | AIR/FM/SW: Telescopic antenna<br>MW/LW: Built-in ferrite bar antenna<br>External antenna terminal for AIR/FM as appropriate<br>External antenna terminal for AM (LW/MW/SW)   |
| Speaker            | Approx. 10 cm (4 inches) diameter  |
| Power output       | 380 mW (at 10% harmonic distortion)  |
| Outputs            | Recording output jack (minijack)<br>Output level 0.775 mV (–60 dB)<br>Output impedance 1 kilohm<br>Earphone jack (minijack)  |
| Power requirements | Radio: 4.5 V dc<br>Three size D batteries (IEC designation R20)<br>DC IN 4.5 V jack accepts:<br>• Supplied ac power adaptor for use on 120 V ac, 60 Hz   |

#### Battery life

- Optional DCC-127A car battery cord for use with 12 V car battery (Except AUS)
- Computer/clock: 3 V dc, two size AA batteries (IEC designation R6)
- Radio:
  - Approx. 40 hours (FM reception)
  - Approx. 30 hours (AM/AIR reception) using Eveready No. 1250 batteries
  - Computer/clock: Approx. 1 year using Eveready No. 1015 batteries
- The battery life assumes listening to the radio for four hours a day at normal volume

–Continued on page 2–

#### SAFETY-RELATED COMPONENT WARNING!!

COMPONENTS IDENTIFIED BY SHADING AND MARK  ON THE SCHEMATIC DIAGRAMS AND IN THE PARTS LIST ARE CRITICAL TO SAFE OPERATION. REPLACE THESE COMPONENTS WITH SONY PARTS WHOSE PART NUMBERS APPEAR AS SHOWN IN THIS MANUAL OR IN SUPPLEMENTS PUBLISHED BY SONY.

#### ATTENTION AU COMPOSANT AYANT RAPPORT À LA SÉCURITÉ!

LES COMPOSANTS IDENTIFIÉS PAR UNE TRAME ET UNE MARQUE  SUR LES DIAGRAMMES SCHEMATIQUES ET LA LISTE DES PIÈCES SONT CRITIQUES POUR LA SÉCURITÉ DE FONCTIONNEMENT. NE REMPLACER CES COMPOSANTS QUE PAR DES PIÈCES SONY DONT LES NUMÉROS SONT DONNÉS DANS CE MANUEL OU DANS LES SUPPLÉMENTS PUBLIÉS PAR SONY.

AIR/FM/LW/MW/SW  
PLL SYNTHESIZED RECEIVER  
**SONY**®

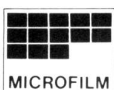

**Dimensions** Approx: 288 x 159 x 52 mm (w/h/d)  
 (11<sup>3</sup>/<sub>8</sub> x 6<sup>3</sup>/<sub>8</sub> x 2<sup>1</sup>/<sub>8</sub> inches)  
 incl. projecting parts and controls with  
 antenna retracted

**Weight** Approx. 1.7 kg (3 lb 12 oz)  
 incl. batteries

The ICF-2001D/2010 is available in various models with differences in tuning bands and frequencies, etc., corresponding to the regulations of different countries.

The main differences are as follows. Please check the type of your unit with respect to each item.

The AM and FM frequency ranges are indicated on the front panel of your unit. For other items, compare your unit with the photos on page 3 and the explanations of "LOCATION AND FUNCTION OF CONTROLS".

| Item                       | Type | Description                           |
|----------------------------|------|---------------------------------------|
| AM frequency range         | 1    | 150 - 29,999.9 kHz                    |
|                            | 2    | 150 - 26,100 kHz                      |
|                            | 3    | 150 - 285 kHz and 530 - 26,100 kHz    |
| FM frequency range         | 1    | 76 - 108 MHz                          |
|                            | 2    | 87.5 - 108 MHz                        |
| AIR band (116 - 136 MHz)   | 1    | Provided                              |
|                            | 2    | Not provided (No AIR key)             |
| SSB reception              | 1    | Provided                              |
|                            | 2    | Not provided (No USB and LSB/CW keys) |
| External antenna terminals | 1    | Provided                              |
|                            | 2    | Not provided                          |

Despite the above differences, the operating procedure of all the units are identical. The differences are clearly described in the text as required.

The photos and illustrations used in this manual represent a typical model.

## WARNING

To prevent fire or shock hazard, do not expose the set to rain or moisture.

To avoid electrical shock, do not open the cabinet. Refer servicing to qualified personnel only.

## Notice for the customers in the United Kingdom IMPORTANT

The wires in the mains lead of the supplied ac power adaptor are coloured in accordance with the following code:

Blue: Neutral  
 Brown: Live

As the colours of the wires in the mains lead of this apparatus may not correspond with the coloured markings identifying the terminals in your plug proceed as follows:

The wire which is coloured blue must be connected to the terminal which is marked with the letter N or coloured black.

The wire which is coloured brown must be connected to the terminal which is marked with the letter L or coloured red.

The MW scanning interval is preset at the factory to 9 kHz. If you use the receiver where the frequency allocation system is based on a 10 kHz interval, such as in the U.S.A. and Canada, change the MW scanning interval following the procedure on page 15.

## FEATURES

- An FM/LW/MW/SW portable receiver with worldwide band coverage. With certain models, the AIR band\* can be also received.
- Quartz controlled PLL (Phase Locked Loop) synthesizer system using a microcomputer makes pinpoint tuning easy.
- Smooth tuning with rotary manual tuning knob.
- Synchronous detector circuit reduces interference from adjacent stations (beats) and distortion due to fading in AM reception.
- Choice of direct, manual, scan, memory or memory scan tuning.
- Up to 32 stations can be memorized for instant tuning at the press of a key. AM mode can also be memorized.
- Programmable timer turns the receiver on and off automatically up to four times a day.
- Sleep timer turns the receiver off automatically after 60, 30 or 15 minutes.
- Three different radio power sources: internal batteries, house current or car battery.

### \* AIR band

The AIR band covers the air traffic control frequencies. You can monitor aviation communications between aircraft and airport towers, such as a pilot's request for instructions, a report of his position, and filing of his flight plans.

## MODEL IDENTIFICATION

— LCD Indication Plates —

AEP Model: France

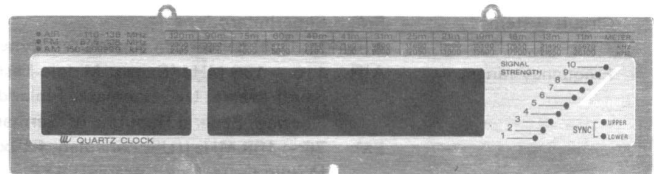

AEP Model: Denmark, Finland, Norway

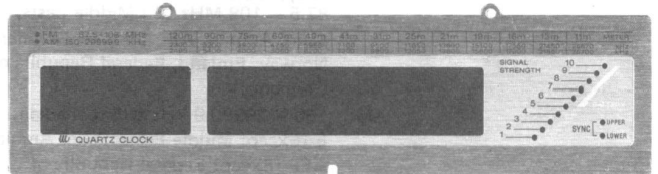

E Model: Saudi Arabia

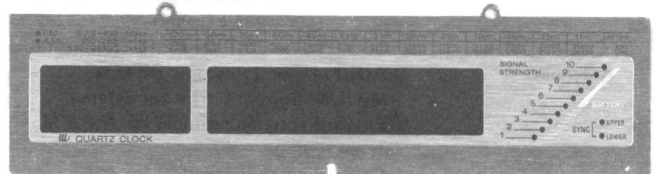

UK Model:

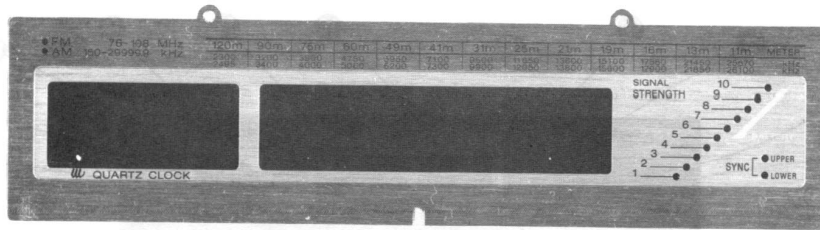

E Model: Middle East

AEP Model: Federal Republic of Germany

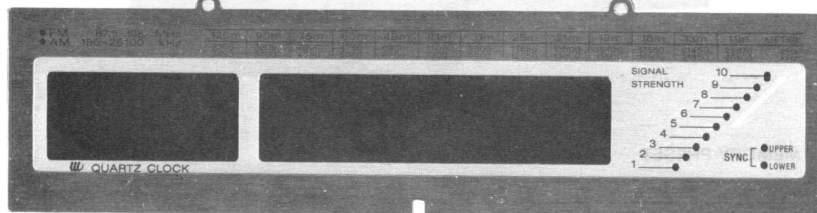

**A**

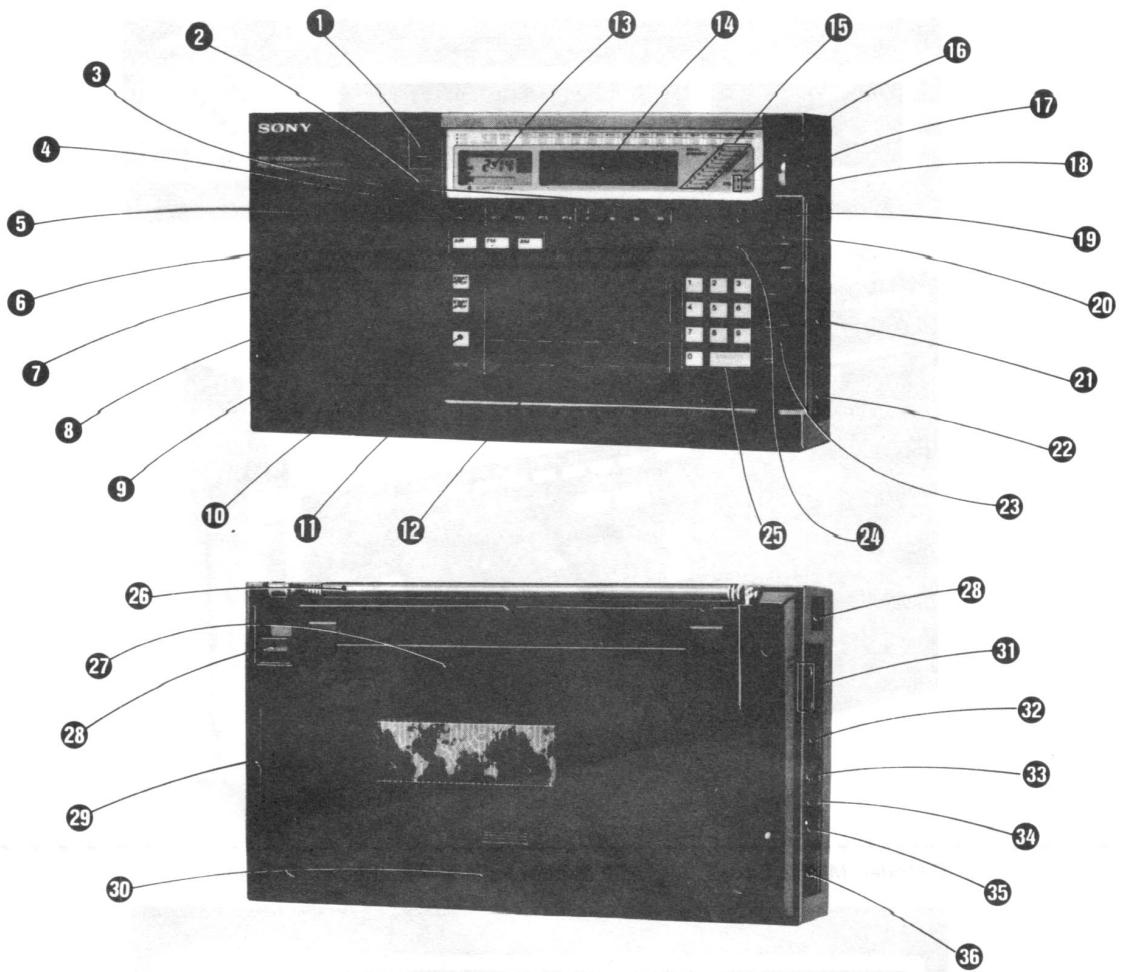

**B**

MEMORY PRESET

|   |        |     |       |       |        |        |     |     |
|---|--------|-----|-------|-------|--------|--------|-----|-----|
|   | 1      | 2   | 3     | 4     | 5      | 6      | 7   | 8   |
| a | SCAN   |     |       |       |        |        |     |     |
| b | DEFINE | LW  | MW    | 120m  | 90m    | 75m    | 60m | 49m |
| c | 41m    | 31m | 25m   | 21m   | 19m    | 16m    | 13m | 11m |
| d | FM     | AIR | SCAN1 | SCAN2 | MW9kHz | MW0kHz | 12A | 24H |

Callouts 1, 2, and 3 point to the 'a', 'b', and 'c' rows respectively. Callouts 4, 5, and 6 point to the 'SCAN1', 'SCAN2', and 'MW9kHz' buttons respectively.

**D**

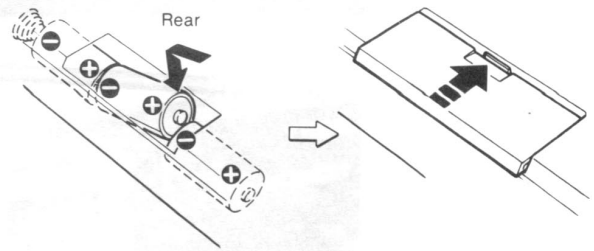

**C**

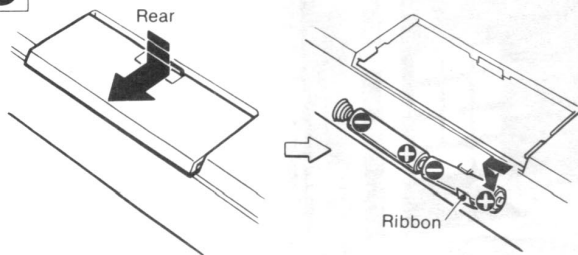

**E**

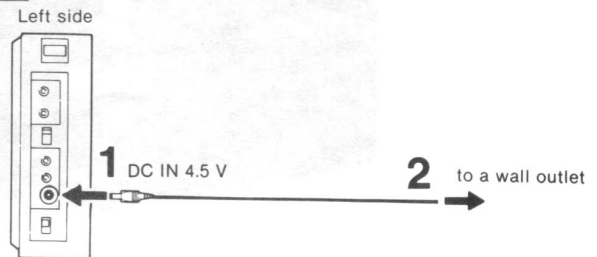



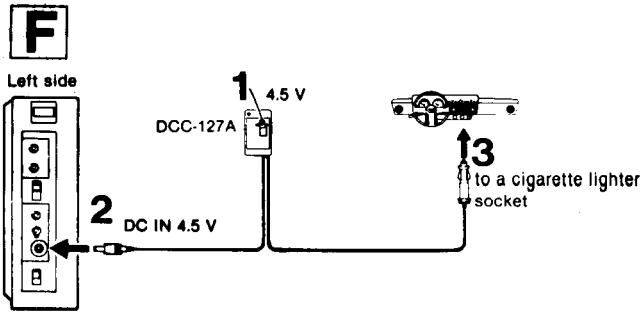

**G-1**

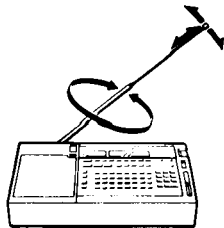

**G-2**

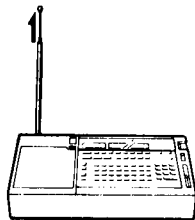

**G-3**

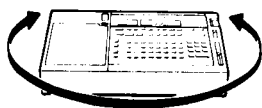

**H-1**

① Antenna connector

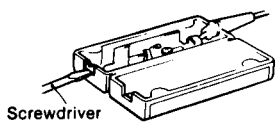

② 12mm 15mm

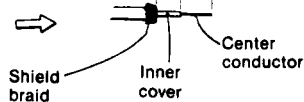

③

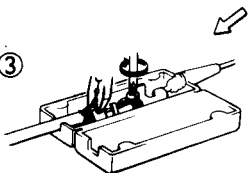

④

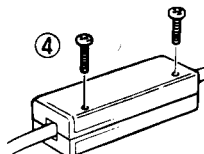

**H-2**

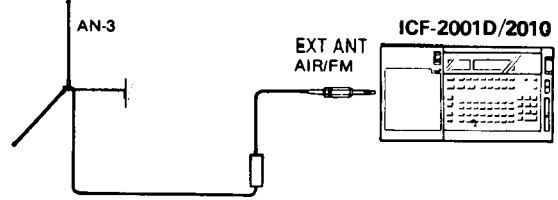

**I**

Press the tabs to fix the ground wire

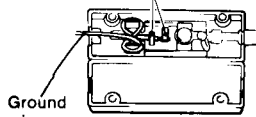

Fil de terre  
Conductor de puesta a tierra

SW external antenna

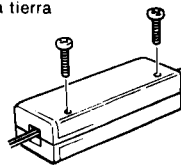
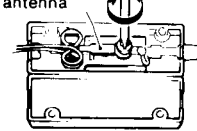

SW external antenna

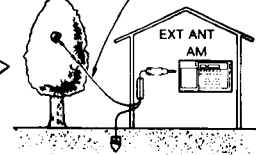

**J**

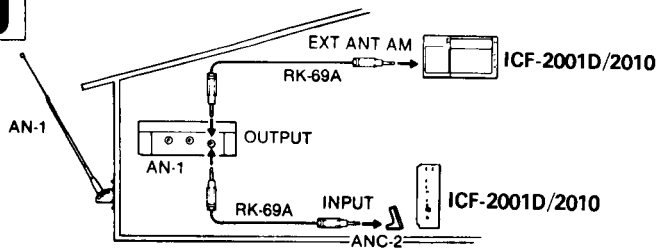

**K**

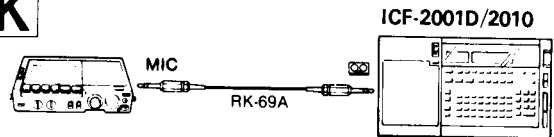

**L**

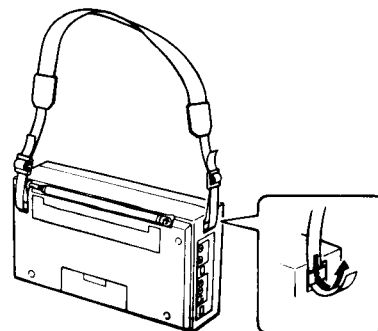

## LOCATION AND FUNCTION OF CONTROLS

See photos **A** on page 4

### 1 POWER switch

After setting the MAIN POWER switch **1** to ON, set to ON to turn on the receiver. To turn the receiver off, set to OFF. To activate the programmable timer, set to TIMER.

### 2 LIGHT key

Press to illuminate the display windows for approximately 15 seconds. If any key on the front panel is pressed or the MANUAL TUNING/TIME ADJ knob **7** is turned, the illumination will remain for another 15 seconds from that point. The illumination will go off automatically 15 seconds after the last key is pressed.

### 3 OPERATION TIME keys (page 16)

To set the operation time of the programmable timer, keeping a PROGRAMMABLE TIMER key **4** pressed, press the 0, 15, 30 or 60 (minute) key.

### 4 PROGRAMMABLE TIMER keys (page 16)

Keeping one of these keys pressed, set the turn-on time, the operation time, and the station to be turned on (the MEMORY PRESET key) by the programmable timer. Four different timer programs can be set on the four PROGRAMMABLE TIMER keys.

### 5 SLEEP timer key (page 15)

Press to set the operation time of the sleep timer. Press this key repeatedly until the desired time, 60, 30 or 15 (minutes), is displayed.

### 6 Band select keys

Select the desired band.

**AIR:** For air band reception (not provided with certain models).

**FM:** For FM reception.

**AM:** For LW, MW and SW reception.

### 7 AM mode select keys (page 10)

Select the appropriate AM mode according to the type of broadcasting and receiving conditions. (With certain models, USB and LSB/CW keys are not provided.)

### 8 SCAN START/STOP key (page 12)

Press to start and stop scanning.

### 9 MEMORY SCAN START/STOP key (page 14)

Press to start and stop memory scanning.

### 10 SKIP key (page 14)

Used to designate the memorized stations to be skipped during memory scanning.

### 11 SHIFT key

To activate the second function of the MEMORY PRESET keys (indicated below the keys in blue), keeping this key pressed, press the required MEMORY PRESET key. (See "Second function of the MEMORY PRESET keys" on page 7)

### 12 MEMORY PRESET keys

One station (its frequency and AM mode) can be memorized with each MEMORY PRESET key. To memorize a station, keeping the ENTER key **2** pressed, press a MEMORY PRESET key.

Most of the MEMORY PRESET keys are dual function. To activate the second function, keeping the SHIFT key **11** pressed, press the MEMORY PRESET key. See "Second function of the MEMORY PRESET keys" on page 7.

### 13 Clock/timer display

Normally the present time is displayed. When the PROGRAMMABLE TIMER key **4** is pressed, the timer program is displayed. When the sleep timer is operating, the operation time of the sleep timer is displayed.

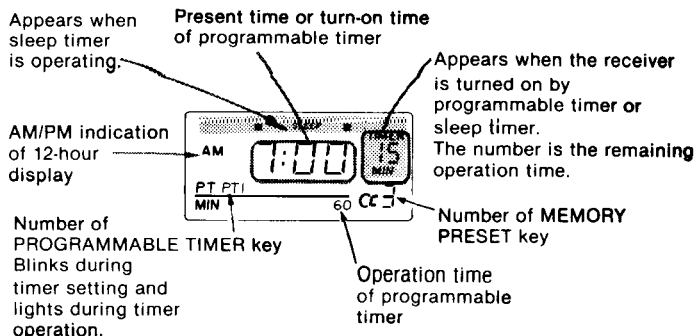

### 14 Frequency display

Displayed as follows.

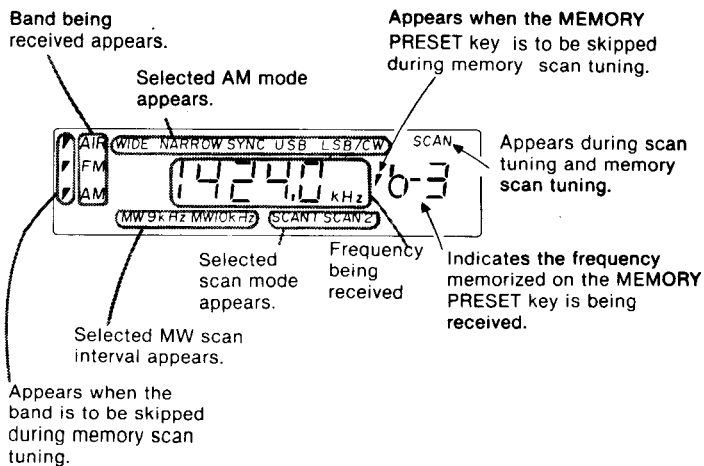

### 15 SIGNAL STRENGTH/BATTERY indicator

Shows the strength of the tuned signal. The more LEDs illuminated, the better the tuning. While the BATTERY CHECK key **13** is pressed, this indicator shows the battery condition.

### 16 SYNC (synchronous detection) indicators (page 11)

When a signal is received with AM mode set to SYNC, one of the SYNC indicators lights to show the sideband selected by the synchronous detector circuit.

Fine tune to the best possible reception with the MANUAL TUNING knob **7**, monitoring the SYNC indicators.

### 17 MANUAL TUNING/TIME ADJ knob

For manual tuning, turn this knob to tune in a frequency. To set the clock, keeping the PRESENT TIME SET key **18** pressed, turn this knob. To set the turn-on time of the programmable timer, keeping the PROGRAMMABLE TIMER key **4** pressed, turn this knob.

### 18 PRESENT TIME SET key

To set the clock, keeping this key pressed, turn the MANUAL TUNING/TIME ADJ knob **17**.

### 19 BATTERY CHECK key

To check the battery condition, keeping this key pressed, monitor the SIGNAL STRENGTH/BATTERY indicator **15**.

**⑩ MANUAL TUNE MODE selector (page 10)**

When this selector is set to FAST, AM frequency is changed by 1 kHz intervals by turning the MANUAL TUNING/TIME ADJ knob ⑦. When the selector is set to SLOW, AM frequency is changed by 0.1 kHz intervals. When the selector is set to LOCK, the frequency of all the bands will not change even if the MANUAL TUNING/TIME ADJ knob is turned. (Clock and timer settings can be made.)

**⑪ AM RF GAIN control**

Normally set to MAX. When the sound of an AM station is distorted due to strong signals, slide it towards MIN. During scan tuning, adjust the stop level of scanning with this control.

**⑫ TONE selector**

Set to the appropriate position according to the program or to your preference.

HIGH: For more treble.

LOW: For less treble.

NEWS: For listening to news.

**⑬ VOLUME control**

Slide towards MAX for more volume.

**⑭ ENTER key**

Used to memorize a station. After tuning in a frequency and selecting AM mode, keeping this key pressed, press a MEMORY PRESET key.

**⑮ DIRECT TUNING keys**

For direct tuning, input a frequency with the keys 0-9 and then press the EXECUTE key.

**⑯ Telescopic antenna (page 11)**

Used for FM, SW and AIR band reception.

**⑰ Stand**

Press the part marked **PUSH UP** to raise the stand. To lower it, press the same part again.

**⑱ Loops for shoulder strap**

**⑲ Information plate**

Pull out the plate to the left to remove, stick the supplied memo sheet on the front side and the supplied information sheet on the rear and replace the plate.

When referring to the information, slide it out as required.

**⑳ Battery compartment (page 8)**

Install the computer/clock batteries and radio batteries.

**㉑ EXT ANT (external antenna) jacks (page 17)**

(Not provided with certain models)

Connect the supplied SW external antenna or an optional external AM antenna to the EXT ANT AM jack. Connect an optional external antenna for FM and AIR reception to the EXT ANT FM/AIR jack.

**㉒ AM ATT (AM attenuator) selector**

Used for AM reception. Normally set to DX. When receiving a strong signal, or at night when it is difficult to pick up a weak signal because of interference from many other signals, set to LOCAL.

**㉓ (recording output) jack.**

Used to record broadcast programs with a tape recorder.

**㉔ (earphone) jack (minijack)**

Connect an earphone or stereo headphones.

When a plug is inserted into this jack, the built-in speaker is disconnected automatically.

When the stereo headphones are connected, the sound is heard in monaural.

**㉕ DC IN 4.5V (external power input) jack**

Connect an ac power adaptor or car battery cord.

**㉖ MAIN POWER switch**

Set to ON to turn on the receiver.

When carrying the receiver, set it to OFF to prevent the receiver from turning on accidentally. When this switch is set to OFF, only the clock operates.

**SECOND FUNCTION OF THE MEMORY PRESET KEYS**

Most of the MEMORY PRESET keys are dual function.

The first function is frequency memorization, and the second is indicated in blue below the key.

To use the second function, keeping the SHIFT key pressed, press the MEMORY PRESET key.

See illustration **[B]** on page 4.

**① L1/L2 SCAN (scan range check) keys**

Keeping the SHIFT key pressed, press the L1 key or the L2 key, and the lowest frequency or the highest frequency of the preset scan range appears on the frequency display.

**② DEFINE scan key (page 12)**

To scan between the frequencies memorized on the a-1 key and the a-2 key, keeping the SHIFT key pressed, press this key.

**③ Band scan keys**

To select the factory-preset scan range, which is a conventional broadcast band, keeping the SHIFT key pressed, press the corresponding key. The frequency range of each broadcast band is indicated on page 13.

**④ Scan mode select keys**

Keep the SHIFT key pressed and press the SCAN 1 key. Scanning will stop automatically when a signal is received.

Keep the SHIFT key pressed and press the SCAN 2 key. Scanning will stop for 1.5 seconds when a signal is received, and will then resume automatically.

**⑤ MW scan interval select keys (page 12)**

Set the MW scan interval to 9 kHz or 10 kHz according to the MW frequency allocation system of your country.

**⑥ Hour display format select keys (page 9)**

Select either 12 hour display or 24 hour display.

The MEMORY PRESET key is illustrated and described as follows in the text of this manual.

**Ex. ② DEFINE scan key**



## COMPUTER/CLOCK BATTERIES

These batteries are used to operate the clock, displays, and microcomputer which controls the receiver and retains the memory. Be sure to keep the batteries installed even when the receiver is operating on other power sources than the radio batteries.

### Battery installation

Insert two size AA batteries (IEC designation R6) with correct polarity, following illustration  on page 4.

As soon as the batteries are installed, 0:00 will appear on the clock display and the clock begins to operate.

### Battery life

About one year of operation can be expected when using Eveready No. 1015 batteries. This assumes listening for four hours a day at normal volume.

When the computer/clock batteries are exhausted, the displays may become faint.

### Replacement of the batteries

Be sure to replace both computer/clock batteries once a year to avoid damage from leaking batteries.

Once the batteries are removed, the memorized frequencies and timer programs are erased and the clock setting is cancelled. Be sure to memorize or set these contents again after replacing the computer/clock batteries.

### Note

When the air is especially dry, the following may be caused by static electricity, but there is no cause for alarm:

- The indication in the clock/timer display and the frequency display disappears.
- Irregular figures appear in the clock/timer display and the frequency display.
- The indication preset at the factory—0:00 or AM 150.0 kHz—appears in the clock/timer or frequency display.
- Frequencies cannot be tuned in.

If any of these things happens, set the MAIN POWER switch to OFF, and reset to ON. If the problem persists, remove and re-install the computer/clock batteries.

## RADIO POWER SOURCES

For receiver operation, the computer/clock batteries and one of the following three radio power sources are necessary.

### RADIO BATTERIES

#### Battery installation

Insert three IEC designation R20 batteries (size D) with correct polarity, following illustration  on page 4.

- The set cannot be operated on the internal batteries when the ac power adaptor or car battery cord is connected to the set.
- When the set is not to be used for a long period of time or is to be operated extensively on other power sources, remove the batteries to avoid damage caused by battery leakage and corrosion.

#### Battery life

You can expect Sony SUM-1(NS) New Super batteries to last for approx. 32 hours for AM/AIR reception and approx. 45 hours for FM reception. This assumes listening for four hours a day at normal volume.

### To check the battery condition

- 1 Set the MAIN POWER switch and the POWER switch to ON.
- 2 Keeping the BATTERY CHECK key pressed, monitor the SIGNAL STRENGTH/BATTERY indicator. If the LEDs do not light up to the green zone, replace all batteries with new ones.

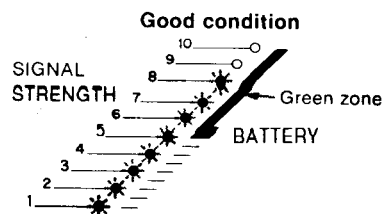

- When the batteries are exhausted, the sound becomes weak or distorted.

### HOUSE CURRENT (except the model available in Australia)

Use the supplied ac power adaptor. The adaptor operates on either 110 (99-121)\*, 120 (108-132), 220 (198-242) or 240 V (216-264 V) ac, 50/60 Hz.

\* Range of voltage allowable shown in parentheses.

- 1 Before connecting the adaptor to a wall outlet, be sure to check whether the input selector is correctly set to your local power line voltage. If necessary, turn the selector with a screwdriver so that you can see the proper voltage figure.

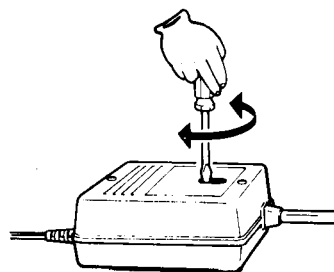

- 2 Connect the adaptor as in illustration  on page 4.

### 12 V CAR BATTERY

Connect the Sony DCC-127A car battery cord (optional) as in illustration  on page 5.

- Before connecting, be sure to read the instruction manual for the car battery cord.
- Reception may be affected by ignition noise while the engine is in operation.

### Notes

- When the ac power adaptor or car battery cord is connected to the DC IN 4.5 V jack, the internal radio batteries (if present) are automatically disconnected.
- If a car battery cord or an ac power adaptor not manufactured by Sony is used, a fuse must be installed in the battery cord or the ac power adaptor and the polarity of the plug must be as illustrated.

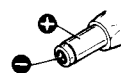

## CLOCK SETTING

When the computer/clock batteries are installed, the clock begins to operate from 0:00.

### To set the clock

- 1 Keeping the PRESENT TIME SET key pressed, turn the MANUAL TUNING/TIME ADJ knob so the display shows present time.
- 2 As soon as you hear the time signal on the telephone, radio or TV, release the PRESENT TIME SET key.

The clock will then begin to operate, showing the precise time of day.

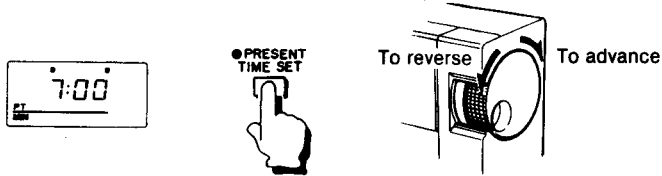

### To change the hour display format

The hour display format of the clock is preset at the factory to 24-hour display. You can change to a 12-hour display as follows:

- 1 Set the MAIN POWER switch and the POWER switch to ON.
- 2 Keeping the SHIFT key pressed, press the 12H key.

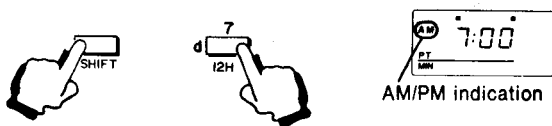

Check the AM/PM indication.

AM 12:00 = midnight PM 12:00 = noon

- To reset to the 24-hour display, keeping the SHIFT key pressed, press the 24H key.
- Once the computer/clock batteries are removed, the 24-hour display is automatically selected.

## DIRECT TUNING

If you know the frequency of a station to be received, you can tune in the station easily by direct tuning.

The numbers in the illustration refer to the sequence of operations.

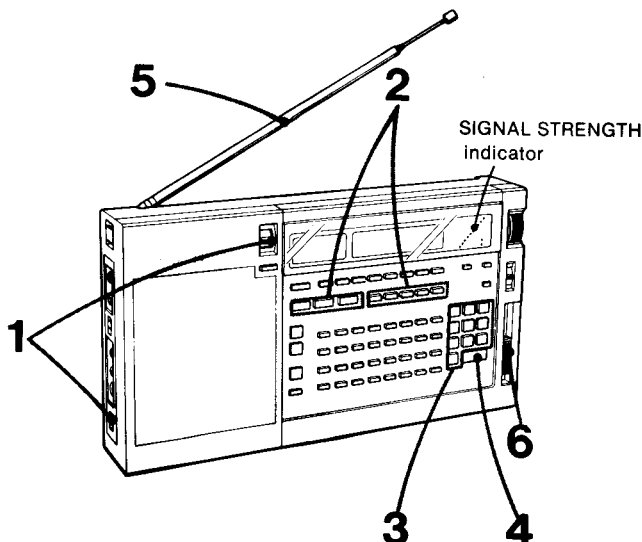

- 1 Set the MAIN POWER switch and the POWER switch to ON.
- 2 Select the desired band.  
For AM reception, select the required AM mode. (See "How to select AM mode" on page 11.)
- 3 Input the frequency of the station to be received with the 0-9 keys.
- 4 Press the EXECUTE key.
- 5 Adjust the telescopic antenna for FM/SW/AIR reception.  
Rotate the set for improved LW/MW reception. See page 11.
- 6 Adjust the volume with the VOLUME control.

After listening, set the POWER switch to OFF.

### HOW TO INPUT A FREQUENCY

#### Example

AM 1,240 kHz



#### FM 92.5 MHz





To input a frequency whose righthand digits are all 0

AM 2,000 kHz

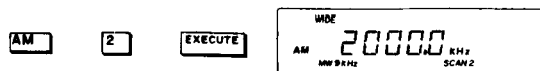

FM 90.0 MHz



In case of 10,000 kHz and 20,000 kHz, however, press **1 0 EXECUTE**, and **2 0 EXECUTE**, respectively.

In case of 200 kHz, 300 kHz, ... 900 kHz, press **2 0 0 EXECUTE**; **3 0 0 EXECUTE**, etc.

● After pressing a key, press the next key within 5 seconds. If you do not, the previous station will return.

● With direct tuning, the frequency is displayed in steps of the following intervals, depending on the bands.

AM: 1 kHz

FM: 0.05 MHz

AIR: 0.025 MHz

If you input a frequency between the intervals, the frequency at the interval just below will be tuned in and displayed. For example, if you input FM 92.540 MHz, FM 92.500 MHz will be tuned in and displayed.

### Error indication

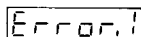

When you input a frequency beyond the receivable frequency range, this indication will blink several times and the previous station will return. → Input a correct frequency.

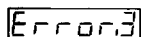

If you set the POWER switch to ON or press the SLEEP key when there is no radio power source, this indication will appear for approx. 5 seconds and then disappear.

→ Check the following.

- The MAIN POWER switch is set to OFF.
- The radio batteries are exhausted.
- The ac power adaptor or the car battery cord is connected to the DC IN 4.5 V jack when battery operation is attempted.
- The ac power adaptor or the car battery cord is not connected correctly to a wall outlet or a cigarette lighter socket of a car.

## MANUAL TUNING

Use manual tuning when you do not know the frequency of the station you want to tune in, or when you want to tune in a station more precisely after scan tuning.

The numbers in the illustration refer to the sequence of operations.

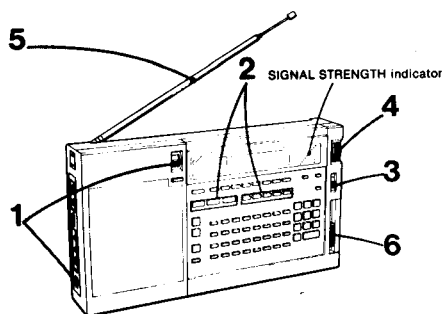

1 Set the MAIN POWER switch and the POWER switch to ON.

2 Select the desired band.

For AM reception, select the required AM mode.

(See "How to select AM mode" on page 11.)

3 Set the MANUAL TUNE MODE selector to SLOW or FAST.

4 Turn the MANUAL TUNING knob to tune in a desired station so that more LEDs of the SIGNAL STRENGTH indicator light.

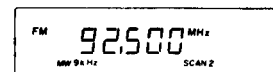
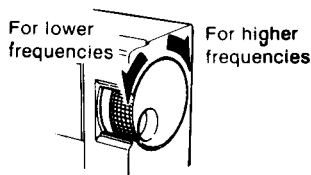

As the MANUAL TUNING knob is turned, the frequency is tuned in and displayed at the following intervals, depending on the bands.

AM: 0.1 kHz (with the MANUAL TUNE MODE selector set to SLOW)

1 kHz (with the MANUAL TUNE MODE selector set to FAST)

FM: 0.05 MHz

AIR: 0.025 MHz

5 Adjust the antenna. See page 11.

6 Adjust the volume with the VOLUME control.

After listening, set the POWER switch to OFF.

### Note

When the upper or lower limit of the band frequency is reached, the frequency no longer changes even if the MANUAL TUNING knob is turned further.

### How to use the MANUAL TUNE MODE selector

The manual tuning interval of AM frequency can be set with the MANUAL TUNE MODE selector, to 0.1 kHz (at SLOW position) or 1 kHz (at FAST position).

After tuning in a station with the selector set to FAST, tune it in more precisely, setting the selector to SLOW. Once the frequency of any band is precisely tuned, set the selector to LOCK. The frequency no longer changes even if the MANUAL TUNING knob is accidentally turned.

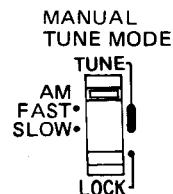

### Note

For AM (LW, MW and SW) reception in SYNC, USB or LSB/CW mode, be sure to set this selector to SLOW.

## FOR IMPROVED RECEPTION

### ANTENNA ADJUSTMENT

#### For FM/AIR reception

Pull out the telescopic antenna to expose its swivel base and adjust its length, angle and direction for optimum reception. For AIR reception, extending two sections of the antenna is recommended. See illustration G-1 on page 5.

#### For SW reception

Pull out the telescopic antenna to its full length and set it vertically. See illustration G-2 on page 5.

● If there is a fluorescent lamp just above the set and reception is noisy, incline and shorten the telescopic antenna.

#### For MW/LW reception

Retract the telescopic antenna. The built-in ferrite bar antenna activates. Since this antenna is directional, rotate the set horizontally for optimum reception, if necessary. See illustration G-3 on page 5.

### Notes

● If reception is unsatisfactory with the telescopic antenna or the built-in ferrite bar antenna, connect an external antenna\*. To connect an external antenna, see page 17.

● In vehicles or in buildings, radio reception may be difficult or noisy. Try listening near a window.

● If the received sound is distorted or noisy, adjust the antenna carefully. For AM reception, set the AM ATT selector to LOCAL.

\* With certain models, the external antenna jacks are not provided.

### HOW TO SELECT AM MODE

Select the appropriate AM mode according to the broadcast or receiving conditions.

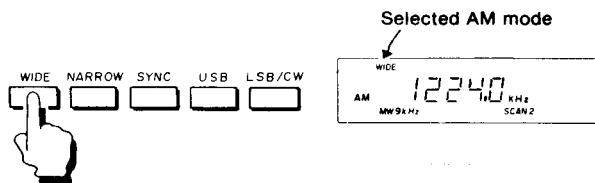

**WIDE:** Normally set to this mode for wider selectivity.

**NARROW:** If reception is interrupted or noisy, set to this mode for narrower selectivity. Reception will be improved.

**SYNC:** If reception is difficult because of beats from adjacent stations or distortion due to fading, which frequently occurs during AM (LW, MW and SW) reception, set to this mode and proceed as in "Tuning using synchronous detection".

**USB:** For USB (upper sideband) reception.\*

**LSB/CW:** For LSB (lower sideband) or CW (International Morse Code) reception.\*

\* With certain models, USB and LSB/CW receptions are not available so these keys are not provided.

### TUNING USING SYNCHRONOUS DETECTION

- 1 Tune in the desired station.
- 2 Press the SYNC key. The SYNC indication will be displayed and the UPPER or LOWER SYNC indicator will light up.
- 3 Set the MANUAL TUNE MODE selector to SLOW.
- 4 Turn the MANUAL TUNING knob slowly so that the other SYNC indicator lights.

Choose the best possible tuning point, monitoring the received sound.

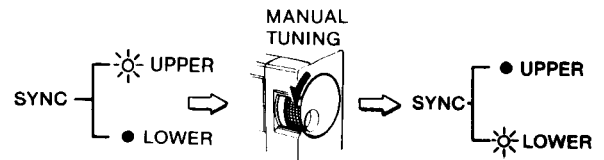

To cancel the SYNC mode, press the SYNC key again. The SYNC indication will disappear.

### What is synchronous detection?

There are two big problems in AM reception: distortion due to fading and interference from adjacent stations. The synchronous detection is effective to these problems.

Distortion due to fading is caused by overmodulation, which occurs when a carrier component of the received signal is attenuated on the way. In this receiver, a pure carrier frequency with no level variation, perfectly synchronized with the original carrier, is generated in the synchronous detector circuit and is mixed with the received signal to compensate the attenuated carrier component. In this way, distortion is remarkably reduced.

On the other hand, AM (LW, MW and SW) broadcasting generally uses double-sideband transmission, in which modulated signals are transmitted using both the upper and lower sidebands (USB and LSB). In most cases one of the sidebands is affected by interference from adjacent stations (beats). In the synchronous detector circuit, one of USB and LSB can be received. This allows clear reception without interference from adjacent stations.

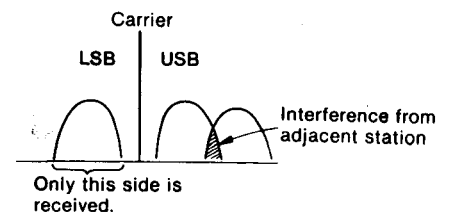

Use scan tuning to automatically scan the stations in the frequency range of a broadcast band or the range which you want. Two scan modes are selectable:

SCAN 1 mode to stop scanning at the first station located, or SCAN 2 mode to stop scanning for 1.5 seconds at each station located.

### HOW TO CHANGE THE MW SCANNING INTERVAL

The MW scanning interval is preset at the factory to 9 kHz to match the frequency allocation system of most countries.

If you use the receiver where the frequency allocation system is based on a 10 kHz interval, such as in the U.S.A. and Canada, change the MW scanning interval as follows:

- 1 Set the MAIN POWER switch and the POWER switch to ON.
- 2 Keeping the SHIFT key pressed, press the MW 10 kHz key.  
(To reset to 9 kHz interval, press the SHIFT key and MW 9 kHz key.)

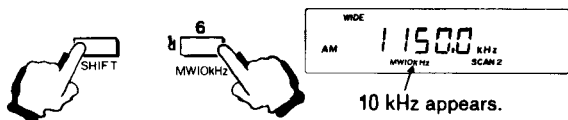

### OPERATION

The numbers in the illustration refer to the sequence of operations.

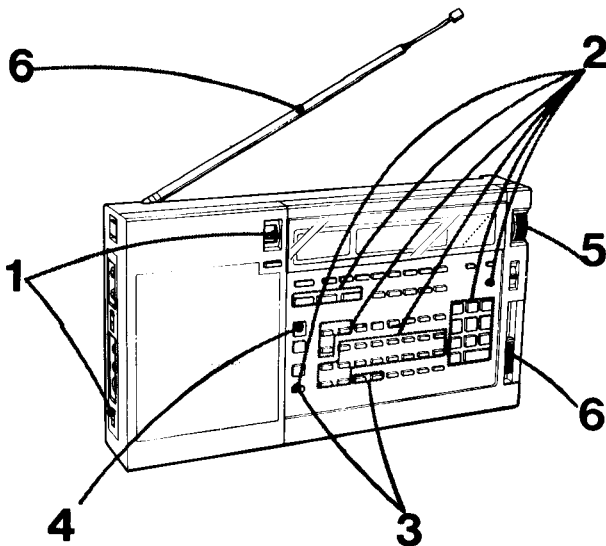

- 1 Set the MAIN POWER switch and the POWER switch to ON.
- 2 Select the broadcast band scan or the DEFINE scan.

### Broadcast band scan

—To scan one of the broadcast bands preset in this receiver (For the frequency range of each band, see the list on page 13)

Keeping the SHIFT key pressed, press the MEMORY PRESET key with the required band indication, LW through AIR.

Example: SW 31 m band (9,400 - 10,000 kHz)

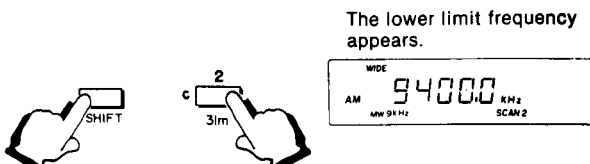

### DEFINE scan

—To scan between the desired frequencies, in a part of a broadcast band or beyond a broadcast band

① Memorize the lower limit frequency and the upper limit frequency to the a-1 and a-2 keys as follows:

Tune in the frequency with direct tuning, and keeping the ENTER key pressed, press the a-1 or a-2 key.

Example: FM 90 MHz - 100 MHz

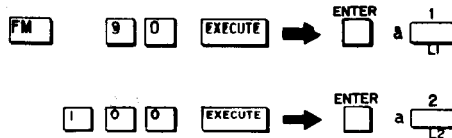

② Keeping the SHIFT key pressed, press the DEFINE key.

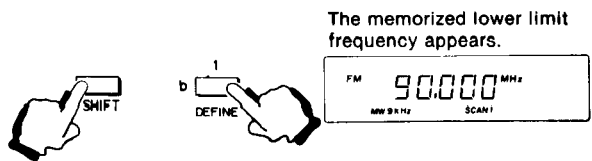

3 Select the scan mode. Keeping the SHIFT key pressed, press the SCAN 1 or SCAN 2 key.

SCAN 1 —To stop scanning at the first station located



SCAN 2 —To stop scanning for 1.5 seconds at each station located

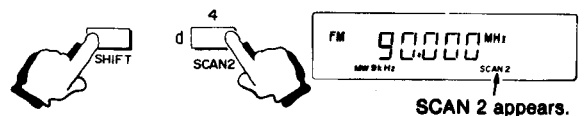

\* SCAN 2 mode is factory-preset.

4 Press the SCAN START/STOP key to start scanning.

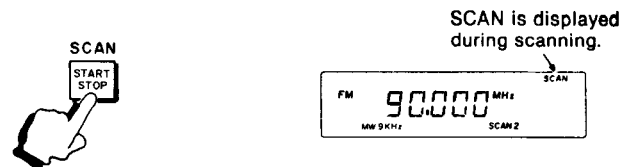

● To resume scanning in SCAN 1 mode, press the SCAN START/STOP key again. Repeat this procedure until the desired station is located.

● In SCAN 2 mode, press the SCAN START/STOP key when the desired station is located. The station is tuned in continuously.

● When the upper limit frequency is reached, the receiver will scan back to the lower limit with a beep.

5 If necessary, tune in the station precisely with the MANUAL TUNING knob.

6 Adjust the antenna and the volume.

After listening, set the POWER switch to OFF.

## BROADCAST BANDS

You can designate a broadcast band to be scanned from the following, by pressing the SHIFT key and the corresponding MEMORY PRESET key.

| Broadcast band |                   | Frequency range to be scanned        | Scanning interval |
|----------------|-------------------|--------------------------------------|-------------------|
| LW             |                   | 150 - 285 kHz                        | 3 kHz             |
| MW             |                   | 531 - 1620 kHz<br>(530 - 1620 kHz)   | 9 kHz<br>(10 kHz) |
| SW             | 120 m             | 2250 - 2550 kHz                      | 5 kHz             |
|                | 90 m              | 3150 - 3450 kHz                      |                   |
|                | 75 m              | 3850 - 4050 kHz                      |                   |
|                | 60 m              | 4700 - 5110 kHz                      |                   |
|                | 49 m              | 5900 - 6250 kHz                      |                   |
|                | 41 m              | 7000 - 7400 kHz                      |                   |
|                | 31 m              | 9400 - 10000 kHz                     |                   |
|                | 25 m              | 11500 - 12150 kHz                    |                   |
|                | 21 m              | 13500 - 13900 kHz                    |                   |
|                | 19 m              | 15000 - 15700 kHz                    |                   |
|                | 16 m              | 17450 - 18000 kHz                    |                   |
| 13 m           | 21350 - 21950 kHz |                                      |                   |
| 11 m           | 25570 - 26100 kHz |                                      |                   |
| FM             | See page 1.       | 76.0 - 108.0 MHz<br>87.5 - 108.0 MHz | 0.05 MHz          |
| AIR*           |                   | 116 - 136 MHz                        | 0.025 MHz         |

\* Not provided with certain models.

● The frequency ranges of the SW meter bands to be scanned are somewhat wider than those indicated on the front panel of the receiver.

● The frequencies between two SW meter bands can be scanned with the DEFINE scan at a 5 kHz scanning interval.

### To check the frequency range to be scanned

Keeping the SHIFT key pressed, press the L1 (a-1) key or the L2 (a-2) key. The lower limit frequency or the upper limit frequency appears on the frequency display.

● The selected scanning range is memorized even after the receiver is once turned off or the station beyond the range is tuned in.

### Notes

● Since scanning stops with a stronger signal than the preset level, it may stop a little before or after the exact frequency of a station. If this happens, tune in the station precisely with the MANUAL TUNING knob.

● When scanning does not stop at all during AM (LW, MW or SW) reception, make sure the AM RF GAIN control (right side) is set to MAX and the AM ATT selector (left side) is set to DX.

● When scanning stops at a noise or many unwanted stations during AM reception, slide the AM RF GAIN control slightly toward MIN. Then, set the AM ATT selector to LOCAL.

● AM mode, scanning range setting, scan mode and MW scanning interval cannot be changed during scanning.

## MEMORY TUNING

Once the frequencies of the stations are memorized, all you have to do is to push a key.

Up to 32 stations can be memorized to the a-1 to d-8 MEMORY PRESET key.

### HOW TO MEMORIZE A STATION

The numbers in the illustration refer to the sequence of operations.

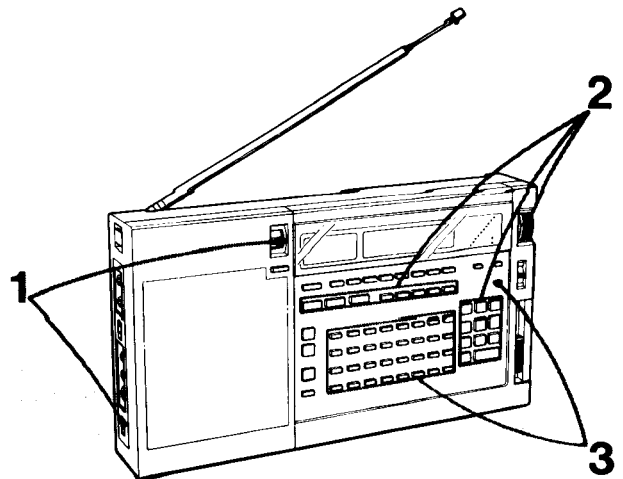

- 1 Set the MAIN POWER switch and the POWER switch to ON.
- 2 Tune in the desired station using any tuning method—direct tuning (page 9), manual tuning (page 10) or scan tuning (page 14), and set AM mode appropriately when receiving AM stations.
- 3 Keeping the ENTER key pressed, press one of the MEMORY PRESET keys.

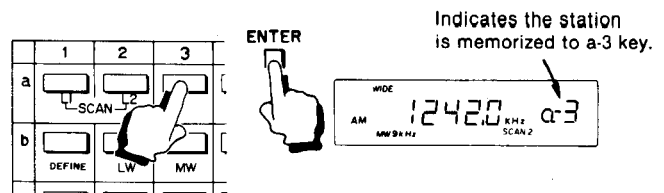

Repeat steps 2 and 3 for each MEMORY PRESET key.

- If you memorize another station to a key to which you have already memorized a station, the previous station will be erased. You cannot erase a station without memorizing another station.
- AM 150 kHz are memorized to all the keys at the factory.

### Note

After replacing the computer/clock batteries, be sure to memorize the stations again. The memory contents will be erased when the batteries are removed.

## SCAN TUNING

### Example of memorizing stations

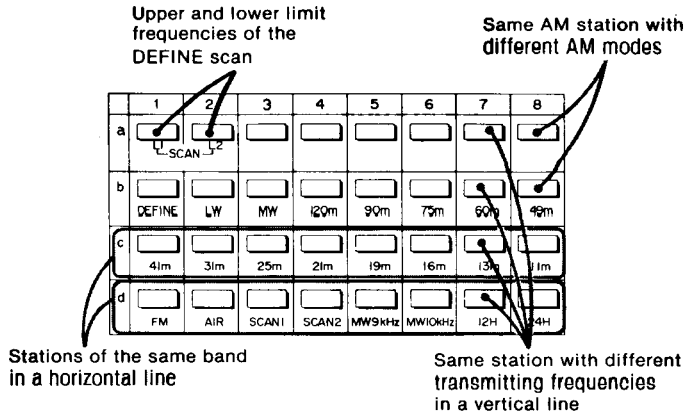

### To check the memory

After memorizing the stations, press each MEMORY PRESET key in turn to check the stations have been memorized correctly.

### To check the memory while receiving a station

Keeping the SKIP key pressed, press the MEMORY PRESET keys in turn. The memorized frequencies appear on the display in turn, while the station remains received. By releasing the keys, the frequency being received will be displayed. This is convenient for deciding the MEMORY PRESET key to which the just received station is to be memorized.

## HOW TO RECEIVE A MEMORIZED STATION

Turn on the receiver and press the MEMORY PRESET key. The memorized frequency will be received.

## HOW TO USE THE MEMO SHEET

Note the memorized frequencies on the supplied memo sheet and stick it to the information plate. You can refer to it by sliding out the plate.

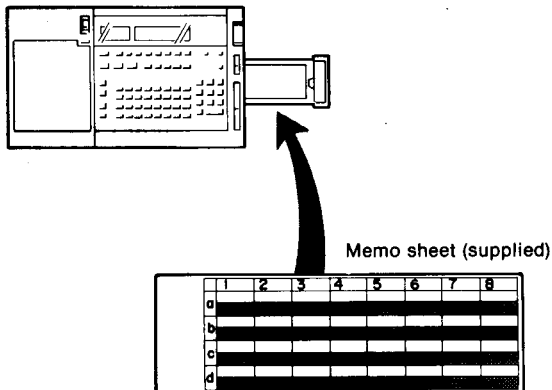

## MEMORY SCAN TUNING

The stations memorized to the MEMORY PRESET keys are scanned from the a-1 key to d-8 key in sequence and scanning stops automatically for 5 seconds or so when a signal is received. Only the desired stations can be scanned by skipping the other memorized stations.

The numbers in the illustration refer to the sequence of operations.

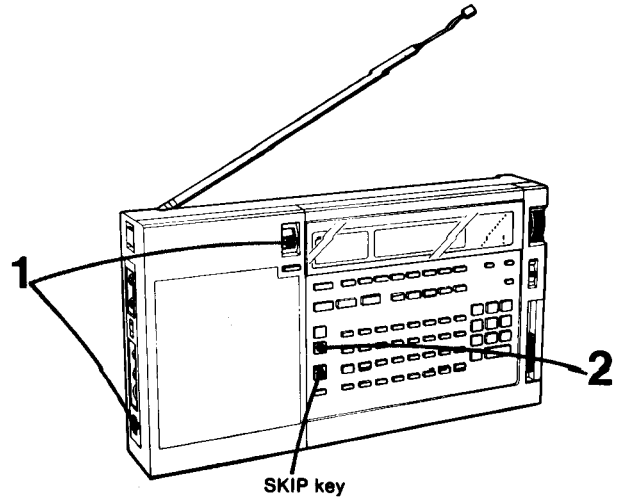

- 1 Set the MAIN POWER switch and the POWER switch to ON.
  - 2 Press the MEMORY SCAN START/STOP key.
- The stations memorized to the a-1 key to the d-8 key will be scanned in sequence.

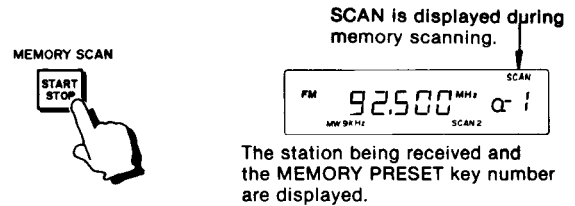

When a signal is received, scanning will stop for 5 seconds and will then resume.

To stop scanning, press the MEMORY SCAN START/STOP key.

## TO SCAN STATIONS OF SOME KEYS OR OF A CERTAIN BAND ONLY

### Skip mark

When a MEMORY PRESET key is pressed initially, the ▽ (skip) mark is displayed with the number of the key. This mark means that the key is skipped during memory scanning.

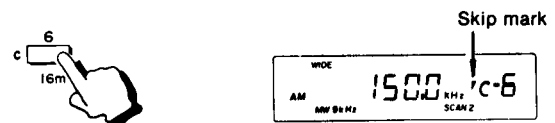

The skip mark initially appears with all the MEMORY PRESET keys. It will be erased automatically once a station is memorized to the key, so that the station can be located by memory scanning.



**To scan stations of some keys only**

- 1 Press the MEMORY PRESET key to which the station you want to skip is memorized.
- 2 Keeping the SKIP key pressed, press the same MEMORY PRESET key again so the ▽ mark appears.

**To scan stations of a certain band (FM, AM or AIR\*) only**

Example: To scan FM stations only

Keeping the SKIP key pressed, press the AM band select key (and the AIR band select key for certain models) once or twice so that the ▽ mark appears on the upper left of the band indication.

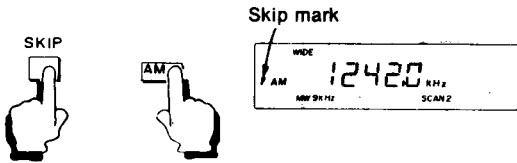

\* The AIR band is not provided with certain models.

**To check the keys to be skipped while receiving a station**

Keeping the SKIP pressed, press the MEMORY PRESET keys from the a-1 key to the d-8 key in turn and check the ▽ mark. By releasing the keys, the previous station is received.

**To erase the ▽ mark**

- 1 Press the MEMORY PRESET key for which you want to erase the ▽ mark.
- 2 Keeping the SKIP key pressed, press the same MEMORY PRESET key again. The ▽ mark will be erased.

**Notes**

- The ▽ mark with the band indication has priority over that of a MEMORY PRESET key. So, when the ▽ mark is set with the band indication, the key is skipped even if the ▽ mark of the key itself has been erased.
- The SHIFT key and SKIP key do not function during memory scanning.

**Error indication**

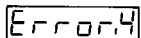

When all the MEMORY PRESET keys are skipped during memory scanning, this indication will appear for approx. 5 seconds and will then disappear. ➡ Erase the ▽ mark of the required keys. See "To erase the ▽ mark".

**SLEEP TIMER OPERATION**

**—To turn off the receiver automatically**

The receiver can be turned off automatically after 15, 30 or 60 minutes by the sleep timer.

- 1 Set the MAIN POWER switch to ON.
- 2 Set the POWER switch to OFF (or TIMER).
- 3 Select the sleep timer operation time by pressing the SLEEP key. With each push of the key, the digits of the operation time changes from 60 to 30 to 15 (minutes), then the receiver is turned off. With another push, 60 will appear again.

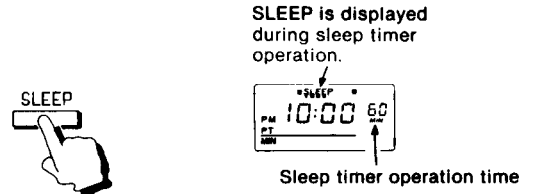

- 4 Tune in the desired station.

The remaining operation time is displayed as the time elapses. The receiver will be turned off automatically after the preset time.

**To turn off the receiver before the preset time**

Press the SLEEP key repeatedly so that no digits of the operation time are displayed. Or, set the POWER switch ON, and then reset to OFF.

**To cancel the sleep timer and continue listening**

Set the POWER switch to ON.

**Error indication**



If you press the SLEEP key when there is no radio power source, this indication will appear for approx. 5 seconds and will then disappear. ➡ Check the following.

- The MAIN POWER switch is set to OFF.
- The radio batteries are exhausted.
- The ac power adaptor or the car battery cord is connected to the DC IN 4.5 V jack when battery operation is attempted.
- The ac power adaptor or the car battery cord is not connected correctly to a wall outlet or a cigarette lighter socket of a car. When the power is supplied, the receiver is turned on and will be turned off automatically after the displayed time has elapsed.

## PROGRAMMABLE TIMER OPERATION

### —To turn on the receiver automatically

Any memorized station can be turned on automatically at the desired time and turned off after 60, 30 or 15 minutes by the programmable timer. Four timer programs can be set.

#### Before setting the timer

- Set the MAIN POWER switch and the POWER switch to ON.
- Memorize the stations to be turned on to the MEMORY PRESET keys.
- Adjust the VOLUME control to normal listening level.

#### HOW TO SET THE TIMER

Set the following three items.

- ① Turn-on time
- ② Timer operation time (60, 30 or 15 minutes)
- ③ Station to be turned on (number of the MEMORY PRESET key)

**Example:** To receive the station memorized to the a-3 key for 30 minutes from 6:00 a.m.

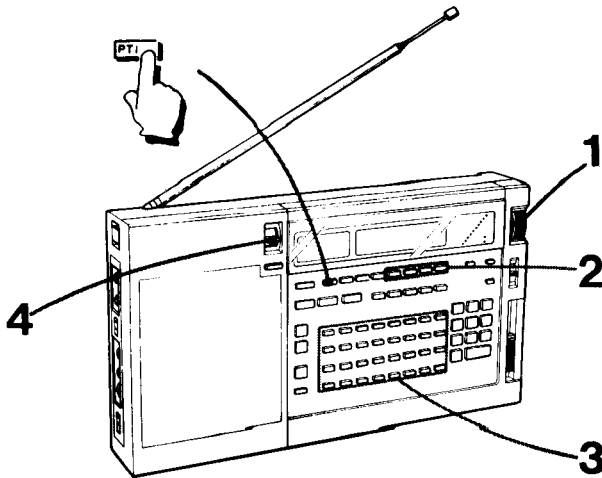

- 1 Keeping the PT1 key pressed, turn the TIME ADJ knob to set the turn-on time.

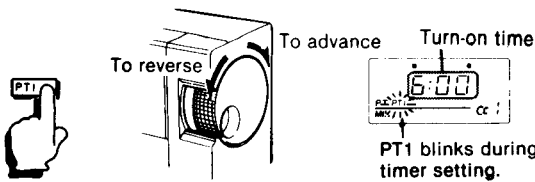

For 12 hour display, check the AM/PM indication.  
AM 12:00 = midnight, PM 12:00 = noon

- 2 Keeping the PT1 key pressed, press one of the OPERATION TIME keys (60, 30 or 15 minutes) to select the timer operation time.

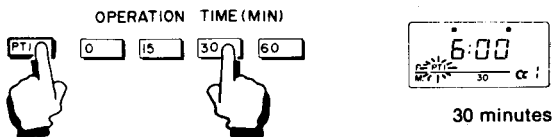

- 3 Keeping the PT1 key pressed, press the MEMORY PRESET key to which the station you want to receive is memorized.



Repeat the same procedure for setting other programs on PT2, PT3 and PT4 keys.

- 4 Set the POWER switch to TIMER.

The receiver will be turned on at the preset time.  
The remaining operation time is displayed as the time elapses.  
The receiver will be turned off automatically after the preset time.

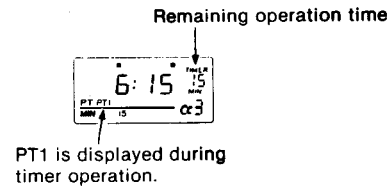

#### To turn off the receiver before the preset time

Set the POWER switch to OFF. Reset it to TIMER to turn on the receiver at the next preset time.

#### To check the timer programs

When the POWER switch is set to ON, press the PROGRAMMABLE TIMER key.

When the POWER switch is set to TIMER or OFF, press the SLEEP key, and then the PROGRAMMABLE TIMER key.

The preset timer program is displayed while the PROGRAMMABLE TIMER key is kept pressed.

#### Note

During timer operation, the other timer programs cannot be checked.

#### To cancel the timer program

Set a new program, and the previous program will be cancelled.

#### How to use the OPERATION TIME 0 key

When you do not want to turn on the receiver on a particular day only, set the operation time to 0 by pressing the PROGRAMMABLE TIMER key and the OPERATION TIME 0 key.

The receiver will not be turned on at the preset time.

Later, reset the operation time appropriately to turn on the next day.

## Examples of four timer programs

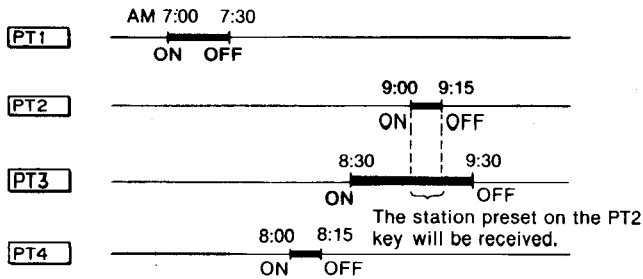

- The stations will be received in the order of the preset turn-on times. (PT1 → PT4 → PT3 → PT2 in the above example.)
- When two programs overlap, priority is given in the order from PT1 key to PT4 key. In the above example, the station preset on the PT2 key will be received from 9:00 to 9:15 and the station preset on PT3 key will return from 9:15 to 9:30.

### To use the sleep timer after setting the timer programs

Press the SLEEP key and tune in the desired station. You can fall asleep listening to the radio and woken up by the other program.

- The programmable timer has priority over the sleep timer. So, if the turn-on time of the programmable timer comes during the sleep timer operation, the station preset on the PT key will be received.

### Error indication

Error

During programmable timer operation, none of the keys on the front panel except the LIGHT key and the BATTERY CHECK key nor the MANUAL TUNING/TIME ADJ knob function. When you touch a key or the knob, this indication will appear for approx. 5 seconds and will then disappear. ➔ To operate the keys or the knob, set the POWER switch to ON.

## EXTERNAL ANTENNA CONNECTION

(Only for models with the external antenna jacks provided)

### FOR FM/AIR BAND RECEPTION

In a steel-frame building, a mountainous area, at a distance from the transmitter or in a location where ignition noise is severe, FM/AIR band reception may be unsatisfactory with the telescopic antenna. In this case, connect the optional Sony AN-3 VHF antenna or other appropriate external antenna.

### Connection

See illustration **H** on page 5.

- 1 Connect the 50-75 ohm coaxial cable to the supplied antenna connector.
  - ① Fold the tabs on the antenna connector.
  - ② Prepare the end of the cable as illustrated.
  - ③ Fix the center conductor and shield braid as illustrated.
  - ④ Close the lid and tighten the screws.
- 2 Connect the antenna connector to the EXT ANT AIR/FM jack of the receiver.

### Notes

- Locate an outdoor antenna as far away from the street as possible.
- For further details, refer to the antenna instruction manual.

### FOR SW RECEPTION

Usually, the telescopic antenna is sufficient for SW reception. However, in a building or for more stable SW reception, the use of the supplied SW external antenna is recommended.

### Connection

See illustration **I** on page 5.

- 1 Connect the ground wire (if necessary) and the spade lug of the SW external antenna to the terminals on the supplied antenna connector, close the lid and tighten the screws.
- 2 Connect the antenna connector to the EXT ANT AM jack of the receiver.

When reception is noisy, connect one end of a ground wire to the antenna connector as illustrated and the other end directly to a convenient earth ground.

### Notes

- When an external antenna is connected to the EXT ANT AM jack, the built-in ferrite bar antenna does not function.
- Never connect a ground wire to a gas pipe. Doing so could cause a fire.
- When there is lightning and you are using an external antenna, immediately disconnect the ac power adaptor (if connected) from the wall outlet. Never touch the antenna wire during a lightning storm.

### FOR MW/LW RECEPTION

Use an optional AN-1 wide range antenna for better reception.

### Connection

See illustration **J** on page 5.

Connect the OUTPUT of the antenna controller\* and the INPUT of the antenna coupler\* with the RK-69A connecting cord\* or connect the OUTPUT of the antenna controller and the EXT ANT of the ICF-2001D/2010 with the connecting cord.

\* supplied with the AN-1 wide range antenna.

1-2. BLOCK DIAGRAM

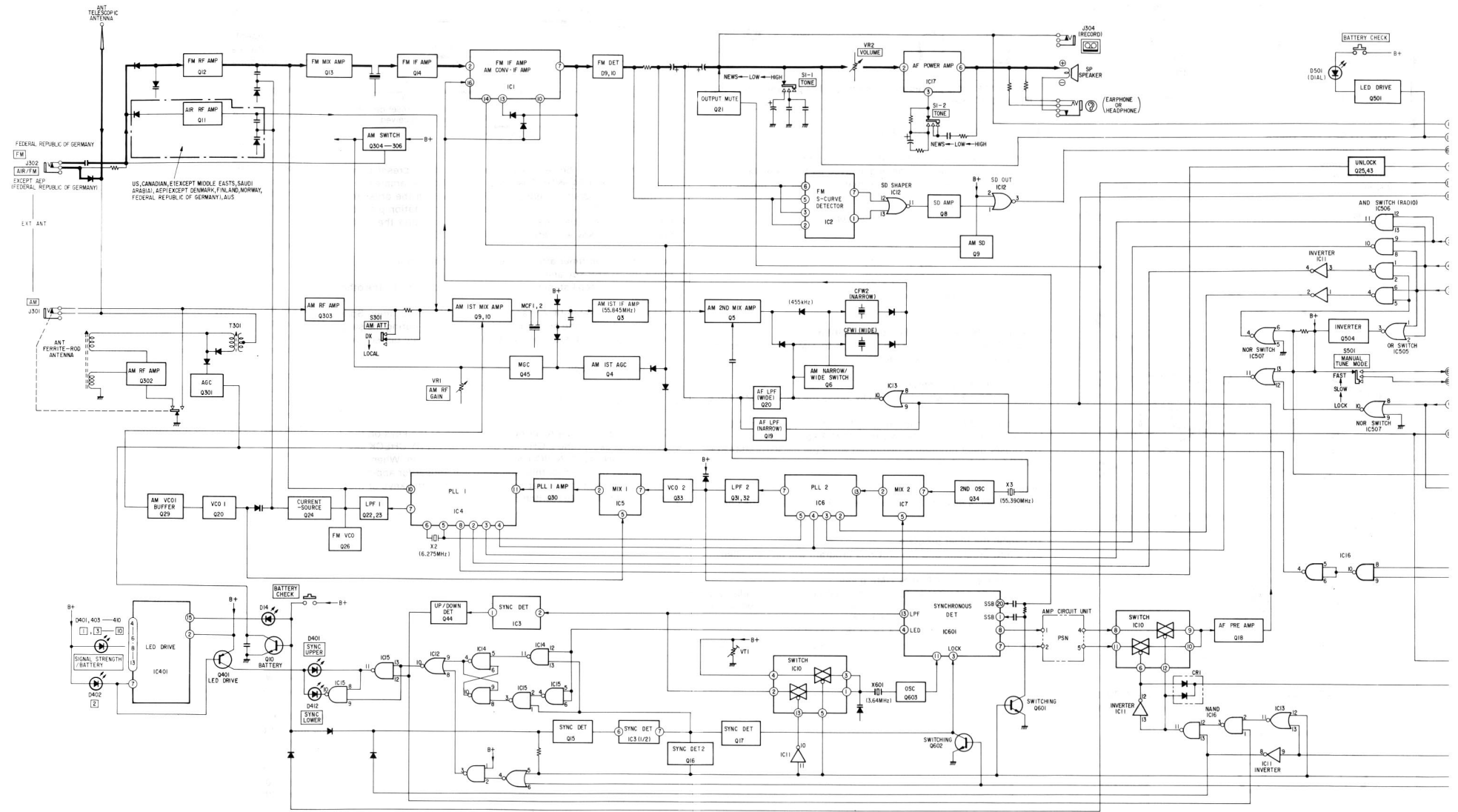

# ICF-2001 D/2010 ICF-2001 D/2010

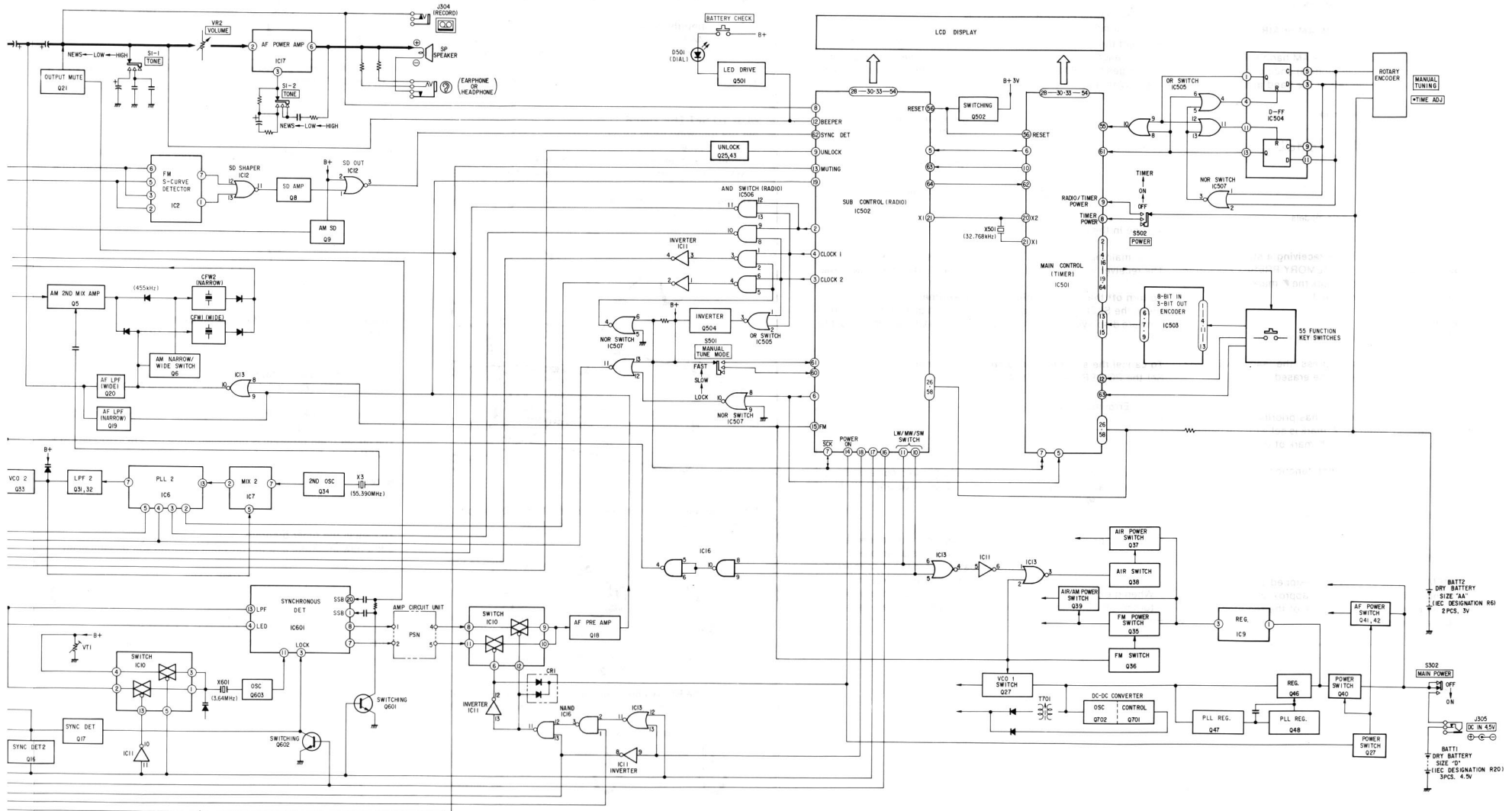



## TROUBLESHOOTING GUIDE

Should any problem occur with the set, make the following simple tests to determine whether or not servicing is required. If the problem persists after you have made these tests, consult the nearest Sony dealer for further information.

### GENERAL

#### No clock/timer display

- Incorrect polarity of computer/clock batteries. See page 8.
- Weak computer/clock batteries.

#### Display is dim.

- Weak computer/clock batteries.
- The set is being used in extremely high temperatures or in a place with excessive moisture.

#### Sound is not heard at all.

- Weak radio batteries.
- Incorrect polarity of radio batteries. See page 8.
- The VOLUME control is slid down completely.
- The earphone is plugged in.

#### Very weak or interrupted sound, or unsatisfactory reception.

- Weak radio batteries.
- Tuning or antenna adjustment is not correct.
- ➔ Tune in precisely with the MANUAL TUNING knob. For antenna adjustment, see page 11.
- Weak signal.
- ➔ In a vehicle or in a building, listen near a window.
- ➔ For AM reception, set the AM RF GAIN control to MAX and the AM ATT selector to DX.

### TUNING

#### A frequency cannot be input in direct tuning.

- The next key was not pressed within 5 seconds after a key has been pressed.

#### Scanning does not stop.

- In SCAN 2 mode, scanning resumes after a station is received for 1.5 seconds. ➔ Set to SCAN 1 mode. See page 12.
- Weak signal.
- ➔ Adjust the antenna.
- ➔ For AM reception, set the AM RF GAIN control to MAX and the AM ATT selector to DX.

#### Scanning does not begin.

- A strong station is being received. ➔ Press the SCAN START/STOP key repeatedly until scanning begins.
- There are many strong stations.
- ➔ For AM reception, gradually slide the AM RF GAIN control toward MIN. If it is set to MAX, set the AM ATT selector to LOCAL.

#### A frequency cannot be memorized.

- Incorrect memorizing procedure. ➔ Keeping the ENTER key pressed, press one of the MEMORY PRESET keys.

#### The memorized frequency cannot be tuned in even if the MEMORY PRESET key is pressed.

- The memory has been erased. ➔ After replacing the computer/clock batteries, be sure to memorize the stations again.

#### A required station cannot be received during memory scanning.

- The station is skipped as the ▽ mark is displayed with the MEMORY PRESET key indication or the band indication.
- ➔ Erase the ▽ mark. See page 15.
- The station is weak.
- ➔ Adjust the antenna.
- ➔ For an AM station, set the AM RF GAIN control to MAX and the AM ATT selector to DX.

### PROGRAMMABLE TIMER

#### The receiver does not turn on at the preset time.

- The POWER switch is not set to TIMER.
- The memory of the timer setting has been erased. ➔ After replacing the computer/clock batteries, be sure to reset it.
- The MAIN POWER switch is set to OFF.
- The timer operation time is set to 0.

### ERROR INDICATIONS

**Error.1** (Appears during direct tuning.)

- A frequency beyond the receivable range has been input.
- The band of the input frequency (AIR, FM or AM) is selected incorrectly.

**Error.2** (Appears during programmable timer operation.)

- The programmable timer is operating and the key or the control you have touched cannot be activated.

**Error.3** (Appears when the POWER switch is set to ON or when the SLEEP key is pressed.)

- The MAIN POWER switch is set to OFF.
- Weak radio batteries.
- Incorrect polarity of radio batteries.
- The ac power adaptor or the car battery cord is not connected securely.
- Battery operation is attempted while an ac power adaptor or a car battery cord is connected to the DC IN 4.5 V jack, but not to a wall outlet or a cigarette lighter socket.

**Error.4** (Appears during memory scanning.)

All the memorized stations are skipped. ➔ Erase the ▽ mark. See page 15.

## SECTION 2 DISASSEMBLY

**Note:** Follow the disassembly procedure in the numerical order given.

### REAR CABINET

- 1 Remove battery lid and 5 (five) batteries.
- 2 Remove six (6) screws, +BTP 3x10, and one (1) screw, +BTP 3x8.

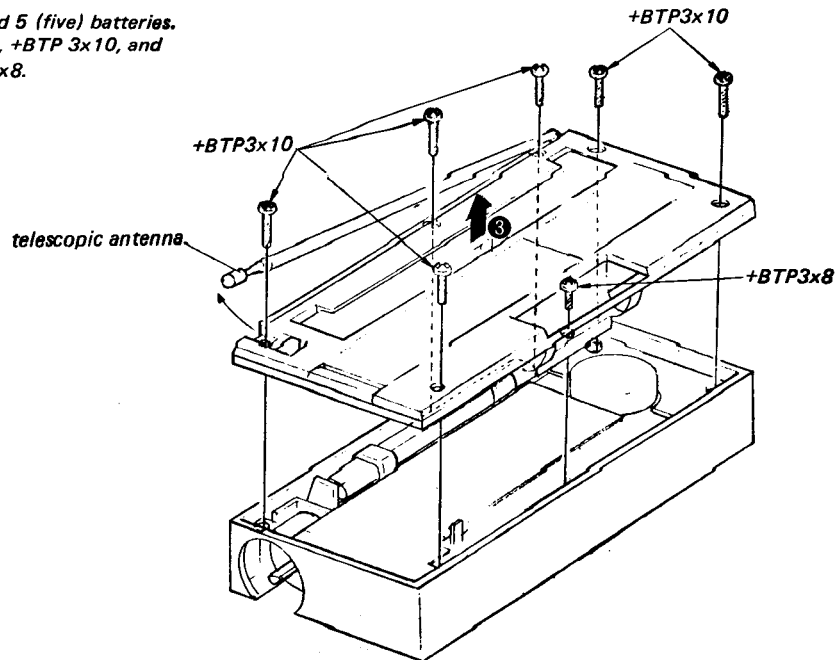

### MAIN BOARD (1)

- 1 Unsolder lead wire (BRN).

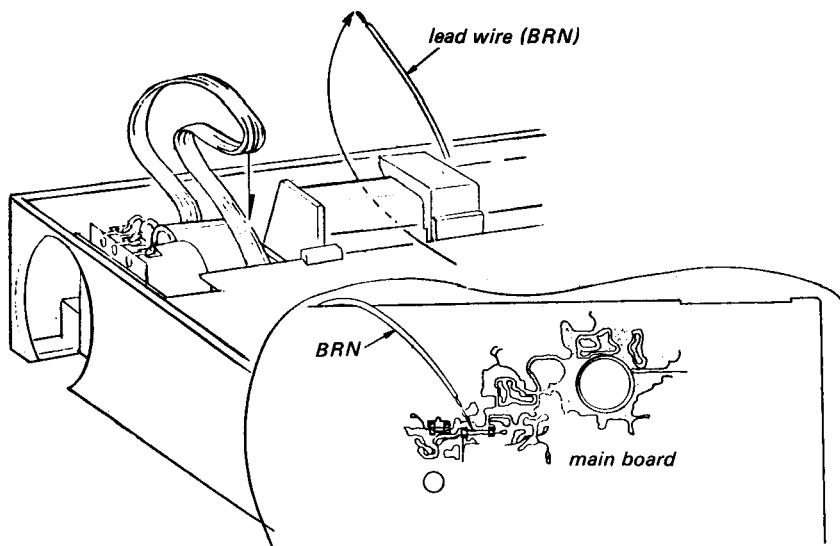

**MAIN BOARD (3)**

- ④ Lift up the jack board by releasing jack rings from case holes and by releasing slide switch knob from control knob grooves.  
Do not break 4 (four) lead wires of ferrite-rod antenna.

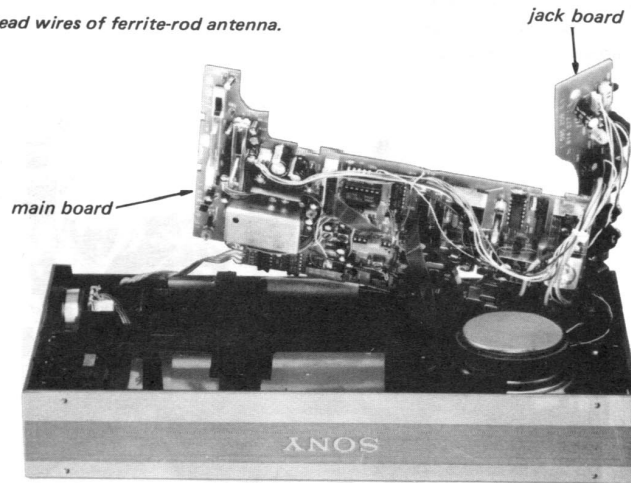

- ⑤ Lift up main board by releasing switch and control slides from switch and control knobs.  
Do not break 4 (four) lead wires of ferrite-rod antenna.



**MAIN BOARD (2)**

- ② Remove three screws.

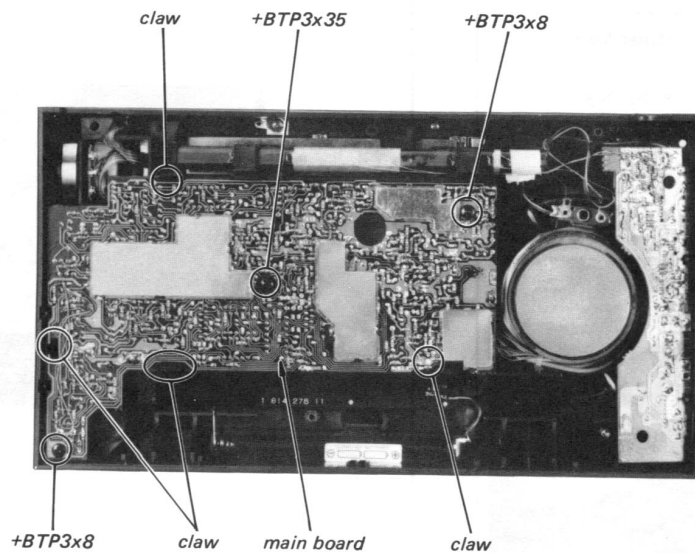

- ③ Unlock chassis claws from main board.

## CHASSIS

- 1 Disconnect flexible board from main board by unlocking flexible board connectors CN1 and CN2. To unlock flexible board connectors, pull up their movable locking sections. To lock flexible board connectors, push on movable locking sections.

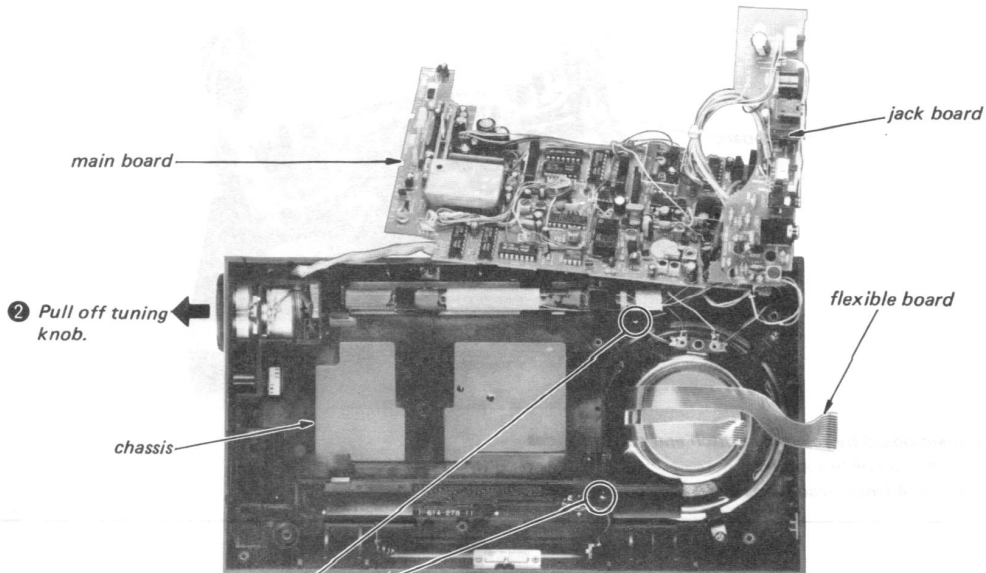

- 2 Pull off tuning knob.
- 3 Remove 2 (two) screws, +BP3x8.
- 4 Lift the chassis up. Key board comes with chassis.

## LCD INDICATION PLATE

- 1 Remove 1 (one) screw, +BTP2.6x5.
- 2 Unlock 2 (two) claws of cabinet from LED board.

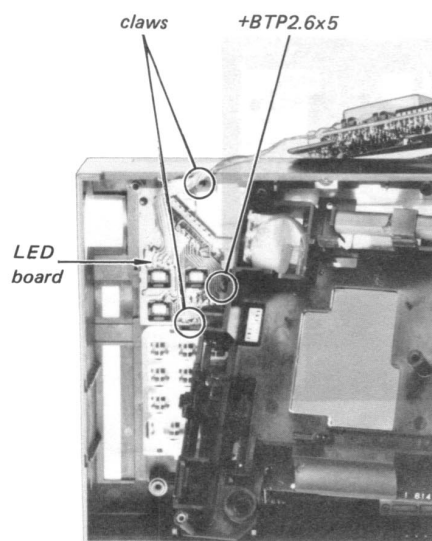

## External 3V power-supply connection.

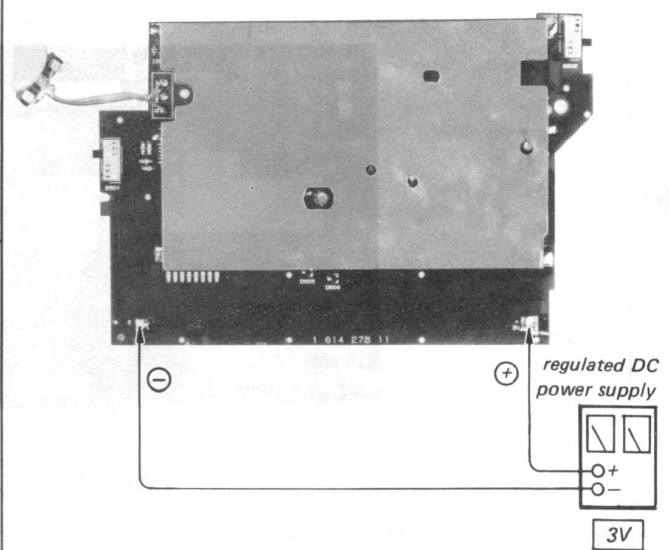

- 1 Reconnect flexible board to main board.
  - 2 Connect 2 (two) external power supplies, 4.5V DC and 3V DC to appropriate points, and some checking and adjustments can be made to main, jack and LED boards.
- Additional extension speaker lead wires can help make checkings easier for viewing front-panel controls.*

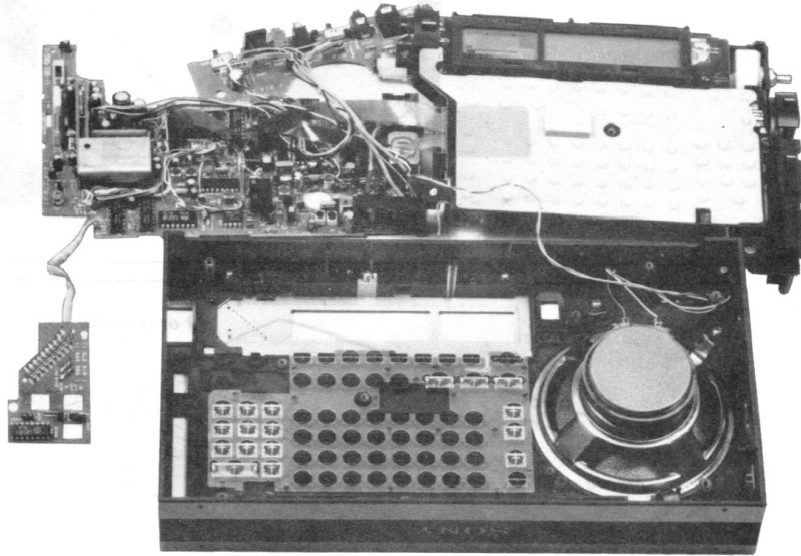

External 4.5V power-supply connection.

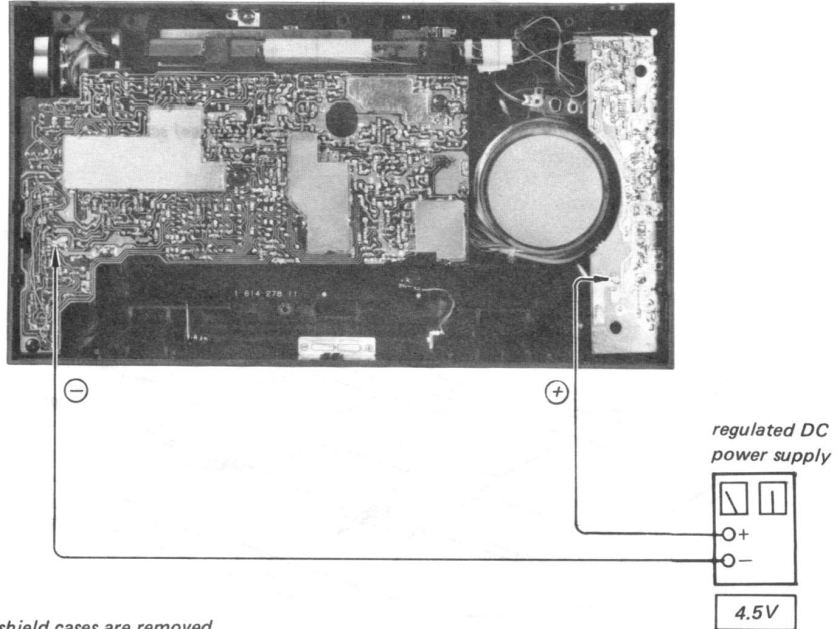

*Note: When shield plates and shield cases are removed, make sure to install jumper-wire connections between lands to which they are installed, because shield plates and cases are providing function as jumper wires between lands.*



**KEY BOARD**

- ① Remove 2 (two) screws, +BP3x8.
- ② Unlock 3 (three) claws of chassis from keyboard.
- ③ Unscrew rotary encoder.

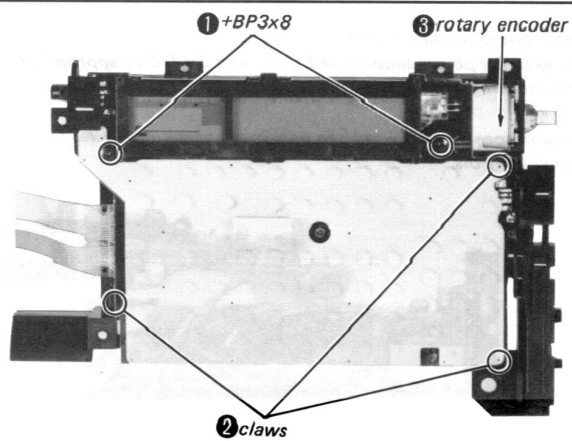

**LCD INDICATION PLATE**

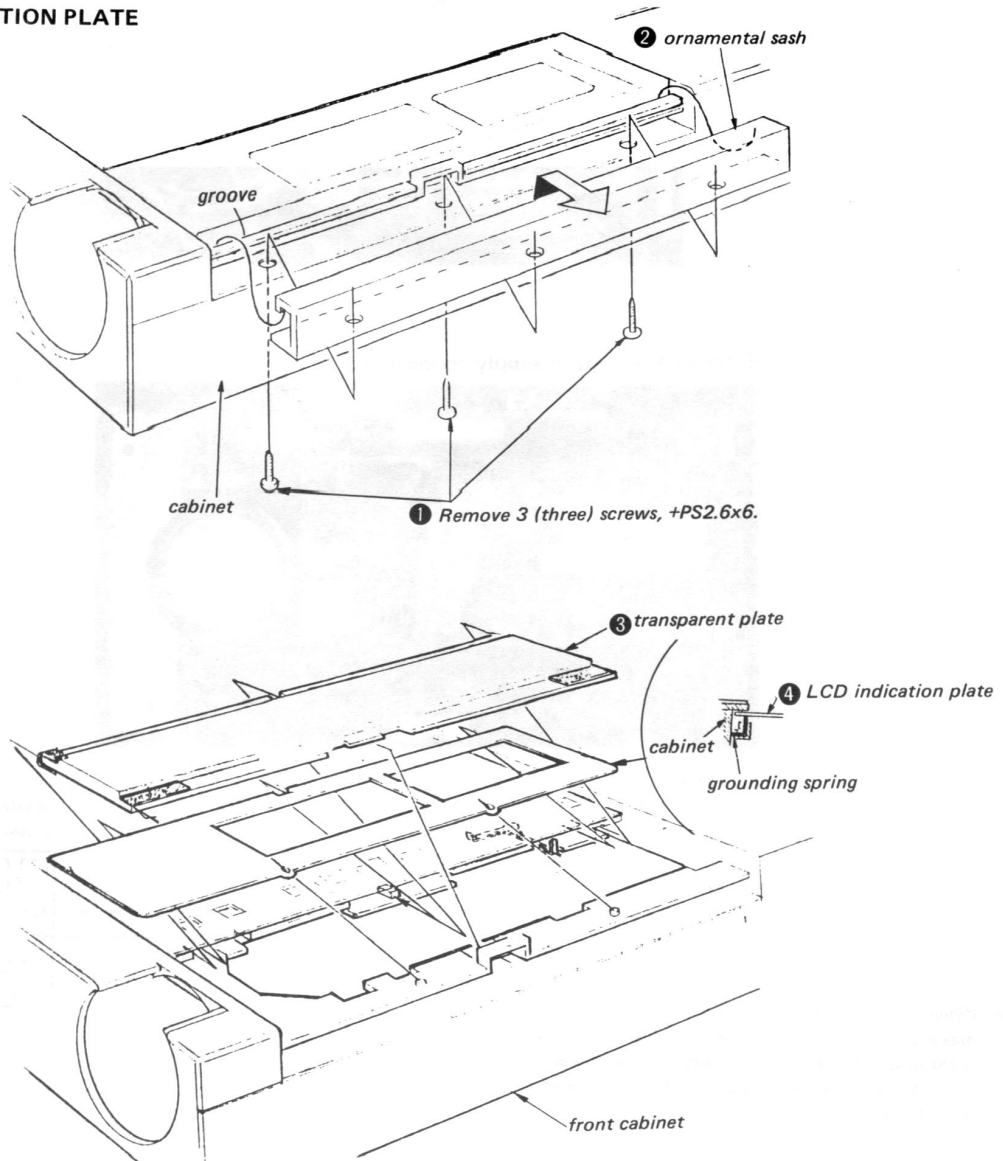

LCD PANEL

① Unsolder shield plate (J).

shield plate (J)

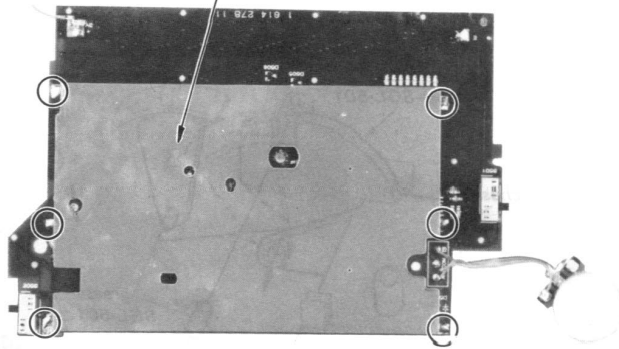

② Remove 6 (six) screws, PTPWH 2x6.

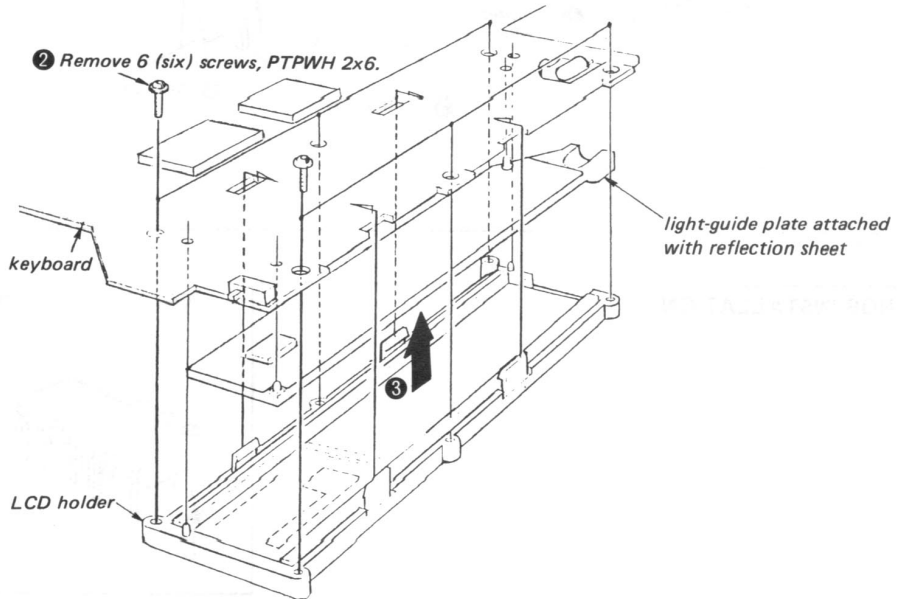

④ Remove 2 (two) rubber connectors. Note orientation of them. Inside conductor sections of them should be in recutangler to conductors of LCD.

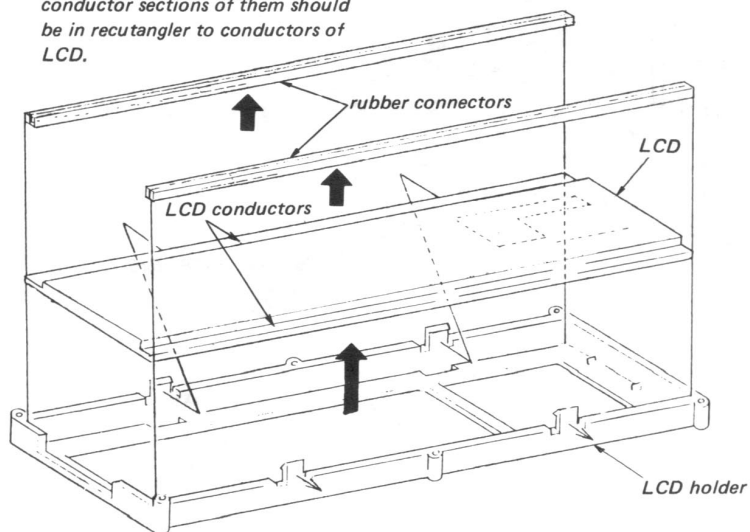

POWER KNOB INSTALLATION

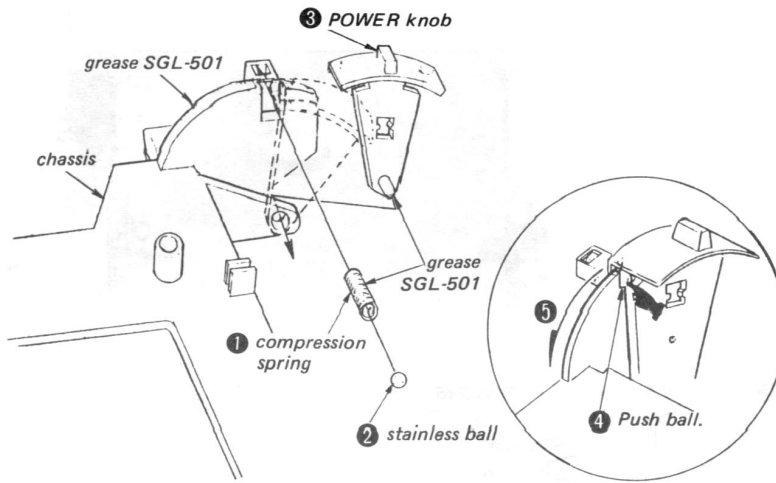

S.F.L KNOB INSTALLATION

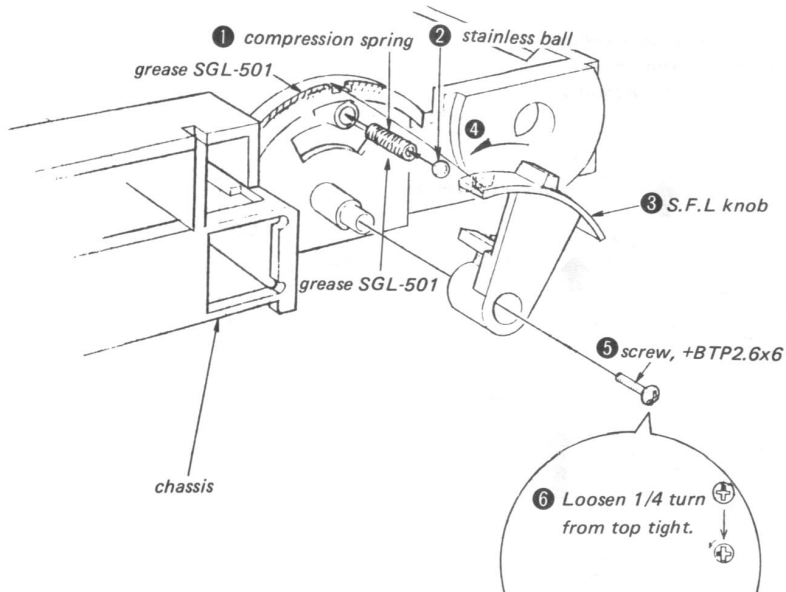

INSTALLATION OF IC601

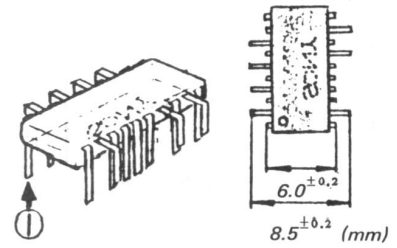

## SECTION 3 ADJUSTMENTS

### 3-1. ADJUSTMENTS

**Note:**

1. Disassembly is required to perform electrical adjustments. Refer to SECTION 2 "DISASSEMBLY". Two regulated DC power supplies are needed for a complete operation of the set. The set does not work good only with a 4.5V DC supply. Be sure to connect two power supplies to the proper points shown.
2. Positions of controls and switches are as follows unless otherwise specified.
  - MAIN POWER switch: ON
  - POWER switch: ON
  - AM ATT switch: DX
  - MANUAL TUNE MODE: as required
  - TONE control: HIGH
  - VOLUME control: as required
  - All key switches: as required
3. When shield plates/cases are removed, be sure to connect jumper wires across appropriate soldering lands to recover electrical connections without shield plates/cases.
4. Checkings to the key-input operation of the key board can be made independently by grounding pin 9 (UNLOCK) of IC502, i.e., by macking a locked condition.

#### TIMER-CLOCK FREQUENCY ADJUSTMENT

**Note:** Remove shield plate (J) on the Key Board referring to the DISASSEMBLY section. Make jumper-wire connections, or re-install shield plate (J) after connecting frequency counter.

**Setup:**

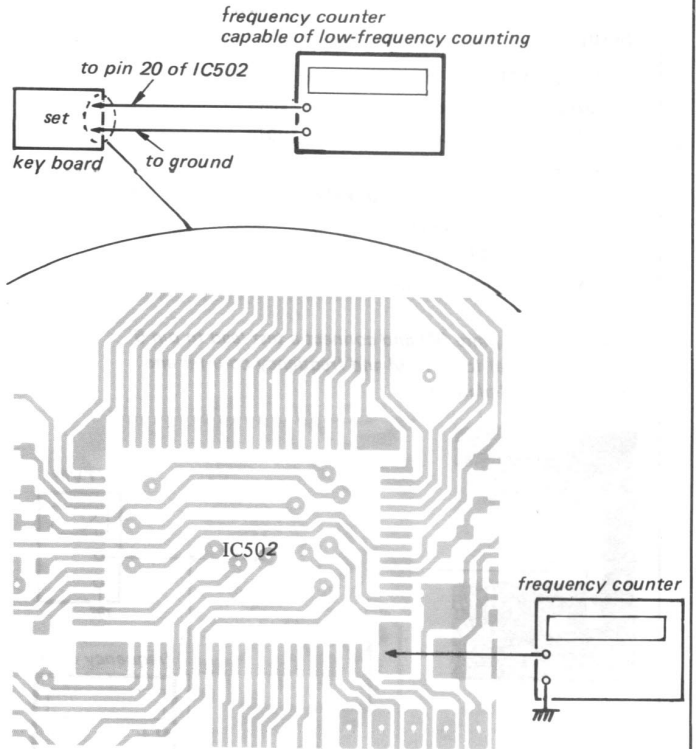

**Procedure:**

Adjust CT501 for a 32.7680 kHz counting.

**Adjustment Location:**

— key board —

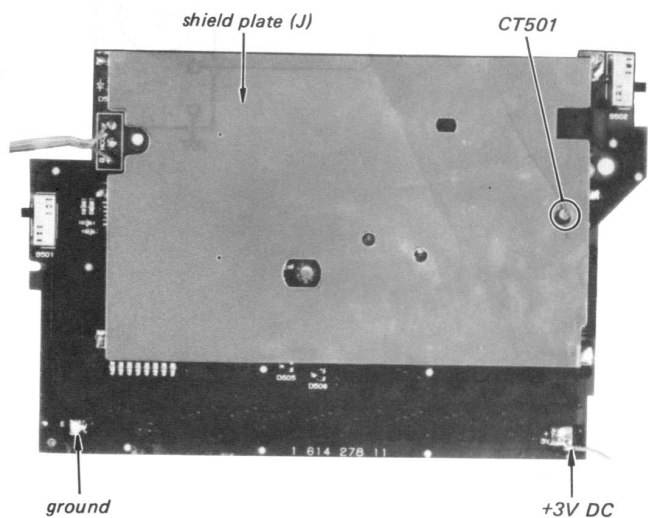

**SYNC ADJUSTMENT**

**Note:** Frequency setting may alter when adjusted with shield plate (K) removed from sync board.

USB and LSB/CW modes are not provided for sets to the Middle East and Saudi Arabia.

**Setup:**

- Band: AM
- Mode: as directed
- AM RF GAIN control: as adequate
- Frequency: as directed  
(11,800.0 kHz when AM RF SSG is used)
- MANUAL TUNE MODE: SLOW
- SYNC switch: as directed

Remove shield plate (K) and connect a test lead to pin 6 (varicap voltage) for VTVM and frequency counter and re-install shield plate (K)

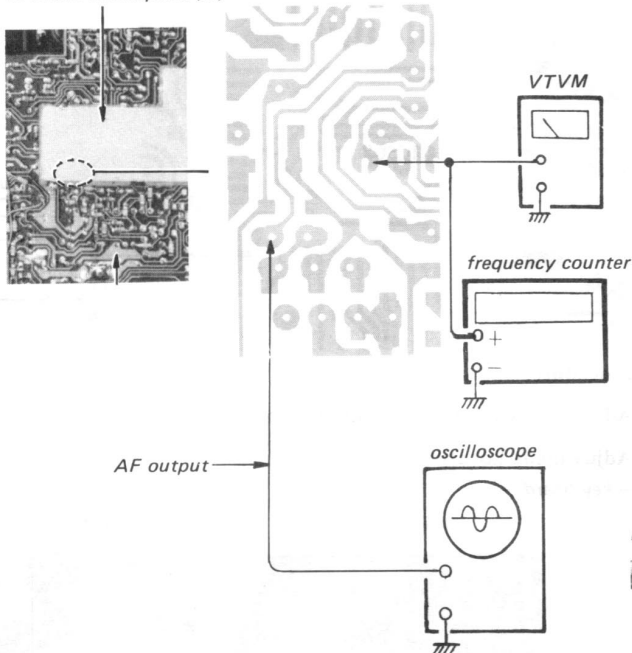

**Procedure:**

1. Correctly and just tune in the set to a known, stable and strong AM station in NARROW and SYNC OFF modes.
2. Set mode to USB.
3. Adjust VT1 for a 1.5V DC VTVM reading.
4. Adjust CT601 for a zero-beat note and waveform.



5. Turn SYNC switch on and, adjust VT2 and set it to the point at which SYNC LOWER indicator just turns off to SYNC UPPER indication. Slowly turn VT2 back to the point at which SYNC UPPER indicator just turns off to SYNC LOWER indication, and leave VT2 as is.



6. Turn MANUAL TUNING knob to obtain a frequency indication just 100 Hz above the carrier of the station being received. (only "one" advancement in the first digit). Now, the SYNC UPPER indicator should lit.
7. Frequency counter should read 3.640 MHz ±100 Hz.

**Adjustment Location:**

— main board —

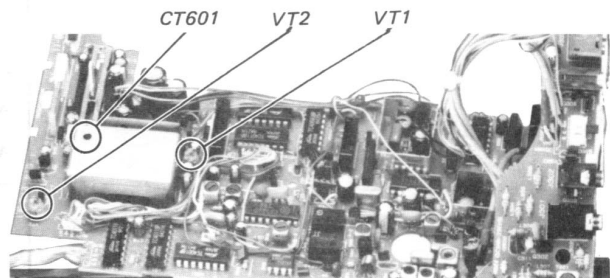

**PLL1 FREQUENCY ADJUSTMENT**

**Setup:**

Band: FM  
 Frequency: 89.300 MHz

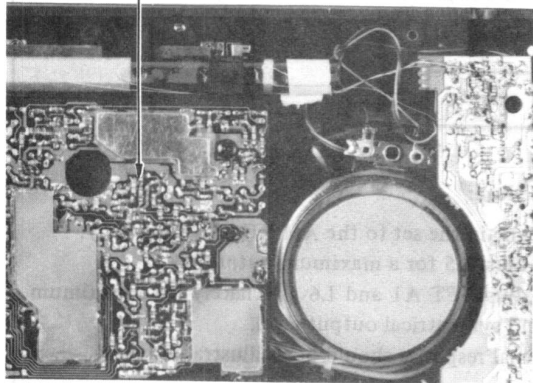
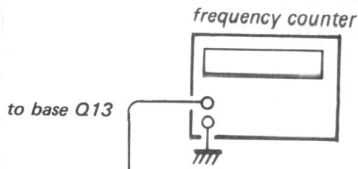

**Procedure:**

Adjust CT4 for a 100.000000 MHz or 100 MHz  $\pm$  30 Hz reading.

**Adjustment Location**

— main board —

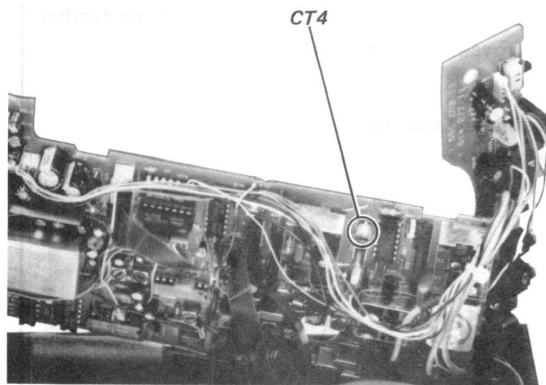

**VCO2 FREERUN FREQUENCY ADJUSTMENT**

**Setup:**

Band: AM

Remove shield plate (N) and install adjustment jumper wire between 3V B+ and the gate of Q31, and then re-install shield plate (N).

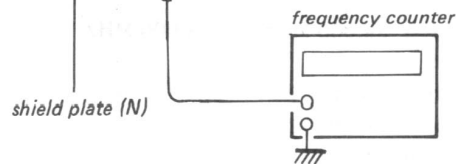
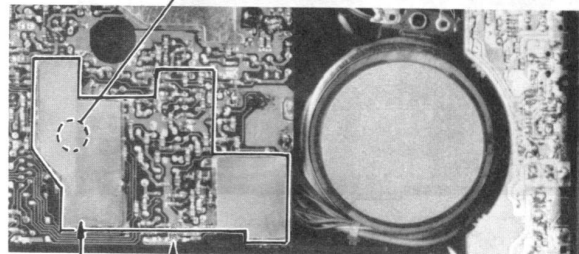
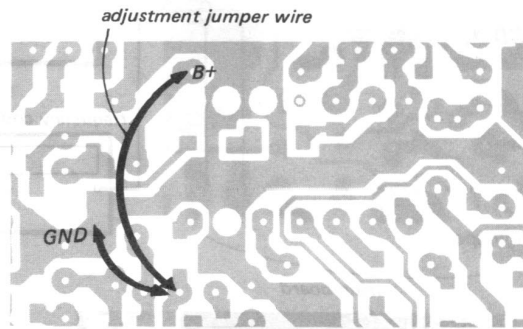

**Procedure:**

1. Adjust CT7 for a 54.000 MHz or 54.0 MHz  $\pm$  300 kHz reading.
2. Unsolder adjustment jumper wire at B+ land side. Connect this end to ground land. Counter reading should now be less than 46.2 MHz.
3. After the adjustment, remove the adjustment jumper wire and properly re-install shield plate (N).

**Adjustment Location:**

— main board —

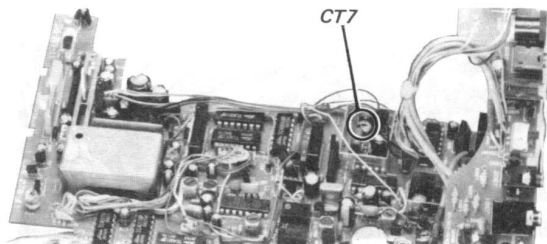

**VCO1 FREQUENCY AND TRACKING ADJUSTMENTS**

**Setup:**

Band: AM  
 Mode: any  
 Frequency: 1,450 kHz

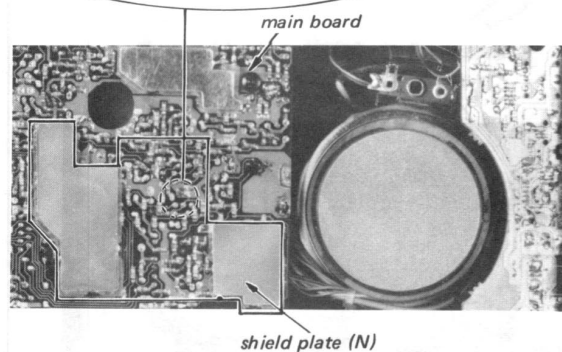
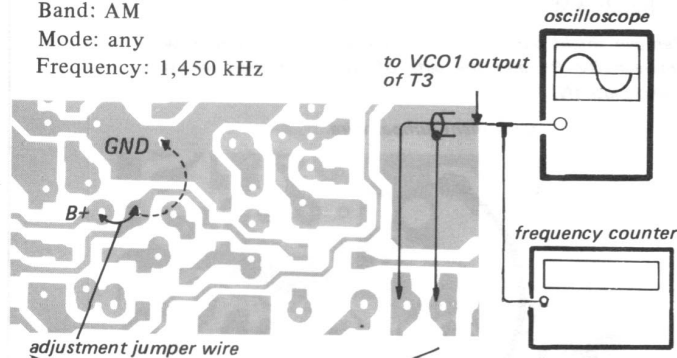

**Procedure:**

1. Adjust CT5 for a 88.000 MHz or 88.000 MHz  $\pm$  300 kHz counter reading.
2. With the adjustment jumper wire connected as is, adjust CT6 for a maximum output level.
3. Unsolder the ground side of the jumper wire set up for adjustments. Connect this end to B+ 3V land. Frequency reading should now be between 50 MHz and 55 MHz.
4. Unsolder the B+ side of the adjustment jumper wire and connect this end to the ground again.
5. Adjust T3 for a maximum output level.
6. Repeat steps 3 through 5 several times until no further improvement is obtained.
7. After the adjustment, remove the adjustment jumper wire and properly install shield plate (N).

**Adjustment Location:**

— main board —

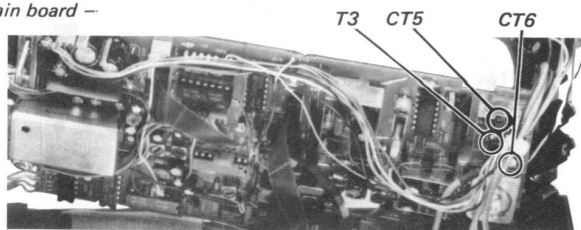

**AM 1st I-F ALIGNMENT**

**Setup:**

Band: AM  
 Mode: WIDE  
 Frequency: any  
 AM RF GAIN control: MAX  
 VOLUME control: as required

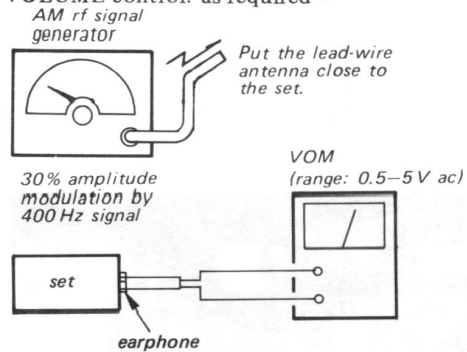

**Procedure:**

1. Tune in the set to the AM RF SSG frequency.
2. Adjust L5 for a maximum output level.
3. Adjust IFT A1 and L6 alternately for a maximum and symmetrical output level.
4. Final response should be as illustrated below.

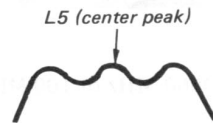

This response can be checked by detuning the set to upper and lower sides of the center frequency in same amount, or by changing SSG frequency with set's frequency unchanged.

5. Repeat above steps several times until no further improvement is obtained.

**Adjustment Location**

— main board —

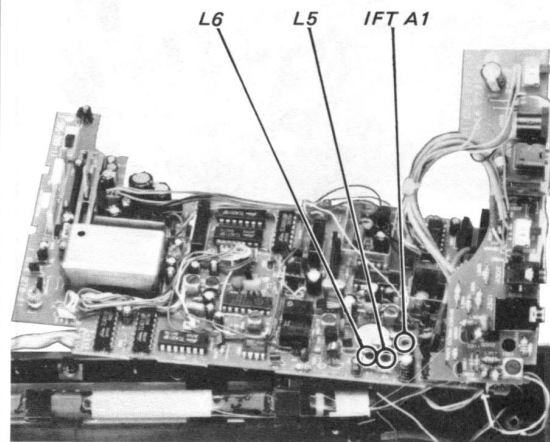



**AM/AIR 455kHz I-F ALIGNMENT**

**Note:** AIR band is not provided for sets to the Middle Easts, Saudi Arabia, UK, Denmark, Finland, Norway and the Federal Republic of Germany.

**Setup:**

Band: AM  
 Mode: WIDE  
 AM RF GAIN control: MAX  
 VOLUME control: as required

**Procedure:**

1. Tune in the set to a known, stable and strong AM station.
2. Adjust IFT A2, IFT A3 and IFT A4 for a maximum output level.

**Adjustment Location**

– main board –

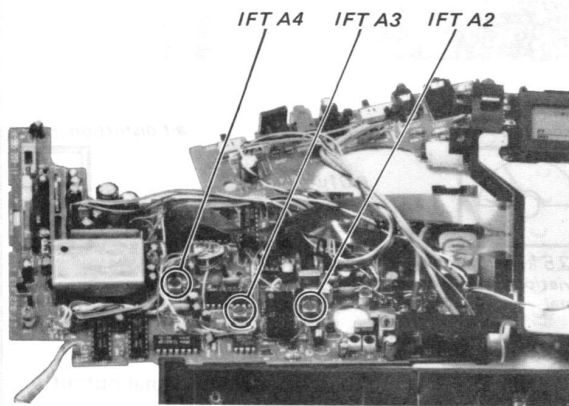

**AM/AIR 2nd LOCAL OSC FREQUENCY CHECK**

**Note:** AIR band is not provided for sets to the Middle Easts, Saudi Arabia, UK, Denmark, Finland, Norway and the Federal Republic of Germany.

**Setup:**

Band: AM or AIR  
 Mode: any  
 AM RF GAIN control: MAX  
 Frequency: any

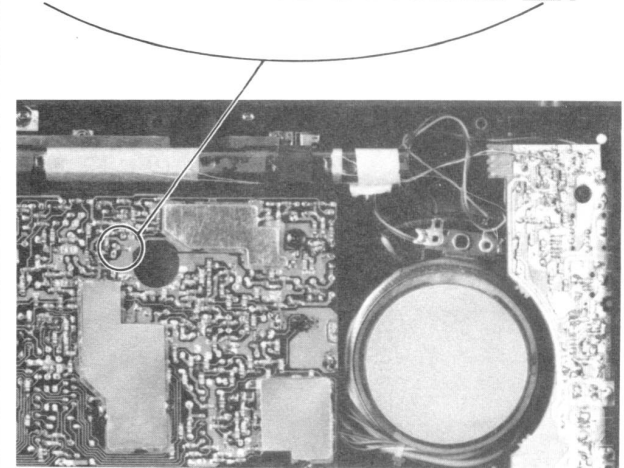
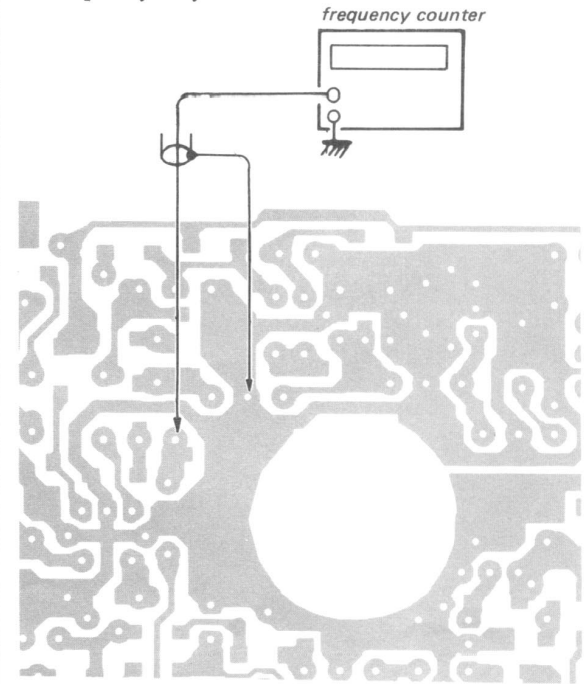

**Procedure:**

Frequency counter should read 55.390 MHz  $\pm$  1 kHz.



**FM I-F ALIGNMENT**

**Setup:**

Band switch: FM

Frequency: clear spot

VOLUME control: as desired

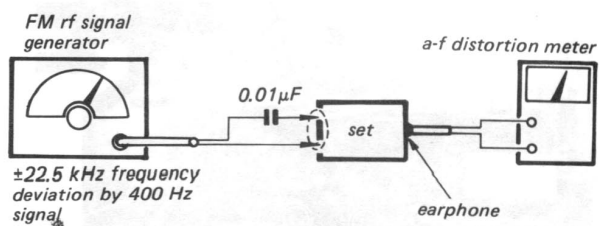
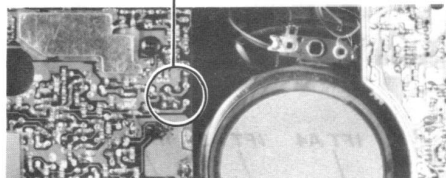
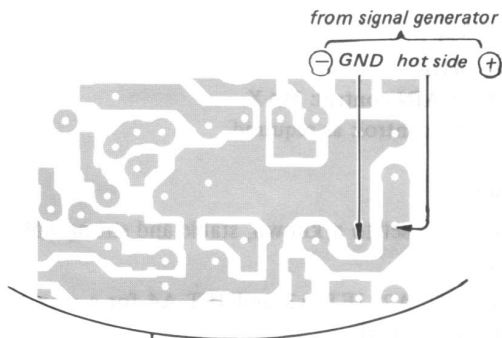

**Procedure:**

1. Adjust IFT F1 to obtain a maximum signal output with the distortion meter set to level mode.
2. Set the mode of distortion meter to distortion.
3. Adjust L9 to obtain a minimum distortion at the modulating signal 400Hz of the FM RF SSG.
4. Repeat above steps to ensure alignment.

**Adjustment Location:**

— main board —

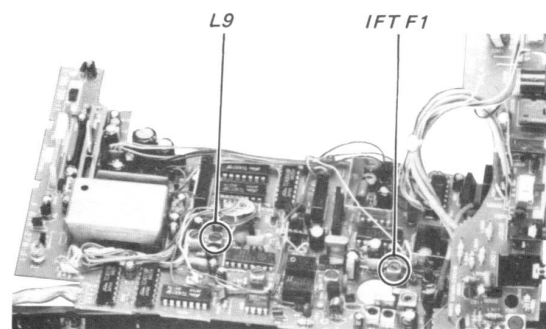

**FM TRACKING ADJUSTMENT**

**Setup:**

Band switch: FM  
 Frequency: as required  
 VOLUME control: as required

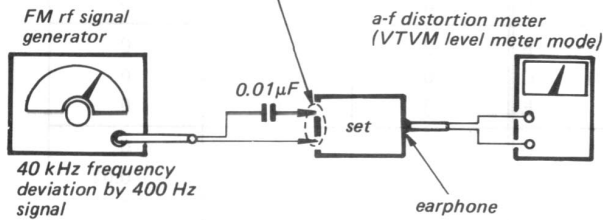
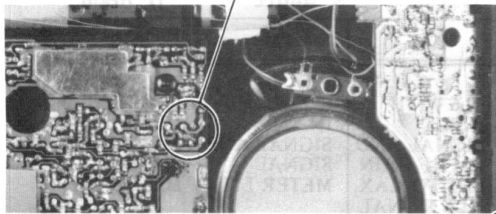
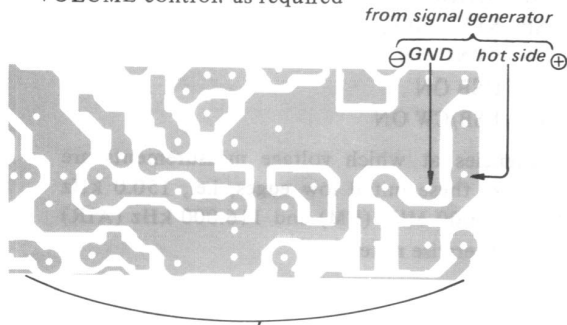

**Procedure:**

1. RF SSG's and Set's Frequency: 80.000 MHz  
Adjust T2 and L11 for a maximum output level.
2. RF SSG's and Set's Frequency: 106.000 MHz  
Adjust CT2 and CT3 for a maximum output level.
3. Repeat above steps several times ending with trimmers until no further improvement is obtained.

**Adjustment Location:**

— main board —

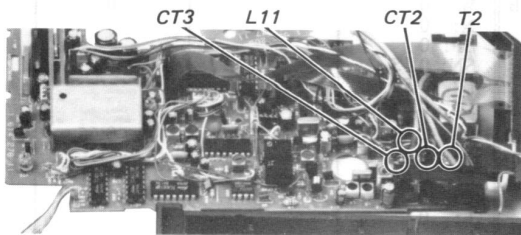

**AIR TRACKING ADJUSTMENT**

**Note:** AIR band is not provided for sets to the Middle Easts, Saudi Arabia, UK, Denmark, Finland, Norway and the Federal Republic of Germany.

**Setup:**

Band switch: AIR  
 Frequency: as required  
 VOLUME control: as required

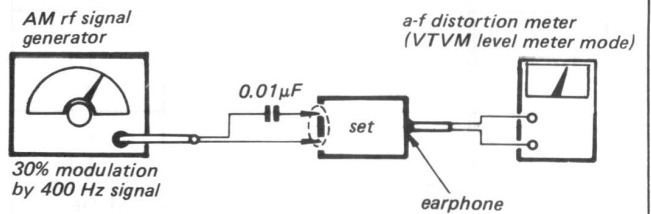
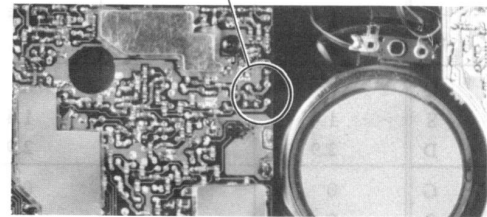
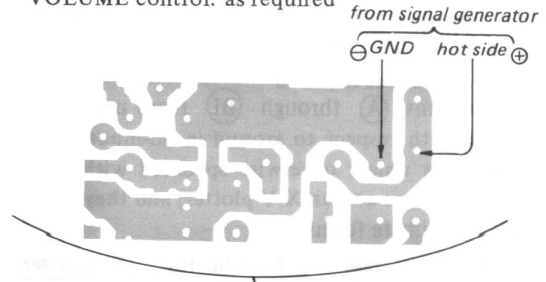

**Procedure:**

1. RF SSG's and Set's Frequency: 116.000 MHz  
Adjust L10 for a maximum output level.
2. RF SSG's and Set's Frequency: 136.000 MHz  
Adjust CT1 for a maximum output level.
3. Repeat above steps several times ending with CT1 until no further improvement is obtained.

**Adjustment Location**

— main board —

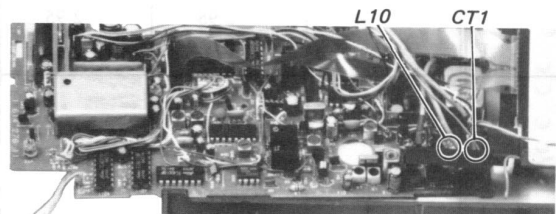

## 3-2. VOLTAGE DISTRIBUTION TABLE

### Note:

1. Voltages are dc with respect to ground under no-input-signal conditions unless otherwise specified with a VOM (50 k $\Omega$ /V).
2. Positions of controls and switches are as follows unless otherwise specified.  
 MAIN POWER switch: ON  
 POWER switch: ON  
 AM ATT switch: DX  
 MANUAL TUNE MODE: as required  
 TONE control: HIGH  
 VOLUME control: MIN  
 All key switches: as required
3. Sample waveforms (A) through (BI) from page 53 are taken with respect to ground in no-input-signal conditions unless otherwise specified with a storage oscilloscope and an X-Y plotter, and they represent approximate forms.

4. Voltage variations may be noted due to production tolerances,  $\pm 10\%$ .
5. Abbreviations for AM band:  
 W: WIDE ON  
 N: NARROW ON  
 SF: SYNC OFF  
 SN: SYNC ON  
 U: USB ON  
 L: LSB/CW ON
6. Frequencies at which voltage measurements are made are these initial low edges, i.e., 150.0 kHz (AM), 76.000 MHz (FM) and 116.000 kHz (AIR) unless otherwise noted.

| Unit: V DC |   | B: base                                      | C: collector | E: emitter                                   |
|------------|---|--|--------------|--|
| Q          |   | AM   | FM           | AIR  |
| Q1         | G | 0  | 0            | 0  |
|            | S | 1.4  | 0            | 1.4  |
|            | D | 2.9  | 0            | 2.9  |
| Q2         | G | 0  | 0            | 0  |
|            | S | 1.4  | 0            | 1.4  |
|            | D | 2.9  | 0            | 2.9  |
| Q3         | G | 0  | 0            | 0  |
|            | S | 0  | 0            | 0  |
|            | D | 2.8  | 0            | 2.8  |
| Q4         | B | 0  | 0            | 0  |
|            | C | 1.9  | 0            | 1.9  |
|            | E | 0  | 0            | 0  |
| Q5         | G | 0  | 0            | 0  |
|            | S | 1.3<br>(250mVp-p<br>SINE OF<br>55,390.0 kHz) | 0            | 1.3<br>(250mVp-p<br>SINE OF<br>55,390.0 kHz) |
|            | D | 2.5  | 0            | 2.5  |
| Q6         | B | W: 0.6<br>N: 0<br>U: 0<br>L: 0               | 0            | 0  |
|            | C | W: 0.1<br>N: 1.75<br>U: 1.75<br>L: 1.75      | 0            | 0  |
|            | E | 0  | 0            | 0  |
| Q8         | B | 0  | 0            | 0  |
|            | C | 2.95   | 2.95         | 2.95   |
|            | E | 0  | 0            | 0  |
|            |   |  |              |  |

|     |   | G: gate   | S: source   | D: drain  |
|-----|---|---|---|---|
| Q   |   | AM  | FM  | AIR   |
| Q9  | B | 0.1<br>(0.6 WITH<br>INPUT<br>SIGNAL AND<br>AM RF GAIN<br>SET TO MAX,<br>ALL SIGNAL<br>METER LED<br>LIT) | 0.1<br>(0.6 WITH<br>INPUT<br>SIGNAL AND<br>SIGNAL<br>METER LIT) | 0.1<br>(0.6 WITH<br>INPUT<br>SIGNAL AND<br>SIGNAL<br>METER LIT) |
|     | C | 1.8   | 1.8   | 1.8   |
|     | E | 0   | 0   | 0   |
| Q10 | B | 0   | 0   | 0   |
|     | C | 0   | 0   | 0   |
|     | E | 0   | 0   | 0   |
| Q11 | G | 0   | 0   | 0   |
|     | S | 0   | 0   | 0.02  |
|     | D | 0   | 0   | 2.9   |
| Q12 | G | 0   | 0   | 0   |
|     | S | 0   | 0   | 0   |
|     | D | 0   | 2.8   | 0   |
| Q13 | B | 0   | 0.65  | 0   |
|     | C | 0   | 1.45  | 0   |
|     | E | 0   | 0   | 0   |
| Q14 | B | 0   | 0.7   | 0   |
|     | C | 0   | 1.9   | 0   |
|     | E | 0   | 0   | 0   |
| Q15 | B | W: 0<br>N: 0<br>SF: 0<br>SN: 0.15<br>U: 0.55<br>L: 0.55   | 0.15  | 0   |
|     | C | W: 0.65<br>N: 0.65<br>SF: 0.65<br>U: 0<br>L: 0  | 0.65  | 0.65  |
|     | E | 0   | 0   | 0   |

AM MODE: W: WIDE ON, N: NARROW ON, SF: SYNC OFF, SN: SYNC ON, U: USB ON, L: LSB/CW ON

| Q   | AM  | FM   | AIR  |
|-----|---|------|------|
| Q16 | B<br>W: 0<br>N: 0<br>SF: 0<br>SN: 0<br>U: 0.6<br>L: 0.6           | 0    | 0    |
|     | C<br>W: 2.05<br>N: 2.05<br>SF: 2.05<br>SN: 2.05<br>U: 0<br>L: 0   | 2.05 | 2.05 |
|     | E<br>0  | 0    | 0    |
| Q17 | B<br>W: 2.4<br>N: 2.4<br>SF: 2.4<br>SN: 2.4<br>U: 2.35<br>L: 2.35 | 2.4  | 2.35 |
|     | C<br>2.95   | 2.95 | 2.95 |
|     | E<br>3.0  | 3.0  | 3.0  |
| Q18 | B<br>0.6  | 0.6  | 0.6  |
|     | C<br>1.0  | 1.0  | 1.0  |
|     | E<br>0  | 0    | 0    |
| Q19 | B<br>W: 0<br>N: 1.1<br>U: 1.1<br>L: 1.1                           | 0    | 0    |
|     | C<br>3  | 3    | 3    |
|     | E<br>W: 1.45<br>N: 1.95<br>U: 1.95<br>L: 1.95                     | 0    | 1.45 |
| Q20 | B<br>W: 0.7<br>N: 0<br>U: 0<br>L: 0                               | 0    | 0.7  |
|     | C<br>3.0  | 3.0  | 3.0  |
|     | E<br>W: 1.45<br>N: 1.95<br>U: 1.95<br>L: 1.95                     | 0    | 1.45 |
| Q21 | B<br>0  | 0    | 0    |
|     | C<br>0  | 0    | 0    |
|     | E<br>0  | 0    | 0    |
| Q22 | G<br>1.0  | 1.0  | 1.0  |
|     | D<br>2.8  | 2.8  | 2.8  |
|     | S<br>1.3  | 1.3  | 1.3  |
| Q23 | B<br>1.2  | 1.2  | 1.2  |
|     | C<br>1.2  | 1.35 | 2.15 |
|     | E<br>0.55   | 0.55 | 0.55 |
| Q24 | G<br>2.0  | 2.15 | 2.9  |
|     | S<br>2.25   | 2.4  | 3.2  |
|     | D<br>12.6   | 12.6 | 12.6 |
| Q25 | B<br>0  | 0    | 0    |
|     | C<br>0.62   | 0.62 | 0.62 |
|     | E<br>0  | 0    | 0    |

| Q   | AM   | FM                      | AIR  |
|-----|--|-------------------------|--|
| Q26 | G<br>0   | 0.2                     | 0  |
|     | S<br>0   | NOT MEASURABLE WITH VOM | 0  |
|     | D<br>0   | 2.8                     | 0  |
| Q27 | B<br>2.15  | 2.8                     | 2.15   |
|     | C<br>2.75  | 0                       | 2.75   |
|     | E<br>2.8   | 2.8                     | 2.8  |
| Q28 | G<br>0   | 0                       | 0  |
|     | S<br>0.3   | 0                       | 0.3  |
|     | D<br>2.3<br>(AT 150 kHz:<br>3Vp-p SINE<br>OF 57,279.0<br>kHz.<br>AT 29,999.9<br>kHz:<br>580mVp-p<br>SINE OF<br>85,845.6 kHz) | 0                       | 2.3<br>(AT 116 MHz<br>3Vp-p SINE<br>OF 60,155.7<br>kHz.<br>AT 136 MHz<br>1Vp-p SINE<br>OF 80,155.7<br>kHz)       |
| Q29 | B<br>0.7   | 0                       | 0.7  |
|     | C<br>2.1<br>(AT 150 kHz<br>720mVp-p<br>SINE OF<br>57,279 kHz.<br>AT 29,999.9<br>kHz<br>510mVp-p<br>SINE OF<br>85,845.6 kHz)  | 0                       | 2.1<br>(AT 116 MHz<br>640mVp-p<br>SINE OF<br>60,155.7 kHz.<br>AT 136 MHz<br>530mVp-p<br>SINE OF<br>80,155.7 kHz) |
|     | E<br>0   | 0                       | 0  |
| Q30 | B<br>0.7<br>(40mVp-p<br>SINE)  | 0.7                     | 0.7<br>(SINE<br>3mVp-p)  |
|     | C<br>1.0<br>(AT 150 kHz<br>730mVp-p<br>SINE OF<br>5,625.0 kHz.<br>AT 29,999.9<br>kHz<br>220mVp-p<br>SINE OF<br>21,607.0 kHz) | 0                       | 1.0<br>(AT 116 MHz<br>300mVp-p<br>SINE OF<br>11,490.0 kHz.<br>AT 136 MHz<br>220mVp-p<br>SINE OF<br>17,659.0 kHz) |
|     | E<br>0   | 0                       | 0  |
| Q31 | G<br>1.3<br>(AT 150 kHz<br>120mVp-p OF<br>50,370.6 kHz)  | 0                       | 1.25<br>(AT 116 MHz<br>130mVp-p OF<br>46,596.0 kHz)  |
|     | S<br>1.45  | 0                       | 1.45   |
|     | D<br>2.6   | 0                       | 2.6  |

AM MODE: W: WIDE ON, N: NARROW ON, SF: SYNC OFF, SN: SYNC ON, U: USB ON, L: LSB/CW ON

| Q   | AM   | FM              |  |
|-----|--|-----------------|--|
| Q32 | B 0.6  | 0               | 0.6  |
|     | C 0.7<br>(AT 150 kHz<br>420mVp-p<br>SINE OF<br>50,370.661<br>kHz.<br>AT 29,999.9<br>kHz<br>420mVp-p<br>SINE OF<br>50,345.561<br>kHz) | 0               | 1.5<br>(AT 116-136<br>MHz<br>380mVp-p<br>SINE OF<br>46,605.653<br>kHz) |
|     | E 0  | 0               | 0  |
| Q33 | G 0  | 0               | 0  |
|     | S 0.2  | 0               | 0.2  |
|     | D 2.6  | 0               | 2.6  |
| Q34 | B 0.7  | 0               | 0.7  |
|     | C 1.3  | 0               | 1.3  |
|     | E 0<br>(FIXED<br>55,390.0 kHz<br>SINE OF<br>240mVp-p)  | (SAME AS<br>AM) | (SAME AS<br>AM)  |
| Q35 | B 2.4  | 2.4             | 2.4  |
|     | C 0  | 2.9             | 0  |
|     | E 3.0  | 3.0             | 3.0  |
| Q36 | B 0.35   | 1.4             | 0.35   |
|     | C 2.3  | 0               | 2.3  |
|     | E 0  | 0               | 0  |
| Q37 | B 2.4  | 2.4             | 2.4  |
|     | C 0  | 0               | 3.0  |
|     | E 3.0  | 3.0             | 3.0  |
| Q38 | B 0  | 0               | 2.9  |
|     | C 2.4  | 2.4             | 0  |
|     | E 0  | 0               | 0  |
| Q39 | B 2.3  | 3.0             | 2.3  |
|     | C 2.9  | 0               | 2.9  |
|     | E 3.0  | 3.0             | 3.0  |
| Q40 | B 3.8  | 3.8             | 3.8  |
|     | C 4.4  | 4.4             | 4.4  |
|     | E 4.5  | 4.5             | 4.5  |
| Q41 | B 3.8  | 3.8             | 3.8  |
|     | C 4.4  | 4.4             | 4.4  |
|     | E 4.5  | 4.5             | 4.5  |
| Q42 | B 0.65   | 0.65            | 0.65   |
|     | C 0.05   | 0.05            | 0.05   |
|     | E 0  | 0               | 0  |
| Q43 | B 0.62   | 0.62            | 0.62   |
|     | C MOMENTARILY 0.5 WHEN<br>KEYED IN,<br>0 AFTER-<br>WARDS.  | SAME AS<br>AM.  | SAME AS<br>AM.   |
|     | E 0  | 0               | 0  |

| Q    | AM  | FM  | AIR |
|------|---|---|-----|
| Q44  | B W, N, SF:<br>0-2.45<br>CHANGING<br>(NOISE).<br>SN: WITH<br>INPUT<br>SIGNAL AND<br>D411<br>(UPPER) LIT:<br>0V<br>D412<br>(LOWER) LIT<br>2.45 V | 0 OR 2.45<br>DEPENDING<br>UPON<br>TIMING OF<br>KEYING IN. | 0   |
|      | C W, N, SF:<br>0-2.45<br>CHANGING<br>(NOISE).<br>SN: WITH<br>INPUT<br>SIGNAL AND<br>D411<br>(UPPER) LIT:<br>2.45,<br>D412<br>(LOWER) LIT:<br>0V | 2.45 OR 0<br>DEPENDING<br>UPON<br>TIMING OF<br>KEYING IN. | 0   |
| Q45  | E 0   | 0   | 0   |
|      | B 0   | 0   | 0   |
|      | C 1.8   | 0   | 1.8 |
| Q46  | E 0   | 0   | 0   |
|      | B 3.7   | 3.7   | 3.7 |
|      | C 2.8   | 2.8   | 2.8 |
| Q47  | E 4.4   | 4.4   | 4.4 |
|      | B 0.6   | 0.6   | 0.6 |
|      | C 0.6   | 0.6   | 0.6 |
| Q48  | E 0   | 0   | 0   |
|      | B 0.6   | 0.6   | 0.6 |
|      | C 3.4   | 3.6   | 3.4 |
| Q301 | E 0   | 0   | 0   |
|      | B 0   | 0   | 0   |
|      | C 2.0   | 0   | 0   |
| Q302 | E 0   | 0   | 0   |
|      | G 0   | 0   | 0   |
|      | S 0.1   | 0   | 0   |
| Q303 | D 2.9   | 0   | 0   |
|      | G 0   | 0   | 0   |
|      | S 0.2   | 0   | 0   |
| Q304 | D 2.9   | 0   | 0   |
|      | B 2.2   | 2.3   | 0   |
|      | C 2.9   | 0   | 0   |
| Q305 | E 2.9   | 0   | 2.9 |
|      | B 0   | 0.55  | 0.6 |
|      | C 0.65  | 0   | 0   |
| Q306 | E 0   | 0   | 0   |
|      | B 0   | 0   | 2.2 |
|      | C 0.65  | 0   | 0   |
| Q306 | E 0   | 0   | 0   |

| Q    |   | AM   | FM                      | AIR                     |
|------|---|--|-------------------------|-------------------------|
| Q401 | B | 2.1  | 2.1                     | 2.1                     |
|      | C | W: 0<br>N: 0<br>SF: SYNC<br>LED OFF;<br>2.9<br>SYNC LED<br>ON WITH<br>INPUT<br>SIGNAL:<br>2.75 | 0                       | 0                       |
|      | E | 2.95   | 2.95                    | 2.95                    |
| Q501 | B | D501 (LIGHT)<br>OFF: 0<br>ON: 0.75   | SAME AS<br>AM           | SAME AS<br>AM           |
|      | C | D501 (LIGHT)<br>OFF: 2.75<br>ON: 0.15  |                         |                         |
|      | E | 0  | 0                       | 0                       |
| Q502 | B | 2.35   | 2.35                    | 2.35                    |
|      | C | 0  | 0                       | 0                       |
|      | E | 2.95   | 2.95                    | 2.95                    |
| Q504 | B | 0  | 0                       | 0                       |
|      | C | 1.8  | 1.8                     | 1.8                     |
|      | E | 0  | 0                       | 0                       |
| Q601 | B | W: 0<br>N: 0<br>U: 2.85<br>L: 2.85   | 0                       | 0                       |
|      | C | U: 0<br>L: 0   | 0                       | 0                       |
|      | E | 0  | 0                       | 0                       |
| Q602 | B | 0  | 0                       | 2.9                     |
|      | C | SN, U, L: 1.8<br>W, N, SF: 0   | 1.8                     | 0                       |
|      | E | 0  | 0                       | 0                       |
| Q603 | B | 0.95<br>(1.3Vp-p SINE<br>OF 3.64 MHz)  | 0.95<br>(SAME AS<br>AM) | 0.95<br>(SAME AS<br>AM) |
|      | C | 2.7  | 2.7                     | 2.7                     |
|      | E | 0.9  | 0.9                     | 0.9                     |
| Q701 | B | 0  | 0                       | 0                       |
|      | C | 0.6  | 0.6                     | 0.6                     |
|      | E | 0  | 0                       | 0                       |
| Q702 | B | 0.6  | 0.6                     | 0.6                     |
|      | C | 6.0  | 6.0                     | 6.0                     |
|      | E | 0  | 0                       | 0                       |

| IC  | PIN   | AM   | FM                   | AIR                  |  |
|-----|---|--|----------------------|----------------------|--|
| IC1 | 1   | NOT USED.  | NOT USED.            | NOT USED.            |  |
|     | 2   | 0  | 0.7                  | 0                    |  |
|     | 3   | 0  | 0                    | 0                    |  |
|     | 4   | 0  | 1.2                  | 0                    |  |
|     | 5   | 0  | 1.7                  | 0                    |  |
|     | 6   | 0.1  | 2.8                  | 0.1                  |  |
|     | 7   | 2.8  | 2.8                  | 2.8                  |  |
|     | 8   | 0  | 1.7                  | 0                    |  |
|     | 9   | 0  | 0                    | 0                    |  |
|     | 10  | 0.7  | 1.1                  | 0.7                  |  |
|     | 11  | 0.65   | 0.55                 | 0.65                 |  |
|     | 12  | 2.7  | 0                    | 2.7                  |  |
|     | 13  | 0.6  | 0.6                  | 0.6                  |  |
|     | 14  | 0.05   | 0.05                 | 0.05                 |  |
|     | (1.1 WITH AM RF GAIN MAX AND ALL SIGNAL METER LEDS LIT) |  |                      |                      |  |
|     | 15  | 2.7  | 0                    | 2.7                  |  |
| 16  | 0.6   | 0.55   | 0.6                  |                      |  |
| IC2 | 1   | 0  | 0                    | 0                    |  |
|     | 2   | 1.35   | 1.35                 | 1.35                 |  |
|     | 3   | 0.5<br>(3V RANGE)  | 0.5<br>(3V RANGE)    | 0.5<br>(3V RANGE)    |  |
|     | 4   | 0  | 0                    | 0                    |  |
|     | 5   | 0.55   | 0.55                 | 0.55                 |  |
|     | 6   | 0.5<br>(3V RANGE)  | 0.5<br>(3V RANGE)    | 0.5<br>(3V RANGE)    |  |
|     | 7   | 0  | 0                    | 0                    |  |
|     | 8   | 3.0  | 3.0                  | 3.0                  |  |
| IC3 | 1   | W, N, SF:<br>0-2.45<br>CHANGING<br>WITH NOISE<br>INPUT.<br>SN, U, L:<br>0 OR 2.45<br>DEPENDING<br>UPON<br>TIMING OF<br>KEYING IN<br>(MORE "L"<br>OR MORE<br>"H") | 0 OR 2.45            | 0                    |  |
|     | 2   | W, N: 0.85<br>SN: 0.55<br>U, L: 0.35   | 0.55                 | 1.0                  |  |
|     | 3   | 1.4  | 1.45                 | 1.4                  |  |
|     | 4   | 0  | 0                    | 0                    |  |
|     | 5   | 1.45   | 1.45                 | 1.45                 |  |
|     | 6   | W, N, SF, SN:<br>0.65<br>U, L: 0   | 0.65                 | 0.65                 |  |
|     | 7   | W, N: 1.7<br>SN: 1.1<br>U, L: 2.55<br>MEMORY<br>ON: 0<br>MEMORY<br>ON:<br>MOMENTARI-<br>LY 1.1   | MOMENTARI-<br>LY 1.6 | MOMENTARI-<br>LY 1.6 |  |
|     | 8   | 3.0  | 3.0                  | 3.0                  |  |

| IC  | PIN | AM   | FM   | AIR  |
|-----|-----|--|--|--|
| IC4 | 1   | -0.75<br>(3V RANGE)  | -0.75<br>(3V RANGE)                          | -0.75<br>(3V RANGE)  |
|     | 2   | 2.95   | 2.95   | 2.95   |
|     | 3   | 0  | 0  | 0  |
|     | 4   | 0  | 0  | 0  |
|     |     | (SAME AS PIN11 OF IC506)   | (SAME AS PIN11 OF IC506)                     | (SAME AS PIN11 OF IC506)   |
|     | 5   | SINE<br>1.3Vp-p<br>(NOT MEASURABLE WITH VOM)   | SINE<br>1.3Vp-p<br>(NOT MEASURABLE WITH VOM) | SINE<br>1.3Vp-p<br>(NOT MEASURABLE WITH VOM)                                 |
|     | 6   | 1.3<br>(SINE<br>2.15Vp-p)  | 1.3<br>(SINE<br>2.15Vp-p)                    | 1.3<br>(SINE<br>2.15Vp-p)  |
|     | 7   | 1.0  | 1.0  | 1.0  |
|     | 8   | 0  | 0  | 0  |
|     | 9   | NOT USED.  | NOT USED.                                    | NOT USED.  |
|     | 10  | 0.1  | 0.25   | 0.1  |
|     | 11  | 0.25   | 0.15   | 0.25   |
|     | 12  | 2.6  | 2.6  | 2.6  |
|     | 13  | NOT USED.  | NOT USED.                                    | NOT USED.  |
| 14  | 0   | 0  | 0  |  |
| IC5 | 1   | 2.75   | 0  | 2.75   |
|     | 2   | 2.55<br>(AT 150 kHz<br>60mVp-p<br>SIGNAL)  | 0  | 2.55<br>(AT 116 MHz<br>40mVp-p<br>SIGNAL)                                    |
|     | 3   | 2.0  | 0  | 2.0  |
|     | 4   | 0  | 0  | 0  |
|     | 5   | 1.15<br>(AT 150 kHz<br>280mVp-p<br>SINE.<br>AT 29,999.9<br>kHz<br>320mVp-p<br>SINE.) | 0  | 1.15<br>(AT 116 MHz<br>280mVp-p<br>SINE.<br>AT 136 MHz<br>320mVp-p<br>SINE.) |
|     | 6   | 1.15   | 0  | 1.15   |
|     | 7   | 1.1<br>(AT 150 kHz,<br>70mVp-p<br>SINE.<br>AT 29,999.9<br>kHz, 80mVp-p<br>SINE)      | 0  | 1.1<br>(AT 116 MHz,<br>55mVp-p<br>SINE.<br>AT 136 MHz,<br>70mVp-p SINE)      |

| IC  | PIN | AM   | FM  | AIR  |
|-----|-----|--|-----|--|
| IC6 | 1   | -0.7   | 0   | 0.7  |
|     | 2   | 2.95   | 0   | 2.95   |
|     | 3   | 0  | 0   | 0  |
|     | 4   | 0  | 0   | 0  |
|     | 5   | 1.3<br>(800mVp-p<br>SINE<br>SIGNAL)  | 0   | 1.3<br>(800mVp-p<br>SINE<br>SIGNAL)  |
|     | 6   | 1.1<br>(2Vp-p SINE)  | 0   | 1.1<br>(2Vp-p SINE)  |
|     | 7   | 1.3<br>(65mVp-p<br>SAWTOOTH)   | 0   | 1.25<br>(65mVp-p<br>SAWTOOTH)  |
|     | 8   | 0  | 0   | 0  |
|     | 9   | 0  | 0   | 0  |
|     | 10  | 0.1  | 0   | 0.1  |
|     | 11  | 0.25   | 0   | 0.25   |
|     | 12  | 2.75   | 0   | 2.75   |
|     | 13  | 0.25<br>(AT 150 kHz,<br>170mVp-p<br>SINE SIGNAL<br>OF 5020 kHz.<br>AT 29,999.9<br>kHz,<br>190mVp-p<br>SINE SIGNAL<br>OF 5271 kHz.) | 0   | 0.25<br>(AT 116 MHz,<br>190mVp-p<br>SINE SIGNAL<br>OF 8785 kHz.<br>AT 136 MHz,<br>210mVp-p<br>SINE SIGNAL<br>OF 8785 kHz.) |
|     | 14  | 0  | 0   | 0  |
| IC7 | 1   | 2.7  | 0   | 2.7  |
|     | 2   | 2.5<br>(150mVp-p<br>SIGNAL)  | 0   | 2.5<br>(55mVp-p<br>SIGNAL)   |
|     | 3   | 1.95   | 0   | 1.95   |
|     | 4   | 0  | 0   | 0  |
|     | 5   | 1.1<br>(AT 150 kHz,<br>560mVp-p<br>SINE OF<br>50,370.6 kHz.<br>AT 29,999.9<br>kHz,<br>560mVp-p<br>SINE OF<br>50,345.5 kHz.)        | 0   | 1.1<br>(CONSTANT<br>410mVp-p<br>SINE SIGNAL<br>OF 46,605.66<br>kHz.)   |
|     | 6   | 1.1  | 0   | 1.1  |
|     | 7   | 1.1<br>(190mVp-p<br>SINE OF<br>55,391.15<br>kHz)   | 0   | 1.1<br>(190mVp-p<br>SINE OF<br>55,391.15<br>kHz)   |
| IC9 | 1   | 4.4  | 4.4 | 4.4  |
|     | 2   | 0  | 0   | 0  |
|     | 3   | 3.0  | 3.0 | 3.0  |

AM MODE: W: WIDE ON, N: NARROW ON, SF: SYNC OFF, SN: SYNC ON, U: USB ON, L: LSB/CW ON

| IC   | PIN  | AM   | FM                          | AIR                         | IC   | PIN  | AM                                       | FM   | AIR  |      |
|------|------|--|-----------------------------|-----------------------------|------|--|--|------|------|------|
| IC10 | 1, 3 | W, N: 1.1<br>SF: 1.55<br>SN: 0.7<br>U, L: 1.4<br>(SF WITH<br>MAX AM RF<br>GAIN AND<br>TUNED IN A<br>STATION,<br>880mVp-p<br>SIGNAL.) | 0.7                         | 1.1                         | IC12 | 1  | 0  | 0    | 0    |      |
|      | 2    | W, N, SN: 0.7<br>U, L: 0.45  | 0.7                         | 1.1                         |      | 2  | 1.8                                      | 1.8  | 1.8  |      |
|      | 4    | 1.5  | 1.5                         | 1.5                         |      | 3  | 0  | 0    | 0    |      |
|      | 5    | W, N, SN: 0<br>U, L: 2.85  | 0                           | 0                           |      | 4  | W, N, SF, U,<br>L: 0<br>SN: 2.95         | 2.95 | 0    |      |
|      | 6    | W, N, SF, U:<br>1.7<br>SN, L: 0  | 0                           | 1.7                         |      | 5  | U, L: 2.85<br>OTHERS: 0                  | 0    | 0    |      |
|      | 7    | 0  | 0                           | 0                           |      | 6  | SN, U, L: 0<br>SF: 2.9                   | 0    | 2.85 |      |
|      | 8-11 | 0.3  | 0.3                         | 0.3                         |      | 7  | 0  | 0    | 0    |      |
|      | 12   | W, N, SF, SN,<br>U: 0<br>L: 1.8  | 1.8                         | 0                           |      | 8  | W, N, SF, U,<br>L: 2.95<br>SN: 0         | 0    | 2.95 |      |
|      | 13   | W, N, SF, SN:<br>2.95<br>U, L: 0   | 2.95                        | 2.95                        |      | 9  | W, N, SF, SN:<br>2.95<br>U, L: 0         | 2.95 | 2.95 |      |
|      | 14   | 3.0  | 3.0                         | 3.0                         |      | 10   | 0  | 0    | 0    |      |
|      | IC11 | 1  | 0                           | 0                           |      | 0  | 11                                       | 2.95 | 2.95 | 2.95 |
|      |      | 2  | 2.95                        | 2.95                        |      | 2.95   | 12                                       | 0    | 0    | 0    |
|      |      | 3  | 0                           | 0                           |      | 0  | 13                                       | 0    | 0    | 0    |
|      |      |  | SAMPLE<br>WAVEFORM:<br>(BH) | SAMPLE<br>WAVEFORM:<br>(BH) |      | SAMPLE<br>WAVEFORM:<br>(BH)                          | 14                                       | 3.0  | 3.0  | 3.0  |
| 4    |      | 2.95   | 2.95                        | 2.95                        | IC13 | 1  | 2.95                                     | 0    | 0    |      |
| 5    |      | 0  | 2.95                        | 2.95                        |      | 2  | 0.35                                     | 1.4  | 0.35 |      |
| 6    |      | 2.95   | 0                           | 0                           |      | 3  | 0  | 0    | 2.9  |      |
| 7    |      | 0  | 0                           | 0                           |      | 4  | 0  | 2.95 | 2.95 |      |
| 8    |      | W, N, SF, U: 0<br>SN, L: 2.95  | 2.95                        | 0                           |      | 5  | LW: 3<br>MW: 0<br>SW: 3                  | 0    | 0    |      |
| 9    |      | W, N, SF, U:<br>2.95<br>SN, L: 0   | 0                           | 2.95                        |      | 6  | LW: 0<br>MW: 3<br>SW: 3                  | 0    | 0    |      |
| 10   |      | W, N, SF, SN:<br>2.95<br>U, L: 0   | 2.95                        | 2.95                        |      | 7  | 0  | 0    | 0    |      |
| 11   |      | W, N, SF, SN:<br>0<br>U, L: 2.85   | 0                           | 0                           |      | 8  | 0.35                                     | 2.9  | 0.35 |      |
| 12   |      | W, N, SF, U: 0<br>SN, L: 2.95  | 0                           | 0                           |      | 9  | 2.95                                     | 0    | 0    |      |
| 13   |      | W, N, SF, U:<br>2.95<br>SN, L: 0   | 0                           | 2.95                        |      | 10   | W: 2.4<br>N, U, L: 0<br>PRIORITY:<br>W/N | 0    | 2.4  |      |
| 14   | 3.0  | 3.0  | 3.0                         | 11                          |      | W, N, SF, U,<br>L: 0<br>SN: 2.95                     | 2.95                                     | 0    |      |      |
|      |      |  |                             | 12                          |      | W, N, SF, SN:<br>0<br>U, L: 2.85<br>PRIORITY:<br>SSB | 0  | 0    |      |      |
|      |      |  |                             | 13                          |      | W, N, SF, U:<br>2.95<br>SN, L: 0                     | 0  | 2.95 |      |      |
|      |      |  |                             | 14                          |      | 3.0  | 3.0                                      | 3.0  |      |      |



AM MODE: W: WIDE ON, N: NARROW ON, SF: SYNC OFF, SN: SYNC ON, U: USB ON, L: LSB/CW ON

| IC    | PIN   | AM  | FM   | AIR   |   |
|-------|-------|---|--|---|---|
| IC14  | 1     | 3.0   | 3.0  | 3.0   |   |
|       | 2     | W, N, SF, U,<br>L: 0<br>SN: 2.95  | 2.95   | 0   |   |
|       | 3     | W, N, SF, U,<br>L: 2.95<br>SN: 0  | 0  | 2.95  |   |
|       | 4, 9  | W, N, SF, SN:<br>2.95<br>U, L: 0  | 2.95   | 2.95  |   |
|       | 5, 11 | 2.95  | 2.95   | 2.95  |   |
|       | 6, 10 | W, N, SF: 0<br>U, L: 2.95   | 0  | 0   |   |
|       | 12    | W, N, SF: 2.9<br>SN, U, L: 0.5  | 0.5  | 2.9   |   |
|       | 13    | WHEN BAND<br>IS CHANGED<br>TO AM, MO-<br>MENTARILY<br>1.7.<br>SN: MOMEN-<br>TARILY 1.1.<br>U, L: 2.55   | WHEN BAND<br>IS CHANGED<br>TO FM, MO-<br>MENTARILY<br>1.6.   | WHEN BAND<br>IS CHANGED<br>TO AIR, MO-<br>MENTARILY<br>1.6. |   |
|       | 14    | 3.0   | 3.0  | 3.0   |   |
|       | IC15  | 1   | WHEN BAND<br>IS CHANGED<br>TO AM, MO-<br>MENTARILY<br>1.7.<br>SN: MOMEN-<br>TARILY 1.1<br>U, L: 2.55 | WHEN BAND<br>IS CHANGED<br>TO FM, MO-<br>MENTARILY<br>1.6.  | WHEN BAND<br>IS CHANGED<br>TO AIR, MO-<br>MENTARILY<br>1.6. |
|       |       | 2, 4  | W, N, SF: 0<br>SN, U, L: 2.95  | 2.95  | 0   |
|       |       | 3   | W, N, SF: 2.95<br>↓<br>U, L: 0   | 2.95  | 2.95  |
|       |       | 5, 6  | W, N, SF: 2.9<br>SN, U, L: 0.5   | 0.5   | 2.9   |
|       |       | 7   | 0  | 0   | 0   |
| 8, 11 |       | 2.95  | 2.95   | 2.95  |   |
| 9, 13 |       | 0   | 0  | 0   |   |
| 10    |       | 2.95  | 2.95   | 2.95  |   |
| 12    |       | W, N, SF:<br>0-2.45<br>CHANGING<br>(NOISE).<br>SN: WITH<br>INPUT<br>SIGNAL AND<br>D411<br>(UPPER) LIT:<br>2.45,<br>D412<br>(LOWER) LIT:<br>0V | 2.45 OR 0<br>DEPENDING<br>UPON<br>TIMING OF<br>KEYING IN.  | 0   |   |
| 14    |       | 3.0   | 3.0  | 3.0   |   |

| IC   | PIN      | AM  | FM  | AIR      |      |
|------|----------|---|---|----------|------|
| IC16 | 1        | W, N, SF:<br>0-2.45<br>CHANGING<br>(NOISE).<br>SN: WITH<br>INPUT<br>SIGNAL AND<br>D411<br>(UPPER) LIT:<br>2.45,<br>D412<br>(LOWER)<br>LIT: 0V | 2.45 OR 0<br>DEPENDING<br>UPON<br>TIMING OF<br>KEYING IN. | 0        |      |
|      | 2        | W, N, SF, U,<br>L: 0<br>SN: 2.95  | 2.95  | 0        |      |
|      | 3, 12    | W, N, SF, U,<br>L: 2.95<br>SN: 0  | 0   | 3.0      |      |
|      | 4        | 0   | 0   | 0        |      |
|      | 5, 6, 10 | 3.0   | 3.0   | 3.0      |      |
|      | 7        | 0   | 0   | 0        |      |
|      | 8        | LW: 0<br>MW: 3<br>SW: 3   | 0   | 0        |      |
|      | 9        | W, N, SF, SN,<br>U: 1.8<br>L: 0   | 0 OR 1.8  | 1.8      |      |
|      | 11       | W, N, SF, U:<br>2.95<br>SN, L: 0  | 0   | 2.95     |      |
|      | 13       | W, N, SF, U: 0<br>SN, L: 2.95   | 2.95  | 0        |      |
|      | 14       | 3.0   | 3.0   | 3.0      |      |
|      | IC17     | 1   | 0.7   | 0.7      | 0.7  |
|      |          | 2   | 0   | 0        | 0    |
|      |          | 3   | 0.55  | 0.55     | 0.55 |
| 4    |          | NOT USED  | NOT USED  | NOT USED |      |
| 5    |          | 0   | 0   | 0        |      |
| 6    |          | 2.25  | 2.25  | 2.25     |      |
| 7    |          | 4.4   | 4.4   | 4.4      |      |
| 8    |          | 4.4   | 4.4   | 4.4      |      |
| 9    |          | 4.4   | 4.4   | 4.4      |      |

FOR SAMPLE WAVEFORMS, SEE PAGES FROM 53.

| IC    | PIN | AM   | FM   | AIR  |
|-------|-----|--|--|--|
| IC401 | 1   | 0  | 0  | 0  |
|       | 2   | 0<br>(0.02 WITH<br>MAX AM RF<br>GAIN)                              | 0  | 0  |
|       | 3   | 0.05   | 0.05   | 0.05   |
|       | 4   | 1.6<br>(1.35 WHEN<br>D405 LIT)                                     | 1.6<br>(1.35 WHEN<br>D405 LIT)                                     | 1.6<br>(1.35 WHEN<br>D405 LIT)                                     |
|       | 5   | 1.6<br>(1.35 WHEN<br>D404 LIT)                                     | 1.6<br>(1.35 WHEN<br>D404 LIT)                                     | 1.6<br>(1.35 WHEN<br>D404 LIT)                                     |
|       | 6   | 1.6<br>(1.35 WHEN<br>D403 LIT)                                     | 1.6<br>(1.35 WHEN<br>D403 LIT)                                     | 1.6<br>(1.35 WHEN<br>D403 LIT)                                     |
|       | 7   | 1.6<br>(1.35 WHEN<br>D402 LIT)                                     | 1.6<br>(1.35 WHEN<br>D402 LIT)                                     | 1.6<br>(1.35 WHEN<br>D402 LIT)                                     |
|       | 8   | 1.6<br>(1.35 WHEN<br>D401 LIT)                                     | 1.6<br>(1.35 WHEN<br>D401 LIT)                                     | 1.6<br>(1.35 WHEN<br>D401 LIT)                                     |
|       | 9   | 1.6<br>(1.35 WHEN<br>D406 LIT)                                     | 1.6<br>(1.35 WHEN<br>D406 LIT)                                     | 1.6<br>(1.35 WHEN<br>D406 LIT)                                     |
|       | 10  | 2.0<br>(1.35 WHEN<br>D407 LIT)                                     | 2.0<br>(1.35 WHEN<br>D407 LIT)                                     | 2.0<br>(1.35 WHEN<br>D407 LIT)                                     |
|       | 11  | 1.6<br>(1.35 WHEN<br>D408 LIT)                                     | 1.6<br>(1.35 WHEN<br>D408 LIT)                                     | 1.6<br>(1.35 WHEN<br>D408 LIT)                                     |
|       | 12  | 1.6<br>(1.35 WHEN<br>D409 LIT)                                     | 1.6<br>(1.35 WHEN<br>D409 LIT)                                     | 1.6<br>(1.35 WHEN<br>D409 LIT)                                     |
|       | 13  | 1.6<br>(1.35 WHEN<br>D410 LIT)                                     | 1.6<br>(1.35 WHEN<br>D410 LIT)                                     | 1.6<br>(1.35 WHEN<br>D410 LIT)                                     |
|       | 14  | 1.25   | 1.25   | 1.25   |
|       | 15  | 2.95   | 2.95   | 2.95   |
|       | 16  | 1.2  | 1.2  | 1.2  |
| IC501 | 1   | 0  | 0  | 0  |
|       | 2   | 2.95<br>(WAVEFORM<br>H)  | 2.95<br>(WAVEFORM<br>H)  | 2.95<br>(WAVEFORM<br>H)  |
|       | 3   | 2.95<br>(WAVEFORM<br>I)  | 2.95<br>(WAVEFORM<br>I)  | 2.95<br>(WAVEFORM<br>I)  |
|       | 4   | 2.95<br>(WAVEFORM<br>J)  | 2.95<br>(WAVEFORM<br>J)  | 2.95<br>(WAVEFORM<br>J)  |
|       | 5   | 0<br>(0.2 DURING<br>TURNING<br>TUNING<br>KNOB)                     | 0<br>(0.2 DURING<br>TURNING<br>TUNING<br>KNOB)                     | 0<br>(0.2 DURING<br>TURNING<br>TUNING<br>KNOB)                     |
|       | 6   | 0  | 0  | 0  |
|       | 7   | 0.4<br>(0.55 DUR-<br>ING TURN-<br>ING TUNING<br>KNOB)              | 0.4<br>(0.55 DUR-<br>ING TURN-<br>ING TUNING<br>KNOB)              | 0.4<br>(0.55 DUR-<br>ING TURN-<br>ING TUNING<br>KNOB)              |
|       | 8   | 2.95<br>(0 WHEN<br>POWER<br>SWITCH S502<br>SET TO OFF<br>OR TIMER) | 2.95<br>(0 WHEN<br>POWER<br>SWITCH S502<br>SET TO OFF<br>OR TIMER) | 2.95<br>(0 WHEN<br>POWER<br>SWITCH S502<br>SET TO OFF<br>OR TIMER) |

| IC    | PIN | AM   | FM                   | AIR                  |
|-------|-----|--|----------------------|----------------------|
| IC501 | 9   | 0<br>(ALSO 0<br>WHEN<br>POWER<br>SWITCH S502<br>SET TO OFF.<br>2.95 WHEN<br>POWER<br>SWITCH S502<br>SET TO<br>TIMER)   | 0<br>(SAME AS<br>AM) | 0<br>(SAME AS<br>AM) |
|       | 10  | 0<br>(CHANGING<br>ABOUT 2.75<br>DURING<br>TURNING<br>TUNING<br>KNOB)   | 0<br>(SAME AS<br>AM) | 0<br>(SAME AS<br>AM) |
|       | 11  | 0  | 0                    | 0                    |
|       | 12  | 0<br>(2.2 WHEN<br>ENTER,<br>SHIFT, SKIP,<br>PT1-3 OR PT4<br>KEY KEPT<br>DEPRESSED.<br>0 WHEN<br>OTHER KEYS<br>KEPT DE-<br>PRESSED.<br>WAVEFORMS<br>P, Q, R,<br>S, T, U<br>AND V<br>WHEN<br>ENTER,<br>SHIFT, SKIP,<br>PT1-3 OR PT4<br>KEYED IN<br>RESPECTIVE-<br>LY)  | 0<br>(SAME AS<br>AM) | 0<br>(SAME AS<br>AM) |
|       | 13  | 0<br>(2.6 WHEN ANY BAND/MODE KEY OR ANY<br>MEMORY KEY b1-b8, c1-c8 OR d1-d8 KEYED<br>IN OR KEPT DEPRESSED.<br>SAMPLE WAVEFORMS W, X, Y, Z.<br>CENTER PULSE MOVES FROM LEFT TO<br>RIGHT PROPERLY 8 TIMES, I.E. 8-BIT<br>SYSTEM AS BAND/MODE IS KEYED IN<br>FROM LEFT (AIR) TO RIGHT (LSB/CW) OR<br>FOR EXAMPLE b1-b8. BACKS TO 0 WHEN<br>ABOVE DEPRESSED KEY IS RELEASED) |                      |                      |
|       | 14  | 0<br>(2.6 WHEN ANY KEY OF BANDS, AM MODES,<br>OPERATION TIME. a1-a8, d1-d8 KEPT DE-<br>PRESSED, AND 0 WHEN RELEASED)<br>SAMPLE WAVEFORMS WHEN KEYED IN:<br>AIR, a1, d1: W N, a5, d5: AA<br>FM, a2, d2: X SN, a6, d6: AB<br>AM, a3, d3: Y U, a7, d7: AC<br>W, a4, d4: Z L, a8, d8: AD   |                      |                      |
|       |     |  |                      |                      |
|       |     |  |                      |                      |
|       |     |  |                      |                      |
|       |     |  |                      |                      |
|       |     |  |                      |                      |
|       |     |  |                      |                      |
|       |     |  |                      |                      |
|       |     |  |                      |                      |

FOR SAMPLE WAVEFORMS, SEE PAGES FROM 53.

| IC    | PIN |   |
|-------|-----|---|
| IC501 | 15  | 0 (COMMON FOR ALL BANDS AND MODES) (2.6 WHEN ANY BAND/MODE KEY OR ANY OF MEMORY KEYS a1-a8, c1-c8, OR ANY OF TEN KEYS 0-7 KEYED IN (MOMENTARILY) OR KEPT DEPRESSED, AND BACKS TO 0 WHEN RELEASED)<br>SAMPLE WAVEFORMS WHEN KEYED IN FROM LEFT TO RIGHT:<br>AIR, 0, a1, c1: (W) N, 4, a5, c5: (AA)<br>FM, 1, a2, c2: (X) SN, 5, a6, c6: (AB)<br>AM, 2, a3, c3: (Y) U, 6, a7, c7: (AC)<br>W, 3, a4, c4: (Z) L, 7, a8, c8: (AD)  |
|       | 16  | 2.95. SAMPLE WAVEFORM: (N)  |
|       | 17  | 2.95. SAMPLE WAVEFORM: (M)  |
|       | 18  | 2.95. SAMPLE WAVEFORM: (L)  |
|       | 19  | 2.95. SAMPLE WAVEFORM: (K)  |
|       | 20  | 1.25 MICROCOMPUTER CLOCK.<br>SAMPLE WAVEFORM: (AJ)  |
|       | 21  | 1.0. MICROCOMPUTER CLOCK.<br>SAMPLE WAVEFORM: (AK)<br>(VOM IS NOT USABLE)   |
|       | 22  | 0 (ALL BANDS)   |
|       | 23  | 0 (ALL BANDS)   |
|       | 24  | 0.7 (ALL BANDS)   |
|       | 25  | 1.4 (ALL BANDS)   |
|       | 26  | 2.95 (ALL BANDS)  |
|       | 27  | NOT USED, BUT 1.1 (ALL BANDS)   |
|       | 28  | 1.3 (ALL BANDS)<br>SAMPLE WAVEFORM: (D).<br>DRIVES COMMON ELECTRODE FOR PM, PT1, PT2, PT4, 0, 15, 30, 60 ETC.   |
|       | 29  | 1.25 (ALL BANDS/MODES).<br>SAMPLE WAVEFORM: (D). DRIVES COMMON ELECTRODE FOR AM AND SEGMENTS a, d, e AND g OF FOURTH DIGIT OF CLOCK, ETC.   |
|       | 30  | 1.25 (ALL BANDS/MODES).<br>SAMPLE WAVEFORM: (D). DRIVES SEGMENTS a, b AND g OF TIMER-SIDE FIGURES.  |
|       | 31  | NOT USED, BUT 1.05 (ALL BANDS).   |
|       | 32  | NOT USED, BUT 1.05 (ALL BANDS).   |
|       | 33  | 0.7, SAMPLE WAVEFORM: (E).<br>DRIVES SEGMENTS b AND c OF TIMER'S MEMORY CH FIGURE OF DISPLAY.<br>PT1-PT4 KEPT DEPRESSED: 1.4, SAMPLE WAVEFORM (B). ANY ONE OF PT1-PT4 KEYS AND ANY ONE OF 15-60 MIN KEY ARE KEPT DEPRESSED SIMULTANEOUSLY.<br>1.25, SAMPLE WAVEFORM: (C)<br>PT1 KEPT DEPRESSED . . . . . SAMPLE WAVEFORM<br>↓<br>30 MIN KEYED IN . . . . . (C)<br>↓<br>DEPRESSING PT1<br>↓<br>a1, b1, c1, d1, }<br>a3, b3, c3, d3, }<br>a4, b4, c4, d4, }<br>a7, b7, c7, d7, }<br>a8, b8, c8, d8 }<br>KEYED IN . . . . . (C)<br>↓<br>a2, b2, c2, d2, }<br>a5, b5, c5, d5, }<br>a6, b6, c6, d6 }<br>KEYED IN . . . . . (A) |

| IC    | PIN |  |
|-------|-----|--|
| IC501 | 34  | 0.7, SAMPLE WAVEFORM: (E). DRIVES SEGMENTS a, d AND g OF TIMER'S MEMORY CH FIGURE.<br>PT1 KEPT DEPRESSED . . . . . SAMPLE WAVEFORM<br>↓<br>DEPRESSING PT1, UNCHANGED<br>a) a1-d1 KEYED IN . . . . . (E)<br>↓<br>b) a2-d2, a3-d3, a5-d5, a6-d6, a8-d8 KEYED IN } . . . . . (B)<br>↓<br>c) a4-d4, a7-d7 KEYED IN . . . . . (A)   |
|       | 35  | 0.7, SAMPLE WAVEFORM: E. DRIVES SEGMENTS e AND f OF TIMER'S MEMORY CH FIGURE AND ONE SEGMENT OF LETTERS a AND d OF MEMORY CH DISPLAY.<br>DEPRESSING PT1,<br>a) a1, a3, a7, b2-d2, b4-d4 b5-d5 KEYD IN } . . . . . SAMPLE WAVEFORM (A)<br>b) a6 OR a8 KEYED IN . . . . . (B)<br>c) a2, a4, a5, b6-d6, b8-d8. . . . . (C)<br>KEYED IN<br>d) b1-d1, b3-d3, b7-d7 KEYED IN . . . . . (E) |
|       | 36  | 0.7, SAMPLE WAVEFORM: (E). DRIVES THREE SEGMENTS OF LETTER d AND TWO SEGMENTS OF LETTER a, AND HYPHEN SEGMENT OF TIMER'S MEMORY CH DISPLAY.<br>DEPRESSING ANY OF PT1-PT4,<br>a) a1-a8, b1-b8 KEYED IN . . . . . SAMPLE WAVEFORM (C)<br>b) c1-c8 KEYED IN . . . . . (A)<br>c) d1-d8 KEYED IN . . . . . (B)  |
|       | 37  | DRIVES SEGMENTS b AND c OF FIRST DIGIT OF TIMER'S SLEEP TIME FIGURE.<br>1. POWER SWITCH (S502): TIMER 0.7,<br>SAMPLE WAVEFORM: (E)<br>2. SLEEP KEY KEYED IN;<br>a) 60 MIN OR 30 MIN DISPLAYED . . . . . SAMPLE WAVEFORM (C)<br>b) 15 MIN DISPLAYED . . . . . (A)   |
|       | 38  | DRIVES SEGMENTS a, d AND g OF FIRST DIGIT OF TIMER'S SLEEP TIME FIGURE.<br>1. POWER SWITCH (S502): TIMER 0.7,<br>SAMPLE WAVEFORM: (E)<br>2. SLEEP KEY KEYED IN;<br>a) 60 MIN OR 30 MIN DISPLAYED . . . . . SAMPLE WAVEFORM (C)<br>b) 15 MIN DISPLAYED. . . . . (B)   |
|       | 39  | DRIVES SEGMENTS e AND f OF FIRST DIGIT OF TIMER'S SLEEP TIME AND LETTERS "MIN".<br>1. POWER SWITCH (S502): TIMER 0.7,<br>SAMPLE WAVEFORM: (E)<br>2. SLEEP KEY KEYED IN;<br>a) 60 MIN OR 30 MIN DISPLAYED . . . . . SAMPLE WAVEFORM (B)<br>b) 15 MIN DISPLAYED. . . . . (C)   |

FOR SAMPLE WAVEFORMS, SEE PAGES FROM 53.

| IC    | PIN |   |
|-------|-----|---|
| IC501 | 40  | <p>DRIVES SEGMENTS b AND c OF SECOND DIGIT OF TIMERS SLEEP TIME FIGURE AND LETTERS "TIMER".</p> <p>1. POWER SWITCH (S502): TIMER 0.7, SAMPLE WAVEFORM: (E)</p> <p>2. SLEEP KEY KEYED IN;</p> <p>a) 60 MIN DISPLAYED . . . . . SAMPLE WAVEFORM (A)</p> <p>b) 30 MIN OR 15 MIN DISPLAYED. . . . . (C)</p>   |
|       | 41  | <p>DRIVES SEGMENTS a, d and g OF SECOND DIGIT OF TIMER'S SLEEP TIME FIGURE.</p> <p>1. POWER SWITCH (S502): TIMER 0.7, SAMPLE WAVEFORM: (E)</p> <p>2. SLEEP KEY KEYED IN;</p> <p>a) 60 MIN OR 30 MIN DISPLAYED . . . . . SAMPLE WAVEFORM (B)</p> <p>b) 15 MIN DISPLAYED. . . . . (E)</p>   |
|       | 42  | <p>DRIVES SEGMENTS e AND f OF SECOND DIGIT OF TIMER'S SLEEP TIME FIGURE AND ONE SEGMENT OF TIMER'S MEMORY CH LETTER "b".</p> <p>1. POWER SWITCH (S502): TIMER 0.7, SAMPLE WAVEFORM: (E)</p> <p>2. SLEEP KEY KEYED IN;</p> <p>a) 60 MIN DISPLAYED. . . . . SAMPLE WAVEFORM (C)</p> <p>b) 30 MIN OR 15 MIN DISPLAYED . . . . . (E)</p>  |
|       | 43  | <p>DRIVES CLOCK'S COLON, "PT3" AND FIGURES "15".</p> <p>1.05, SAMPLE WAVEFORM: (A) (UNCHANGES)</p>  |
|       | PT3 |   |
|       | 15  |   |
|       | 44  | <p>DRIVES SEGMENTS b AND c OF FIRST DIGIT OF CLOCK'S FIGURE, AND FIGURE "60".</p> <p>1. POWER ON AND INITIAL CLOCK DISPLAY 0:00. 1.25, SAMPLE WAVEFORM (C).</p> <p>2. WHEN FIGURE OF FIRST DIGIT CHANGED AS CLOCK TIME ADVANCES,</p> <p>a) FIGURES 2, 5 AND 6 DISPLAYED . . . . . SAMPLE WAVEFORM (A)</p> <p>b) FIGURES 0, 1, 3, 4, 7-9 DISPLAYED . . . . . (C)</p>   |
|       | 60  |   |
|       | 45  | <p>DRIVES SEGMENTS a, d AND g OF FIRST DIGIT OF CLOCK'S FIGURE.</p> <p>1. POWER ON AND INITIAL CLOCK DISPLAY 0:00. 1.25, SAMPLE WAVEFORM (C).</p> <p>2. WHEN FIGURE OF FIRST DIGIT CHANGED AS CLOCK TIME ADVANCES,</p> <p>a) FIGURE 0 DISPLAYED . . . . . SAMPLE WAVEFORM (C)</p> <p>b) FIGURE 1 DISPLAYED . . . . . (E)</p> <p>c) FIGURE 2, 3, 5, 6, 8 AND 9 DISPLAYED . . . . . (B)</p> <p>d) FIGURES 4 AND 7 DISPLAYED . . . . . (A)</p> |





| IC    | PIN |   |
|-------|-----|---|
| IC501 | 46  | <p>DRIVES SEGMENTS e AND f OF FIRST DIGIT OF CLOCK'S FIGURE, AND LETTERS "SLEEP".</p> <p>1. POWER ON AND INITIAL CLOCK DISPLAY 0:00. 1.25, SAMPLE WAVEFORM (C).</p> <p>2. WHEN FIGURE OF FIRST DIGIT CHANGED AS CLOCK TIME ADVANCES,</p> <p>a) FIGURE 0, 6 AND 8 DISPLAYED . . . . . SAMPLE WAVEFORM (C)</p> <p>b) FIGURES 1, 3 AND 7 DISPLAYED . . . . . (E)</p> <p>c) FIGURES 2, 4, 5 AND 9 DISPLAYED . . . . . (A)</p>   |
|       | 47  | <p>DRIVES SEGMENTS b AND c OF SECOND DIGIT OF CLOCK'S FIGURE, AND "PT4".</p> <p>1. POWER ON AND INITIAL CLOCK DISPLAY 0:00. 1.25, SAMPLE WAVEFORM: (C).</p> <p>2. WHEN FIGURE OF SECOND DIGIT CHANGED AS CLOCK TIME ADVANCES,</p> <p>a) FIGURES 0, 1, 3 AND 4 DISPLAYED . . . . . SAMPLE WAVEFORM (C)</p> <p>b) FIGURE 2 AND 5 DISPLAYED . . . . . (A)</p> <p>Note: FIGURES 6 THROUGH 9 ARE NOT DISPLAYED, BECAUSE THESE ARE NOT NECESSARY.</p>   |
|       | PT4 |   |
|       | 48  | <p>DRIVES SEGMENTS a, d, AND g OF SECOND DIGIT OF CLOCK'S FIGURE.</p> <p>1. POWER ON AND INITIAL DISPLAY 0:00. 1.25, SAMPLE WAVEFORM: (C).</p> <p>2. WHEN FIGURE OF SECOND DIGIT CHANGED AS CLOCK TIME ADVANCES,</p> <p>a) FIGURE 0 DISPLAYED . . . . . SAMPLE WAVEFORM (C)</p> <p>b) FIGURE 1 DISPLAYED . . . . . (E)</p> <p>c) FIGURES 2, 3 AND 5 DISPLAYED . . . . . (B)</p> <p>d) FIGURE 4 DISPLAYED . . . . . (A)</p> <p>Note: FIGURES 6 THROUGH 9 ARE NOT DISPLAYED, BECAUSE THESE ARE NOT NECESSARY.</p> |
|       | PT3 |   |
|       | 49  | <p>DRIVES SEGMENTS e AND f OF SECOND DIGIT OF CLOCK'S FIGURE, AND FIGURES "30".</p> <p>1. POWER ON AND INITIAL DISPLAY 0:00. 1.25, SAMPLE WAVEFORM: (C).</p> <p>2. WHEN FIGURE OF SECOND DIGIT CHANGED AS CLOCK TIME ADVANCES,</p> <p>a) FIGURE 0 DISPLAYED . . . . . SAMPLE WAVEFORM (C)</p> <p>b) FIGURES 1 AND 3 DISPLAYED . . . . . (E)</p> <p>c) FIGURE 2, 4 AND 5 DISPLAYED . . . . . (A)</p> <p>Note: FIGURES 6 THROUGH 9 ARE NOT DISPLAYED, BECAUSE THESE ARE NOT NECESSARY.</p>                        |
|       | 30  |   |
|       | 50  | <p>DRIVES SEGMENTS b AND c OF THIRD DIGIT OF CLOCK'S FIGURE, AND "PT2".</p> <p>1. POWER ON AND INITIAL DISPLAY 0:00. 1.25, SAMPLE WAVEFORM: (C).</p> <p>2. WHEN FIGURE OF THIRD DIGIT CHANGED AS CLOCK TIME ADVANCES,</p> <p>a) FIGURES 0, 1, 3, 4, 7-9 DISPLAYED . . . . . SAMPLE WAVEFORM (C)</p> <p>b) FIGURES 2, 5 AND 6 DISPLAYED . . . . . (A)</p>  |
|       | PT2 |   |

FOR SAMPLE WAVEFORMS, SEE PAGES FROM 53.

| IC PIN         |   |
|----------------|---|
| IC501 51       | <p>DRIVES SEGMENTS a, d AND g OF THIRD DIGIT OF CLOCK'S FIGURE.</p> <p>1. POWER ON AND INITIAL DISPLAY 0:00.<br/>1.25, SAMPLE WAVEFORM: (C)</p> <p>2. WHEN FIGURE OF THIRD DIGIT CHANGED AS CLOCK TIME ADVANCES,<br/>a) FIGURE 0 SAMPLE DISPLAYED . . . . . WAVEFORM (C)<br/>b) FIGURE 1 DISPLAYED . . . . . (E)<br/>c) FIGURES 2, 3 5, 6, 8 AND 9 DISPLAYED . . . . . (B)<br/>d) FIGURES 4 AND 7 DISPLAYED . . . . . (A)</p> |
| 52<br>PT1      | <p>DRIVES SEGMENTS e AND f OF THIRD DIGIT OF CLOCK'S FIGURE, AND "PT1".</p> <p>1. POWER ON AND INITIAL DISPLAY 0:00.<br/>1.25, SAMPLE WAVEFORM: (C)</p> <p>2. WHEN FIGURE OF THIRD DIGIT CHANGED AS CLOCK TIME ADVANCES,<br/>a) FIGURES 0, 6 AND 8 SAMPLE DISPLAYED . . . . . WAVEFORM (C)<br/>b) FIGURE 1, 3 AND 7 DISPLAYED . . . . . (E)<br/>c) FIGURE 2, 4, 5 AND 9 DISPLAYED . . . . . (A)</p>                           |
| 53<br>OR<br>28 | <p>DRIVES FOURTH DIGIT OF CLOCK'S FIGURE, I.E., 1 OR 2.</p> <p>1. POWER ON AND INITIAL CLOCK DISPLAY 0:00.<br/>0.7, SAMPLE WAVEFORM: (E)<br/>(FOURTH DIGIT IS VACANT).</p> <p>2. WHEN FIGURE OF FOURTH DIGIT CHANGED AS CLOCK TIME ADVANCES, SAMPLE WAVEFORM IS (C) FOR BOTH FIGURES 1 AND 2.<br/>Note: FIGURES 1 AND 2 ARE EFFEC-TIVE, AND OTHERS ARE NOT NECESSARY AND NOT DIS-PLAYED.</p>                                  |
| 54<br>AM<br>PM | <p>DRIVES LETTERS "AM" AND "PM".</p> <p>1. WHEN BOTH "AM" AND "PM" ARE NOT DISPLAYED:<br/>0.7, SAMPLE WAVEFORM: (E)</p> <p>2. WHEN "AM" OR "PM" DISPLAYED:<br/>1.05, SAMPLE WAVEFORM: (A)</p>   |
| 55             | <p>0 OR 3.0.</p> <p>1. RECEIVES ALTERNATE 0V ("L") AND +3V ("H") DC SIGNALS FROM ROTARY ENCODER. 0V ("L") OR +3V ("H") STATE DEPENDS UPON STOPPING POSITION OF TUNING KNOB.</p> <p>2. SAMPLE WAVEFORMS: (AL), (AM) AND (BC)</p>   |
| 56             | <p>3. COMMON FOR ALL BANDS.</p>   |
| 56             | <p>0 (ALL BANDS)</p> <p>1.25 (ALL BANDS/ MODES). MICROCOMPUTER CLOCK SAMPLE WAVEFORM: (AN)</p>  |
| 58             | <p>2.95 (ALL BANDS/MODES)</p>   |
| 59             | <p>1.5. SAMPLE WAVEFORM: (AO)</p>   |
| 60             | <p>3.4.</p> <p>TAKES ABOUT 25 MINUTES TO FULLY DISCHARGE AFTER TURNING BOTH POWER SWITCHES OFF.</p>   |
| 61             | <p>1. WITH CLOCKWISE TURNING OF TUNING KNOB, ALTERNATE 0 AND 3.0 (ALL BANDS). "L" AND "H" DEPENDS UPON SETTING OF TUNING KNOB.<br/>SAMPLE WAVEFORM: (AP)</p> <p>2. 0 WITH COUNTERCLOCKWISE TURNING OF TUNING KNOB.</p>  |

| IC PIN   | AM  | FM   | AIR  |
|----------|---|------|------|
| IC501 62 |   |      |      |
| 63       |   |      |      |
| 64       |   |      |      |
| IC502 1  |   |      |      |
| 2        |   |      |      |
| 3        |   |      |      |
| 4        |   |      |      |
| 5        |   |      |      |
| 6        |   |      |      |
| 7        |   |      |      |
| 8        |   |      |      |
| 9        |   |      |      |
| 10       | LW: 0<br>MW: 3.0<br>SW: 3.0                             | 0    | 0    |
| 11       | LW: 3.0<br>MW: 0<br>SW: 3.0                             | 0    | 0    |
| 12       | 0   | 0    | 0    |
| 13       | 0   | 0    | 0    |
| 14       | 2.95  | 2.95 | 2.95 |
| 15       | 0   | 2.95 | 0    |
| 16       | W, N, SF: 2.95<br>SN, U, L: 0                           | 0    | 2.95 |
| 17       | U, L: 2.95<br>OTHERS: 0                                 | 0    | 0    |
| 18       | W, N, SF, U: 2.95<br>SN, L: 0                           | 0    | 2.95 |
| 19       | W, SF, SN: 0<br>N, U, L: 2.95                           | 0    | 0    |
| 20       | NOT USED, BUT 1.0 (ALL BANDS).<br>SAMPLE WAVEFORM: (AK) |      |      |
| 21       | 1.25<br>MICROCOMPUTER CLOCK.<br>SAMPLE WAVEFORM: (AJ)   |      |      |
| 22, 23   | 0 (ALL BANDS)   |      |      |
| 24       | 1.2 (ALL BANDS). LCD VOLTAGE.                           |      |      |
| 25       | 1.4 (ALL BANDS). LCD VOLTAGE.                           |      |      |
| 26       | 2.95 (ALL BANDS).                                       |      |      |
| 27       | NOT USED, BUT 1.05 (ALL BANDS)<br>SAMPLE WAVEFORM: (E)  |      |      |

FOR SAMPLE WAVEFORMS, SEE PAGES FROM 53.

| IC    | PIN |  |     |     |     |     |     |     |   |   |   |   |     |     |     |     |     |     |     |     |   |     |     |     |     |     |     |     |     |   |     |     |     |     |     |     |     |     |   |     |     |     |     |     |     |     |     |
|-------|-----|--|-----|-----|-----|-----|-----|-----|---|---|---|---|-----|-----|-----|-----|-----|-----|-----|-----|---|-----|-----|-----|-----|-----|-----|-----|-----|---|-----|-----|-----|-----|-----|-----|-----|-----|---|-----|-----|-----|-----|-----|-----|-----|-----|
| IC502 | 28  | 1.25<br>DRIVES COMMON ELECTRODE FOR DISPLAYS AM, MW 9 kHz, MW 10 kHz, SCAN1, SCAN2, MHz, ETC. SEE PAGE 59.<br>SAMPLE WAVEFORM: (D)   |     |     |     |     |     |     |   |   |   |   |     |     |     |     |     |     |     |     |   |     |     |     |     |     |     |     |     |   |     |     |     |     |     |     |     |     |   |     |     |     |     |     |     |     |     |
|       | 29  | 1.25<br>DRIVES COMMON ELECTRODE FOR DISPLAYS FM AND 28 OTHER ELEMENTS OR SEGMENTS. SEE PAGE 59.<br>SAMPLE WAVEFORM: (D)  |     |     |     |     |     |     |   |   |   |   |     |     |     |     |     |     |     |     |   |     |     |     |     |     |     |     |     |   |     |     |     |     |     |     |     |     |   |     |     |     |     |     |     |     |     |
|       | 30  | 1.25<br>SAMPLE WAVEFORM: (D)<br>DRIVES COMMON ELECTRODES FOR DISPLAYS AIR, WIDE, NARROW, SYNC, USB, LSB/CW, kHz, SCAN AND 16 OTHER ELEMENTS OR SEGMENTS. SEE PAGE 59.  |     |     |     |     |     |     |   |   |   |   |     |     |     |     |     |     |     |     |   |     |     |     |     |     |     |     |     |   |     |     |     |     |     |     |     |     |   |     |     |     |     |     |     |     |     |
|       | 31  | 0.75. SAMPLE WAVEFORM: (E).<br>DRIVES SEGMENTS b AND d OF SCANNING CHANNEL'S FIGURE, AND DISPLAY "SCAN".<br>  |     |     |     |     |     |     |   |   |   |   |     |     |     |     |     |     |     |     |   |     |     |     |     |     |     |     |     |   |     |     |     |     |     |     |     |     |   |     |     |     |     |     |     |     |     |
|       |     | 1. FIGURES 1, 3, 4, 7 AND 8 DISPLAYED . . . . . SAMPLE WAVEFORM (C)  |     |     |     |     |     |     |   |   |   |   |     |     |     |     |     |     |     |     |   |     |     |     |     |     |     |     |     |   |     |     |     |     |     |     |     |     |   |     |     |     |     |     |     |     |     |
|       |     | 2. FIGURES 2, 5 AND 6 DISPLAYED . . . . . (A)  |     |     |     |     |     |     |   |   |   |   |     |     |     |     |     |     |     |     |   |     |     |     |     |     |     |     |     |   |     |     |     |     |     |     |     |     |   |     |     |     |     |     |     |     |     |
|       | 32  | 0.75, SAMPLE WAVEFORM: (E).<br>DRIVES SEGMENTS a, d AND g OF SCANNING CHANNEL'S FIGURE.<br>   |     |     |     |     |     |     |   |   |   |   |     |     |     |     |     |     |     |     |   |     |     |     |     |     |     |     |     |   |     |     |     |     |     |     |     |     |   |     |     |     |     |     |     |     |     |
|       | 33  | 0.75. SAMPLE WAVEFORM: (E).<br>DRIVES SEGMENTS e AND f OF SCANNING CHANNEL'S FIGURE, AND ONE SEGMENT OF SCANNING CHANNEL'S LETTER "a" OR "d".<br>SAMPLE WAVEFORMS WHEN SCANNING CHANNELS DISPLAYED.  |     |     |     |     |     |     |   |   |   |   |     |     |     |     |     |     |     |     |   |     |     |     |     |     |     |     |     |   |     |     |     |     |     |     |     |     |   |     |     |     |     |     |     |     |     |
|       |     | <table border="1"> <thead> <tr> <th></th> <th>1</th> <th>2</th> <th>3</th> <th>4</th> <th>5</th> <th>6</th> <th>7</th> <th>8</th> </tr> </thead> <tbody> <tr> <th>a</th> <td>(A)</td> <td>(C)</td> <td>(A)</td> <td>(C)</td> <td>(C)</td> <td>(B)</td> <td>(A)</td> <td>(B)</td> </tr> <tr> <th>b</th> <td>(E)</td> <td>(A)</td> <td>(E)</td> <td>(A)</td> <td>(A)</td> <td>(C)</td> <td>(E)</td> <td>(C)</td> </tr> <tr> <th>c</th> <td>(E)</td> <td>(A)</td> <td>(E)</td> <td>(A)</td> <td>(A)</td> <td>(C)</td> <td>(E)</td> <td>(C)</td> </tr> <tr> <th>d</th> <td>(E)</td> <td>(A)</td> <td>(E)</td> <td>(A)</td> <td>(A)</td> <td>(C)</td> <td>(E)</td> <td>(C)</td> </tr> </tbody> </table> |     | 1   | 2   | 3   | 4   | 5   | 6 | 7 | 8 | a | (A) | (C) | (A) | (C) | (C) | (B) | (A) | (B) | b | (E) | (A) | (E) | (A) | (A) | (C) | (E) | (C) | c | (E) | (A) | (E) | (A) | (A) | (C) | (E) | (C) | d | (E) | (A) | (E) | (A) | (A) | (C) | (E) | (C) |
|       | 1   | 2  | 3   | 4   | 5   | 6   | 7   | 8   |   |   |   |   |     |     |     |     |     |     |     |     |   |     |     |     |     |     |     |     |     |   |     |     |     |     |     |     |     |     |   |     |     |     |     |     |     |     |     |
| a     | (A) | (C)  | (A) | (C) | (C) | (B) | (A) | (B) |   |   |   |   |     |     |     |     |     |     |     |     |   |     |     |     |     |     |     |     |     |   |     |     |     |     |     |     |     |     |   |     |     |     |     |     |     |     |     |
| b     | (E) | (A)  | (E) | (A) | (A) | (C) | (E) | (C) |   |   |   |   |     |     |     |     |     |     |     |     |   |     |     |     |     |     |     |     |     |   |     |     |     |     |     |     |     |     |   |     |     |     |     |     |     |     |     |
| c     | (E) | (A)  | (E) | (A) | (A) | (C) | (E) | (C) |   |   |   |   |     |     |     |     |     |     |     |     |   |     |     |     |     |     |     |     |     |   |     |     |     |     |     |     |     |     |   |     |     |     |     |     |     |     |     |
| d     | (E) | (A)  | (E) | (A) | (A) | (C) | (E) | (C) |   |   |   |   |     |     |     |     |     |     |     |     |   |     |     |     |     |     |     |     |     |   |     |     |     |     |     |     |     |     |   |     |     |     |     |     |     |     |     |
|       | 34  | 0.7V, SAMPLE WAVEFORM: (E).<br>DRIVES TWO SEGMENTS OF "a", THREE SEGMENTS OF "d" AND HYPHEN IN SCANNING CHANNEL'S DISPLAY.<br>1. MEMORY/SCANNING CHANNELS OF ROWS a AND b DISPLAYED;<br>SAMPLE WAVEFORM: (C)<br>2. MEMORY/SCANNING CHANNELS OF ROW c DISPLAYED;<br>SAMPLE WAVEFORM: (A)<br>3. MEMORY/SCANNING CHANNELS OF ROW d DISPLAYED;<br>SAMPLE WAVEFORM: (B)<br>  |     |     |     |     |     |     |   |   |   |   |     |     |     |     |     |     |     |     |   |     |     |     |     |     |     |     |     |   |     |     |     |     |     |     |     |     |   |     |     |     |     |     |     |     |     |
|       | 35  | 1.05, SAMPLE WAVEFORM: (A).<br>DRIVES ONE SEGMENT OF LETTER "b" AND TRIANGULAR MARK IN MEMORY/SCANNING CHANNEL'S DISPLAY.<br>1. MEMORY/SCANNING CHANNELS OF ROWS a, c AND d DISPLAYED;<br>SAMPLE WAVEFORM: (C).<br>2. MEMORY/SCANNING CHANNELS OF ROW b DISPLAYED;<br>SAMPLE WAVEFORM: (B).<br>   |     |     |     |     |     |     |   |   |   |   |     |     |     |     |     |     |     |     |   |     |     |     |     |     |     |     |     |   |     |     |     |     |     |     |     |     |   |     |     |     |     |     |     |     |     |

| IC    | PIN   | AM   | FM  | AIR |
|-------|---|--|---|-----|
| IC502 | 36  |  |   |     |
|       |  kHz |  |   |     |
|       |   | 1. INITIAL SAMPLE WAVEFORM: (B)  | 1. INITIAL SAMPLE WAVEFORM: (C)   |     |
|       |   | 2. SAMPLE WAVEFORM (A) FOR 5 SECONDS AFTER KEYED FREQUENCY IN FROM TEN KEYS AND NOT EXECUTED, AND BACKS TO INITIAL STATE.                                  | 2. SAMPLE WAVEFORM E FOR 5 SECONDS AFTER KEYED FREQUENCY IN FROM TEN KEYS AND NOT EXECUTED, AND BACKS TO INITIAL STATE.                                     |     |
|       |   | 3. WHEN EXECUTED AND FREQUENCY CHANGED, a) FIGURES 0,1,3,4,7,8 AND 9 DISPLAYED; SAMPLE WAVEFORM: (B) b) FIGURES 2, 5 AND 6 DISPLAYED; SAMPLE WAVEFORM: (C) | 3. WHEN EXECUTED AND FREQUENCY IS CHANGED, a) .000 MHz AND .050 MHz DISPLAYED; SAMPLE WAVEFORM: (C) b) .025MHz AND .075 MHz DISPLAYED; SAMPLE WAVEFORM: (A) |     |
|       |   |  | Note: FM BAND IS OF .050 MHz AND AIR BAND IS OF .025MHz CHANNEL STEP, SO FIRST DIGIT IS 0 OR 5.   |     |

FOR SAMPLE WAVEFORMS, SEE PAGES FROM 53.

| IC    | PIN   | AM   | FM | AIR |  |  |
|-------|-------|--|----|-----|--|--|
| IC502 | 37    | <p>1.25. INITIAL SAMPLE WAVEFORM: (C)<br/>(FIRST FREQUENCY DIGIT IS 0)<br/>DRIVES SEGMENTS a, d AND g OF FIRST<br/>DIGIT OF FREQUENCY DISPLAY.</p> <p>1. SAMPLE WAVEFORM (E) FOR 5 SECONDS<br/>AFTER KEYED FREQUENCY IN FROM<br/>TEN KEYS AND NOT EXECUTED, AND<br/>BACKS TO INITIAL STATE.</p> <p>2. WHEN EXECUT-<br/>ED AND FRE-<br/>QUENCY<br/>CHANGED,<br/>a) FIGURES<br/>0 DIS-<br/>PLAYED;<br/>SAMPLE<br/>WAVE-<br/>FORM: (C)</p> <p>b) FIGURE 1<br/>DIS-<br/>PLAYED;<br/>SAMPLE<br/>WAVE-<br/>FORM: (E)</p> <p>c) FIGURES<br/>2,3,5,6,8<br/>AND 9<br/>DIS-<br/>PLAYED;<br/>SAMPLE<br/>WAVE-<br/>FORM: (B)</p> <p>d) FIGURES<br/>4 AND 7<br/>DIS-<br/>PLAYED;<br/>SAMPLE<br/>WAVE-<br/>FORM: (A)</p> |    |     | <p>2. DISPLAY<br/>IS AL-<br/>WAYS 0<br/>AND<br/>SAMPLE<br/>WAVE-<br/>FORM IS<br/>ALWAYS<br/>(C).</p> | <p>2. WHEN EXECUT-<br/>ED AND FRE-<br/>QUENCY<br/>CHANGED,<br/>a) .000MHz,<br/>.050MHz<br/>AND .100<br/>MHz DIS-<br/>PLAYED;<br/>SAMPLE<br/>WAVE-<br/>FORM: (C)</p> <p>b) .025MHz<br/>AND .075<br/>MHz DIS-<br/>PLAYED;<br/>SAMPLE<br/>WAVE-<br/>FORM: (B)</p> |
| 38    | SCAN2 | <p>1.4. INITIAL SAMPLE WAVEFORM: (B)<br/>(FIRST FREQUENCY DIGIT IS 0)<br/>DRIVES SEGMENTS e AND f OF FIRST<br/>DIGIT OF FREQUENCY DISPLAY AND<br/>"SCAN2".</p> <p>WHEN FRE-<br/>QUENCY IS<br/>EXECUTED<br/>AND<br/>CHANGED<br/>AND,<br/>a) FIGURES<br/>0, 6 AND<br/>8 DIS-<br/>PLAYED;<br/>SAMPLE<br/>WAVE-<br/>FORM: (B)</p> <p>b) FIGURES<br/>1, 3 AND<br/>7 DIS-<br/>PLAYED;<br/>WAVE-<br/>FORM: (A)</p> <p>c) FIGURES<br/>2,4,5 AND<br/>9 DIS-<br/>PLAYED;<br/>SAMPLE<br/>WAVE-<br/>FORM: (C)</p>  |    |     | <p>SAMPLE<br/>WAVEFORM:<br/>ALWAYS (B)<br/>(FIGURE<br/>DISPLAYED<br/>IS ALWAYS<br/>0)</p>            | <p>WHEN FRE-<br/>QUENCY IS<br/>EXECUTED<br/>AND<br/>CHANGED<br/>AND,<br/>a) FIGURE<br/>0 DIS-<br/>PLAYED;<br/>SAMPLE<br/>WAVE-<br/>FORM: (B)</p> <p>b) FIGURE<br/>5 DIS-<br/>PLAYED;<br/>SAMPLE<br/>WAVE-<br/>FORM: (C)</p>                                    |

| IC    | PIN | AM  | FM | AIR |   |   |
|-------|-----|---|----|-----|---|---|
| IC502 | 39  | <p>DRIVES SEGMENTS b AND c OF SECOND<br/>DIGIT OF FREQUENCY DISPLAY, AND<br/>"LSB/CW" DISPLAY.</p> <p>LSB/CW</p> <p>WHEN FRE-<br/>QUENCY IS<br/>EXECUTED<br/>AND FIG-<br/>URE OF<br/>SECOND<br/>DIGIT IS<br/>CHANGED<br/>AND,<br/>a) FIGURES<br/>0,1,3,4,7,8<br/>AND 9<br/>DIS-<br/>PLAYED;<br/>SAMPLE<br/>WAVE-<br/>FORM: (C)</p> <p>b) FIGURES<br/>2, 5 AND<br/>6 DIS-<br/>PLAYED;<br/>SAMPLE<br/>WAVE-<br/>FORM: (A)</p>   |    |     | <p>WHEN FRE-<br/>QUENCY IS<br/>EXECUTED<br/>AND FIG-<br/>URE OF<br/>SECOND<br/>DIGIT IS<br/>CHANGED<br/>AND,<br/>a) FIGURE 0<br/>DIS-<br/>PLAYED;<br/>SAMPLE<br/>WAVE-<br/>FORM: (C)</p> <p>b) FIGURE<br/>5 DIS-<br/>PLAYED;<br/>SAMPLE<br/>WAVE-<br/>FORM: (A)</p> | <p>WHEN FRE-<br/>QUENCY IS<br/>EXECUTED<br/>AND FIG-<br/>URE OF<br/>SECOND<br/>DIGIT IS<br/>CHANGED<br/>AND,<br/>a) FIGURES<br/>0 AND 7<br/>DIS-<br/>PLAYED;<br/>SAMPLE<br/>WAVE-<br/>FORM: (C)</p> <p>b) FIGURES<br/>2 AND 5<br/>DIS-<br/>PLAYED;<br/>SAMPLE<br/>WAVE-<br/>FORM: (A)</p> |
| 40    |     | <p>DRIVES SEGMENTS a, d AND g OF SECOND<br/>DIGIT OF FREQUENCY DISPLAY.<br/>WHEN FREQUENCY IS EXECUTED AND<br/>FIGURE OF SECOND DIGIT IS CHANGED<br/>AND,<br/>a) FIGURE 0 DISPLAYED;<br/>SAMPLE WAVEFORM: (C).</p> <p>b) FIGURE 1 DISPLAYED;<br/>SAMPLE WAVEFORM: (E).</p> <p>c) FIGURES 2, 3, 5, 6, 8 AND 9 DISPLAYED;<br/>SAMPLE WAVEFORM: (B).</p> <p>d) FIGURES 4 AND 7 DISPLAYED;<br/>SAMPLE WAVEFORM: (A)</p>   |    |     |   |   |
| 41    |     | <p>DRIVES SEGMENTS e AND f OF SECOND<br/>DIGIT OF FREQUENCY DISPLAY, AND<br/>"DOT".</p> <p>WHEN FRE-<br/>QUENCY IS<br/>EXECUTED<br/>AND FIG-<br/>URE OF<br/>SECOND<br/>DIGIT<br/>CHANGED<br/>AND,<br/>a) FIGURES<br/>0,6 AND 8<br/>DIS-<br/>PLAYED;<br/>SAMPLE<br/>WAVE-<br/>FORM: (B)</p> <p>b) FIGURES<br/>1, 3 AND<br/>7 DIS-<br/>PLAYED;<br/>SAMPLE<br/>WAVE-<br/>FORM: (A)</p> <p>c) FIGURES<br/>2,4,5 AND<br/>9 DIS-<br/>PLAYED;<br/>SAMPLE<br/>WAVE-<br/>FORM: (C)</p> |    |     | <p>WHEN FREQUENCY IS EXE-<br/>CUTED AND FIGURE OF<br/>SECOND DIGIT CHANGED<br/>AND,<br/>a) FIGURE 0 DISPLAYED;<br/>SAMPLE WAVEFORM: (C)</p> <p>b) FIGURE 5 DISPLAYED;<br/>SAMPLE WAVEFORM: (A)</p>  | <p>c) FIGURE 2<br/>DIS-<br/>PLAYED;<br/>SAMPLE<br/>WAVE-<br/>FORM: (A)</p> <p>d) FIGURE<br/>7 DIS-<br/>PLAYED;<br/>SAMPLE<br/>WAVE-<br/>FORM: (E)</p>   |

FOR SAMPLE WAVEFORMS, SEE PAGES FROM 53.

| IC    | PIN              | AM  | FM  | AIR |
|-------|------------------|---|---|-----|
| IC502 | 42<br>USB<br>    | <p>DRIVES SEGMENTS b AND c OF THIRD DIGIT OF FREQUENCY DISPLAY, AND "USB".</p> <p>WHEN FREQUENCY IS EXECUTED AND FIGURE OF THIRD DIGIT CHANGED AND,</p> <p>a) FIGURES 0, 1, 3, 4, 7, 8 AND 9 DISPLAYED;<br/>SAMPLE WAVEFORM: (C)</p> <p>b) FIGURES 2, 5 AND 6 DISPLAYED;<br/>SAMPLE WAVEFORM: (A)</p> <p>SAME AS THOSE AT PIN 50 OF IC501, AND THOSE AT PIN 39 OF IC502 IN "AM" BAND SHOWN ABOVE.</p> |   |     |
|       | 43<br>           | <p>DRIVES SEGMENTS a, d AND g OF THIRD DIGIT OF FREQUENCY DISPLAY.</p> <p>WHEN FREQUENCY IS EXECUTED AND FIGURE OF THIRD DIGIT CHANGED, SAMPLE WAVEFORMS ARE SAME AS PIN 40 OF IC502 IN "AM" BAND SHOWN ABOVE.</p>  |   |     |
|       | 44<br>SCAN1<br>  | <p>DRIVES SEGMENTS e AND f OF THIRD DIGIT OF FREQUENCY DISPLAY, AND "SCAN 1".</p> <p>WHEN FREQUENCY IS EXECUTED AND FIGURE OF THIRD DIGIT CHANGED, SAMPLE WAVEFORMS ARE SAME AS THOSE AT PIN 46 OF IC501 SHOWN ABOVE.</p>   |   |     |
|       | 45<br>SYNC<br>   | <p>DRIVES SEGMENTS b AND c OF FOURTH DIGIT OF FREQUENCY DISPLAY, AND "SYNC".</p> <p>WHEN FREQUENCY IS EXECUTED AND FIGURE OF FOURTH DIGIT CHANGED, SAMPLE WAVEFORMS ARE SAME AS THOSE AT PIN 42 OF IC502 SHOWN ABOVE.</p>   |   |     |
|       | 46<br>           | <p>DRIVES SEGMENTS a, d AND g OF FOURTH DIGIT OF FREQUENCY DISPLAY.</p> <p>WHEN FREQUENCY IS EXECUTED AND FIGURE OF FOURTH DIGIT CHANGED, SAMPLE WAVEFORMS ARE SAME AS THOSE AT PIN 40 OF IC502 IN "AM" MODE SHOWN ABOVE.</p>   |   |     |
|       | 47<br>MHz<br>    | <p>DRIVES SEGMENTS e AND f OF FOURTH DIGIT AND 1MHz DOT OF FREQUENCY DISPLAY, AND "MHz".</p> <p>WHEN FREQUENCY IS EXECUTED AND FIGURE OF FOURTH DIGIT CHANGED, SAMPLE WAVEFORMS ARE SAME AS THOSE AT PIN 46 OF IC501 SHOWN ABOVE.</p>   |   |     |
|       | 48<br>NARROW<br> | <p>DRIVE SEGMENTS b AND c OF FIFTH DIGIT OF FREQUENCY DISPLAY, AND "NARROW".</p> <p>AT INITIAL 150kHz,<br/>SAMPLE WAVEFORM (E)</p> <p>AT OFF-BAND WITH Error DISPLAY, ALSO (E)</p>  | <p>1. AT INITIAL 76MHz OR 116MHz, SAMPLE WAVEFORM (C).</p> <p>2. AT OFF-BANDS WITH Error DISPLAY, BLINKED WAVEFORMS (A) AND (E) FOR FIVE SECONDS.</p> |     |
|       | 49<br>           | <p>DRIVES SEGMENTS a, d AND g OF FIFTH DIGIT OF FREQUENCY DISPLAY.</p> <p>WHEN FREQUENCY IS EXECUTED AND FIFTH DIGIT OF FREQUENCY CHANGED, SAMPLE WAVEFORMS ARE THOSE AT PIN 40 OF IC502 IN "AM" MODE SHOWN ABOVE.</p> <p>NOTE:</p> <p>a) FIGURES FOR FM BAND ARE 7, 8, 9 AND 0 ONLY.</p> <p>b) FIGURES FOR AIR BAND ARE 1, 2 AND 3 ONLY.</p>   |   |     |

| IC    | PIN                      | AM  | FM   | AIR   |
|-------|--------------------------|---|--|---|
| IC502 | 50<br>MW10kHz<br>        | <p>DRIVES SEGMENTS e AND f OF FIFTH DIGIT OF FREQUENCY DISPLAY, AND "MW10kHz" DISPLAY.</p> <p>WHEN FREQUENCY IS EXECUTED AND FIFTH DIGIT OF FREQUENCY CHANGED, SAMPLE WAVEFORMS ARE THOSE AT PIN 46 OF IC501 IN OR THOSE AT PIN 47 OF IC502 IN "AM" BAND.</p> <p>NOTE:</p> <p>a) FIGURES FOR FM BAND ARE 7, 8, 9 AND 0 ONLY.</p> <p>b) FIGURES FOR AIR BAND ARE 1, 2 AND 3 ONLY.</p>  |  |   |
|       | 51<br>                   | <p>DRIVES SEGMENTS a, b, c, d, e AND g OF SIXTH DIGIT OF FREQUENCY DISPLAY.</p> <p>WHEN FREQUENCY IS EXECUTED AND SIXTH DIGIT OF FREQUENCY CHANGED,</p> <p>a) VACANT (NO DISPLAY); SAMPLE WAVEFORM: (E)</p> <p>b) FIGURES 1 AND 2 DISPLAYED; SAMPLE WAVEFORM: (C)</p> <p>c) WHEN OFF-BAND FREQUENCY EXECUTED AT LOWER END, Error DISPLAY BLINKS FOR FIVE SECONDS, AND BACKS TO INITIAL FREQUENCY; SAMPLE WAVEFORMS: ALTER-NATE (A) AND (E) DURING BLINKING.</p> | <p>a) VACANT (NO DISPLAY); SAMPLE WAVEFORM: (E)</p> <p>b) FIGURE 1 DISPLAYED; SAMPLE WAVEFORM: (C)</p> <p>c) WHEN OFF-BAND FREQUENCIES EXECUTED TO UPPER END, Error DISPLAY BLINKS FOR FIVE SECONDS, AND BACKS TO INITIAL FREQUENCY; SAMPLE WAVEFORMS: ALTER-NATE (A) AND (C) DURING BLINKING.</p> <p>d) LOWER-END OFF-BAND; ALTER-NATE (A) AND (E) DURING BLINKING.</p> | <p>a) FIGURE 1 ONLY AND SAMPLE WAVEFORM IS (C).</p> <p>b) WHEN OFF-BAND FREQUENCIES EXECUTED AT BOTH ENDS, Error DISPLAY BLINKS FOR FIVE SECONDS, AND BACKS TO INITIAL FREQUENCY; SAMPLE WAVEFORMS: ALTER-NATE (A) AND (C) DURING BLINKING.</p> |
|       | 52<br>WIDE<br>MW9kHz<br> | <p>DRIVES SEGMENT f (NOT USED IN THIS SET) OF SIXTH FREQUENCY DISPLAY, AND "WIDE" AND "MW9kHz" DISPLAYS.</p> <p>IN WIDE AND MW9kHz MODE, SAMPLE WAVEFORM (C).</p> <p>SAMPLE WAVEFORM IS ALWAYS (A).</p>   |  |   |
|       | 53<br>AIR<br>FM<br>AM    | <p>1.05.</p> <p>DRIVES SEGMENT "AM", "FM" OR "AIR".</p> <p>SAMPLE WAVEFORM: (A)</p>   |  |   |



FOR SAMPLE WAVEFORMS, SEE PAGES FROM 53.

| IC    | PIN  | AM   | FM | AIR |
|-------|--|--|----|-----|
| IC502 | 54   | 0.7. SAMPLE WAVEFORM: (E)<br>DRIVES TRIANGLE MARKS.  |    |     |
|       | 55   | 0 (GROUND) (ALL BANDS)   |    |     |
|       | 56   | 0 (ALL BANDS)  |    |     |
|       | 57   | 1.2. (ALL BANDS). CLOCK<br>SAMPLE WAVEFORM: (F)  |    |     |
|       | 58   | 2.95 (B+, ALL BANDS).  |    |     |
|       | 59   | 1.3 (ALL BANDS). CLOCK<br>SAMPLE WAVEFORM: (G)   |    |     |
|       | 60   | 0 OR 3.0. ACTIVATES "FAST" TUNING OF<br>AM MANUAL TUNE MODE.<br>0: "LOCK" AND "SLOW" POSITIONS.<br>3.0: "FAST" POSITION.   |    |     |
|       | 61   | 0 OR 3.0. ACTIVATES "SLOW" TUNING OF<br>MANUAL TUNE MODE.<br>0: "LOCK" AND "FAST" POSITIONS.<br>3.0: "SLOW" POSITION.  |    |     |
|       | 62   | 0 (ALL BANDS)  |    |     |
|       | 63   | 0 OR 2.75.<br>SAME AS PIN 10 OF IC501.   |    |     |
| 64    | 0 OR 0.15 OR 0.35.<br>SAME AS PIN 62 OF IC501. |  |    |     |
| IC503 | 1  | 0.<br>(2.6 WHEN b1-b8 KEYED IN AND KEPT<br>DEPRESSED.<br>0 WHEN OTHER KEYS KEYED IN.)  |    |     |
|       | 2  | 0.<br>(2.6 WHEN c1-c8 KEYED IN AND KEPT<br>DEPRESSED.<br>0 WHEN OTHER KEYS KEYED IN.)  |    |     |
|       | 3  | 0.<br>(2.6 WHEN d1-d8 KEYED IN AND KEPT<br>DEPRESSED.<br>0 WHEN OTHER KEYS KEYED IN.)  |    |     |
|       | 4  | 0.<br>(2.6 WHEN AIR, FM OR AM KEYED IN.)   |    |     |
|       | 5  | 3.0 (B+).  |    |     |
|       | 6  | 0.<br>(2.95 WHEN b1-b8, c1-c8, d1-d8, WIDE,<br>NARROW, SYNC, USB OR LSB/CW KEYED<br>IN.)<br>IDENTICAL TO PIN 13 OF IC501 (ICF-2010).   |    |     |
|       | 7  | 0.<br>(2.95 WHEN THOSE KEYS SHOWN FOR PIN<br>14 OF IC501 ARE KEYED IN. IDENTICAL<br>TO PIN 14 OF IC501).   |    |     |
|       | 8  | 0 (GROUND).  |    |     |
|       | 9  | 0.<br>(2.95 WHEN THOSE KEYS SHOWN FOR PIN<br>15 OF IC501 ARE KEYED IN. IDENTICAL<br>TO PIN 15 OF IC501).   |    |     |
|       | 10   | 0 (GROUND).  |    |     |
|       | 11   | 0.<br>(2.6 WHEN KEYS 0-7 ARE KEYED IN OR<br>KEPT DEPRESSED AT TEN KEY, AND<br>BACKS TO 0 WHEN KEY IS RELEASED.)<br>SAMPLE WAVEFORMS WHEN FIGURES<br>ARE KEYED IN;                |    |     |
|       | 12   | 0.<br>(2.6 WHEN 8, 9, EXECUTE, 0 MIN, 15 MIN,<br>30 MIN OR 60 MIN ARE KEYED IN OR KEPT<br>DEPRESSED, AND BACKS TO 0 WHEN KEY<br>IS RELEASED.)<br>SAMPLE WAVEFORMS WHEN KEYED IN; |    |     |

| IC    | PIN   | AM  | FM  | AIR          |  |
|-------|---|---|---|--------------|--|
| IC503 | 13  | 0.<br>(2.6 WHEN a1-a8 KEYED IN OR KEPT DE-<br>PRESSED, AND BACKS TO 0 WHEN KEY IS<br>RELEASED.)<br>SAMPLE WAVEFORMS WHEN KEYED IN;  |   |              |  |
|       |   | a1: (W)   | a4: (Z)   | a7: (AC)     |  |
|       |   | a2: (X)   | a5: (AA)  | a8: (AD)     |  |
|       |   | a3: (Y)   | a6: (AB)  |              |  |
|       | 14  | NOT USED, BUT 0.<br>(2.95 WHEN KEYS OTHER THAN LIGHT,<br>SLEEP, PT1-PT4, SCAN START/STOP,<br>MEMORY SCAN START/STOP, SKIP, ENTER<br>AND SHIFT ARE KEYED IN OR KEPT DE-<br>PRESSED, AND BACKS TO 0 WHEN KEY IS<br>RELEASED.)<br>SAMPLE WAVEFORMS ARE ALSO IN THE<br>ORDER OF (W) TO (AD) AS SHOWN ABOVE<br>IN 8-BIT SYSTEM.              |   |              |  |
|       | 15  | NOT USED, BUT 2.95.<br>(0 REVERSEWISE WHEN AIR, FM, AM, WIDE,<br>NARROW, SYNC, USB AND LSB/CW ARE<br>KEYED IN.)<br>SAMPLE WAVEFORMS WHEN KEYED IN.  |   |              |  |
|       |   | AIR: (AQ)   | WIDE: (AT)  | USB: (AW)    |  |
|       |   | FM: (AR)  | NARROW: (AU)  | LSB/CW: (AX) |  |
|       |   | AM: (AS)  | SYNC: (AV)  |              |  |
|       |   | OTHER KEYS ARE UNCHANGED WHEN<br>KEYED IN, I.E., 2.95.  |   |              |  |
|       | 16  | 3.0 (B+).   |   |              |  |
|       | IC504   | 1   | 0 OR 3.0 DEPENDING UPON STOP POSITION<br>OF TUNING KNOB.<br>1. ALTERNATE 0 AND 3.0 WHEN TUNING<br>KNOB TURNED COUNTERCLOCKWISE.<br>FREQUENCY DISPLAY'S FIGURE<br>CHANGES AT LEADING EDGE FROM 0V<br>TO 3.0V.<br>SAMPLE WAVEFORM: (AP) |              |  |
|       |   | 2   | UNCHANGED 0V WHEN TUNING KNOB<br>TURNED CLOCKWISE.  |              |  |
|       |   | 2   | NOT USED.   |              |  |
|       |   | 3   | 0.<br>(ALTERNATE 0 AND 3.0 FOLLOWING TURN<br>OF TUNING KNOB IN BOTH CLOCKWISE<br>AND COUNTERCLOCKWISE.)   |              |  |
|       |   | 4   | ALTERNATE 0 AND 3.0<br>FOLLOWING TURN OF TUNING KNOB IN<br>BOTH CLOCKWISE AND COUNTERCLOCK-<br>WISE. FREQUENCY DISPLAY FIGURE<br>CHANGES AT LEADING EDGE FROM 0V TO<br>3.0V.  |              |  |
| 5     |   | ALTERNATE 0 AND 3.0<br>FOLLOWING TURN OF TUNING KNOB.<br>1. 0 WHEN PIN 1 OF THIS IC IC504 IS 3.0<br>"H", AND 3.0 WHEN PIN 1 OF IC504 IS 0.<br>(REVERSAL OF PIN 1 OF IC507)<br>2. POINTS CAN BE DETECTED WHEN BOTH<br>PINS 1 OF IC507 AND 5 OF IC504 BE-<br>COMES IN 0 "L" OR 3.0 "H" AT THE<br>SAME TIME DURING TURN OF TUNING<br>KNOB. |   |              |  |
| 6     |   | 0 (GROUND).   |   |              |  |
| 7     |   | 0 (GROUND).   |   |              |  |
| 8     |   | 0 (GROUND).   |   |              |  |
| 9     | SAME AS PIN 3 OF THIS IC IC504 AND PIN 1<br>OF IC507. |   |   |              |  |

FOR SAMPLE WAVEFORMS, SEE PAGES FROM 53.

| IC    | PIN  | AM  | FM      | AIR |  |       |  |       |       |       |       |         |         |         |         |         |         |         |         |         |         |         |         |
|-------|--|---|---------|-----|--|-------|--|-------|-------|-------|-------|---------|---------|---------|---------|---------|---------|---------|---------|---------|---------|---------|---------|
| IC504 | 10   | 0.<br>(ALTERNATE 0 AND 3.0 WHEN TUNING KNOB TURNED IN BOTH DIRECTION OF CLOCKWISE AND COUNTERCLOCKWISE. REVERSAL OF PIN 11 OF IC505.)<br>SAMPLE WAVEFORM: (BC)  |         |     |  |       |  |       |       |       |       |         |         |         |         |         |         |         |         |         |         |         |         |
|       | 11   | SAME AS PIN 5 OF THIS IC IC504 AND PIN 2 OF IC507.  |         |     |  |       |  |       |       |       |       |         |         |         |         |         |         |         |         |         |         |         |         |
|       | 12   | NOT USED  |         |     |  |       |  |       |       |       |       |         |         |         |         |         |         |         |         |         |         |         |         |
|       | 13   | SAME AS PIN 61 OF IC501.  |         |     |  |       |  |       |       |       |       |         |         |         |         |         |         |         |         |         |         |         |         |
|       | 14   | 3.0 (B+).   |         |     |  |       |  |       |       |       |       |         |         |         |         |         |         |         |         |         |         |         |         |
| IC505 | 1  | 0 OR 3.0 DEPENDING UPON STOP POSITION OF TUNING KNOB.<br>(ALTERNATE 0 AND 3.0 WHEN TUNING KNOB IS TURNED. SAME AS PIN 4 OF IC502. REVERSAL OF PIN 2 OF IC505.)<br>SAMPLE WAVEFORM: (BF)   |         |     |  |       |  |       |       |       |       |         |         |         |         |         |         |         |         |         |         |         |         |
|       | 2  | 3.0 OR 0 DEPENDING UPON STOP POSITION OF TUNING KNOB.<br>(ALTERNATE 3.0 AND 0 WHEN TUNING KNOB IS TURNED. REVERSAL OF PIN 1 OF IC505. SAME AS PIN 3 OF IC502.)<br>SAMPLE WAVEFORMS: (BD) AND (BE)   |         |     |  |       |  |       |       |       |       |         |         |         |         |         |         |         |         |         |         |         |         |
|       | 3  | 3.0 OR 0 DEPENDING UPON STOP POSITION OF TUNING KNOB.<br>(ALTERNATE 3.0 AND 0 WHEN TUNING KNOB TURNED IN BOTH CLOCKWISE AND COUNTERCLOCKWISE DIRECTIONS. REVERSAL OF PIN 1 OF THIS IC IC505. FIGURE OF FREQUENCY DISPLAY CHANGES AT TRAILING EDGE FROM 3.0 "H" TO 0 ("L").<br>SAMPLE WAVEFORMS: (BE), (BF) AND (BG) |         |     |  |       |  |       |       |       |       |         |         |         |         |         |         |         |         |         |         |         |         |
|       | 4  | 3.0 OR 0 DEPENDING UPON STOP POSITION OF TUNING KNOB.<br>(ALTERNATE 3.0 AND 0 WHEN TUNING KNOB TURNED IN BOTH CLOCKWISE AND COUNTERCLOCKWISE DIRECTIONS. "H" OR "L" WHEN PIN 5 OF IC505 IS "H", AND "L" WHEN PIN 5 OF IC505 IS "L".   |         |     |  |       |  |       |       |       |       |         |         |         |         |         |         |         |         |         |         |         |         |
|       | 5  | 0 OR 3.0 DEPENDING UPON STOP POSITION OF TUNING KNOB AND STATES OF INPUT PINS 1 AND 2 OF IC507.   |         |     |  |       |  |       |       |       |       |         |         |         |         |         |         |         |         |         |         |         |         |
|       | <table border="1"> <thead> <tr> <th colspan="2">IC507</th> <th>IC505</th> </tr> <tr> <th>PIN 1</th> <th>PIN 2</th> <th>PIN 5</th> </tr> </thead> <tbody> <tr> <td>0V("L")</td> <td>0V("L")</td> <td>3V("H")</td> </tr> <tr> <td>3V("H")</td> <td>3V("H")</td> <td>0V("L")</td> </tr> <tr> <td>3V("H")</td> <td>0V("L")</td> <td>0V("L")</td> </tr> <tr> <td>0V("L")</td> <td>3V("L")</td> <td>0V("L")</td> </tr> </tbody> </table> |   |         |     |  | IC507 |  | IC505 | PIN 1 | PIN 2 | PIN 5 | 0V("L") | 0V("L") | 3V("H") | 3V("H") | 3V("H") | 0V("L") | 3V("H") | 0V("L") | 0V("L") | 0V("L") | 3V("L") | 0V("L") |
|       | IC507  |   | IC505   |     |  |       |  |       |       |       |       |         |         |         |         |         |         |         |         |         |         |         |         |
|       | PIN 1  | PIN 2   | PIN 5   |     |  |       |  |       |       |       |       |         |         |         |         |         |         |         |         |         |         |         |         |
|       | 0V("L")  | 0V("L")   | 3V("H") |     |  |       |  |       |       |       |       |         |         |         |         |         |         |         |         |         |         |         |         |
|       | 3V("H")  | 3V("H")   | 0V("L") |     |  |       |  |       |       |       |       |         |         |         |         |         |         |         |         |         |         |         |         |
|       | 3V("H")  | 0V("L")   | 0V("L") |     |  |       |  |       |       |       |       |         |         |         |         |         |         |         |         |         |         |         |         |
|       | 0V("L")  | 3V("L")   | 0V("L") |     |  |       |  |       |       |       |       |         |         |         |         |         |         |         |         |         |         |         |         |
|       | 6,8  | SAME AS PIN 61 OF IC501 SHOWN ABOVE.<br>SAMPLE WAVEFORM: (AP)   |         |     |  |       |  |       |       |       |       |         |         |         |         |         |         |         |         |         |         |         |         |
|       | 7  | 0 (GROUND).   |         |     |  |       |  |       |       |       |       |         |         |         |         |         |         |         |         |         |         |         |         |
| 9     | SAME AS PIN 1 OF IC504 SHOWN ABOVE.  |   |         |     |  |       |  |       |       |       |       |         |         |         |         |         |         |         |         |         |         |         |         |
| 10    | SAME AS PIN 55 OF IC501.<br>REVERSAL OF PIN 11 OF IC505.<br>SAMPLE WAVEFORM: (BC)  |   |         |     |  |       |  |       |       |       |       |         |         |         |         |         |         |         |         |         |         |         |         |
| 11    | 0.<br>(ALTERNATE 0 AND 3.0 WHEN TUNING KNOB TURNED. REVERSAL OF PIN 10 OF THIS IC IC505 AND PIN 55 OF IC501.<br>SAMPLE WAVEFORM: (BC)  |   |         |     |  |       |  |       |       |       |       |         |         |         |         |         |         |         |         |         |         |         |         |
| 12    | SAME AS PIN 1 OF IC504 AND PIN 9 OF IC505.   |   |         |     |  |       |  |       |       |       |       |         |         |         |         |         |         |         |         |         |         |         |         |
| 13    | SAME AS PIN 5 OF THIS IC IC505 AND PIN 3 OF IC507.   |   |         |     |  |       |  |       |       |       |       |         |         |         |         |         |         |         |         |         |         |         |         |
| 14    | 3.0 (B+).  |   |         |     |  |       |  |       |       |       |       |         |         |         |         |         |         |         |         |         |         |         |         |

| IC    | PIN | AM   | FM | AIR |
|-------|-----|--|----|-----|
| IC506 | 1   | SAME AS PIN 4 OF IC502 AND PIN 1 OF IC505.   |    |     |
|       | 2   | 0.<br>SAME AS PIN 5 OF IC506 AND PIN 4 OF IC507.   |    |     |
|       | 3   | 0.<br>SAME AS PIN 3 OF IC11.<br>SAMPLE WAVEFORM: (BH)  |    |     |
|       | 4   | 0.<br>SAME AS PIN 1 OF IC11.<br>WHEN AM, FM, AIR KEYED IN;<br>SAMPLE WAVEFORMS: (BH) AND (BI)                                  |    |     |
|       | 5   | SAME AS PIN 2 OF THIS IC IC506 AND PIN 4 OF IC507.   |    |     |
|       | 6   | SAME AS PIN 3 OF IC502, PIN 2 OF IC505 AND PIN 8 OF THIS IC506.  |    |     |
|       | 7   | 0 (GROUND).  |    |     |
|       | 8   | SAME AS PIN 3 OF IC502, PIN 2 OF IC505 AND PIN 6 OF THIS IC506.  |    |     |
|       | 9   | SAME AS PIN 2 OF IC502 AND PIN 12 OF THIS IC506.   |    |     |
|       | 10  | 0.<br>(1. WHEN AM OR AIR KEYED IN;<br>SAMPLE WAVEFORM: (BJ)<br>2. WHEN FM KEYED IN:<br>ALWAYS 0V<br>3. SAME FOR PIN 3 OF IC6.) |    |     |
|       | 11  | 0.<br>(WHEN AIR, FM, AM AND a1-a8 KEYED IN;<br>SAMPLE WAVEFORM: (BJ)<br>SAME FOR PIN 3 OF IC4.                                 |    |     |
|       | 12  | 0. SAME FOR PIN 2 OF IC502.<br>(WHEN AIR, FM, AM AND a1-a8 KEYED IN;<br>SAMPLE WAVEFORM: (BJ)                                  |    |     |
|       | 13  | SAME AS PIN 4 OF IC502 AND PIN 1 OF THIS IC506.  |    |     |
|       | 14  | 3.0 (B+).  |    |     |

AM MODE: W: WIDE ON, N: NARROW ON, SF: SYNC OFF, SN: SYNC ON, U: USB ON, L: LSB/CW ON

| IC    | PIN                         | AM   | FM        | AIR                 |
|-------|-----------------------------|--|-----------|---------------------|
| IC507 | 1                           | 0 OR 3.0 DEPENDING UPON STOP POSITION OF TUNING KNOB.<br>SAME AS PINS 3 AND 9 OF IC504.<br>REVERSAL OF PIN 2 OF THIS IC507.  |           |                     |
|       | 2                           | 3.0 OR 0 DEPENDING UPON STOP POSITION OF TUNING KNOB.<br>SAME AS PINS 5 AND 11 OF IC504.<br>REVERSAL OF PIN 1 OF THIS IC507. |           |                     |
|       | 3                           | SAME AS PINS 5 AND 13 OF IC505.  |           |                     |
|       | 4                           | 0. (ALL MODES).<br>SAME AS PINS 2 AND 5 OF IC506.  |           |                     |
|       | 5                           | 0. (GROUND).   |           |                     |
|       | 6                           | 0.4 (ALL BANDS).<br>SAME AS PINS 2 AND 5 OF IC506.   |           |                     |
|       | 7                           | 0. (GROUND).   |           |                     |
|       | 8                           | 0. (ALL BANDS).<br>SAME AS PIN 5 OF IC501 AND PIN 6 OF IC502.  |           |                     |
|       | 9                           | 0. (GROUND).   |           |                     |
|       | 10, 12                      | 0. (ALL BANDS).<br>1. WHEN BANDS, AM MODES, MEMORY AND TEN KEYS ARE KEYED IN, "L" STATE CHANGES TO "H" (3.0).<br>2. IC507    |           |                     |
|       |                             | PIN 1  | PIN 2     | PIN 10 AND 12       |
|       |                             | 3.0("H")   | 0 ("L")   | 3.0("H") OR 0 ("L") |
|       |                             | 0 ("L")  | 3.0("H")  | 3.0("H")            |
|       |                             | 0 ("L")  | 0 ("L")   | 3.0("H")            |
|       | 3.0("H")                    | 3.0("H")   | 3.0("H")  |                     |
| 11    | 0. (DATA SIGNAL FOR PLL'S). |  |           |                     |
| 13    | SAME AS COLLECTOR OF Q504.  |  |           |                     |
| 14.   | 3.0 (B+).                   |  |           |                     |
| IC601 | 1                           | 2.3  | 2.3       | 2.3                 |
|       | 2                           | 0.1  | 0.1       | 0.1                 |
|       | 3                           | SN,U,L: 1.8<br>W,N,SF: 0   | 1.8       | 0                   |
|       | 4                           | SN: 2.9<br>SF,U,L: 0   | 0.1       | 2.9                 |
|       | 5                           | NOT USED.  | NOT USED. | NOT USED.           |
|       | 6                           | 0(GROUND)  | 0(GROUND) | 0(GROUND)           |
|       | 7                           | 2.15   | 2.15      | 2.15                |
|       | 8                           | 2.35   | 2.35      | 2.35                |
|       | 9                           | 0(GROUND)  | 0(GROUND) | 0(GROUND)           |
|       | 10                          | NOT USED.  | NOT USED. | NOT USED.           |
|       | 11                          | 2.85   | 2.85      | 2.85                |
|       | 12                          | NOT USED.  | NOT USED. | NOT USED.           |
|       | 13                          | W,N: 1.2<br>U,L: 0.5<br>SN : 0.7   | 0.65      | 1.2                 |
|       | 14                          | 2.95   | 2.95      | 2.95                |
|       | 15                          | NOT USED.  | NOT USED. | NOT USED.           |
|       | 16                          | NOT USED.  | NOT USED. | NOT USED.           |
|       | 17                          | NOT USED.  | NOT USED. | NOT USED.           |
|       | 18                          | 2.65   | 2.65      | 2.65                |
|       | 19                          | 2.95   | 2.95      | 2.95                |
|       | 20                          | 2.45   | 2.45      | 2.45                |

| OTHER POINTS                 | AM   | FM                       | AIR  |
|------------------------------|--|--------------------------|--|
| VCO OUTPUT OF X601 (TO IC10) | SN,U,L;<br>3Vp-p SIGNAL OF 3.64MHz   | 3Vp-p SIGNAL OF 3.64MHz  | 1.3Vp-p SIGNAL OF 3.64MHz  |
| PSN                          | 1.0  | 1.0                      | 1.0  |
|                              | 2  | 1.0                      | 1.0  |
|                              | 3  | 3.0                      | 3.0  |
|                              | 4  | 1.35                     | 1.35   |
|                              | 5  | 0.45                     | 0.45   |
|                              | 6  | 0(GROUND)                | 0(GROUND)  |
|                              | 7  | 0(GROUND)                | 0(GROUND)  |
|                              | 8  | 3.0                      | 3.0  |
|                              | 9  | 1.0                      | 1.0  |
| OUTPUT OF L19 TO IC5         | AT 150kHz:<br>70mVp-p SINE OF 50,370.67kHz.<br>AT 29,999.9kHz:<br>70mVp-p SINE OF 50,345.57kHz | 0                        | AT 116MHz:<br>55mVp-p SINE OF 46,605.66kHz<br>AT 136MHz:<br>60mVp-p SINE OF 46,605.66kHz |
| OUTPUT OF X3 TO Q5           | 250mVp-p SINE OF 55,390kHz.<br>SAME FOR "S" OF Q5.   | 0<br>SAME FOR "S" OF Q5. | 250mVp-p SINE OF 55,390kHz.<br>SAME FOR "S" OF Q5.                                       |

SAMPLE WAVEFORMS:

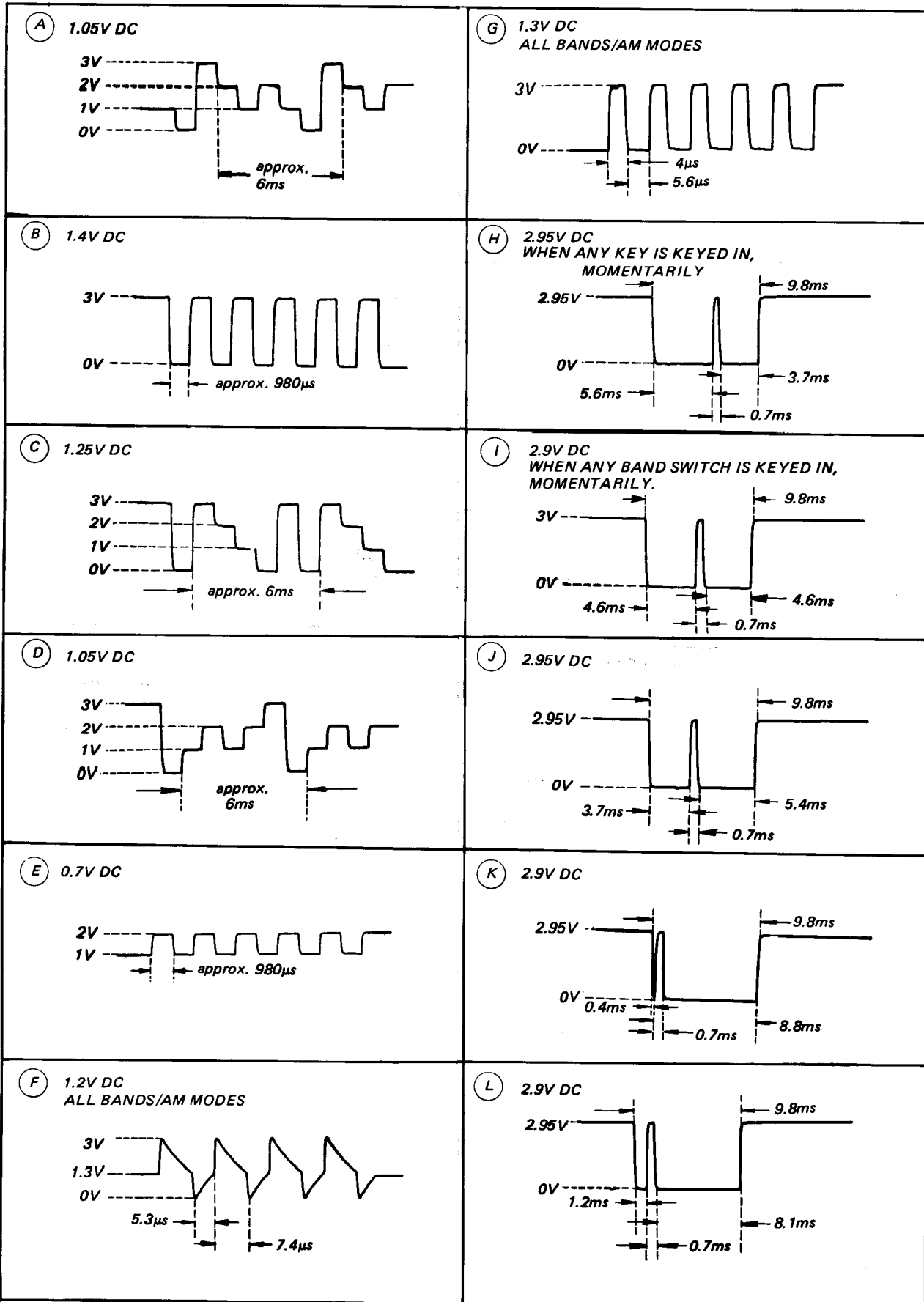

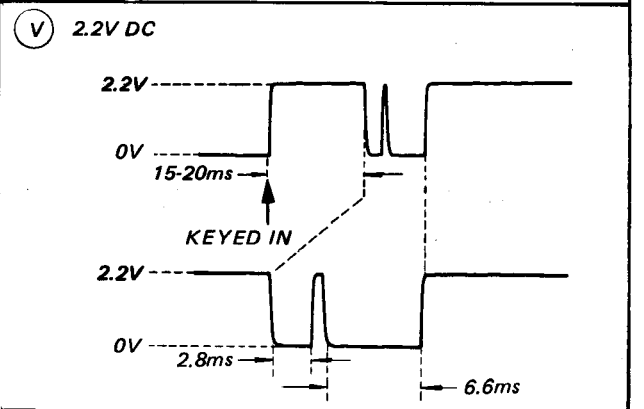
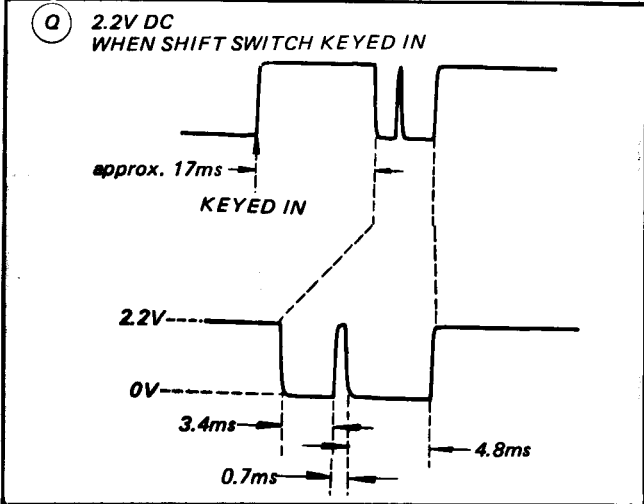
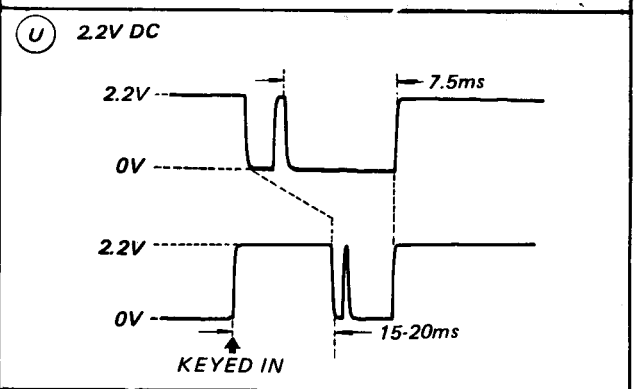
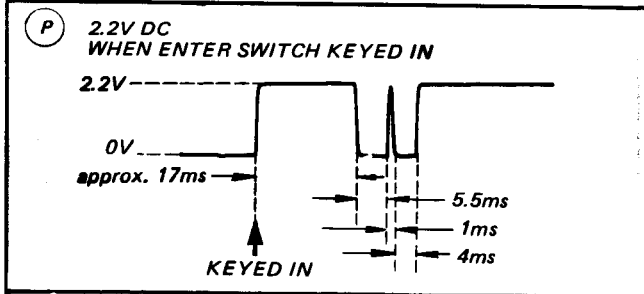
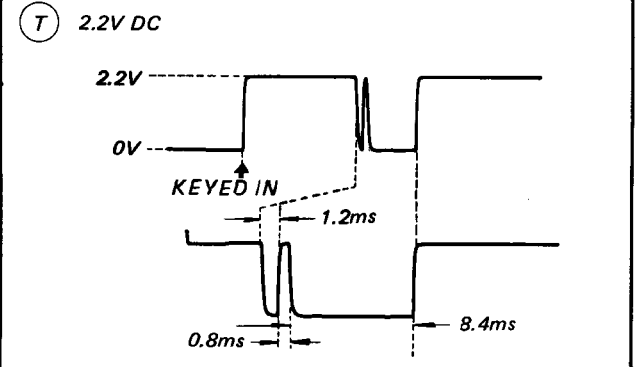
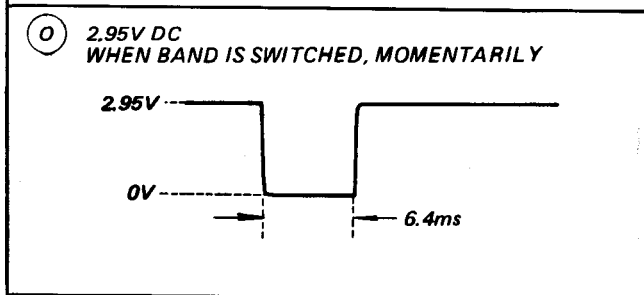
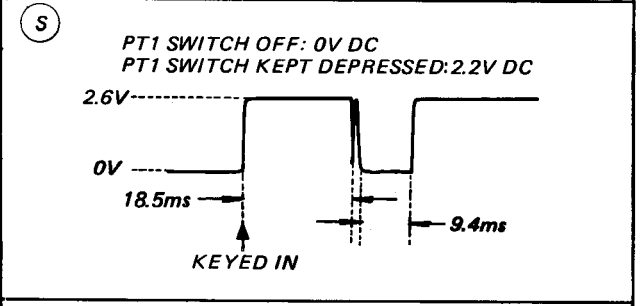
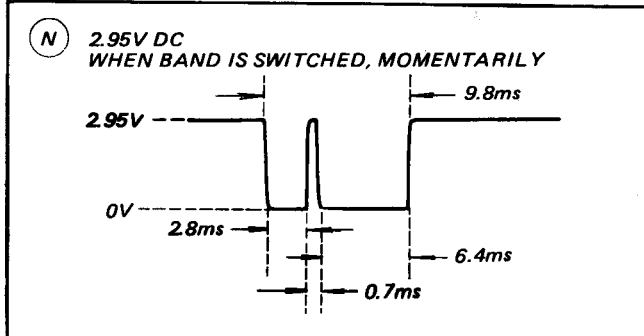
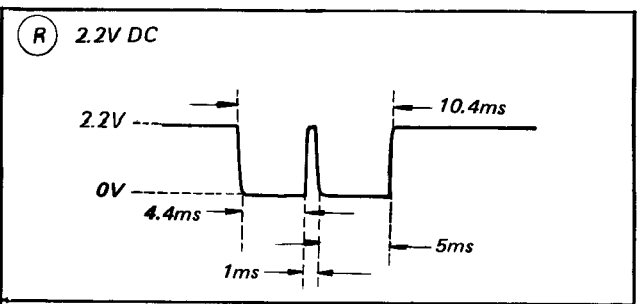
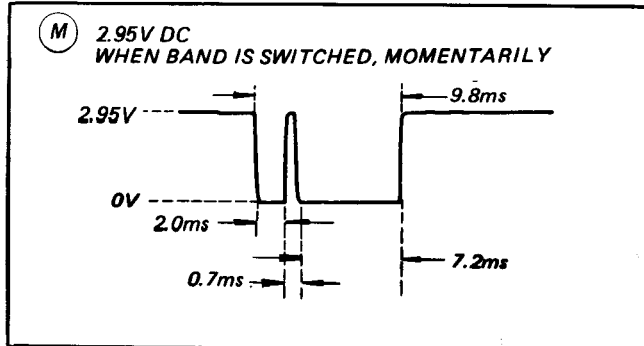

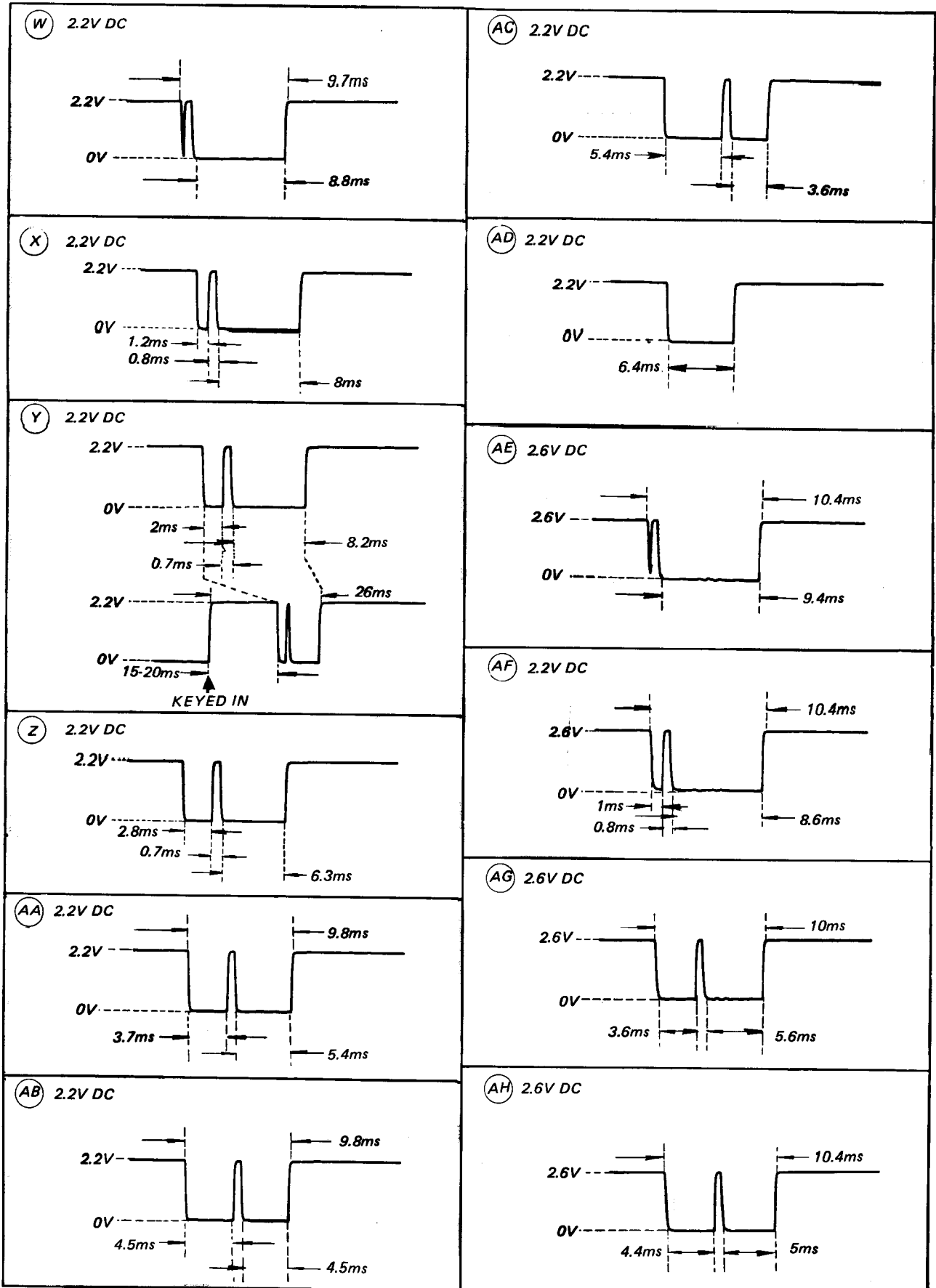

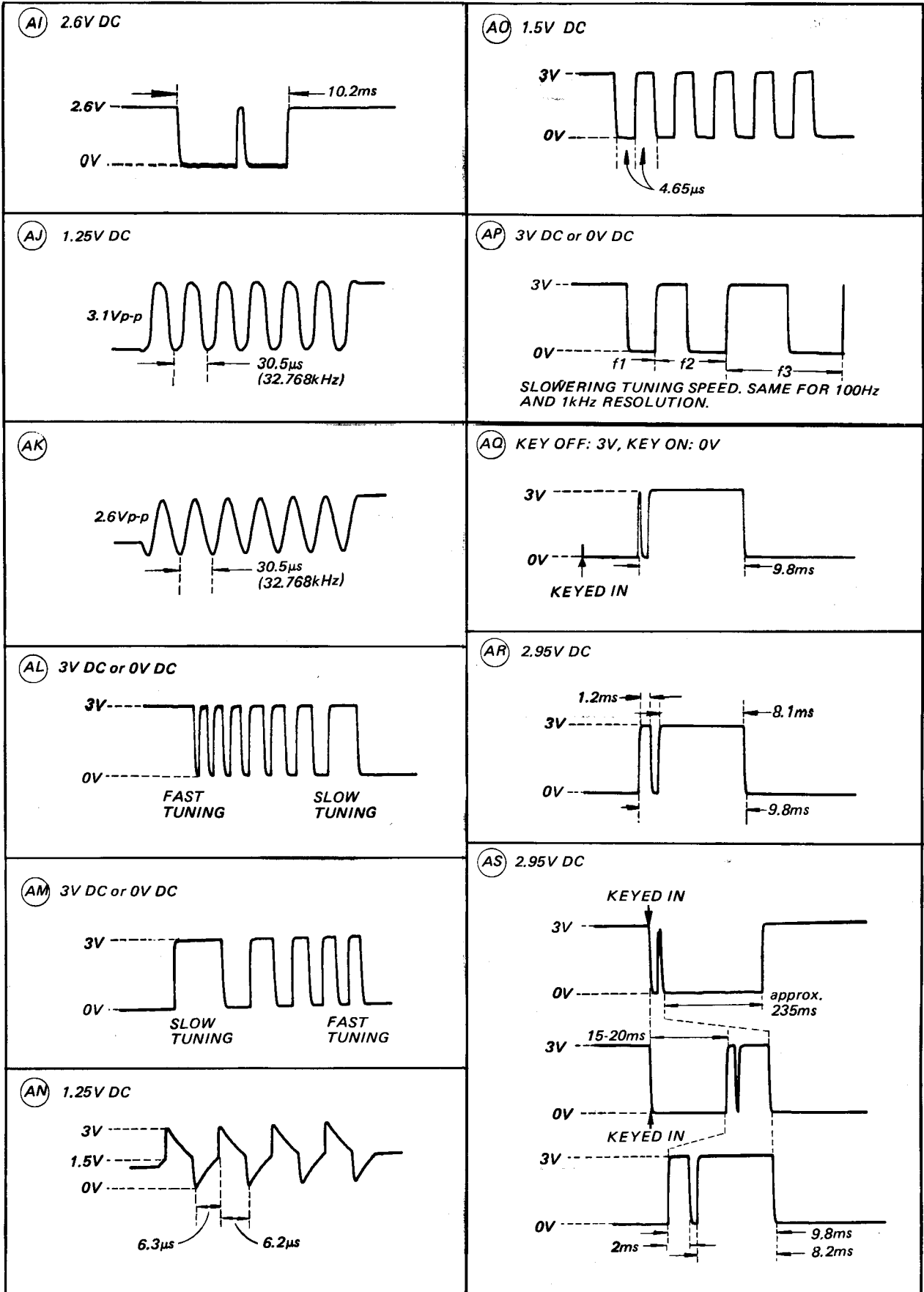

(AT) 2.95V DC

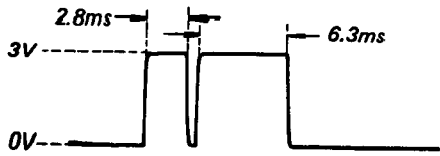

(AU) 2.95V DC

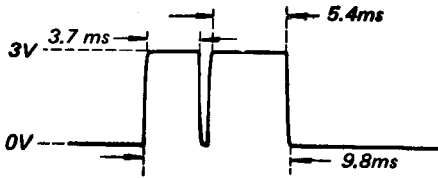

(AV) 2.95V DC

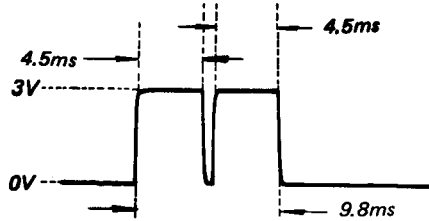

(AW) 2.95V DC

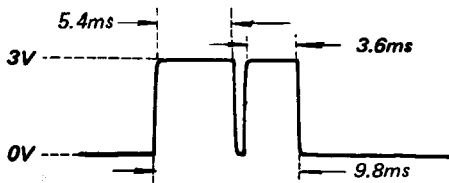

(AX) 2.95V DC

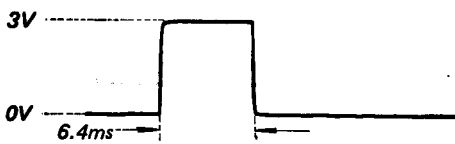

(BA) 3V DC OR 0V DC

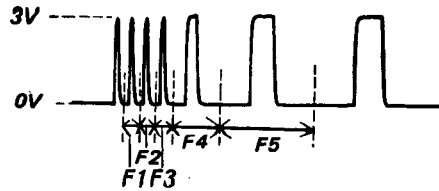

FAST TUNING SLOW TUNING.  
FIGURE ON LCD DISPLAY  
SUCCESSIVELY CHANGES DURING EACH  
DURATION F1 THROUGH F5, ETC.

(BB) 0V DC  
WHEN TUNING KNOB IS TURNED

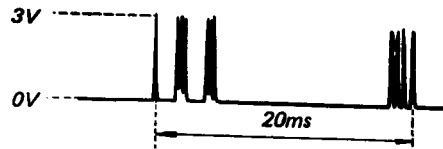

(BC) 3V DC OR 0V DC  
WHEN TUNING KNOB IS TURNED IN BOTH  
FREQUENCY AND TIMER SETTINGS.

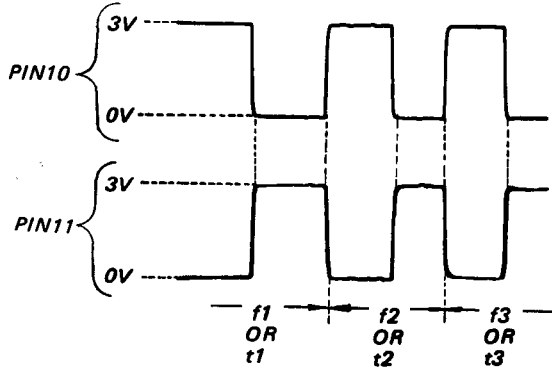

(BD) 0V DC  
WHEN AM OR AIR SWITCH IS PRESSED,  
MOMENTARILY TWO PULSES.



(BE) 0V DC  
WHEN AM SWITCH IS PRESSED TWICE OR a1  
THROUGH d8 SWITCH IS PRESSED ONCE,  
MOMENTARILY ONE PULSE.

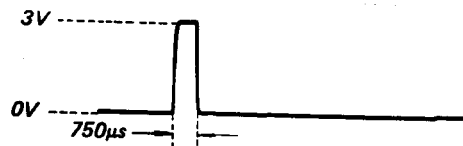



(BF) 0V DC  
 WHEN BAND SWITCH IS PRESSED INITIALLY,  
 MOMENTARILY TWO PULSES.

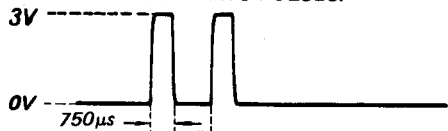

FM: 1.35ms AIR, AM: 3.4ms  
 AIR, AM: 3.4ms

WHEN EACH BAND SWITCH IS PRESSED TWICE,  
 WAVEFORM CHANGES TO (BE).

(BG) 0V DC  
 WHEN AM OR AIR SWITCH IS KEYED IN  
 INITIALLY, MOMENTARILY FOUR PULSES.

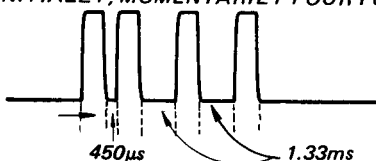

WHEN BAND IS CHANGED TO FM, WAVEFORM  
 CHANGES TO (BF). WHEN AIR IS PRESSED  
 TWICE, WAVEFORM CHANGES TO (BE).  
 WHEN AM IS PRESSED TWICE, WAVEFORM  
 CHANGES TO (BF)

(BH) 0V DC

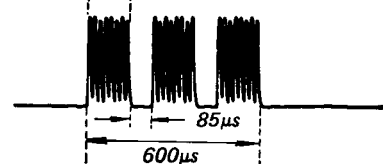
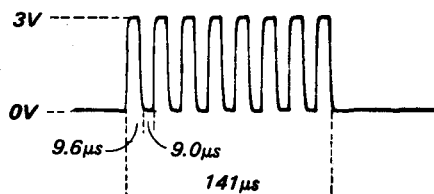

AIR: 3.3ms  
 FM: 2.1ms  
 AM: 4.1ms

WHEN AM SWITCH PRESSED TWICE, RIGHT-SIDE  
 THREE PULSE GROUP DISSAPPEARS.

IN SCAN START/STOP MODE, LEFT-SIDE THREE  
 PULSE GROUP ONLY FLICKERS.

(BI) 0V DC  
 WHEN AM OR AIR SWITCH IS KEYED AFTER  
 POWER ON, MOMENTARILY.

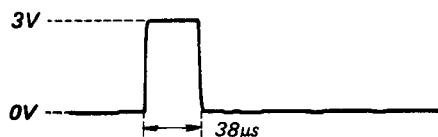

WHEN FM KEYED IN:  
 UNCHANGED 0V DC

SEGMENTS AND COMMONS OF LIQUID - CRYSTAL DISPLAY PANEL

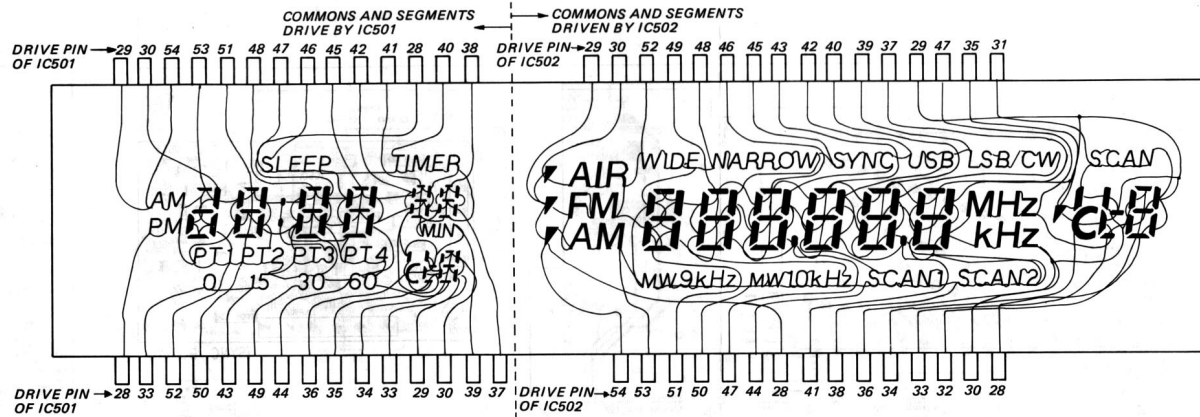

Fig. 1

NOTE: DOUBLED PIN NUMBERS ARE CONNECTED BY PRINTED CIRCUIT BOARD PATTERNS AS SHOWN IN MOUNTING DIAGRAM.

— : SEGMENT GROUPS DRIVEN BY IC501 AND IC502.  
 — : COMMON GROUPS DRIVEN BY IC501 AND IC502.

8-BIT INPUT GROUPING

KEY-INPUT SWITCHES ARE DIVIDED INTO 9(NINE) GROUPS AS SHOWN IN FIG. 2 BELOW TO UTILIZE 8-BIT PRIORITY ENCODER IC503 AND AS OUTLINED FOR SOME VOLTAGES/WAVEFORM SAMPLES. ALSO REFER TO LOWER-RIGHTHAND CORNER OF SCHEMATIC DIAGRAM.

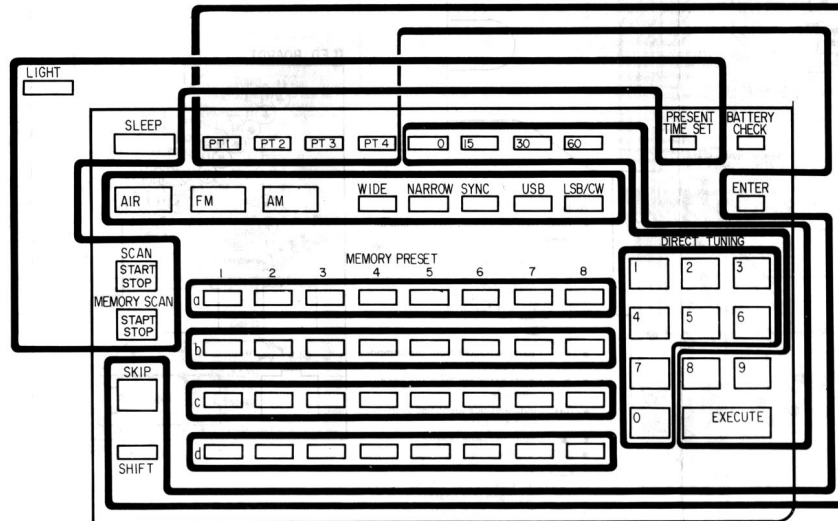

Fig. 2









4-2. SCHEMATIC DIAGRAM

See pages 36-58 for detailed voltages and waveforms.

ICF-2001D/2010 ICF-2001D/2010

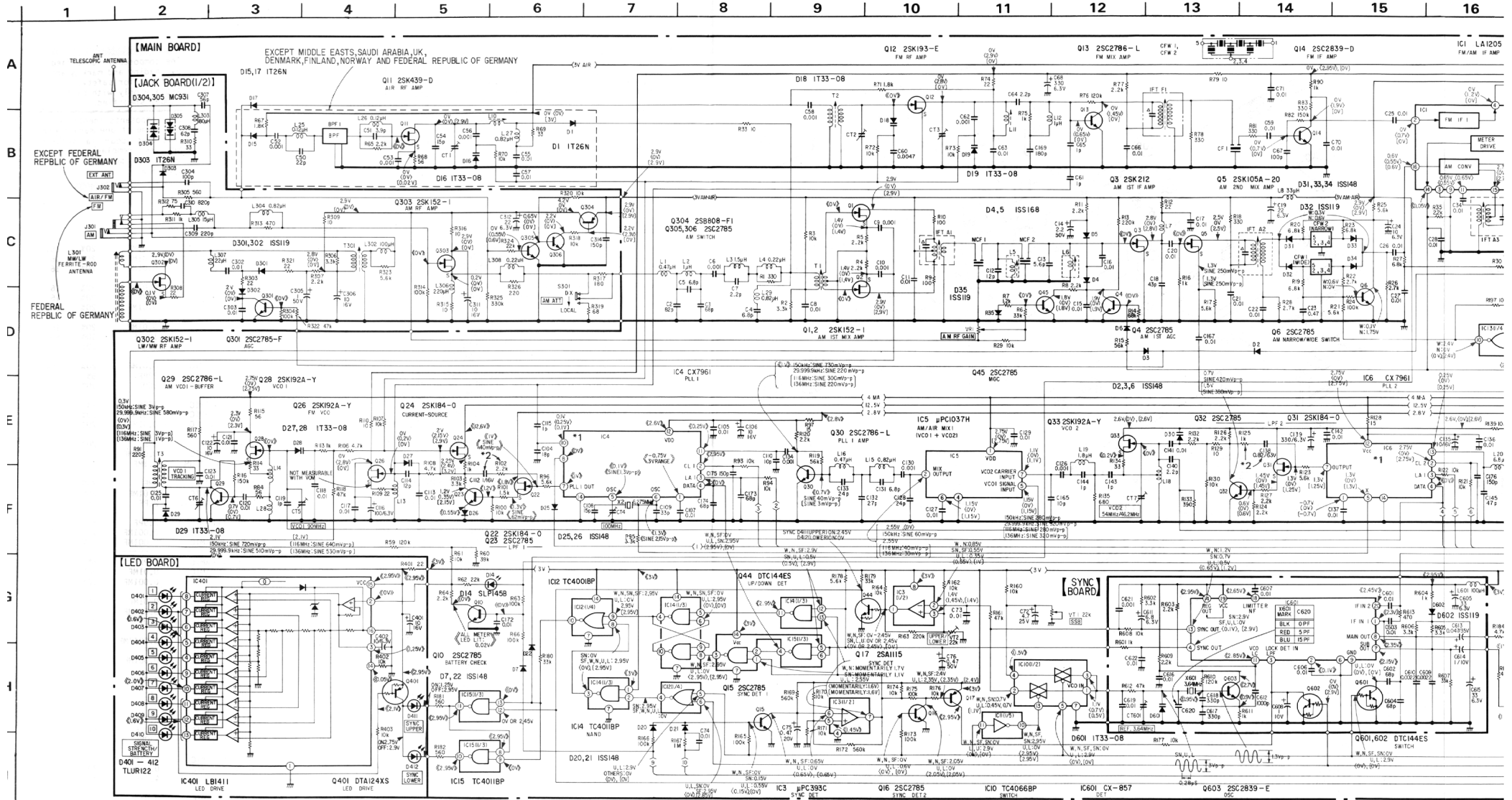

- Note:**
- All capacitors are in  $\mu\text{F}$  unless otherwise noted.  $\text{pF} = \mu\text{M}\text{F}$  50 WV or less are not indicated except for electrolytics and tantalums.
  - All resistors are in  $\Omega$  and 1/5W or less unless otherwise specified.

• Switch

| Ref. No. | Switch           | Position |
|----------|------------------|----------|
| S1       | TONE             | HIGH     |
| S301     | AM ATT           | DX       |
| S302     | MAIN POWER       | OFF      |
| S501     | MANUAL TUNE MODE | LOCK     |
| S502     | POWER            | OFF      |

- : adjustment for repair.
- Power voltages are 3.0 V and 4.5 V and fed to respective circuit boards from regulated power supplies. Voltages are dc with respect to ground in no-input-signal mode unless otherwise specified with a VOM (50 k $\Omega$ /V). Voltage variations may be noted due to normal production tolerances.

- no mark : AM  
[ ] : AIR  
<< >> : FM  
<<< >>> : COMMON SF : SYNC OFF
- Waveforms are taken from ground in no-input-signal mode by using oscilloscope. Voltage variations may be noted due to normal production tolerances.

\*1 Be sure to see Servicing note on page 86 (b) when replacing IC4 and/or IC6.

\*2 See page 86, since the capacities and the values are different by the type of IC4 and

4-2. SCHEMATIC DIAGRAM

See pages 36-58 for detailed voltages and waveforms.

ICF-2001D/2010 ICF-2001D/2010

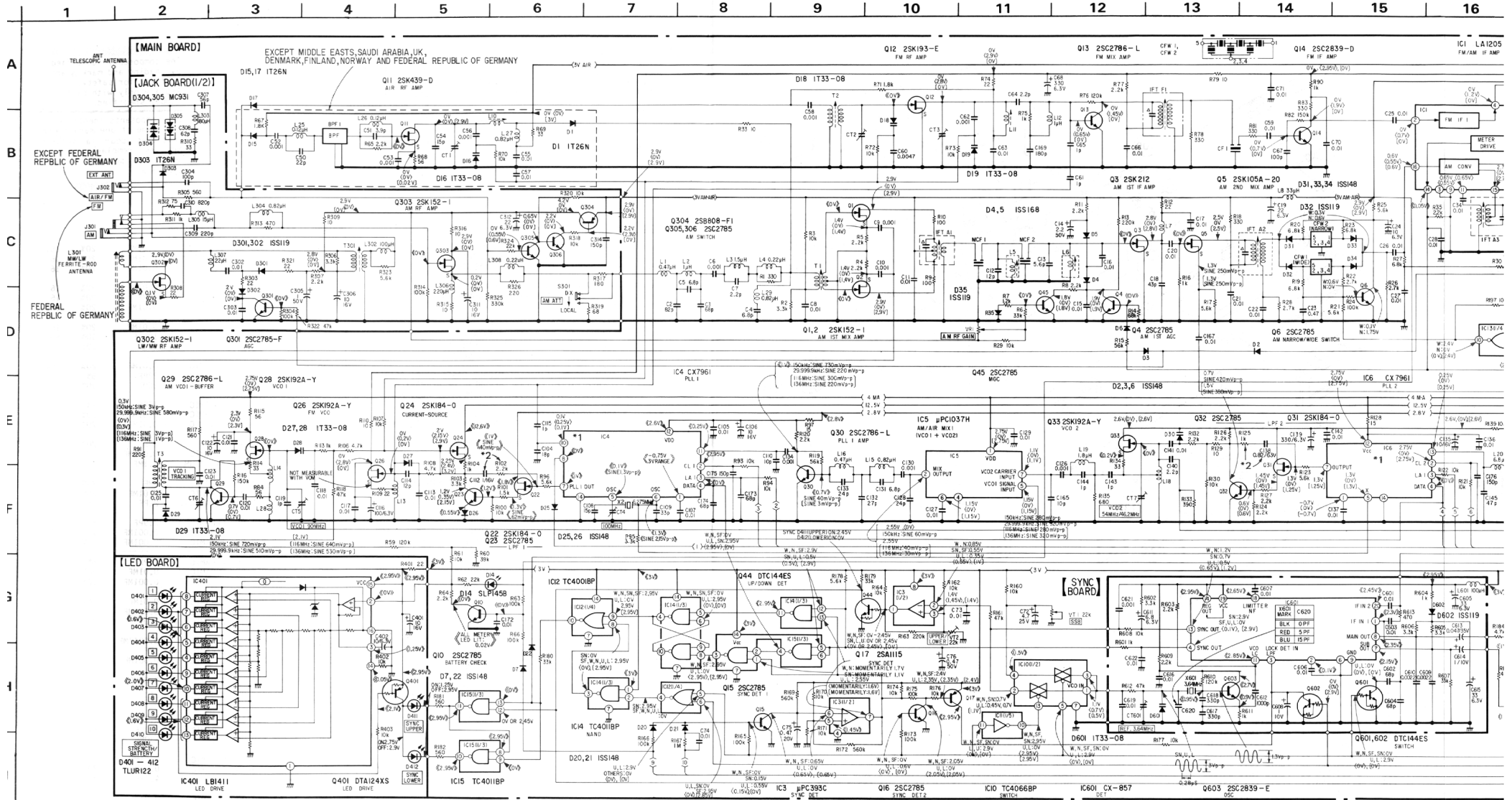

- Note:**
- All capacitors are in  $\mu\text{F}$  unless otherwise noted.  $\text{pF} = \mu\text{M}\text{F}$  50 WV or less are not indicated except for electrolytics and tantalums.
  - All resistors are in  $\Omega$  and 1/5W or less unless otherwise specified.

• Switch

| Ref. No. | Switch           | Position |
|----------|------------------|----------|
| S1       | TONE             | HIGH     |
| S301     | AM ATT           | DX       |
| S302     | MAIN POWER       | OFF      |
| S501     | MANUAL TUNE MODE | LOCK     |
| S502     | POWER            | OFF      |

- : adjustment for repair.
- Power voltages are 3.0 V and 4.5 V and fed to respective circuit boards from regulated power supplies. Voltages are dc with respect to ground in no-input-signal mode unless otherwise specified with a VOM (50 k $\Omega$ /V). Voltage variations may be noted due to normal production tolerances.

- no mark : AM  
[ ] : AIR  
<< >> : FM  
<<< >>> : COMMON SF : SYNC OFF
- Waveforms are taken from ground in no-input-signal mode by using oscilloscope. Voltage variations may be noted due to normal production tolerances.

\*1 Be sure to see Servicing note on page 86 (b) when replacing IC4 and/or IC6.

\*2 See page 86, since the capacities and the values are different by the type of IC4 and

19 20 21 22 23 24 25 26 27 28 29 30 31 32 33 34

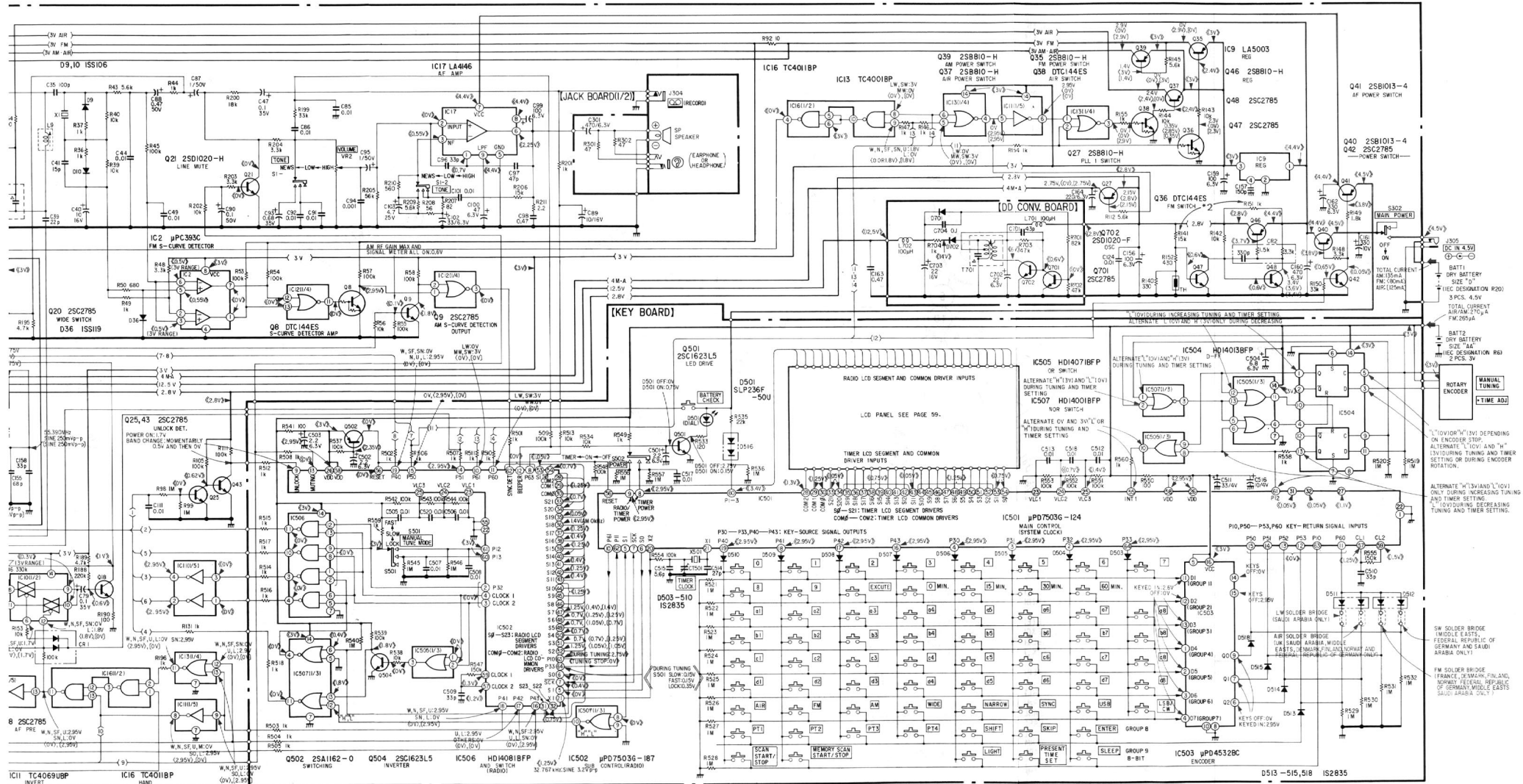



SECTION 5  
EXPLODED VIEWS AND PARTS LIST

• Semiconductor lead layouts

|   |                   |                                       |                                     |
|---|-------------------|---------------------------------------|-------------------------------------|
| CX-857<br>CX-7961<br>HD14001BP<br>HD14001BFP<br>HD14006BP<br>HD14069UBP<br>HD14071BFP<br>HD14081BFP<br>LA1205<br>LB1411<br>TC4013BP<br>μPC393C<br>μPD4532BC | <p>2SC1623</p>    | 1SS106<br>1SS119<br>1SS168<br>HZ12B3L | <p>cathode<br/>anode</p>            |
| <p>LA4146<br/>LA5003<br/>μPC1037H</p>   | <p>2SB1013</p>    | 1T26N                                 | <p>cathode<br/>anode</p>            |
| <p>μPD7503G-124<br/>μPD7503G-187</p>  | <p>2SK105A-30</p> | 1T33                                  | <p>anode<br/>cathode</p>            |
| 2SA1027R  | <p>2SK152</p>     | TLUR122                               | <p>anode<br/>cathode</p>            |
| 2SB808<br>2SC2839<br>2SC2839-D<br>2SD1012-2<br>2SD1012-F2<br>DTA124XS<br>DTC144ES   | <p>2SK184</p>     | 1S2835                                | <p>anode<br/>cathode</p>            |
| 2SB811<br>2SC2785<br>2SC2786-L  | <p>2SK192A</p>    | SLP145B                               | <p>long anode<br/>short cathode</p> |
|   | <p>MC931</p>      | SLP236F-50U                           | <p>long anode<br/>short cathode</p> |

NOTE:

- The mechanical parts with no reference number in the exploded views are not supplied.
- Items marked "★" are not stocked since they are seldom required for routine service. Some delay should be anticipated when ordering these items.
- The construction parts of an assembled part are indicated with a collation number on the remark column.

The components identified by shading and mark are critical for safety. Replace only with part number specified.

Les composants identifiés par une trame et une marque sont critiques pour la sécurité. Ne les remplacer que par une pièce portant le numéro spécifique.

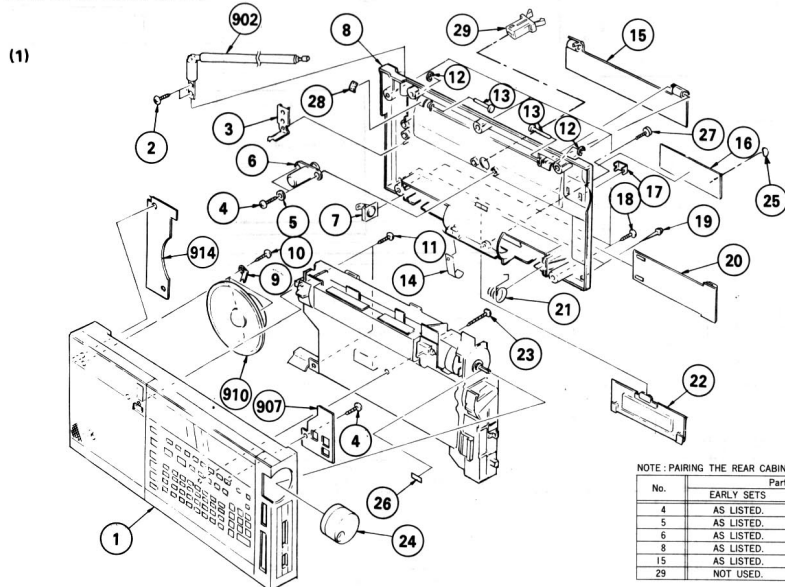

NOTE: PAIRING THE REAR CABINET AND STAND

| No. | EARLY SETS | LATER SETS |
|-----|------------|------------|
| 4   | AS LISTED. | NOT USED.  |
| 5   | AS LISTED. | NOT USED.  |
| 6   | AS LISTED. | NOT USED.  |
| 8   | AS LISTED. | AS LISTED. |
| 15  | AS LISTED. | AS LISTED. |
| 29  | NOT USED.  | AS LISTED. |

| No. | Part No.      | Description   | REMARKS | No. | Part No.      | Description   | REMARKS |
|-----|---------------|---|---------|-----|---------------|---|---------|
| 1   | X-3894-511-1  | (US,Canadian)...CABINET ASSY, FRONT   |         | 16. | 3-703-264-12  | (EXCEPT US,Canadian)..LABEL, SERIAL NUMBER  |         |
|     | X-3894-512-1  | (MIDDLE EASTS AND SAUDI ARABIA)   |         |     | 3-887-286-01  | (EXCEPT US,Canadian,AUS)  |         |
|     | X-3894-513-1  | (E(EXCEPT MIDDLE EASTS,SAUDI ARABIA),AUS, AEP(EXCEPT DENMARK,FINLAND,NORWAY,FEDERAL REPUBLIC OF GERMANY))...CABINET ASSY, FRONT |         |     | 3-894-572-01  | (AEP(EXCEPT DENMARK,FINLAND,NORWAY, FEDERAL REPUBLIC OF GERMANY),AUS,E(EXCEPT MIDDLE EASTS,SAUDI ARABIA))...LABEL, MODEL NUMBER |         |
|     | X-3894-514-1  | (UK,AEP(DENMARK,FINLAND,NORWAY))...CABINET ASSY, FRONT  |         |     | 3-894-573-01  | (E(MIDDLE EASTS,SAUDI ARABIA),AEP(DENMARK,FINLAND,NORWAY,FEDERAL REPUBLIC OF GERMANY),UK)...LABEL, MODEL NUMBER                 |         |
|     | X-3894-515-1  | (AEP(FEDERAL REPUBLIC OF GERMANY))...CABINET ASSY, FRONT  |         |     | 3-894-574-01  | (US,Canadian).....LABEL, MODEL NUMBER   |         |
| 2   | 7-682-547-09  | SCREW +B 3X6  |         | 17  | 3-894-509-01  | HOOK, BELT  |         |
| 3   | 3-894-516-01  | TERMINAL BOARD, ANTENNA   |         | 18  | 7-685-148-19  | SCREW +PTP 3X12   |         |
| 4   | 7-685-132-19  | (EARLY SETS)...SCREW +BTP 2.6X5 TYPE2 N-S   |         | 19  | 3-427-542-00  | STOPPER   |         |
| 5   | 7-688-002-11  | (EARLY SETS)...WASHER, 2.6 (MIDDLE)   |         | 20  | A-3635-189-A  | CARD ASSY, MENU   |         |
| 6   | 3-894-511-01  | (EARLY SETS)...LATCH, MAGNET  |         | 21  | 3-894-514-01  | TERMINAL (1), MINUS   |         |
| 7   | 3-894-513-01  | TERMINAL BOARD (1), PLUS  |         | 22  | X-3894-510-1  | BATTERY LID ASSY  |         |
| 8   | 3-894-552-02  | (EARLY SETS)...CABINET (REAR)   |         | 23  | 7-685-154-19  | SCREW +P 3X35 TYPE2 NON-SLIT  |         |
| 8   | 3-894-552-03  | (LATER SETS)...CABINET (REAR)   |         | 24  | X-3894-506-1  | KNOB ASSY, TUNING   |         |
| 9   | 3-571-320-00  | CLAMP, SP   |         | 25  | 3-701-400-01  | (AEP(FINLAND,DENMARK,NORWAY))...LABEL, NEMKO  |         |
| 10  | 7-685-646-71  | SCREW +BTP 3X8 TYPE2 IT-3   |         | 26  | *3-703-929-01 | SHEET, KNOB   |         |
| 11  | 7-685-146-19  | SCREW +BTP 3X8 TYPE2 N-S  |         | 27  | 7-685-147-19  | SCREW +BTP 3X10 TYPE2 N-S   |         |
| 12  | 7-624-105-04  | STOP RING 2.3, TYPE -E  |         | 28  | 3-839-642-01  | CUSHION (B)   |         |
| 13  | *3-894-508-01 | PIN, STAND  |         | 29  | 4-374-714-01  | (LATER SETS)...LATCH, STAND   |         |
| 14  | 9-911-816-01  | CLOTH, BATTERY DRAWER   |         | 902 | 1-501-331-11  | ANTENNA, TELESCOPIC   |         |
| 15  | A-3635-188-A  | (EARLY SETS)...STAND ASSY   |         | 907 | *1-614-275-11 | PC BOARD, LED   |         |
| 15  | 3-894-547-04  | (LATER SETS)...STAND  |         | 910 | 8-927-179-00  | SPEAKER UNIT (100F016)  |         |
|     |               |   |         | 914 | *A-3684-073-A | MOUNTED PCB, JACK   |         |

(2)

(3)

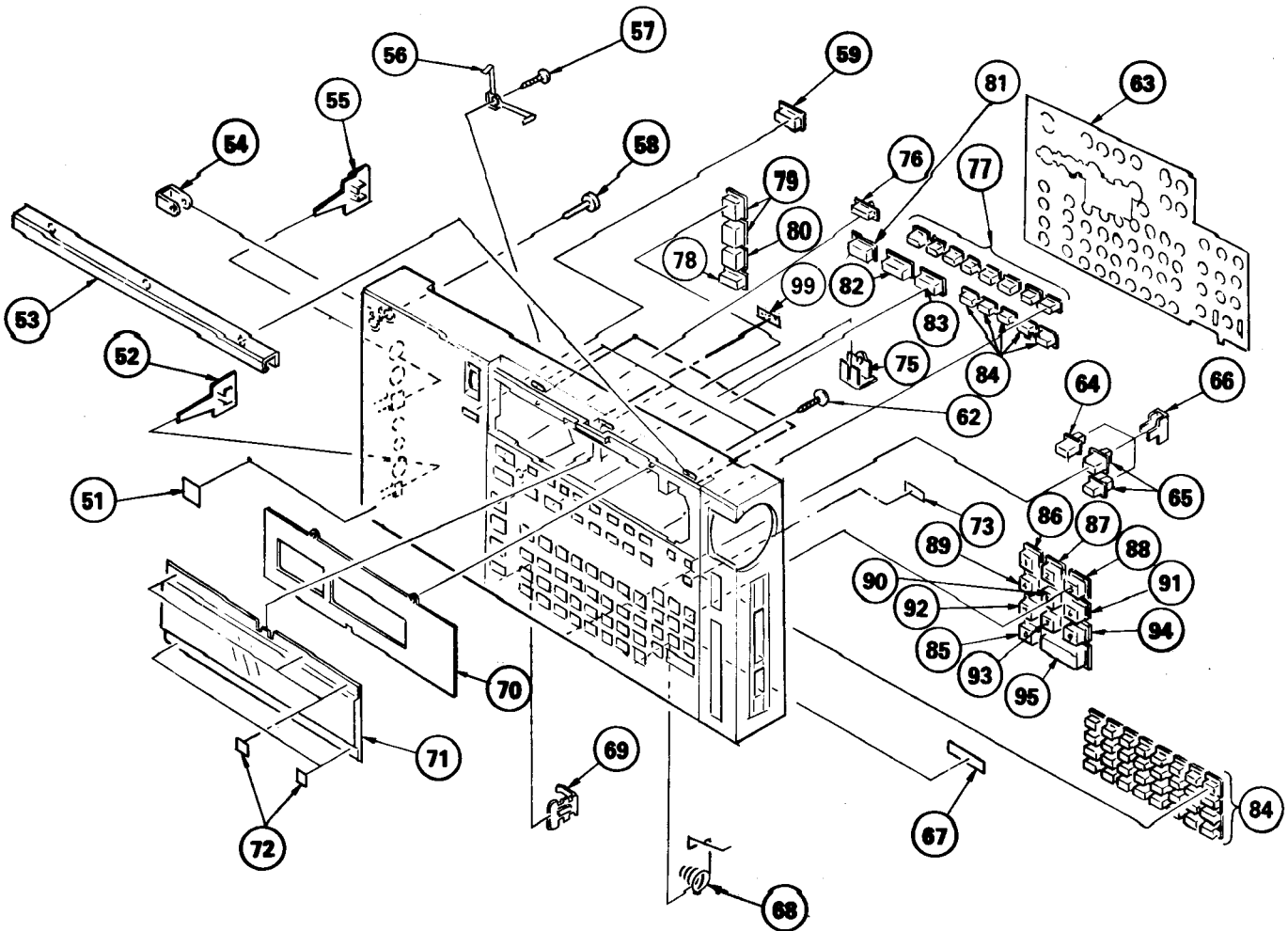

| No. | Part No.      | Description  | REMARKS |
|-----|---------------|--|---------|
| 51  | 3-703-708-01  | STICKER, SONY SYMBOL (18)  |         |
| 52  | 3-894-510-11  | (EXCEPT E(ASIA))...KNOB, ALC:GRN   |         |
| 53  | 3-894-534-01  | SASH, ORNAMENTAL   |         |
| 54  | 3-894-528-01  | HOOK (2), BELT   |         |
| 55  | 3-894-510-01  | KNOB, ALC:BLK  |         |
| 56  | 3-894-530-01  | SPRING   |         |
| 57  | 7-685-103-21  | SCREW +PTP 2X5   |         |
| 58  | 3-894-506-01  | PIN, BELT  |         |
| 59  | 3-894-589-01  | BUTTON, LIGHT  |         |
| 62  | 7-628-254-15  | SCREW +PS 2.6X6  |         |
| 63  | 3-894-517-01  | SHEET, BUTTON RETAINER   |         |
| 64  | 3-894-545-11  | BUTTON, 3 KEY (PRESENT TIME)   |         |
| 65  | 3-894-545-01  | BUTTON, 3 KEY (BATTERY CHECK,ENTER)  |         |
| 66  | *3-894-584-02 | COVER, KEY TOP   |         |
| 67  | 3-894-529-01  | LABEL, POLARITY  |         |
| 68  | 3-894-531-01  | SPRING   |         |
| 69  | 3-894-532-01  | PLATE, POLE, BATTERY   |         |
| 70  | 3-894-536-41  | (E(MIDDLE EASTS))..PLATE, INDICATION, LCD  |         |
|     | 3-894-536-51  | (E(SAUDE ARABIA))..PLATE, INDICATION, LCD  |         |
|     | 3-894-536-11  | (UK).....PLATE, INDICATION, LCD  |         |
|     | 3-894-536-21  | (AEP(FRANCE)).....PLATE, INDICATION, LCD   |         |
|     | 3-894-536-31  | (AEP(DENMARK,FINLAND,NORWAY))...PALATE, INDICATION                               |         |
|     | 3-894-536-01  | (E(EXCEPT MIDDLE EASTS, SAUDI-ARABIA), Canadian,US,AEP)...PLATE, INDICATION, LCD |         |

| No. | Part No.      | Description  | REMARKS |
|-----|---------------|--|---------|
| 71  | 3-894-535-01  | PLATE, TRANSPARENT   |         |
| 72  | 3-831-441-XX  | CUSHION, STOPPER   |         |
| 73  | 9-911-863-XX  | (US,Canadian,AEP,AUS,E(EXCEPT SAUDI ARABIA))...SPACER, PUSH BUTTON |         |
| 75  | *3-894-583-01 | LUG, GROUND  |         |
| 76  | 3-894-588-01  | BUTTON, SLEEP  |         |
| 77  | 3-894-590-01  | BUTTON, TIMER  |         |
| 78  | 3-894-591-01  | BUTTON, SHIFT  |         |
| 79  | 3-894-594-01  | BUTTON, START/STOP   |         |
| 80  | 3-894-594-11  | BUTTON, SKIP   |         |
| 81  | 3-894-598-01  | BUTTON, BAND (AIR)   |         |
| 82  | 3-894-598-11  | BUTTON, BAND (FM)  |         |
| 83  | 3-894-598-21  | BUTTON, BAND (AM)  |         |
| 84  | 3-894-539-02  | BUTTON, 32-KEY   |         |
| 85  | 3-894-596-01  | BUTTON, FIGURE (0)   |         |
| 86  | 3-894-596-11  | BUTTON, FIGURE (1)   |         |
| 87  | 3-894-596-21  | BUTTON, FIGURE (2)   |         |
| 88  | 3-894-596-31  | BUTTON, FIGURE (3)   |         |
| 89  | 3-894-596-41  | BUTTON, FIGURE (4)   |         |
| 90  | 3-894-596-51  | BUTTON, FIGURE (5)   |         |
| 91  | 3-894-596-61  | BUTTON, FIGURE (6)   |         |
| 92  | 3-894-596-71  | BUTTON, FIGURE (7)   |         |
| 93  | 3-894-596-81  | BUTTON, FIGURE (8)   |         |
| 94  | 3-894-596-91  | BUTTON, FIGURE (9)   |         |
| 95  | 3-894-595-01  | BUTTON, EXECUTE  |         |
| 99  | 3-839-640-00  | CUSHION  |         |

(3)

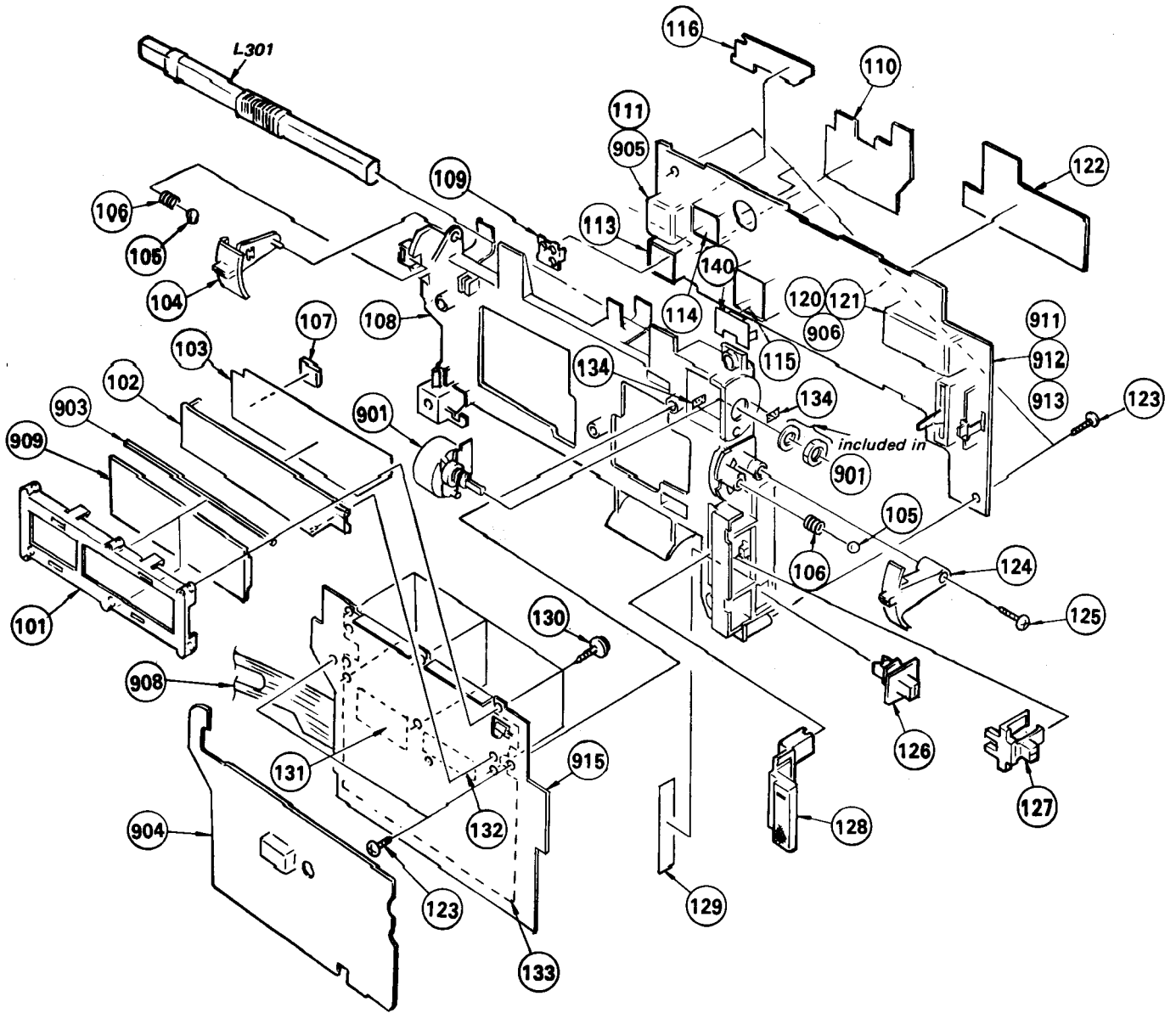

| No. | Part No.      | Description              | REMARKS |
|-----|---------------|--------------------------|---------|
| 101 | *3-894-502-01 | HOLDER, LCD              |         |
| 102 | 3-894-533-01  | PLATE, LIGHT GUIDE       |         |
| 103 | 3-894-515-01  | SHEET, REFLECTION        |         |
| 104 | 3-894-538-01  | KNOB, POWER              |         |
| 105 | 7-671-156-01  | BALL, STAINLESS          |         |
| 106 | 3-894-526-01  | SPRING, COMPRESSION      |         |
| 107 | 9-911-815-XX  | ABSORBER, VIBRATION (F)  |         |
| 108 | 3-894-550-01  | CHASSIS                  |         |
| 110 | *X-3894-515-1 | PLATE (N) ASSY, SHIELD   |         |
| 111 | *3-891-832-01 | CASE (A), SHIELD         |         |
| 113 | *3-894-521-01 | PLATE (D), SHIELD        |         |
| 114 | *3-894-520-01 | PLATE (C), SHIELD        |         |
| 115 | *3-894-518-01 | PLATE (A), SHIELD        |         |
| 116 | *X-3894-507-1 | PLATE (L) ASSY, SHIELD   |         |
| 120 | *3-894-519-01 | PLATE (B), SHIELD        |         |
| 121 | *3-894-580-01 | SHEET (B), INSULATING    |         |
| 122 | *X-3894-508-1 | PLATE (K) ASSY, SHIELD   |         |
| 123 | 7-685-146-19  | SCREW +BTP 3X8 TYPE2 N-S |         |
| 124 | 3-894-537-01  | KNOB, S.F.L              |         |
| 125 | 7-685-546-19  | SCREW +BTP 3X8           |         |
| 126 | 3-894-505-01  | KNOB, SELECTOR           |         |
| 127 | 3-894-543-01  | KNOB, TONE               |         |
| 128 | 3-894-507-01  | CONTROL, SLIDE           |         |

| No. | Part No.      | Description  | REMARKS |
|-----|---------------|--|---------|
| 129 | 3-894-585-01  | SHEET, CONTROL   |         |
| 130 | 7-687-204-21  | TOTSU PTPWH 2X6 NON-SLIT, TYPE2  |         |
| 131 | *X-3894-504-1 | PLATE (H) ASSY, SHIELD   |         |
| 132 | *X-3894-503-1 | PLATE (G) ASSY, SHIELD   |         |
| 133 | *X-3894-505-1 | PLATE (J) ASSY, SHIELD   |         |
| 134 | 3-894-593-01  | SHEET, KNOB  |         |
| 901 | 1-464-406-11  | ENCODER, ROTARY  |         |
| 903 | 1-535-550-11  | CONDUCTOR, CONNECTOR   |         |
| 904 | 1-570-071-11  | SWITCH, RUBBER KEY   |         |
| 905 | *1-614-273-11 | PC BOARD, DD CONVERTER   |         |
| 906 | *1-614-274-11 | PC BOARD, SYNC   |         |
| 908 | 1-614-279-11  | PC BOARD, FLEXIBLE   |         |
| 909 | 1-807-009-11  | DISPLAY PANEL, LIQUID CRYSTAL  |         |
| 911 | A-3660-544-A  | (E(EXCEPT MIDDLE EASTS SAUDI ARABIA),AEP (EXCEPT FEDERAL REPUBLIC OF GERMANY,NORWAY, DENMARK,FINLAND),AUS)...MOUNTED PCB, MAIN |         |
| 912 | A-3660-557-A  | (E(MIDDLE EASTS,SAUDI ARABIA),AEP(NORWAY, FINLAND,DENMARK),UK)...MOUNTED PCB MAIN  |         |
| 913 | *A-3660-559-A | (US,Canadian)...MOUNTED PCB, MAIN  |         |
| 915 | *A-3689-056-A | PC BOARD ASSY, KEY   |         |
| 140 | *3-895-102-01 | ((AEP FEDERAL REPUBLIC OF GERMANY)...CASE (Z), SHIELD  |         |

**NOTE:**

- Items marked "★" are not stocked since they are seldom required for routine service. Some delay should be anticipated when ordering these items.
- If there are two or more same circuits in a set such as a stereophonic machine, only typical circuit parts may be indicated and capacitors and resistors in other same circuits may be omitted.

**CAPACITORS:**

MF:μF, PF:μμF.

**RESISTORS**

- All resistors are in ohms.
- F : nonflammable

**COILS**

MMH : mH, UH : μH

**SEMICONDUCTORS**

In each case, U : μ, for example:  
 UA.... : μA..., UPA.... : μPA..., UPC.... : μPC,  
 UPD.... : μPD...

The components identified by shading and mark  are critical for safety. Replace only with part number specified.

Les composants identifiés par une trame et une marque  sont critiques pour la sécurité. Ne les remplacer que par une pièce portant le numéro spécifié.

ELECTRICAL PARTS

| Ref.No. | Part No.      | Description  |         |     |      |
|---------|---------------|--|---------|-----|------|
| 901     | 1-464-406-11  | ENCODER, ROTARY  |         |     |      |
| 902     | 1-501-331-11  | ANTENNA, TELESCOPIC  |         |     |      |
| 903     | 1-535-550-11  | CONDUCTOR, CONNECTOR   |         |     |      |
| 904     | 1-570-071-11  | SWITCH, RUBBER KEY   |         |     |      |
| 905     | *1-614-273-11 | PC BOARD, DD CONVERTER   |         |     |      |
| 906     | *1-614-274-11 | PC BOARD, SYNC   |         |     |      |
| 907     | *1-614-275-11 | PC BOARD, LED  |         |     |      |
| 908     | 1-614-279-11  | PC BOARD, FLEXIBLE   |         |     |      |
| 909     | 1-807-009-11  | DISPLAY PANEL, LIQUID CRYSTAL  |         |     |      |
| 910     | 8-927-179-00  | SPEAKER UNIT (100F016)   |         |     |      |
| 911     | A-3660-544-A  | (E(EXCEPT MIDDLE EASTS SAUDI ARABIA), AEP(EXCEPT FEDERAL REPUBLIC OF GERMANY,NORWAY, DENMARK,FINLAND),AUS)...MOUNTED PCB, MAIN           |         |     |      |
| 912     | A-3660-557-A  | (E(MIDDLE EASTS, SAUDI ARABIA), AEP(NORWAY,FINLAND,DENMARK),UK)...MOUNTED PCB MAIN   |         |     |      |
| 913     | *A-3660-559-A | (US,Canadian)...MOUNTED PCB, MAIN  |         |     |      |
| 914     | *A-3684-073-A | MOUNTED PCB, JACK  |         |     |      |
| 915     | *A-3689-056-A | PC BOARD ASSY, KEY   |         |     |      |
| BPF1    | 1-235-402-11  | (US,Canadian,E(EXCEPT MIDDLE EASTS,SAUDI ARABIA),AEP(EXCEPT DENMARK,FINLAND,NORWAY,FEDERAL REPUBLIC OF GERMANY),AUS)...FILTER, BAND PASS |         |     |      |
| C2      | 1-163-179-00  | CERAMIC  | 82PF    | 10% | 50V  |
| C3      | 1-163-177-00  | CERAMIC  | 68PF    | 5%  | 50V  |
| C5      | 1-162-331-00  | CERAMIC  | 6.8PF   | 10% | 50V  |
| C4      | 1-162-331-00  | CERAMIC  | 6.8PF   | 10% | 50V  |
| C6      | 1-163-205-00  | CERAMIC  | 0.001MF | 10% | 50V  |
| C7      | 1-162-325-00  | CERAMIC  | 2.2PF   | 10% | 50V  |
| C8      | 1-163-059-00  | CERAMIC  | 0.01MF  | 20% | 16V  |
| C9      | 1-163-205-00  | CERAMIC  | 0.001MF | 10% | 50V  |
| C10     | 1-163-205-00  | CERAMIC  | 0.001MF | 10% | 50V  |
| C11     | 1-163-059-00  | CERAMIC  | 0.01MF  | 20% | 16V  |
| C12     | 1-163-159-00  | CERAMIC  | 12PF    | 5%  | 50V  |
| C13     | 1-162-330-00  | CERAMIC  | 5.6PF   | 10% | 50V  |
| C14     | 1-123-612-00  | ELECT  | 2.2MF   | 20% | 50V  |
| C15     | 1-163-059-00  | CERAMIC  | 0.01MF  | 20% | 16V  |
| C16     | 1-163-059-00  | CERAMIC  | 0.01MF  | 20% | 16V  |
| C17     | 1-163-059-00  | CERAMIC  | 0.01MF  | 20% | 16V  |
| C18     | 1-163-172-00  | CERAMIC  | 43PF    | 5%  | 50V  |
| C19     | 1-123-618-00  | ELECT  | 22MF    | 20% | 6.3V |
| C20     | 1-163-059-00  | CERAMIC  | 0.01MF  | 20% | 16V  |
| C21     | 1-163-059-00  | CERAMIC  | 0.01MF  | 20% | 16V  |
| C22     | 1-163-059-00  | CERAMIC  | 0.01MF  | 20% | 16V  |
| C23     | 1-162-180-00  | CERAMIC  | 0.47MF  |     | 50V  |
| C24     | 1-131-383-00  | TANTALUM   | 10MF    | 20% | 6.3V |
| C25     | 1-163-059-00  | CERAMIC  | 0.01MF  | 20% | 16V  |
| C26     | 1-163-059-00  | CERAMIC  | 0.01MF  | 20% | 16V  |

ELECTRICAL PARTS

| Ref.No. | Part No.     | Description |          |     |      |
|---------|--------------|-------------|----------|-----|------|
| C27     | 1-163-059-00 | CERAMIC     | 0.01MF   | 20% | 16V  |
| C28     | 1-163-059-00 | CERAMIC     | 0.01MF   | 20% | 16V  |
| C29     | 1-163-059-00 | CERAMIC     | 0.01MF   | 20% | 16V  |
| C30     | 1-163-059-00 | CERAMIC     | 0.01MF   | 20% | 16V  |
| C31     | 1-123-617-00 | ELECT       | 10MF     | 20% | 16V  |
| C33     | 1-163-059-00 | CERAMIC     | 0.01MF   | 20% | 16V  |
| C34     | 1-163-059-00 | CERAMIC     | 0.01MF   | 20% | 16V  |
| C35     | 1-163-181-00 | CERAMIC     | 100PF    | 10% | 50V  |
| C36     | 1-123-647-00 | ELECT       | 47MF     | 20% | 6.3V |
| C38     | 1-163-059-00 | CERAMIC     | 0.01MF   | 20% | 16V  |
| C39     | 1-163-165-00 | CERAMIC     | 22PF     | 5%  | 50V  |
| C40     | 1-123-617-00 | ELECT       | 10MF     | 20% | 16V  |
| C41     | 1-163-161-00 | CERAMIC     | 15PF     | 5%  | 50V  |
| C42     | 1-163-059-00 | CERAMIC     | 0.01MF   | 20% | 16V  |
| C44     | 1-163-059-00 | CERAMIC     | 0.01MF   | 20% | 16V  |
| C45     | 1-123-611-00 | ELECT       | 1MF      | 20% | 50V  |
| C46     | 1-163-205-00 | CERAMIC     | 0.001MF  | 10% | 50V  |
| C47     | 1-131-402-00 | TANTALUM    | 0.1MF    | 20% | 35V  |
| C48     | 1-123-611-00 | ELECT       | 1MF      | 20% | 50V  |
| C49     | 1-163-059-00 | CERAMIC     | 0.01MF   | 20% | 16V  |
| C50     | 1-163-165-00 | CERAMIC     | 22PF     | 5%  | 50V  |
| C51     | 1-163-151-00 | CERAMIC     | 3.9PF    | 10% | 50V  |
| C52     | 1-163-205-00 | CERAMIC     | 0.001MF  | 10% | 50V  |
| C53     | 1-163-205-00 | CERAMIC     | 0.001MF  | 10% | 50V  |
| C54     | 1-163-161-00 | CERAMIC     | 15PF     | 5%  | 50V  |
| C55     | 1-163-059-00 | CERAMIC     | 0.01MF   | 20% | 16V  |
| C56     | 1-163-205-00 | CERAMIC     | 0.001MF  | 10% | 50V  |
| C57     | 1-163-059-00 | CERAMIC     | 0.01MF   | 20% | 16V  |
| C58     | 1-163-205-00 | CERAMIC     | 0.001MF  | 10% | 50V  |
| C59     | 1-163-059-00 | CERAMIC     | 0.01MF   | 20% | 16V  |
| C60     | 1-163-055-00 | CERAMIC     | 0.0047MF | 30% | 16V  |
| C61     | 1-163-147-00 | CERAMIC     | 1PF      | 20% | 50V  |
| C62     | 1-163-205-00 | CERAMIC     | 0.001MF  | 10% | 50V  |
| C63     | 1-163-059-00 | CERAMIC     | 0.01MF   | 20% | 16V  |
| C64     | 1-162-325-00 | CERAMIC     | 2.2PF    | 10% | 50V  |
| C65     | 1-163-147-00 | CERAMIC     | 1PF      | 20% | 50V  |
| C66     | 1-163-059-00 | CERAMIC     | 0.01MF   | 20% | 16V  |
| C67     | 1-102-973-00 | CERAMIC     | 100PF    | 5%  | 50V  |
| C68     | 1-124-442-00 | ELECT       | 330MF    | 20% | 6.3V |
| C70     | 1-163-059-00 | CERAMIC     | 0.01MF   | 20% | 16V  |
| C71     | 1-163-059-00 | CERAMIC     | 0.01MF   | 20% | 16V  |
| C72     | 1-123-616-00 | ELECT       | 4.7MF    | 20% | 25V  |
| C73     | 1-163-059-00 | CERAMIC     | 0.01MF   | 20% | 16V  |
| C74     | 1-163-059-00 | CERAMIC     | 0.01MF   | 20% | 16V  |
| C75     | 1-131-412-00 | TANTALUM    | 0.47MF   | 20% | 20V  |

## ELECTRICAL PARTS

| Ref.No. | Part No.     | Description |          |     |      |  |
|---------|--------------|-------------|----------|-----|------|--|
| C76     | 1-123-610-00 | ELECT       | 0.47MF   | 20% | 50V  |  |
| C77     | 1-123-610-00 | ELECT       | 0.47MF   | 20% | 50V  |  |
| C78     | 1-123-610-00 | ELECT       | 0.47MF   | 20% | 50V  |  |
| C79     | 1-131-402-00 | TANTALUM    | 0.1MF    | 20% | 35V  |  |
| C80     | 1-163-059-00 | CERAMIC     | 0.01MF   | 20% | 16V  |  |
| C81     | 1-163-059-00 | CERAMIC     | 0.01MF   | 20% | 16V  |  |
| C82     | 1-123-616-00 | ELECT       | 4.7MF    | 20% | 25V  |  |
| C83     | 1-163-209-00 | CERAMIC     | 0.0015MF | 30% | 16V  |  |
| C84     | 1-123-616-00 | ELECT       | 4.7MF    | 20% | 25V  |  |
| C85     | 1-163-059-00 | CERAMIC     | 0.01MF   | 20% | 16V  |  |
| C86     | 1-163-059-00 | CERAMIC     | 0.01MF   | 20% | 16V  |  |
| C87     | 1-123-611-00 | ELECT       | 1MF      | 20% | 50V  |  |
| C88     | 1-123-610-00 | ELECT       | 0.47MF   | 20% | 50V  |  |
| C89     | 1-123-617-00 | ELECT       | 10MF     | 20% | 16V  |  |
| C90     | 1-123-607-00 | ELECT       | 0.1MF    | 20% | 50V  |  |
| C91     | 1-163-059-00 | CERAMIC     | 0.01MF   | 20% | 16V  |  |
| C92     | 1-163-059-00 | CERAMIC     | 0.01MF   | 20% | 16V  |  |
| C93     | 1-131-401-00 | TANTALUM    | 0.068MF  | 20% | 35V  |  |
| C94     | 1-163-205-00 | CERAMIC     | 0.001MF  | 10% | 50V  |  |
| C95     | 1-123-611-00 | ELECT       | 1MF      | 20% | 50V  |  |
| C96     | 1-163-169-00 | CERAMIC     | 33PF     | 5%  | 50V  |  |
| C97     | 1-163-173-00 | CERAMIC     | 47PF     | 5%  | 50V  |  |
| C98     | 1-162-180-00 | CERAMIC     | 0.47MF   |     | 50V  |  |
| C99     | 1-123-661-00 | ELECT       | 100MF    | 20% | 6.3V |  |
| C100    | 1-123-647-00 | ELECT       | 47MF     | 20% | 6.3V |  |
| C101    | 1-163-059-00 | CERAMIC     | 0.01MF   | 20% | 16V  |  |
| C102    | 1-123-646-00 | ELECT       | 33MF     | 20% | 6.3V |  |
| C103    | 1-123-616-00 | ELECT       | 4.7MF    | 20% | 25V  |  |
| C104    | 1-163-163-00 | CERAMIC     | 18PF     | 5%  | 50V  |  |
| C105    | 1-163-059-00 | CERAMIC     | 0.01MF   | 20% | 16V  |  |
| C106    | 1-123-617-00 | ELECT       | 10MF     | 20% | 16V  |  |
| C107    | 1-163-059-00 | CERAMIC     | 0.01MF   | 20% | 16V  |  |
| C108    | 1-163-161-00 | CERAMIC     | 15PF     | 5%  | 50V  |  |
| C109    | 1-163-169-00 | CERAMIC     | 33PF     | 5%  | 50V  |  |
| C110    | 1-163-157-00 | CERAMIC     | 10PF     | 5%  | 50V  |  |
| C111    | 1-163-059-00 | CERAMIC     | 0.01MF   | 20% | 16V  |  |
| *1C112  | 1-130-834-00 | FILM        | 1MF      | 10% | 63V  |  |
| C113    | 1-163-059-00 | CERAMIC     | 0.01MF   | 20% | 16V  |  |
| C114    | 1-163-159-00 | CERAMIC     | 12PF     | 5%  | 50V  |  |
| C115    | 1-163-147-00 | CERAMIC     | 1PF      | 20% | 50V  |  |
| C116    | 1-123-661-00 | ELECT       | 100MF    | 20% | 6.3V |  |
| C117    | 1-163-059-00 | CERAMIC     | 0.01MF   | 20% | 16V  |  |
| C118    | 1-163-059-00 | CERAMIC     | 0.01MF   | 20% | 16V  |  |
| C119    | 1-163-147-00 | CERAMIC     | 1PF      | 20% | 50V  |  |
| C120    | 1-163-059-00 | CERAMIC     | 0.01MF   | 20% | 16V  |  |

## ELECTRICAL PARTS

| Ref.No. | Part No.     | Description |         |     |      |  |
|---------|--------------|-------------|---------|-----|------|--|
| C121    | 1-163-059-00 | CERAMIC     | 0.01MF  | 20% | 16V  |  |
| C122    | 1-123-617-00 | ELECT       | 10MF    | 20% | 16V  |  |
| C123    | 1-163-059-00 | CERAMIC     | 0.01MF  | 20% | 16V  |  |
| C124    | 1-163-059-00 | CERAMIC     | 0.01MF  | 30% | 16V  |  |
| C125    | 1-163-059-00 | CERAMIC     | 0.01MF  | 20% | 16V  |  |
| C126    | 1-163-205-00 | CERAMIC     | 0.001MF | 10% | 50V  |  |
| C127    | 1-163-059-00 | CERAMIC     | 0.01MF  | 20% | 16V  |  |
| C128    | 1-163-166-00 | CERAMIC     | 24PF    | 5%  | 50V  |  |
| C129    | 1-163-059-00 | CERAMIC     | 0.01MF  | 20% | 16V  |  |
| C130    | 1-163-205-00 | CERAMIC     | 0.001MF | 10% | 50V  |  |
| C131    | 1-162-331-00 | CERAMIC     | 6.8PF   | 10% | 50V  |  |
| C132    | 1-163-167-00 | CERAMIC     | 27PF    | 5%  | 50V  |  |
| C133    | 1-163-166-00 | CERAMIC     | 24PF    | 5%  | 50V  |  |
| C134    | 1-102-074-00 | CERAMIC     | 0.001MF | 10% | 50V  |  |
| C135    | 1-123-617-00 | ELECT       | 10MF    | 20% | 16V  |  |
| C136    | 1-163-059-00 | CERAMIC     | 0.01MF  | 20% | 16V  |  |
| C137    | 1-163-059-00 | CERAMIC     | 0.01MF  | 20% | 16V  |  |
| *1C138  | 1-130-833-00 | FILM        | 0.82MF  | 10% | 63V  |  |
| C139    | 1-124-442-00 | ELECT       | 330MF   | 20% | 6.3V |  |
| C140    | 1-162-325-00 | CERAMIC     | 2.2PF   | 10% | 50V  |  |
| C141    | 1-163-059-00 | CERAMIC     | 0.01MF  | 20% | 16V  |  |
| C142    | 1-163-059-00 | CERAMIC     | 0.01MF  | 20% | 16V  |  |
| C143    | 1-163-147-00 | CERAMIC     | 1PF     | 20% | 50V  |  |
| C144    | 1-163-147-00 | CERAMIC     | 1PF     | 20% | 50V  |  |
| C145    | 1-163-173-00 | CERAMIC     | 47PF    | 5%  | 50V  |  |
| C146    | 1-163-205-00 | CERAMIC     | 0.001MF | 10% | 50V  |  |
| C147    | 1-163-059-00 | CERAMIC     | 0.01MF  | 20% | 16V  |  |
| C148    | 1-163-173-00 | CERAMIC     | 47PF    | 5%  | 50V  |  |
| C149    | 1-163-205-00 | CERAMIC     | 0.001MF | 10% | 50V  |  |
| C150    | 1-163-059-00 | CERAMIC     | 0.01MF  | 20% | 16V  |  |
| C151    | 1-163-205-00 | CERAMIC     | 0.001MF | 10% | 50V  |  |
| C152    | 1-163-059-00 | CERAMIC     | 0.01MF  | 20% | 16V  |  |
| C153    | 1-163-175-00 | CERAMIC     | 56PF    | 5%  | 50V  |  |
| C154    | 1-163-173-00 | CERAMIC     | 47PF    | 5%  | 50V  |  |
| C155    | 1-163-177-00 | CERAMIC     | 68PF    | 5%  | 50V  |  |
| C156    | 1-123-661-00 | ELECT       | 100MF   | 20% | 6.3V |  |
| C157    | 1-102-108-00 | CERAMIC     | 150PF   | 20% | 50V  |  |
| C158    | 1-163-169-00 | CERAMIC     | 33PF    | 5%  | 50V  |  |
| C159    | 1-123-661-00 | ELECT       | 100MF   | 20% | 6.3V |  |
| C160    | 1-124-470-11 | ELECT       | 470MF   | 20% | 6.3V |  |
| C161    | 1-121-805-00 | ELECT       | 330MF   | 20% | 10V  |  |
| C162    | 1-124-442-00 | ELECT       | 330MF   | 20% | 6.3V |  |
| C163    | 1-162-180-00 | CERAMIC     | 0.47MF  |     | 50V  |  |
| C164    | 1-124-444-11 | ELECT       | 220MF   | 20% | 6.3V |  |
| C165    | 1-163-157-00 | CERAMIC     | 10PF    | 5%  | 50V  |  |

\*1 See page 86, since the capacities are different by the replacement IC of IC4 and IC6.

## ELECTRICAL PARTS

| Ref.No. | Part No.     | Description  |        |     |      |
|---------|--------------|--------------|--------|-----|------|
| C166    | 1-162-325-00 | CERAMIC      | 2.2PF  | 10% | 50V  |
| C167    | 1-161-013-00 | CERAMIC      | 0.01MF | 10% | 25V  |
| C168    | 1-161-013-00 | CERAMIC      | 0.01MF | 10% | 25V  |
| C169    | 1-162-430-11 | CERAMIC      | 180PF  | 10% | 50V  |
| C170    | 1-163-059-00 | CERAMIC      | 0.01MF | 20% | 16V  |
| C171    | 1-163-059-00 | CERAMIC      | 0.01MF | 20% | 16V  |
| C172    | 1-163-059-00 | CERAMIC      | 0.01MF | 20% | 16V  |
| C173    | 1-163-177-00 | CERAMIC      | 68PF   | 5%  | 50V  |
| C174    | 1-163-177-00 | CERAMIC      | 68PF   | 5%  | 50V  |
| C175    | 1-162-392-00 | CERAMIC      | 150PF  | 10% | 50V  |
| C176    | 1-162-392-00 | CERAMIC      | 150PF  | 10% | 50V  |
| C301    | 1-124-470-11 | ELECT        | 470MF  | 20% | 6.3V |
| C302    | 1-163-059-00 | CERAMIC      | 0.01MF | 20% | 16V  |
| C303    | 1-163-059-00 | CERAMIC      | 0.01MF | 20% | 16V  |
| C304    | 1-163-181-00 | CERAMIC      | 100PF  | 10% | 50V  |
| C305    | 1-123-611-00 | ELECT        | 1MF    | 20% | 50V  |
| C306    | 1-123-617-00 | ELECT        | 10MF   | 20% | 16V  |
| C307    | 1-163-175-00 | CERAMIC      | 56PF   | 5%  | 50V  |
| C308    | 1-163-176-00 | CERAMIC      | 62PF   | 5%  | 50V  |
| C309    | 1-163-189-00 | CERAMIC      | 220PF  | 10% | 50V  |
| C310    | 1-162-434-11 | CERAMIC      | 820PF  | 10% | 50V  |
| C311    | 1-123-617-00 | ELECT        | 10MF   | 20% | 16V  |
| C312    | 1-123-618-00 | ELECT        | 22MF   | 20% | 6.3V |
| C314    | 1-162-392-00 | CERAMIC      | 150PF  | 10% | 50V  |
| C401    | 1-123-617-00 | ELECT        | 10MF   | 20% | 16V  |
| C402    | 1-131-383-00 | TANTALUM     | 10MF   | 10% | 6.3V |
| C501    | 1-135-099-00 | TANTAL. CHIP | 2.2MF  | 20% | 6.3V |
| C502    | 1-135-099-00 | TANTAL. CHIP | 2.2MF  | 20% | 6.3V |
| C503    | 1-135-099-00 | TANTAL. CHIP | 2.2MF  | 20% | 6.3V |
| C504    | 1-135-100-21 | TANTAL. CHIP | 6.8MF  | 20% | 6.3V |
| C505    | 1-163-059-00 | CERAMIC      | 0.01MF | 20% | 16V  |
| C506    | 1-163-059-00 | CERAMIC      | 0.01MF | 20% | 16V  |
| C507    | 1-163-059-00 | CERAMIC      | 0.01MF | 20% | 16V  |
| C508    | 1-163-059-00 | CERAMIC      | 0.01MF | 20% | 16V  |
| C509    | 1-163-169-00 | CERAMIC      | 33PF   | 5%  | 50V  |
| C510    | 1-163-169-00 | CERAMIC      | 33PF   | 5%  | 50V  |
| C511    | 1-135-105-00 | TANTAL. CHIP | 33MF   | 20% | 4V   |
| C512    | 1-163-059-00 | CERAMIC      | 0.01MF | 20% | 16V  |
| C513    | 1-163-059-00 | CERAMIC      | 0.01MF | 20% | 16V  |
| C514    | 1-163-167-00 | CERAMIC      | 27PF   | 5%  | 50V  |
| C515    | 1-162-330-00 | CERAMIC      | 5.6PF  | 5%  | 50V  |
| C516    | 1-135-104-00 | TANTAL. CHIP | 10MF   | 20% | 4V   |
| C517    | 1-163-059-00 | CERAMIC      | 0.01MF | 20% | 16V  |
| C518    | 1-163-059-00 | CERAMIC      | 0.01MF | 20% | 16V  |
| C520    | 1-163-059-00 | CERAMIC      | 0.01MF | 20% | 16V  |
| C601    | 1-163-059-00 | CERAMIC      | 0.01MF | 20% | 16V  |
| C602    | 1-163-177-00 | CERAMIC      | 68PF   | 5%  | 50V  |
| C603    | 1-163-059-00 | CERAMIC      | 0.01MF | 20% | 16V  |

## ELECTRICAL PARTS

| Ref.No. | Part No.      | Description   |          |       |      |
|---------|---------------|---|----------|-------|------|
| C604    | 1-163-177-00  | CERAMIC   | 68PF     | 5%    | 50V  |
| C605    | 1-123-646-00  | ELECT   | 33MF     | 20%   | 6.3V |
| C606    | 1-163-059-00  | CERAMIC   | 0.01MF   | 20%   | 16V  |
| C607    | 1-163-059-00  | CERAMIC   | 0.01MF   | 20%   | 16V  |
| C608    | 1-131-418-00  | TANTALUM  | 1MF      | 20%   | 10V  |
| C609    | 1-163-213-00  | CERAMIC   | 0.0022MF | 20%   | 16V  |
| C610    | 1-163-213-00  | CERAMIC   | 0.0022MF | 20%   | 16V  |
| C611    | 1-131-423-00  | TANTALUM  | 6.8MF    | 20%   | 6.3V |
| C612    | 1-163-205-00  | CERAMIC   | 1000PF   | 10%   | 50V  |
| C613    | 1-131-400-00  | TANTALUM  | 0.047MF  | 20%   | 35V  |
| C614    | 1-131-418-00  | TANTALUM  | 1MF      | 20%   | 10V  |
| C615    | 1-123-646-00  | ELECT   | 33MF     | 20%   | 6.3V |
| C616    | 1-163-059-00  | CERAMIC   | 0.01MF   | 20%   | 16V  |
| C617    | 1-163-193-00  | CERAMIC   | 330PF    | 10%   | 50V  |
| C618    | 1-163-193-00  | CERAMIC   | 330PF    | 10%   | 50V  |
| C619    | 1-163-059-00  | CERAMIC   | 0.01MF   | 20%   | 16V  |
| C620    | 1-102-942-00  | (SELECTED TO MATCH X601)...<br>CERAMIC  | 5PF      | 0.5PF | 50V  |
| C620    | 1-102-951-00  | (SELECTED TO MATCH X601)...<br>CERAMIC  | 15PF     | 0.5PF | 50V  |
| C621    | 1-161-039-00  | CERAMIC   | 0.001MF  | 10%   | 25V  |
| C622    | 1-163-059-00  | CERAMIC   | 0.01MF   | 30%   | 16V  |
| C701    | 1-163-172-00  | CERAMIC   | 43PF     | 5%    | 50V  |
| C702    | 1-123-618-00  | ELECT   | 22MF     | 20%   | 6.3V |
| C703    | 1-123-622-00  | ELECT   | 22MF     | 20%   | 16V  |
| C704    | 1-162-179-11  | CERAMIC   | 0.1MF    |       | 50V  |
| CF1     | 1-527-795-71  | FILTER, CERAMIC   |          |       |      |
| CF2     | 1-527-795-71  | FILTER, CERAMIC   |          |       |      |
| CFW1    | 1-527-392-00  | FILTER, CERAMIC   |          |       |      |
| CFW2    | 1-527-569-00  | FILTER, CERAMIC   |          |       |      |
| CNJ1    | *1-562-659-11 | SOCKET, CONNECTOR 9P  |          |       |      |
| CNJ2    | 1-562-660-11  | SOCKET, CONNECTOR 13P   |          |       |      |
| CNP601  | *1-560-531-00 | PIN, CONNECTOR 5P   |          |       |      |
| CNP602  | *1-508-980-11 | PIN, CONNECTOR  |          |       |      |
| CNP701  | *1-560-666-00 | PIN, CONNECTOR 3P   |          |       |      |
| CT1     | 1-141-272-00  | (US,Canadian,E(EXCEPT MIDDLE EASTS,<br>SAUDI ARABIA),AEP(EXCEPT DENMARK,FINLAND,NORWAY,<br>FEDERAL REPUBLIC OF GERMANY))...CAP, TRIMMER |          |       |      |
| CT2     | 1-141-229-00  | CAP, TRIMMER  |          |       |      |
| CT3     | 1-141-229-00  | CAP, TRIMMER  |          |       |      |
| CT4     | 1-141-227-00  | TRIMMER, CERAMIC  |          |       |      |
| CT5     | 1-141-229-00  | CAP, TRIMMER  |          |       |      |
| CT6     | 1-141-272-00  | CAP, TRIMMER  |          |       |      |
| CT7     | 1-141-229-00  | CAP, TRIMMER  |          |       |      |
| CT501   | 1-141-296-21  | CAP, TRIMMER  |          |       |      |
| CT601   | 1-141-318-11  | CAP, TRIMMER  |          |       |      |

ELECTRICAL PARTS

| Ref.No. | Part No.     | Description  |
|---------|--------------|--|
| D1      | 8-719-104-15 | (EXCEPT E(MIDDLE EASTS, SAUDI ARABIA), UK, AEP(DENMARK, FINLAND, NORWAY, FEDERAL REPUBLIC OF GERMANY))...DIODE 1T26N |
| D2      | 8-719-911-19 | DIODE 1SS119   |
| D3      | 8-719-911-19 | DIODE 1SS119   |
| D4      | 8-719-903-27 | DIODE 1SS168   |
| D5      | 8-719-903-27 | DIODE 1SS168   |
| D6      | 8-719-911-19 | DIODE 1SS119   |
| D7      | 8-719-911-19 | DIODE 1SS119   |
| D9      | 8-719-911-06 | DIODE 1SS106   |
| D10     | 8-719-911-06 | DIODE 1SS106   |
| D11     | 8-719-911-06 | DIODE 1SS106   |
| D12     | 8-719-911-06 | DIODE 1SS106   |
| D14     | 8-719-915-36 | DIODE SLP145B  |
| D15     | 8-719-104-15 | DIODE 1T26N  |
| D16     | 8-713-300-00 | (EXCEPT E(MIDDLE EASTS, SAUDI ARABIA), UK, AEP(DENMARK, FINLAND, NORWAY, FEDERAL REPUBLIC OF GERMANY))...DIODE 1T33  |
| D17     | 8-719-104-15 | (EXCEPT E(MIDDLE EASTS, SAUDI ARABIA), UK, AEP(DENMARK, FINLAND, NORWAY, FEDERAL REPUBLIC OF GERMANY))...DIODE 1T26N |
| D18     | 8-713-300-00 | DIODE 1T33   |
| D19     | 8-713-300-00 | DIODE 1T33   |
| D20     | 8-719-911-19 | DIODE 1SS119   |
| D21     | 8-719-911-19 | DIODE 1SS119   |
| D22     | 8-719-911-19 | DIODE 1SS119   |
| D25     | 8-719-911-19 | DIODE 1SS119   |
| D26     | 8-719-911-19 | DIODE 1SS119   |
| D27     | 8-713-300-00 | DIODE 1T33   |
| D28     | 8-713-300-00 | DIODE 1T33   |
| D29     | 8-713-300-00 | DIODE 1T33   |
| D30     | 8-713-300-00 | DIODE 1T33   |
| D31     | 8-719-911-19 | DIODE 1SS119   |
| D32     | 8-719-911-19 | DIODE 1SS119   |
| D33     | 8-719-911-19 | DIODE 1SS119   |
| D34     | 8-719-911-19 | DIODE 1SS119   |
| D35     | 8-719-911-19 | DIODE 1SS119   |
| D36     | 8-719-911-19 | DIODE 1SS119   |
| D301    | 8-719-911-19 | DIODE 1SS119   |
| D302    | 8-719-911-19 | DIODE 1SS119   |
| D303    | 8-719-104-15 | DIODE 1T26N  |
| D304    | 8-719-000-12 | DIODE MC931  |
| D305    | 8-719-000-12 | DIODE MC931  |
| D401    | 8-719-800-54 | DIODE TLUR-122   |
| D402    | 8-719-800-54 | DIODE TLUR-122   |
| D403    | 8-719-800-54 | DIODE TLUR-122   |
| D404    | 8-719-800-54 | DIODE TLUR-122   |

ELECTRICAL PARTS

| Ref.No. | Part No.     | Description       |
|---------|--------------|-------------------|
| D405    | 8-719-800-54 | DIODE TLUR-122    |
| D406    | 8-719-800-54 | DIODE TLUR-122    |
| D407    | 8-719-800-54 | DIODE TLUR-122    |
| D408    | 8-719-800-54 | DIODE TLUR-122    |
| D409    | 8-719-800-54 | DIODE TLUR-122    |
| D410    | 8-719-800-54 | DIODE TLUR-122    |
| D411    | 8-719-800-54 | DIODE TLUR-122    |
| D412    | 8-719-800-54 | DIODE TLUR-122    |
| D501    | 8-719-915-35 | DIODE SLP236F-50U |
| D503    | 8-719-100-03 | DIODE 1S2835      |
| D504    | 8-719-100-03 | DIODE 1S2835      |
| D505    | 8-719-100-03 | DIODE 1S2835      |
| D506    | 8-719-100-03 | DIODE 1S2835      |
| D507    | 8-719-100-03 | DIODE 1S2835      |
| D508    | 8-719-100-03 | DIODE 1S2835      |
| D509    | 8-719-100-03 | DIODE 1S2835      |
| D510    | 8-719-100-03 | DIODE 1S2835      |
| D511    | 8-719-100-03 | DIODE 1S2835      |
| D512    | 8-719-100-03 | DIODE 1S2835      |
| D513    | 8-719-100-03 | DIODE 1S2835      |
| D514    | 8-719-100-03 | DIODE 1S2835      |
| D515    | 8-719-100-03 | DIODE 1S2835      |
| D516    | 8-719-101-23 | DIODE 1SS123      |
| D518    | 8-719-100-03 | DIODE 1S2835      |
| D519    | 8-719-100-03 | DIODE 1S2835      |
| D601    | 8-713-300-00 | DIODE 1T33        |
| D602    | 8-719-911-19 | DIODE 1SS119      |
| D701    | 8-719-910-26 | DIODE HZ1283L     |
| D702    | 8-719-911-19 | DIODE 1SS119      |
| IC1     | 8-759-801-14 | IC LA1205         |
| IC2     | 8-759-103-93 | IC UPC393C        |
| IC3     | 8-759-103-93 | IC UPC393C        |
| *2IC4   | 8-759-961-10 | IC CX-7961A       |
| IC5     | 8-759-110-37 | IC UPC1037H       |
| *2IC6   | 8-759-961-10 | IC CX-7961A       |
| IC7     | 8-759-110-37 | IC UPC1037H       |
| IC9     | 8-759-800-27 | IC LA5003         |
| IC10    | 8-759-340-66 | IC HD14066BP      |
| IC11    | 8-759-340-69 | IC HD14069UBP     |
| IC12    | 8-759-340-01 | IC HD14001BP      |
| IC13    | 8-759-340-01 | IC HD14001BP      |
| IC14    | 8-759-340-11 | IC HD14011BP      |
| IC15    | 8-759-340-11 | IC HD14011BP      |
| IC16    | 8-759-340-11 | IC HD14011BP      |
| IC17    | 8-759-800-97 | IC LA4146         |
| IC401   | 8-759-800-82 | IC LB1411         |
| IC501   | 8-759-102-02 | IC UPD7503G-124   |

\*2 Be sure to see Note on service on page 86 (back cover), when replacing IC4 and/or IC6.

## ELECTRICAL PARTS

| Ref.No. | Part No.     | Description  |
|---------|--------------|--|
| IC502   | 8-759-102-03 | IC UPD7503G-187  |
| IC503   | 8-759-145-32 | IC UPD4532BC   |
| IC504   | 8-759-240-13 | IC TC4013BP  |
| IC505   | 8-759-300-99 | IC HD14071BFP  |
| IC506   | 8-759-300-73 | IC HD14081BFP  |
| IC507   | 8-759-300-69 | IC HD14001BFP  |
| IC601   | 8-759-907-69 | IC CX-857  |
| IFT A1  | 1-404-602-11 | TRANSFORMER, IFT   |
| IFT A2  | 1-404-191-00 | TRANSFORMER, IF  |
| IFT A3  | 1-404-362-00 | TRANSFORMER, IF  |
| IFT A4  | 1-404-127-00 | IFT (SMALL TYPE)   |
| IFT F1  | 1-404-126-00 | IFT (SMALL TYPE)   |
| J301    | 1-507-973-11 | JACK (AM EXT ANT)  |
| J302    | 1-507-974-11 | JACK (AIR/FM EXT ANT OR FM EXT ANT)  |
| J303    | 1-507-853-13 | JACK (EARPHONE)  |
| J304    | 1-507-527-00 | JACK (EARPHONE)  |
| J305    | 1-507-954-11 | JACK, EXTERNAL POWER   |
| L1      | 1-408-902-21 | MICRO INDUCTOR 0.47UH  |
| L2      | 1-408-551-00 | MICRO INDUCTOR 1UH   |
| L3      | 1-408-553-00 | MICRO INDUCTOR 1.5UH   |
| L4      | 1-410-001-11 | MICRO INDUCTOR 0.22UH  |
| L5      | 1-426-158-00 | COIL (RF)  |
| L6      | 1-426-158-00 | COIL (RF)  |
| L7      | 1-425-613-00 | COIL, AIR-CORE, QF TYPE  |
| L8      | 1-408-569-00 | MICRO INDUCTOR 33UH  |
| L9      | 1-404-624-11 | TRANSFORMER, IF  |
| L10     | 1-459-573-11 | (US,Canadian,E(EXCEPT MIDDLE EASTS, SAUDI ARABIA),AEP(EXCEPT DENMARK,FINLAND,NORWAY,FEDERAL REPUBLIC OF GERMANY),AUS)...COIL (WITH CORE)     |
| L11     | 1-459-571-11 | COIL (WITH CORE)   |
| L12     | 1-407-882-00 | COIL   |
| L13     | 1-422-201-11 | COIL   |
| L14     | 1-422-200-11 | COIL   |
| L15     | 1-410-191-51 | INDUCTOR CHIP 0.82UH   |
| L16     | 1-410-188-51 | INDUCTOR CHIP 0.47UH   |
| L17     | 1-408-575-00 | MICRO INDUCTOR 100UH   |
| L18     | 1-422-199-11 | COIL   |
| L19     | 1-408-554-00 | MICRO INDUCTOR 1.8UH   |
| L20     | 1-410-202-11 | INDUCTOR CHIP 6.8UH  |
| L21     | 1-408-551-00 | MICRO INDUCTOR 1UH   |
| L22     | 1-408-903-11 | MICRO INDUCTOR 0.39UH  |
| L23     | 1-425-613-00 | COIL, AIR-CORE, QF TYPE  |
| L25     | 1-410-181-51 | (US,Canadian,E(EXCEPT MIDDLE EASTS, SAUDI ARABIA),AEP(EXCEPT DENMARK,FINLAND,NORWAY,FEDERAL REPUBLIC OF GERMANY),AUS)...INDUCTOR CHIP 0.12UH |

## ELECTRICAL PARTS

| Ref.No. | Part No.     | Description  |
|---------|--------------|--|
| L26     | 1-410-181-51 | (US,Canadian,E(EXCEPT MIDDLE EASTS, SAUDI ARABIA),AEP(EXCEPT DENMARK,FINLAND,NORWAY,FEDERAL REPUBLIC OF GERMANY),AUS)...INDUCTOR CHIP 0.12UH |
| L27     | 1-410-191-51 | (US,Canadian,E(EXCEPT MIDDLE EASTS, SAUDI ARABIA),AEP(EXCEPT DENMARK,FINLAND,NORWAY,FEDERAL REPUBLIC OF GERMANY),AUS)...INDUCTOR CHIP 0.82UH |
| L29     | 1-410-191-51 | (US,Canadian,E(EXCEPT MIDDLE EASTS, SAUDI ARABIA),AEP(EXCEPT DENMARK,FINLAND,NORWAY,FEDERAL REPUBLIC OF GERMANY),AUS)...INDUCTOR CHIP 0.82UH |
| L301    | 1-402-139-11 | ANTENNA, FERRITE-ROD (LW)  |
| L302    | 1-408-575-00 | MICRO INDUCTOR 100UH   |
| L303    | 1-408-578-00 | MICRO INDUCTOR 180UH   |
| L304    | 1-408-900-11 | MICRO INDUCTOR 0.82UH  |
| L305    | 1-408-565-00 | MICRO INDUCTOR 15UH  |
| L306    | 1-408-579-31 | MICRO INDUCTOR 220UH   |
| L307    | 1-408-567-00 | MICRO INDUCTOR 22UH  |
| L308    | 1-408-801-11 | MICRO INDUCTOR 0.22UH  |
| L601    | 1-408-575-00 | MICRO INDUCTOR 100UH   |
| L701    | 1-408-575-00 | MICRO INDUCTOR 100UH   |
| L702    | 1-408-575-00 | MICRO INDUCTOR 100UH   |
| MCF1    | 1-527-372-00 | FILTER, CRYSTAL  |
| MCF2    | 1-527-372-00 | FILTER, CRYSTAL  |
| PSN     | 1-464-407-11 | CIRCUIT UNIT, 2CH AMPLIFIER  |
| Q1      | 8-729-800-42 | TRANSISTOR 2SK152  |
| Q2      | 8-729-800-42 | TRANSISTOR 2SK152  |
| Q3      | 8-729-119-32 | TRANSISTOR 2SK193  |
| Q4      | 8-729-178-54 | TRANSISTOR 2SC2785   |
| Q5      | 8-729-115-30 | TRANSISTOR 2SK105A-30  |
| Q6      | 8-729-178-54 | TRANSISTOR 2SC2785   |
| Q8      | 8-729-900-90 | TRANSISTOR DTC144ES  |
| Q9      | 8-729-178-54 | TRANSISTOR 2SC2785   |
| Q10     | 8-729-178-54 | TRANSISTOR 2SC2785   |
| Q11     | 8-729-301-27 | (US,Canadian,E(EXCEPT MIDDLE EASTS, SAUDI ARABIA),AEP(EXCEPT DENMARK,FINLAND,NORWAY,FEDERAL REPUBLIC OF GERMANY),AUS)...TRANSISTOR 2SK439D   |
| Q12     | 8-729-119-32 | TRANSISTOR 2SK193  |
| Q13     | 8-729-178-62 | TRANSISTOR 2SC2786-L   |
| Q14     | 8-729-883-91 | TRANSISTOR 2SC2839-D   |
| Q15     | 8-729-178-54 | TRANSISTOR 2SC2785   |
| Q16     | 8-729-178-54 | TRANSISTOR 2SC2785   |
| Q17     | 8-729-612-77 | TRANSISTOR 2SA1027R  |
| Q18     | 8-729-178-54 | TRANSISTOR 2SC2785   |
| Q19     | 8-729-178-54 | TRANSISTOR 2SC2785   |
| Q20     | 8-729-178-54 | TRANSISTOR 2SC2785   |
| Q21     | 8-729-811-22 | TRANSISTOR 2SD1012-2   |
| Q22     | 8-729-218-42 | TRANSISTOR 2SK184  |
| Q23     | 8-729-178-54 | TRANSISTOR 2SC2785   |



ELECTRICAL PARTS

| Ref.No. | Part No.     | Description              |
|---------|--------------|--------------------------|
| Q24     | 8-729-218-42 | TRANSISTOR 2SK184        |
| Q25     | 8-729-178-54 | TRANSISTOR 2SC2785       |
| Q26     | 8-729-200-66 | TRANSISTOR 2SK192A       |
| Q27     | 8-729-800-83 | TRANSISTOR 2SB808        |
| Q28     | 8-729-200-66 | TRANSISTOR 2SK192A       |
| Q29     | 8-729-178-62 | TRANSISTOR 2SC2786-L     |
| Q30     | 8-729-178-62 | TRANSISTOR 2SC2786-L     |
| Q31     | 8-729-218-42 | TRANSISTOR 2SK184        |
| Q32     | 8-729-178-54 | TRANSISTOR 2SC2785       |
| Q33     | 8-729-200-33 | TRANSISTOR 2SK192A       |
| Q34     | 8-729-178-62 | TRANSISTOR 2SC2786-L     |
| Q35     | 8-729-800-00 | TRANSISTOR 2SB808        |
| Q36     | 8-729-900-90 | TRANSISTOR DTC144ES      |
| Q37     | 8-729-800-83 | TRANSISTOR 2SB808        |
| Q38     | 8-729-900-90 | TRANSISTOR DTC144ES      |
| Q39     | 8-729-800-83 | TRANSISTOR 2SB808        |
| Q40     | 8-729-801-83 | TRANSISTOR 2SB1013       |
| Q41     | 8-729-801-83 | TRANSISTOR 2SB1013       |
| Q42     | 8-729-178-54 | TRANSISTOR 2SC2785       |
| Q43     | 8-729-178-54 | TRANSISTOR 2SC2785       |
| Q44     | 8-729-900-90 | TRANSISTOR DTC144ES      |
| Q45     | 8-729-178-54 | TRANSISTOR 2SC2785       |
| Q46     | 8-729-181-13 | TRANSISTOR 2SB811        |
| Q47     | 8-729-178-54 | TRANSISTOR 2SC2785       |
| Q48     | 8-729-178-54 | TRANSISTOR 2SC2785       |
| Q301    | 8-729-178-54 | TRANSISTOR 2SC2785       |
| Q302    | 8-729-800-42 | TRANSISTOR 2SK152        |
| Q303    | 8-729-800-42 | TRANSISTOR 2SK152        |
| Q304    | 8-729-800-83 | TRANSISTOR 2SB808        |
| Q305    | 8-729-178-54 | TRANSISTOR 2SC2785       |
| Q306    | 8-729-178-54 | TRANSISTOR 2SC2785       |
| Q401    | 8-729-900-67 | TRANSISTOR DTA124XS      |
| Q501    | 8-729-100-66 | TRANSISTOR 2SC1623       |
| Q502    | 8-729-216-22 | TRANSISTOR 2SA1162       |
| Q504    | 8-729-100-66 | TRANSISTOR 2SC1623       |
| Q601    | 8-729-900-89 | TRANSISTOR DTC144ES      |
| Q602    | 8-729-900-89 | TRANSISTOR DTC144ES      |
| Q603    | 8-729-883-92 | TRANSISTOR 2SC2839       |
| Q701    | 8-729-178-54 | TRANSISTOR 2SC2785       |
| Q702    | 8-729-811-22 | TRANSISTOR 2SD1012-F2    |
| R1      | 1-247-819-00 | CARBON MELF 330 5% 1/5W  |
| R2      | 1-247-843-00 | CARBON MELF 3.3K 5% 1/5W |
| R3      | 1-247-855-00 | CARBON MELF 10K 5% 1/5W  |
| R4      | 1-247-839-00 | CARBON MELF 2.2K 5% 1/5W |
| R5      | 1-247-839-00 | CARBON MELF 2.2K 5% 1/5W |
| R6      | 1-247-867-00 | CARBON MELF 33K 5% 1/5W  |

ELECTRICAL PARTS

| Ref.No. | Part No.     | Description              |
|---------|--------------|--------------------------|
| R7      | 1-247-833-00 | CARBON MELF 1.2K 5% 1/5W |
| R8      | 1-247-839-00 | CARBON MELF 2.2K 5% 1/5W |
| R9      | 1-247-807-00 | CARBON MELF 100 5% 1/5W  |
| R10     | 1-247-807-00 | CARBON MELF 100 5% 1/5W  |
| R11     | 1-247-839-00 | CARBON MELF 2.2K 5% 1/5W |
| R12     | 1-247-791-00 | CARBON MELF 22 5% 1/5W   |
| R13     | 1-247-887-00 | CARBON MELF 220K 5% 1/5W |
| R14     | 1-247-875-00 | CARBON MELF 68K 5% 1/5W  |
| R15     | 1-247-873-00 | CARBON MELF 56K 5% 1/5W  |
| R16     | 1-247-831-00 | CARBON MELF 1K 5% 1/5W   |
| R17     | 1-247-849-00 | CARBON MELF 5.6K 5% 1/5W |
| R18     | 1-247-819-00 | CARBON MELF 330 5% 1/5W  |
| R19     | 1-247-851-00 | CARBON MELF 6.8K 5% 1/5W |
| R20     | 1-247-851-00 | CARBON MELF 6.8K 5% 1/5W |
| R21     | 1-247-849-00 | CARBON MELF 5.6K 5% 1/5W |
| R22     | 1-247-841-00 | CARBON MELF 2.7K 5% 1/5W |
| R23     | 1-247-851-00 | CARBON MELF 6.8K 5% 1/5W |
| R24     | 1-247-879-00 | CARBON MELF 100K 5% 1/5W |
| R25     | 1-247-849-00 | CARBON MELF 5.6K 5% 1/5W |
| R26     | 1-247-841-00 | CARBON MELF 2.7K 5% 1/5W |
| R27     | 1-247-851-00 | CARBON MELF 6.8K 5% 1/5W |
| R28     | 1-247-841-00 | CARBON 2.7K 5% 1/6W      |
| R29     | 1-247-855-00 | CARBON MELF 10K 5% 1/5W  |
| R30     | 1-247-863-00 | CARBON MELF 22K 5% 1/5W  |
| R31     | 1-247-791-00 | CARBON MELF 22 5% 1/5W   |
| R32     | 1-247-801-00 | CARBON 56 5% 1/6W        |
| R33     | 1-247-783-00 | CARBON MELF 10 5% 1/5W   |
| R34     | 1-247-807-00 | CARBON 100 5% 1/6W       |
| R35     | 1-247-839-00 | CARBON 2.2K 5% 1/5W      |
| R36     | 1-247-831-00 | CARBON MELF 1K 5% 1/5W   |
| R37     | 1-247-831-00 | CARBON MELF 1K 5% 1/5W   |
| R39     | 1-247-855-00 | CARBON MELF 10K 5% 1/5W  |
| R40     | 1-247-855-00 | CARBON MELF 10K 5% 1/5W  |
| R41     | 1-247-843-00 | CARBON MELF 3.3K 5% 1/5W |
| R42     | 1-247-825-00 | CARBON MELF 560 5% 1/5W  |
| R43     | 1-247-849-00 | CARBON 5.6K 5% 1/6W      |
| R44     | 1-247-831-00 | CARBON 1K 5% 1/6W        |
| R45     | 1-247-879-00 | CARBON MELF 100K 5% 1/5W |
| R46     | 1-247-879-00 | CARBON MELF 100K 5% 1/5W |
| R47     | 1-247-831-00 | CARBON MELF 1K 5% 1/5W   |
| R48     | 1-247-843-00 | CARBON MELF 3.3K 5% 1/5W |
| R49     | 1-247-831-00 | CARBON 1K 5% 1/6W        |
| R50     | 1-247-827-00 | CARBON 680 5% 1/6W       |
| R53     | 1-247-879-00 | CARBON MELF 100K 5% 1/5W |
| R54     | 1-247-879-00 | CARBON MELF 100K 5% 1/5W |

ELECTRICAL PARTS

| Ref.No. | Part No.     | Description  |      |    |      |
|---------|--------------|--|------|----|------|
| R55     | 1-247-879-00 | CARBON MELF  | 100K | 5% | 1/5W |
| R56     | 1-247-855-00 | CARBON MELF  | 10K  | 5% | 1/5W |
| R57     | 1-247-879-00 | CARBON MELF  | 100K | 5% | 1/5W |
| R58     | 1-247-879-00 | CARBON MELF  | 100K | 5% | 1/5W |
| R59     | 1-247-881-00 | CARBON MELF  | 120K | 5% | 1/5W |
| R60     | 1-247-869-00 | CARBON MELF  | 39K  | 5% | 1/5W |
| R61     | 1-247-855-00 | CARBON MELF  | 10K  | 5% | 1/5W |
| R62     | 1-247-863-00 | CARBON MELF  | 22K  | 5% | 1/5W |
| R63     | 1-247-879-00 | CARBON MELF  | 100K | 5% | 1/5W |
| R64     | 1-247-839-00 | CARBON MELF  | 2.2K | 5% | 1/5W |
| R65     | 1-247-839-00 | CARBON MELF  | 2.2K | 5% | 1/5W |
| R66     | 1-247-879-00 | CARBON MELF  | 100K | 5% | 1/5W |
| R67     | 1-247-837-00 | CARBON MELF  | 1.8K | 5% | 1/5W |
| R68     | 1-247-801-00 | CARBON MELF  | 56   | 5% | 1/5W |
| R69     | 1-247-795-00 | CARBON MELF  | 33   | 5% | 1/5W |
| R70     | 1-247-855-00 | CARBON MELF  | 10K  | 5% | 1/5W |
| R71     | 1-247-837-00 | CARBON MELF  | 1.8K | 5% | 1/5W |
| R72     | 1-247-855-00 | CARBON MELF  | 10K  | 5% | 1/5W |
| R73     | 1-247-855-00 | CARBON MELF  | 10K  | 5% | 1/5W |
| R74     | 1-247-791-00 | CARBON MELF  | 22   | 5% | 1/5W |
| R75     | 1-247-831-00 | CARBON MELF  | 1K   | 5% | 1/5W |
| R76     | 1-247-881-00 | CARBON MELF  | 120K | 5% | 1/5W |
| R77     | 1-247-839-00 | CARBON MELF  | 2.2K | 5% | 1/5W |
| R78     | 1-247-819-00 | CARBON MELF  | 330  | 5% | 1/5W |
| R79     | 1-247-783-00 | CARBON MELF  | 10   | 5% | 1/5W |
| R81     | 1-247-819-00 | CARBON MELF  | 330  | 5% | 1/5W |
| R82     | 1-247-883-00 | CARBON MELF  | 150K | 5% | 1/5W |
| R83     | 1-247-819-00 | CARBON MELF  | 330  | 5% | 1/5W |
| R84     | 1-247-801-00 | CARBON MELF  | 56   | 5% | 1/5W |
| R90     | 1-247-831-00 | CARBON MELF  | 1K   | 5% | 1/5W |
| R91     | 1-247-815-00 | (US,Canadian,E(SAUDI ARABIA,MIDDLE EASTS),UK,AEP(DENMARK,FINLAND,NORWAY) ...CARBON | 220  | 5% | 1/5W |
| R92     | 1-247-783-00 | CARBON MELF  | 10   | 5% | 1/5W |
| R93     | 1-247-855-00 | CARBON MELF  | 10K  | 5% | 1/5W |
| R94     | 1-247-855-00 | CARBON MELF  | 10K  | 5% | 1/5W |
| R95     | 1-247-843-00 | CARBON MELF  | 3.3K | 5% | 1/5W |
| R96     | 1-247-849-00 | CARBON MELF  | 5.6K | 5% | 1/5W |
| R97     | 1-247-787-00 | CARBON MELF  | 15   | 5% | 1/5W |
| R98     | 1-247-903-00 | CARBON MELF  | 1M   | 5% | 1/5W |
| R99     | 1-247-903-00 | CARBON MELF  | 1M   | 5% | 1/5W |
| R100    | 1-247-855-00 | CARBON MELF  | 10K  | 5% | 1/5W |
| R101    | 1-247-835-00 | CARBON MELF  | 1.5K | 5% | 1/5W |
| *3R102  | 1-247-839-00 | CARBON MELF  | 2.2K | 5% | 1/5W |
| R103    | 1-247-843-00 | CARBON MELF  | 3.3K | 5% | 1/5W |

ELECTRICAL PARTS

| Ref.No. | Part No.     | Description |      |    |      |
|---------|--------------|-------------|------|----|------|
| R104    | 1-247-831-00 | CARBON MELF | 1K   | 5% | 1/5W |
| R105    | 1-247-879-00 | CARBON MELF | 100K | 5% | 1/5W |
| R106    | 1-247-847-00 | CARBON MELF | 4.7K | 5% | 1/5W |
| R107    | 1-247-855-00 | CARBON MELF | 10K  | 5% | 1/5W |
| R108    | 1-247-847-00 | CARBON MELF | 4.7K | 5% | 1/5W |
| R109    | 1-247-791-00 | CARBON MELF | 22   | 5% | 1/5W |
| R110    | 1-247-783-00 | CARBON MELF | 10   | 5% | 1/5W |
| R111    | 1-247-879-00 | CARBON MELF | 100K | 5% | 1/5W |
| R112    | 1-247-849-00 | CARBON MELF | 5.6K | 5% | 1/5W |
| R113    | 1-247-831-00 | CARBON MELF | 1K   | 5% | 1/5W |
| R114    | 1-247-795-00 | CARBON MELF | 33   | 5% | 1/5W |
| R115    | 1-247-801-00 | CARBON MELF | 56   | 5% | 1/5W |
| R116    | 1-247-883-00 | CARBON MELF | 150K | 5% | 1/5W |
| R117    | 1-247-825-00 | CARBON MELF | 560  | 5% | 1/5W |
| R118    | 1-247-871-00 | CARBON MELF | 47K  | 5% | 1/5W |
| R119    | 1-247-873-00 | CARBON MELF | 56K  | 5% | 1/5W |
| R120    | 1-247-839-00 | CARBON MELF | 2.2K | 5% | 1/5W |
| R121    | 1-247-855-00 | CARBON MELF | 10K  | 5% | 1/5W |
| R122    | 1-247-855-00 | CARBON MELF | 1K   | 5% | 1/5W |
| R123    | 1-247-490-00 | CARBON MELF | 5.6K | 5% | 1/5W |
| R124    | 1-247-839-00 | CARBON MELF | 2.2K | 5% | 1/5W |
| *3R125  | 1-247-831-00 | CARBON MELF | 1K   | 5% | 1/5W |
| R126    | 1-247-839-00 | CARBON MELF | 2.2K | 5% | 1/5W |
| R127    | 1-249-041-00 | CARBON MELF | 2.2K | 5% | 1/5W |
| R128    | 1-247-787-00 | CARBON MELF | 15   | 5% | 1/5W |
| R129    | 1-247-783-00 | CARBON MELF | 10   | 5% | 1/5W |
| R130    | 1-247-855-00 | CARBON MELF | 10K  | 5% | 1/5W |
| R131    | 1-247-831-00 | CARBON MELF | 1K   | 5% | 1/5W |
| R132    | 1-247-839-00 | CARBON MELF | 2.2K | 5% | 1/5W |
| R133    | 1-247-821-00 | CARBON MELF | 390  | 5% | 1/5W |
| R134    | 1-247-795-00 | CARBON MELF | 33   | 5% | 1/5W |
| R135    | 1-247-827-00 | CARBON MELF | 680  | 5% | 1/5W |
| R136    | 1-247-827-00 | CARBON MELF | 680  | 5% | 1/5W |
| R137    | 1-247-875-00 | CARBON MELF | 68K  | 5% | 1/5W |
| R138    | 1-247-807-00 | CARBON      | 100  | 5% | 1/6W |
| R139    | 1-247-783-00 | CARBON      | 10   | 5% | 1/6W |
| R140    | 1-247-819-00 | CARBON MELF | 330  | 5% | 1/5W |
| R141    | 1-247-860-00 | CARBON MELF | 15K  | 5% | 1/5W |
| R142    | 1-247-855-00 | CARBON MELF | 10K  | 5% | 1/5W |
| R143    | 1-247-855-00 | CARBON MELF | 10K  | 5% | 1/5W |
| R144    | 1-247-855-00 | CARBON MELF | 10K  | 5% | 1/5W |
| R145    | 1-247-849-00 | CARBON MELF | 5.6K | 5% | 1/5W |
| R146    | 1-247-831-00 | CARBON MELF | 1K   | 5% | 1/5W |
| R147    | 1-247-831-00 | CARBON MELF | 1K   | 5% | 1/5W |
| R148    | 1-247-843-00 | CARBON MELF | 3.3K | 5% | 1/5W |

\*3 See page 86, since the resistance values are different by the type of IC4 and IC6.

ELECTRICAL PARTS

| Ref.No. | Part No.     | Description |      |    |      |
|---------|--------------|-------------|------|----|------|
| R149    | 1-247-837-00 | CARBON MELF | 1.8K | 5% | 1/5W |
| R150    | 1-247-867-00 | CARBON MELF | 33K  | 5% | 1/5W |
| *R151   | 1-247-831-00 | CARBON MELF | 1K   | 5% | 1/5W |
| R152    | 1-247-822-00 | CARBON MELF | 430  | 5% | 1/5W |
| R154    | 1-247-831-00 | CARBON MELF | 1K   | 5% | 1/5W |
| R153    | 1-247-855-00 | CARBON MELF | 10K  | 5% | 1/5W |
| R155    | 1-247-831-00 | CARBON MELF | 1K   | 5% | 1/5W |
| R160    | 1-247-855-00 | CARBON MELF | 10K  | 5% | 1/5W |
| R161    | 1-247-871-00 | CARBON MELF | 47K  | 5% | 1/5W |
| R162    | 1-247-855-00 | CARBON MELF | 10K  | 5% | 1/5W |
| R163    | 1-247-887-00 | CARBON MELF | 220K | 5% | 1/5W |
| R164    | 1-247-855-00 | CARBON MELF | 10K  | 5% | 1/5W |
| R165    | 1-247-879-00 | CARBON MELF | 100K | 5% | 1/5W |
| R166    | 1-247-879-00 | CARBON MELF | 100K | 5% | 1/5W |
| R167    | 1-247-903-00 | CARBON MELF | 1M   | 5% | 1/5W |
| R169    | 1-247-897-00 | CARBON MELF | 560K | 5% | 1/5W |
| R170    | 1-247-855-00 | CARBON MELF | 10K  | 5% | 1/5W |
| R171    | 1-247-855-00 | CARBON MELF | 10K  | 5% | 1/5W |
| R172    | 1-247-897-00 | CARBON MELF | 560K | 5% | 1/5W |
| R173    | 1-247-879-00 | CARBON MELF | 100K | 5% | 1/5W |
| R174    | 1-247-855-00 | CARBON MELF | 10K  | 5% | 1/5W |
| R175    | 1-247-879-00 | CARBON MELF | 100K | 5% | 1/5W |
| R176    | 1-247-855-00 | CARBON MELF | 10K  | 5% | 1/5W |
| R177    | 1-247-855-00 | CARBON MELF | 10K  | 5% | 1/5W |
| R178    | 1-247-849-00 | CARBON MELF | 5.6K | 5% | 1/5W |
| R179    | 1-247-867-00 | CARBON MELF | 33K  | 5% | 1/5W |
| R180    | 1-247-867-00 | CARBON MELF | 33K  | 5% | 1/5W |
| R181    | 1-247-825-00 | CARBON MELF | 560  | 5% | 1/5W |
| R182    | 1-247-825-00 | CARBON MELF | 560  | 5% | 1/5W |
| R183    | 1-247-847-00 | CARBON MELF | 4.7K | 5% | 1/5W |
| R184    | 1-247-847-00 | CARBON MELF | 4.7K | 5% | 1/5W |
| R185    | 1-247-879-00 | CARBON      | 100K | 5% | 1/6W |
| R186    | 1-247-891-00 | CARBON MELF | 330K | 5% | 1/5W |
| R187    | 1-247-891-00 | CARBON MELF | 330K | 5% | 1/5W |
| R188    | 1-247-887-00 | CARBON MELF | 220K | 5% | 1/5W |
| R189    | 1-247-847-00 | CARBON MELF | 4.7K | 5% | 1/5W |
| R190    | 1-247-807-00 | CARBON MELF | 100  | 5% | 1/5W |
| R191    | 1-247-863-00 | CARBON MELF | 22K  | 5% | 1/5W |
| R192    | 1-247-855-00 | CARBON MELF | 10K  | 5% | 1/5W |
| R193    | 1-247-887-00 | CARBON MELF | 220K | 5% | 1/5W |
| R194    | 1-247-855-00 | CARBON MELF | 10K  | 5% | 1/5W |
| R195    | 1-247-847-00 | CARBON MELF | 4.7K | 5% | 1/5W |
| R196    | 1-247-831-00 | CARBON MELF | 1K   | 5% | 1/5W |
| R197    | 1-247-855-00 | CARBON MELF | 10K  | 5% | 1/5W |
| R198    | 1-247-891-00 | CARBON MELF | 330K | 5% | 1/5W |
| R199    | 1-247-867-00 | CARBON      | 33K  | 5% | 1/6W |

ELECTRICAL PARTS

| Ref.No. | Part No.     | Description |      |    |      |
|---------|--------------|-------------|------|----|------|
| R200    | 1-247-861-00 | CARBON MELF | 18K  | 5% | 1/5W |
| R201    | 1-247-831-00 | CARBON MELF | 1K   | 5% | 1/5W |
| R202    | 1-247-855-00 | CARBON MELF | 10K  | 5% | 1/5W |
| R203    | 1-247-843-00 | CARBON MELF | 3.3K | 5% | 1/5W |
| R204    | 1-247-843-00 | CARBON MELF | 3.3K | 5% | 1/5W |
| R205    | 1-247-873-00 | CARBON MELF | 56K  | 5% | 1/5W |
| R206    | 1-247-859-00 | CARBON MELF | 15K  | 5% | 1/5W |
| R207    | 1-247-805-00 | CARBON MELF | 82   | 5% | 1/5W |
| R208    | 1-247-801-00 | CARBON MELF | 56   | 5% | 1/5W |
| R209    | 1-247-849-00 | CARBON MELF | 5.6K | 5% | 1/5W |
| R210    | 1-247-825-00 | CARBON MELF | 560  | 5% | 1/5W |
| R211    | 1-247-767-00 | CARBON MELF | 2.2  | 5% | 1/5W |
| R301    | 1-247-799-00 | CARBON MELF | 47   | 5% | 1/5W |
| R302    | 1-247-799-00 | CARBON MELF | 47   | 5% | 1/5W |
| R303    | 1-247-791-00 | CARBON MELF | 22   | 5% | 1/5W |
| R304    | 1-247-879-00 | CARBON MELF | 100K | 5% | 1/5W |
| R305    | 1-247-825-00 | CARBON MELF | 560  | 5% | 1/5W |
| R306    | 1-247-843-00 | CARBON MELF | 3.3K | 5% | 1/5W |
| R307    | 1-247-839-00 | CARBON MELF | 2.2K | 5% | 1/5W |
| R308    | 1-247-791-00 | CARBON MELF | 22   | 5% | 1/5W |
| R309    | 1-247-783-00 | CARBON MELF | 10   | 5% | 1/5W |
| R310    | 1-247-795-00 | CARBON MELF | 33   | 5% | 1/5W |
| R311    | 1-247-831-00 | CARBON MELF | 1K   | 5% | 1/5W |
| R312    | 1-247-804-00 | CARBON MELF | 75   | 5% | 1/5W |
| R313    | 1-247-823-00 | CARBON MELF | 470  | 5% | 1/5W |
| R314    | 1-247-879-00 | CARBON MELF | 100K | 5% | 1/5W |
| R315    | 1-247-783-00 | CARBON MELF | 10   | 5% | 1/5W |
| R316    | 1-247-783-00 | CARBON MELF | 10   | 5% | 1/5W |
| R317    | 1-247-813-00 | CARBON MELF | 180  | 5% | 1/5W |
| R318    | 1-247-855-00 | CARBON MELF | 10K  | 5% | 1/5W |
| R319    | 1-247-803-00 | CARBON MELF | 68   | 5% | 1/5W |
| R320    | 1-247-855-00 | CARBON MELF | 10K  | 5% | 1/5W |
| R321    | 1-247-791-00 | CARBON MELF | 22   | 5% | 1/5W |
| R322    | 1-247-871-00 | CARBON      | 47K  | 5% | 1/6W |
| R323    | 1-247-849-00 | CARBON      | 5.6K | 5% | 1/6W |
| R324    | 1-247-863-00 | CARBON      | 22K  | 5% | 1/6W |
| R325    | 1-247-891-00 | CARBON MELF | 330K | 5% | 1/5W |
| R326    | 1-247-815-00 | CARBON MELF | 220  | 5% | 1/5W |
| R401    | 1-247-791-00 | CARBON MELF | 22   | 5% | 1/5W |
| R402    | 1-247-855-00 | CARBON      | 10K  | 5% | 1/6W |
| R403    | 1-247-855-00 | CARBON MELF | 10K  | 5% | 1/5W |
| R501    | 1-247-831-00 | CARBON MELF | 1K   | 5% | 1/5W |
| R502    | 1-247-831-00 | CARBON MELF | 1K   | 5% | 1/5W |
| R503    | 1-247-831-00 | CARBON MELF | 1K   | 5% | 1/5W |
| R504    | 1-247-831-00 | CARBON MELF | 1K   | 5% | 1/5W |

## ELECTRICAL PARTS

| Ref.No. | Part No.     | Description |      |    |      |
|---------|--------------|-------------|------|----|------|
| R505    | 1-247-831-00 | CARBON MELF | 1K   | 5% | 1/5W |
| R506    | 1-247-831-00 | CARBON MELF | 1K   | 5% | 1/5W |
| R507    | 1-247-831-00 | CARBON MELF | 1K   | 5% | 1/5W |
| R508    | 1-247-831-00 | CARBON MELF | 1K   | 5% | 1/5W |
| R509    | 1-247-879-00 | CARBON MELF | 100K | 5% | 1/5W |
| R510    | 1-247-831-00 | CARBON MELF | 1K   | 5% | 1/5W |
| R511    | 1-247-831-00 | CARBON MELF | 1K   | 5% | 1/5W |
| R512    | 1-247-831-00 | CARBON MELF | 1K   | 5% | 1/5W |
| R513    | 1-247-855-00 | CARBON MELF | 10K  | 5% | 1/5W |
| R514    | 1-247-831-00 | CARBON MELF | 1K   | 5% | 1/5W |
| R515    | 1-247-831-00 | CARBON MELF | 1K   | 5% | 1/5W |
| R516    | 1-247-831-00 | CARBON MELF | 1K   | 5% | 1/5W |
| R517    | 1-247-831-00 | CARBON MELF | 1K   | 5% | 1/5W |
| R518    | 1-247-831-00 | CARBON MELF | 1K   | 5% | 1/5W |
| R519    | 1-247-903-00 | CARBON MELF | 1M   | 5% | 1/5W |
| R520    | 1-247-903-00 | CARBON MELF | 1M   | 5% | 1/5W |
| R521    | 1-247-903-00 | CARBON MELF | 1M   | 5% | 1/5W |
| R522    | 1-247-903-00 | CARBON MELF | 1M   | 5% | 1/5W |
| R523    | 1-247-903-00 | CARBON MELF | 1M   | 5% | 1/5W |
| R524    | 1-247-903-00 | CARBON MELF | 1M   | 5% | 1/5W |
| R525    | 1-247-903-00 | CARBON MELF | 1M   | 5% | 1/5W |
| R526    | 1-247-903-00 | CARBON MELF | 1M   | 5% | 1/5W |
| R527    | 1-247-903-00 | CARBON MELF | 1M   | 5% | 1/5W |
| R528    | 1-247-903-00 | CARBON MELF | 1M   | 5% | 1/5W |
| R529    | 1-247-903-00 | CARBON MELF | 1M   | 5% | 1/5W |
| R530    | 1-247-903-00 | CARBON MELF | 1M   | 5% | 1/5W |
| R531    | 1-247-903-00 | CARBON MELF | 1M   | 5% | 1/5W |
| R532    | 1-247-903-00 | CARBON MELF | 1M   | 5% | 1/5W |
| R533    | 1-247-809-00 | CARBON MELF | 120  | 5% | 1/5W |
| R534    | 1-247-855-00 | CARBON MELF | 10K  | 5% | 1/5W |
| R535    | 1-247-863-00 | CARBON MELF | 22K  | 5% | 1/5W |
| R536    | 1-247-903-00 | CARBON MELF | 1M   | 5% | 1/5W |
| R537    | 1-247-879-00 | CARBON MELF | 100K | 5% | 1/5W |
| R538    | 1-247-855-00 | CARBON MELF | 10K  | 5% | 1/5W |
| R539    | 1-247-879-00 | CARBON MELF | 100K | 5% | 1/5W |
| R540    | 1-247-903-00 | CARBON MELF | 1M   | 5% | 1/5W |
| R541    | 1-247-807-00 | CARBON MELF | 100  | 5% | 1/5W |
| R542    | 1-247-879-00 | CARBON MELF | 100K | 5% | 1/5W |
| R543    | 1-247-879-00 | CARBON MELF | 100K | 5% | 1/5W |
| R544    | 1-247-879-00 | CARBON MELF | 100K | 5% | 1/5W |
| R545    | 1-247-903-00 | CARBON MELF | 1M   | 5% | 1/5W |
| R546    | 1-247-903-00 | CARBON MELF | 1M   | 5% | 1/5W |
| R547    | 1-247-883-00 | CARBON MELF | 150K | 5% | 1/5W |
| R548    | 1-247-879-00 | CARBON MELF | 100K | 5% | 1/5W |
| R549    | 1-247-831-00 | CARBON MELF | 1K   | 5% | 1/5W |

## ELECTRICAL PARTS

| Ref.No. | Part No.     | Description                             |      |    |      |
|---------|--------------|---|------|----|------|
| R550    | 1-247-807-00 | CARBON MELF                             | 100  | 5% | 1/5W |
| R551    | 1-247-879-00 | CARBON MELF                             | 100K | 5% | 1/5W |
| R552    | 1-247-879-00 | CARBON MELF                             | 100K | 5% | 1/5W |
| R553    | 1-247-879-00 | CARBON MELF                             | 100K | 5% | 1/5W |
| R554    | 1-247-879-00 | CARBON MELF                             | 100K | 5% | 1/5W |
| R555    | 1-247-883-00 | CARBON MELF                             | 150K | 5% | 1/5W |
| R556    | 1-247-903-00 | CARBON MELF                             | 1M   | 5% | 1/5W |
| R557    | 1-247-903-00 | CARBON MELF                             | 1M   | 5% | 1/5W |
| R558    | 1-247-831-00 | CARBON MELF                             | 1K   | 5% | 1/5W |
| R559    | 1-247-831-00 | CARBON MELF                             | 1K   | 5% | 1/5W |
| R560    | 1-247-831-00 | CARBON MELF                             | 1K   | 5% | 1/5W |
| R601    | 1-247-831-00 | CARBON MELF                             | 1K   | 5% | 1/5W |
| R602    | 1-247-843-00 | CARBON                                  | 3.3K | 5% | 1/6W |
| R603    | 1-247-839-00 | CARBON MELF                             | 2.2K | 5% | 1/5W |
| R604    | 1-247-831-00 | CARBON MELF                             | 1K   | 5% | 1/5W |
| R605    | 1-247-843-00 | CARBON MELF                             | 3.3K | 5% | 1/5W |
| R606    | 1-247-843-00 | CARBON MELF                             | 3.3K | 5% | 1/5W |
| R607    | 1-247-867-00 | CARBON MELF                             | 33K  | 5% | 1/5W |
| R608    | 1-247-855-00 | CARBON MELF                             | 10K  | 5% | 1/5W |
| R609    | 1-247-839-00 | CARBON MELF                             | 2.2K | 5% | 1/5W |
| R610    | 1-247-838-00 | CARBON MELF                             | 120K | 5% | 1/5W |
| R611    | 1-247-831-00 | CARBON MELF                             | 1K   | 5% | 1/5W |
| R612    | 1-247-871-00 | CARBON MELF                             | 47K  | 5% | 1/5W |
| R613    | 1-247-823-00 | CARBON                                  | 470  | 5% | 1/6W |
| R701    | 1-247-877-00 | CARBON MELF                             | 82K  | 5% | 1/5W |
| R702    | 1-247-871-00 | CARBON                                  | 47K  | 5% | 1/6W |
| R703    | 1-247-871-00 | CARBON                                  | 47K  | 5% | 1/6W |
| R704    | 1-247-831-00 | CARBON MELF                             | 1K   | 5% | 1/5W |
| S1      | 1-570-056-11 | SWITCH, SLIDE (TONE)                    |      |    |      |
| S301    | 1-554-222-00 | SWITCH, SLIDE (AM ATT)                  |      |    |      |
| S302    | 1-554-222-00 | SWITCH, SLIDE (MAIN POWER)              |      |    |      |
| S501    | 1-554-061-00 | SWITCH, SLIDE (LOCK-SLOW-FAST)          |      |    |      |
| S502    | 1-554-061-00 | SWITCH, SLIDE (POWER)                   |      |    |      |
| T1      | 1-426-136-00 | TRANSFORMER, HF                         |      |    |      |
| T2      | 1-459-572-11 | COIL (WITH CORE)                        |      |    |      |
| T3      | 1-459-574-11 | COIL (WITH CORE)                        |      |    |      |
| T301    | 1-426-194-11 | TRANSFORMER, HIGH-FREQUENCY             |      |    |      |
| T701    | 1-406-129-11 | COIL                                    |      |    |      |
| TH      | 1-806-716-00 | THERMISTOR                              |      |    |      |
| VR1     | 1-230-652-11 | RES, VAR, SLIDE 20K (AM RF GAIN)        |      |    |      |
| VR2     | 1-230-607-11 | RES, VAR, SLIDE 20K (VOLUME)            |      |    |      |
| VT1     | 1-226-773-00 | RES, ADJ, METAL GLAZE 22K (SSB)         |      |    |      |
| VT2     | 1-226-773-00 | RES, ADJ, METAL GLAZE 22K (UPPED/LOWER) |      |    |      |

ELECTRICAL PARTS

| Ref.No. | Part No.     | Description         |
|---------|--------------|---------------------|
| X1      | 1-567-050-31 | FILTER, CERAMIC     |
| X2      | 1-567-386-11 | OSCILLATOR, CRYSTAL |
| X3      | 1-567-385-11 | OSCILLATOR, CRYSTAL |
| X501    | 1-567-098-00 | VIBRATOR, CRYSTAL   |
| X601    | 1-567-387-11 | VIBRATOR, CERAMIC   |

ACCESSORY & PACKING MATERIAL

| Part No.      | Description   |
|---------------|---|
| ▲1-463-330-00 | (US).....ADAPTOR, AC: AC-120W   |
| ▲1-463-331-11 | (Canadian)...ADAPTOR, AC: AC-120W                                       |
| ▲1-463-373-XX | (EXCEPT US,Canadian AUS)  |
| ▲1-463-633-00 | (UK).....ADAPTOR, AC: AC-140W   |
| 1-504-059-11  | MAGNETIC EARPHONE(ME-20H)   |
| 1-557-787-11  | CONNECTOR, CONNECTION   |
| *3-307-051-01 | CARDBOARD (A)   |
| 3-701-617-00  | BAG, POLYETHYLENE, STANDARD   |
| 3-701-622-01  | (E,AEP,UK)...BAG, PLASTIC   |
| 3-887-278-00  | (US,Canadian)...BOOK, RADIO WAVE GUIDE                                  |
| 3-887-285-04  | (E(MIDDLE EASTS(EXCEPT ISRAEL),SAUDI ARABIA)...BOOK, RADIO GUIDE        |
| 3-887-291-01  | SHEET, PROTECTION   |
| 3-893-802-01  | (E(EXCEPT ISRAEL),AEP,UK,AUS)...BOOK, GUIDE, WAVE                       |
| 3-894-549-01  | BELT, CARRYING  |
| 3-894-555-01  | (US,Canadian,AU)...HOLDER, ACCESSORY                                    |
| 3-894-556-01  | (E(EXCEPT MIDDLE EASTS AND SAUDI ARABIA) ...INDIVIDUAL CARTON           |
| 3-894-557-02  | CUSHION   |
| 3-894-558-01  | SHEET, MEMORANDUM   |
| 3-894-567-01  | SHEET, INFORMATION  |
| 3-894-568-01  | (US,Canadian)...INDIVIDUAL CARTON                                       |
| 3-894-569-01  | (AEP,UK,E).....INDIVIDUAL CARTON  |
| 3-894-577-01  | (EXCEPT US,Canadian,AUS)..HOLDER, ACCESSORY                             |
| 3-894-592-01  | SPACER (INITIAL SETS ONLY)  |
| 3-990-021-11  | (AEP(EXCEPT FEDERAL REPUBLIC OF GERMANY), UK,AUS)...MANUAL, INSTRUCTION |
| 3-990-021-21  | (US,Canadian)...MANUAL, INSTRUCTION                                     |
| 3-990-021-41  | (AEP).....MANUAL, INSTRUCTION   |
| 3-990-021-51  | (E(MIDDLE EASTS,SAUDE ARABIA))...MANUAL, INSTRUCTION                    |
| 3-993-317-21  | (US,Canadian)...INSTRUCTION   |
| X-3891-802-0  | ANTENNA ASSY, WIRE, AM  |
| X-3891-802-0  | ANTENNA, WIRE (AM)  |

The components identified by shading and mark ▲ are critical for safety. Replace only with part number specified.

Les composants identifiés par une trame et une marque ▲ sont critiques pour la sécurité. Ne les remplacer que par une pièce portant le numéro spécifié.

## NOTES ON SERVICE

The replacement IC CX7961 for IC4 and IC6 has come to supply-end, so IC CX7961A is available instead of CX7961. When replacing IC4 and/or IC6, following modifications should be performed.

|          | Former       | New          |
|----------|--------------|--------------|
| Type No. | CX7961       | CX7961A      |
| Part No. | 8-757-961-00 | 8-757-961-10 |

### Modification

- 1) When replacing IC4, modify as follows.
  - C112 1 $\mu$ F/16V  $\rightarrow$  0.056 $\mu$ F/50V: 1-136-162-00 (METALIZED FILM)
  - R102 2.2k $\Omega$   $\rightarrow$  15k $\Omega$ : 1-249-431-11 (CARBON, SMALL)
  - R151 1.0k $\Omega$   $\rightarrow$  220 $\Omega$ : 1-249-409-11 (CARBON, SMALL)
  - Add a 3.3 $\mu$ F/4V capacitor (C181) paralleled with R141.: 1-135-103-00 (CRIP, TANTAL ELECT)
- 2) When replacing IC6, modify as follows.
  - C138 0.82 $\mu$ F/16V  $\rightarrow$  0.056 $\mu$ F/50V: 1-136-162-00 (METALIZED FILM)
  - R125 1.0k $\Omega$   $\rightarrow$  5.6k $\Omega$ : 1-249-426-00 (CARBON, SMALL)
  - R151 1.0k $\Omega$   $\rightarrow$  220 $\Omega$ : 1-247-815-00 (CARBON, SMALL)
  - Add a 3.3 $\mu$ F/4V capacitor (C181) paralleled with R141.: 1-135-103-00

### — PARTS LOCATION — [ MAIN BOARD ]

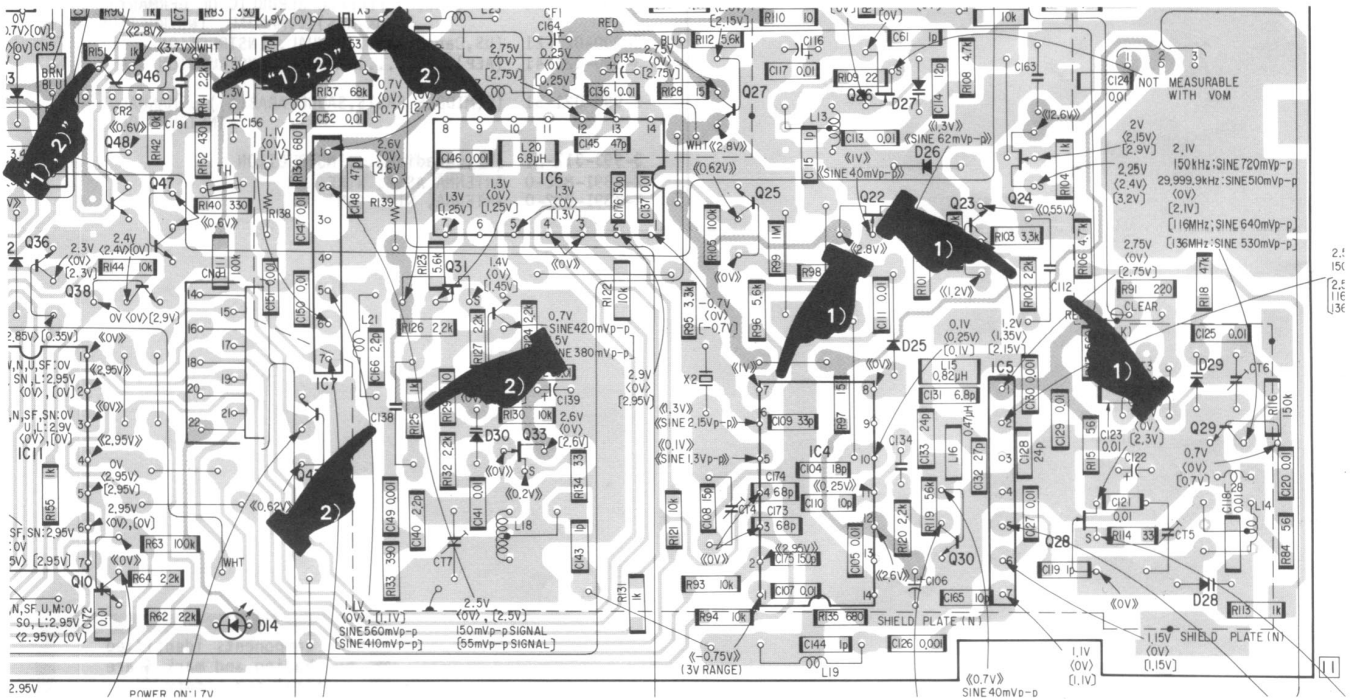

Sony Corporation

9-951-647-12  
(including 9-951-647-91)

— 86 —

English  
88A0205-1(3)  
Printed in Japan  
© 1985. 3