

# HCD-H170/H170K/H700

## SERVICE MANUAL

HCD-H170, HCD-H170K and HCD-H700 are the tuner, deck, CD and amplifier section in FH-B170/B177, FH-B170K and MHC-700 respectively.

Dolby noise reduction manufactured under license from Dolby Laboratories Licensing Corporation. "DOLBY" and the double-D symbol  are trademarks of Dolby Laboratories Licensing Corporation.



**AEP Model**  
HCD-H170/HCD-H700  
**UK Model**  
HCD-H700  
**E Model**  
HCD-170/HCD-170K  
**Australian Model**  
**East European Model**  
HCD-H170

PHOTO: HCD-H170K

### SPECIFICATIONS

#### Tuner section

FM stereo, FM/AM superheterodyne tuner

#### FM tuner section

Tuning range 65.0-74.0MHz (East European)  
87.5-108MHz  
Antenna FM lead antenna (HCD-H700)  
Telescopic antenna (HCD-H170, H170K)  
Antenna terminals 75 ohm unbalanced  
Intermediate frequency 10.7 MHz

#### AM tuner section

Tuning range  
AEP, Germany, Italian, East European  
MW: 531 — 1,602 kHz  
LW: 153 — 279 kHz  
E, Saudi Arabia, Australian model  
MW: 531 — 1,602 kHz  
SW: 5.95 — 17.9 MHz  
Italian model  
MW : 522-1.611kHz  
LW : 144-288kHz  
Antenna AM loop antenna  
External antenna terminals  
Intermediate frequency 450 kHz

#### Amplifier section

Continuous RMS power output  
25 + 25 watts (6 ohms at 1 kHz, DIN)  
Peak music power output  
(E, Saudi Arabia, Australian model)  
280 watts (4 speakers driven)

CD Section	Model Name Using Similar Mechanism		NEW
	CD Mechanism Name		CDM13B-5BD4A
	Base Unit Name		BU-5BD4A
DECK Section	Model Name Using Similar Mechanism		NEW
	Tape Transport Mechanism	DECK A	TCM-190RA13A
	Type	DECK B	TCM-190RB22A

#### Inputs

For HCD-H170K

MIX MIC 1 and MIX MIC 2 (minijack):  
Sensitivity 1 mV, impedance 600 ohms  
PHONO (phono jack):  
sensitivity 5 mV, impedance 47 kilohms

For HCD-H700

HCD-H170 (AEP, Germany, Italian, East European)  
MIX MIC (minijack):  
Sensitivity 1 mV, impedance 600 ohms  
PHONO (phono jack):  
sensitivity 5 mV, impedance 47 kilohms

For HCD-H170

(E, Saudi Arabia, Australian)

MIX MIC (minijack):  
Sensitivity 1 mV, impedance 600 ohms  
VIDEO/AUX (phono jack): sensitivity 5 mV, impedance 47 kilohms  
HEADPHONES (stereo minijack): accept headphones of 8 ohms or more.  
SPEAKERS: accept impedance of 6 to 16 ohms.

#### Outputs

#### Compact disc player section

System Compact disc digital audio system  
Laser Semiconductor laser (λ = 780 nm)  
Emission duration: Continuous  
Laser output Max. 44.6 μW\*  
\* This output is the value measured at distance of about 200 mm from the objective lens surface on the Optical Pick-up Block.  
Signal-to noise ratio More than 95dB  
Dynamic range More than 90 dB

#### Cassette deck section

Recording system 4-track 2-channel stereo  
Frequency response (DOLBY NR OFF)  
60 — 13,000 Hz (± 3 dB), using TYPE I cassette (Sony HF-S)  
60 — 14,000 Hz (± 3 dB), using TYPE II cassette  
Wow and flutter 0.1% WRMS ± 0.3% (DIN)

- continued on next page -

COMPACT DISC DECK RECEIVER  
**SONY**®



TABLE OF CONTENTS

**Speaker section**

Speaker system	3 way system
Speaker units	Woofer: 13 cm dia., cone type Tweeter: 5 cm dia., cone type Super tweeter: 2 cm dia., dome type
Enclosure	Bass reflex
Frequency range	60 Hz — 20 kHz
Sensitivity	88 dB/w/m
Rated impedance	6 ohms
Dimensions	Approx. 195 x 285 x 230 mm (7 5/8 x 11 1/4 x 9 inches)
Weight	Approx. 3.0 kg (6 lb 10 oz) net per speaker

**General**

Desti-nation	Power requirements	Power consumption
AEP, Italian, Germany, East European model	220-230V AC, 50/60 Hz	80 watts
UK model	240V AC, 50 Hz	160 watts
E, Saudi Arabia, Australian model	100V-120V or 220V-240V AC adjustable, 50/60Hz	80 watts

Dimensions  
 Approx. 225 x 285 x 268 mm (w/h/d)  
 (8 7/8 x 11 1/4 x 10 5/8 inches)  
 incl. projecting parts and controls

Weight  
 Approx. 6.2 kg (13 lb 11 oz)

Accessories supplied  
 AM loop antehna (1)  
 Remote commander (1)  
 Sony SUM-3 (NS) batteries (2)  
 FM lead antenna (1) (HCD-H700 only)  
 Speaker cords (2)  
 (HCD-H700, except for the UK model)

Design and specifications subject to change without notice.

**Note**  
 This appliance conforms with EEC Directive 87/308/EEC regarding interference suppression.

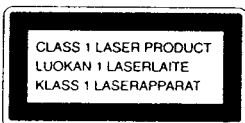

This appliance is classified as a CLASS 1 LASER product. The CLASS 1 LASER PRODUCT label is located on the rear exterior.

<u>Section</u>	<u>Title</u>	<u>Page</u>
<b>1. SERVICING NOTES</b>		3
<b>2. GENERAL</b>		5
<b>3. DISASSEMBLY</b>		
3-1. Case		25
3-2. Power Block		25
3-3. Main Board		26
3-4. CD Mechanism Block		26
3-5. TC Mechanism Block		27
3-6. Volume/MIC HP/Display/SW Board		27
<b>4. MECHANICAL ADJUSTMENTS</b>		28
<b>5. ELECTRICAL ADJUSTMENTS</b>		28
<b>6. DIAGRAMS</b>		
6-1. Semiconductor Lead Layouts		34
6-2. Circuit Boards Location		35
6-3. Printed Wiring Boards —Main Section—		37
6-4. Schematic Diagram —Main Section—		41
6-5. Schematic Diagram —Sub Section—		46
6-6. Printed Wiring Boards —Sub Section—		51
6-7. Printed Wiring Boards —Display Section—		56
6-8. Schematic Diagram —Display Section—		59
6-9. Schematic Diagram —BD Section—		62
6-10. IC Pin Description		67
<b>7. EXPLODED VIEWS</b>		
7-1. Case, Power Section		71
7-2. Front Panel, Main Board Section		72
7-3. MD Chassis Section		73
7-4. Mechanism Deck Section (1)		74
7-5. Mechanism Deck Section (2)		75
7-6. CD Section (1)		76
7-7. CD Section (2)		77
<b>8. ELECTRICAL PARTS LIST</b>		78

**SAFETY-RELATED COMPONENT WARNING!!**

COMPONENTS IDENTIFIED BY MARK OR DOTTED LINE WITH MARK ON THE SCHEMATIC DIAGRAMS AND IN THE PARTS LIST ARE CRITICAL TO SAFE OPERATION. REPLACE THESE COMPONENTS WITH SONY PARTS WHOSE PART NUMBERS APPEAR AS SHOWN IN THIS MANUAL OR IN SUPPLEMENTS PUBLISHED BY SONY.

## SECTION 1 SERVICING NOTES

### MODEL IDENTIFICATION

— Specification Labels —

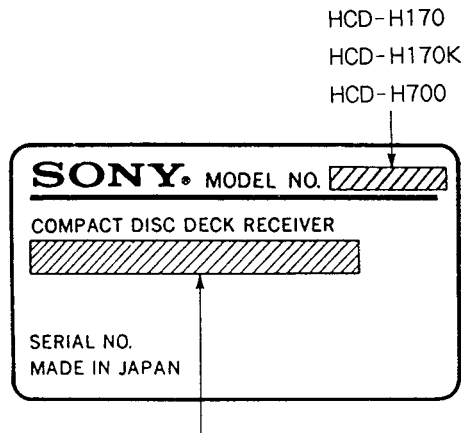

AEP, Germany, Italian, East European model : AC : 220-230V~50/60Hz 80W  
 E, Saudi Arabia Australian model : AC : 100-120/220-240~50/60Hz 80W  
 UK model : AC : 240V~50Hz 160W

#### On operating voltage

Before operating the stereo system, check that the operating voltage of your system is identical with the voltage of your local power supply.

AEP, Italian, Germany, East European model	220-230V AC, 50/60 Hz
UK model	240V AC, 50 Hz
Saudi Arabia, Australian model	100V-120V/220V-240V AC, adjustable, 50/60Hz

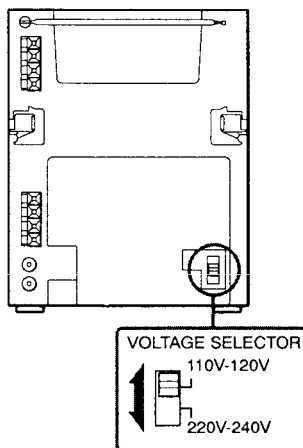

#### Battery Installation

Install the two R6 (size AA) batteries in the supplied remote commander for remote control operation.

#### Battery life

About half a year of normal operation can be expected when using the Sony SUM-3 (NS) batteries. When the batteries are exhausted, the commander cannot operate the stereo system. When this happens, replace both batteries with new ones.

#### To avoid battery leakage

If the commander is not to be used for a long time, remove the batteries to avoid damage caused by battery leakage and corrosion.

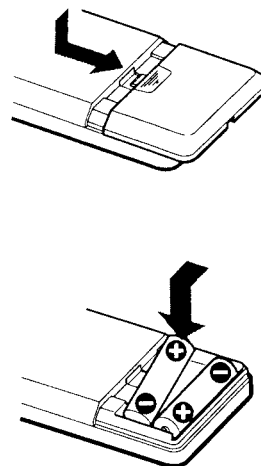

**LASER DIODE AND FOCUS SEARCH OPERATION CHECK**

1. Make POWER switch on with no disc inserted and disc table closed.
2. Confirm that the following operation is performed while observing the objecting lens.

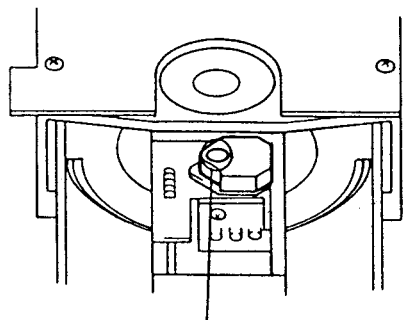

- ① Confirm that laser beam is spread.
- ② Up and down motion of the objective lens. (3 times)

**NOTES ON HANDLING THE OPTICAL PICK-UP BLOCK OR BASE UNIT**

The laser diode in the optical pick-up block may suffer electrostatic break-down because of the potential difference generated by the charged electrostatic load, etc. on clothing and the human body.

During repair, pay attention to electrostatic break-down and also use the procedure in the printed matter which is included in the repair parts.

The flexible board is easily damaged and should be handled with care.

**NOTES ON LASER DIODE EMISSION CHECK**

The laser beam on this model is concentrated so as to be focused on the disc reflective surface by the objective lens in the optical pick-up block. Therefore, when checking the laser diode emission, observe from more than 30 cm away from the objective lens.

**HOW TO OPEN THE DISC TRAY WHEN POWER SWITCH TURNS OFF**

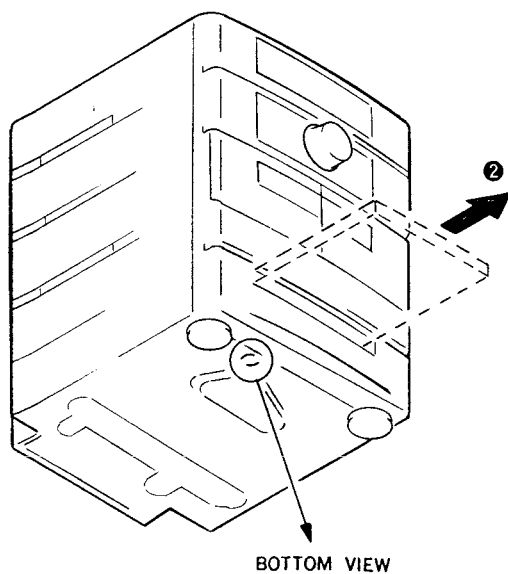

- (1) Insert to ① for tapering driver, etc., and turn in the direction of arrow OFF. (Disc tray open)
- (2) Tray as come out little of front panel, pull out in the direction of arrow ② by hand.

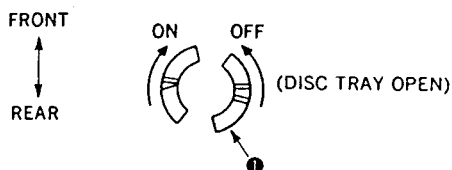

## SECTION 2 GENERAL

This section is extracted from instruction manual.

### Parts Identification

Refer to the pages indicated in parenthesis for use of the buttons.

#### Tuner Section A

- 1 POWER ON/STANDBY switch
- 2 Remote sensor
- 3 TIMER button (100)
- 4 TIMER REC button (104)
- 5 Display window
- 6 PRESET/TIMER +/- buttons (52, 100, 104)
- 7 BAND button (48)
- 8 MEMORY/NEXT button (52, 100, 104)
- 9 STEREO/MONO button (50)
- 10 TUNING +/- buttons (48)

#### Amplifier Section B

- 1 MIC (microphone) 1 and 2 LEVEL controls (only for FH-B170K) (112)
- 2 MIX MIC 1 and 2 jacks (for FH-B170K) (112)  
MIX MIC jack (for other models) (112)
- 3 HEADPHONES jack (22)
- 4 ECHO LEVEL control (only for FH-B170K) (112)
- 5 MPX (multiplex) button and indicator (only for FH-B170K) (114)
- 6 VOLUME control (22)
- 7 PRESET button and indicators (62)
- 8 FUNCTION button
- 9 DBFB (Dynamic Bass Feed Back) button and indicator (22)
- 10 KARAOKE PON (vocal reduction) button and indicator (for FH-B170K) (114)  
S-SUR (simulated surround) button (for other models) (22)
- 11 EQ (equalizer ON/OFF) button (62)

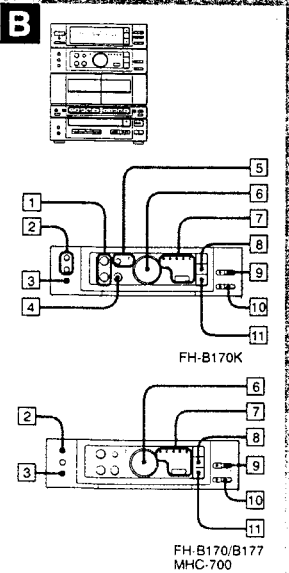
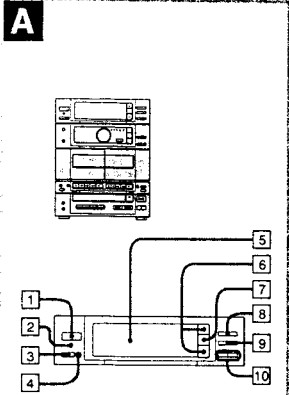

134

### Parts Identification

#### Cassette Deck Section C

- 1 Cassette holders
- 2 HIGH SPEED button (72)
- 3 CD SYNC button (86, 94, 98)
- 4 EJECT ▲ button (for deck A) (56)
- 5 DIRECTION MODE selector (56)
- 6 Tape operating buttons (for deck A and B)
  - ▶▶ (fast wind and AMS\*) button (56)
  - ◀◀ (rewind and AMS\*) button (56)
  - ▷: Forward play button and direction indicator (56)
  - ◁: Reverse play button and direction indicator (56)
  - : Stop button (56)
- 7 REC ● (recording) button
- 8 PAUSE II button (56)
- 9 EJECT ▲ button (for deck B) (66)
- 10 DOLBY NR selector (56)

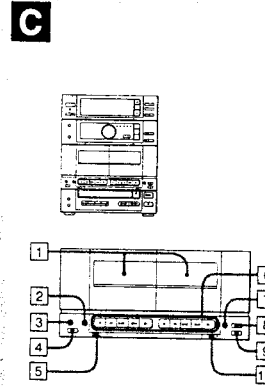

#### CD Player Section D

- 1 Disc tray (24)
- 2 CHECK button (42)
- 3 EDIT/TIME FADE button (78, 90)
- 4 PLAY MODE buttons
  - CONTINUE button (38)
  - SHUFFLE button (38)
  - PROGRAM button (40, 96)
- 5 OPEN/CLOSE button (24)
- 6 ▶II (play/pause) button (24)
- 7 ■ (stop) button (24)
- 8 ◀◀▶▶ (manual search/AMS\*) buttons (26, 96)
- 9 REPEAT button (32)

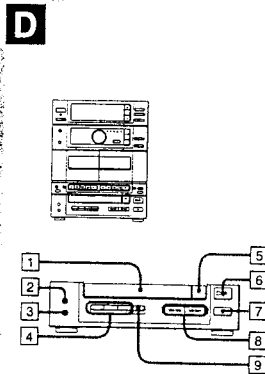

\* AMS is the abbreviation of Automatic Music Sensor.

136

## Parts Identification

**E**

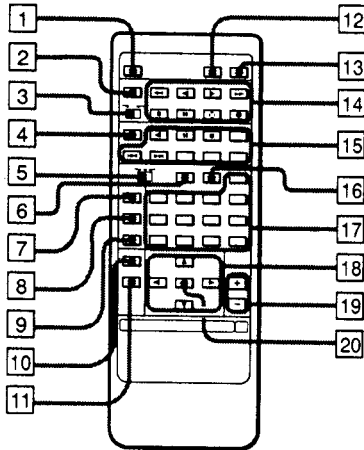

### Remote Commander

- 1 CLOCK DISPLAY button (20)
- 2 TAPE function button
- 3 DECK A/B selector
- 4 CD function button
- 5 TUNER/EQ/CD selector
- 6 CHECK button (42)
- 7 TUNER function button
- 8 VIDEO function button
- 9 PHONO function button
- 10 MEMORY button (66)
- 11 DBFB button (22)
- 12 SLEEP button (110)
- 13 SYSTEM POWER button
- 14 Tape operating buttons
- 15 CD player operating buttons
- 16 CLEAR button (38)
- 17 TUNER/EQ/CD numeric buttons (28, 62)
- 18 CURSOR CONTROL buttons (64)
- 19 VOL +/- (volume control) buttons (22)
- 20 EQ button (62)

## How to Use This Manual

This manual applies MHC-700 for Europe and the U.K., FH-B177 for Europe, FH-B170 for the U.S.A. and other countries, and FH-B170K for other countries. The differences between them are indicated below.

Destination	USA	Europe and UK	Other countries
Receivable band	AM/FM	FM/LW/ MW	FM/MW/ SW
PHONO jack	No	Yes	No
VIDEO/AUX jack	Yes	No	Yes

**Equipped antenna for FM reception**  
 MHC-700: FM lead antenna  
 FH-B177, B170 and B170K: Telescopic antenna

In this manual, the illustrations of the unit are illustrated as FH-B177.

### How this manual is composed

- Please read the instructions in this manual referring to the illustrations.
- The letters in the illustrations correspond to those in the text: e.g. Speaker Cord Connection **A**
  - The step numbers in the illustrations correspond to those in the text.
  - Use the page numbers in "Parts Identification" at the end of this manual as an index to find out how to use the buttons and controls.

## Overview

### Tuner section

- The receivable band stations differ depending on the model where it is destined for. Please see the table in "How to Use this Manual".
- You can store up to 30 stations (for the USA model) or 40 stations (except for the USA model).

### Amplifier section

- DBFB (Dynamic Bass Feedback) system reinforces bass sound.
- You can easily adjust the music to your taste by selecting from 5 factory-preset graphic equalizer settings.
- You can store up to 5 individual settings of graphic equalizer.
- You can select directly the desired program source just by pressing the operation button (BAND, PRESET/TIMER + / - or TUNING + / -) to select the tuner. PH to select the CD player, and < or > to select the cassette deck on the program source equipment. (Automatic Source Selection)

### CD player section

- You can enjoy listening in various playing modes.
- Edit functions allow you to program selections automatically to fit in a desired duration.

### Cassette deck section

- Auto-reverse decks enable repeated playback of both sides of the cassette.
- CD synchro function enables easy recording of a CD.
- Double decks enable tape dubbing and continuous playback.

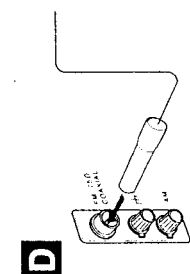
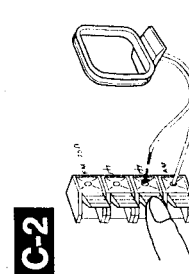
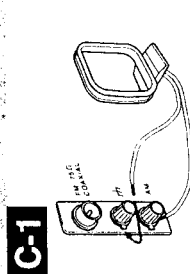
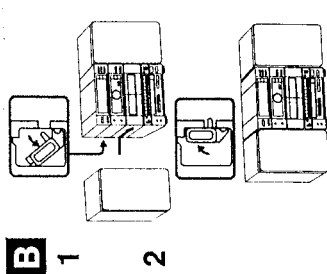
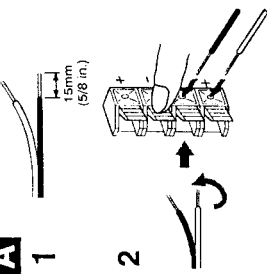

## Connections

### Notes on connection

- Connect the AC power cord last.
- Cord plugs and jacks are color coded. Red plugs and jacks are for the right channel (R) and white ones for the left channel (L).

### Speaker Cord Connection **A**

- Strip 15 mm (5/8 inches) of the speaker cord coating from the end of the cord.
- Connect the right speaker to R, with the red cord to + and the black cord to -.
- Connect the left speaker to L, with the red cord to + and the black cord to -.

### To attach the speakers to the main unit - For FH-B177, B170 and B170K only **B**

- Unlock the stopper and slide the speaker so that it hooks to the system.
- Lock the stopper.

### AM Loop Antenna Connection **C**

For the European and U.K. model **C-1**

### For the models for other countries **C-2**

Connect the supplied loop antenna to the AM and  $h_1$  terminals.

### FM Lead Antenna Connection (MHC-700 only) **D**

Connect the supplied FM lead antenna to the FM 75Ω terminal and extend horizontally.

## Connections

### For Better FM Reception **E**

#### For the European and U.K. model

**E-1** Connect the outdoor FM antenna to the FM 75 Ω terminal, using 75-ohm coaxial cable and IEC standard socket connector.

#### For the models for other countries

**E-2** Connect the outdoor FM antenna to the FM 75 Ω and *h* terminals, using 75-ohm coaxial cable.

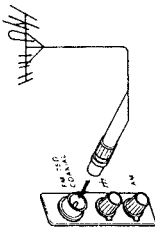

**E-1**

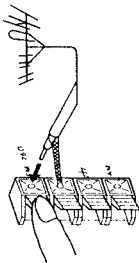

**E-2**

### For Better AM Reception **F**

#### For the European and U.K. model

**F-1** Use the 6- to 15-meter (20- to 50-foot) insulated wire for connecting the terminal. Connect the *h* terminal to a good ground.

#### For the models for other countries

**F-2** Use the 6- to 15-meter (20- to 50-foot) insulated wire for connecting the terminal. Connect the *h* terminal to a good ground.

#### Important

When you use an external antenna, be sure to ground it against lightning. Never connect the ground wire to a gas pipe. Doing so is extremely dangerous.

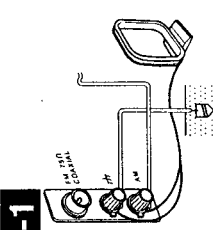

**F-1**

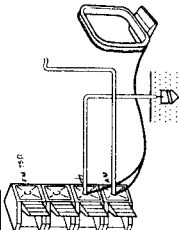

**F-2**

### G

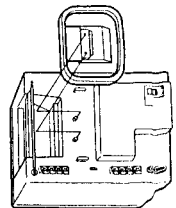

**G**

## Connections

### Adding Other Components to the System **A**

#### Turntable system **A-1**

(For the European and U.K. model) You can connect a turntable system to the PHONO jacks. To listen to the turntable system, press FUNCTION on the front panel until "PHONO" appears on the display.

#### VTR **A-2**

(For the model for other countries) You can connect a VTR, etc. to the VIDEO/AUX jacks. To listen to the connected equipment, press FUNCTION on the front panel until "VIDEO/AUX" appears on the display.

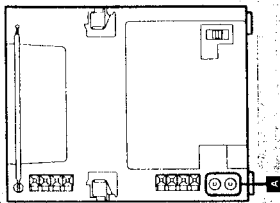

**A-1**

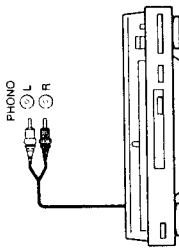

**A-2**

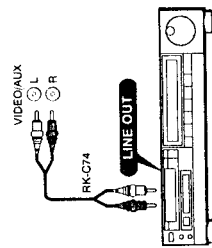

## Clock Setting

### Setting the Clock

Example: Set to 9:25 in the morning.

- 1 Press **TIMER** and **TIMER REC** at the same time.
- 2 Set the hour with **PRESET/TIMER** - or + button.
- 3 Press **MEMORY/NEXT**.
- 4 Set the minute with **PRESET/TIMER** - or + button.

- 5 Press **MEMORY/NEXT**. The clock starts operating.

### Information on the time

The European and U.K. model shows the time in 24-hour cycle. The model for other countries shows the time in 12-hour cycle.  
AM 12:00 = midnight  
PM 12:00 = noon

### When a power interruption occurs

The clock and timer settings are all erased, and "0:00" ("AM 12:00") will flash on the display.

### To change the frequency display to the time display

Press **CLOCK DISPLAY** on the remote commander. The time is displayed for about 4 seconds, then the time display changes into the frequency display.

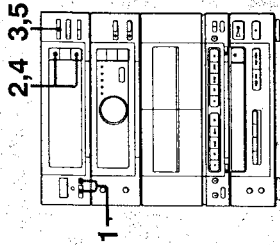

**1**

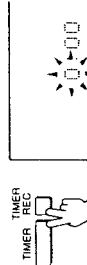

**2**



**3**



**4**



**5**

## Connections

### For Better FM Reception **E**

#### For the European and U.K. model

**E-1** Connect the outdoor FM antenna to the FM 75 Ω terminal, using 75-ohm coaxial cable and IEC standard socket connector.

#### For the models for other countries

**E-2** Connect the outdoor FM antenna to the FM 75 Ω and *h* terminals, using 75-ohm coaxial cable.

### For Better AM Reception **F**

#### For the European and U.K. model

**F-1** Use the 6- to 15-meter (20- to 50-foot) insulated wire for connecting the terminal. Connect the *h* terminal to a good ground.

#### For the models for other countries

**F-2** Use the 6- to 15-meter (20- to 50-foot) insulated wire for connecting the terminal. Connect the *h* terminal to a good ground.

#### Important

When you use an external antenna, be sure to ground it against lightning. Never connect the ground wire to a gas pipe. Doing so is extremely dangerous.

### Power Connection

Connect the supplied AC power cord to AC IN and the other end to a wall outlet.

To attach the AM loop antenna to the main unit, in order to carry the unit. See the illustration **G**.

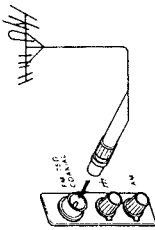

**E-1**

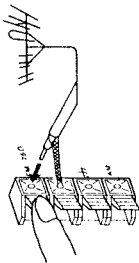

**E-2**

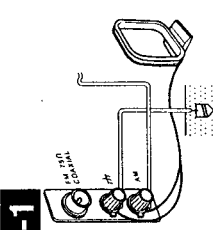

**F-1**

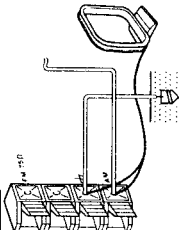

**F-2**

### G

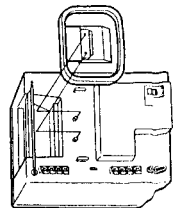

**G**



## CD Playing

### Locating a Particular Selection – Automatic Music Sensor (AMS)

The AMS locates the beginning of a selection.

To locate the beginning of the current or preceding selection **A** Press **[[<<<<]]** (or **[[>>>>]]** on the remote commander) as many times as required.

To locate the beginning of a succeeding selection **B** Press **[[>>>>]]** (or **[[<<<<]]** on the remote commander) as many times as required.

### Locating a Particular Point in a Selection

You can locate any particular point in the selection. This function works during play or pause. This operation is impossible with the remote commander.

To search while monitoring the sound

To move forward at high speed **B** Keep **[[>>>>]]** depressed and release it at the desired point.

To move backward at high speed **A** Keep **[[<<<<]]** depressed and release it at the desired point.

To search quickly

- 1 Press **[[H]]** to set the unit in pause mode.
- 2 Keep **[[<<<<]]** or **[[>>>>]]** depressed. The search speed increases, but there is no sound. Find the desired point by observing the display. Press **[[H]]** again at the desired point to play.

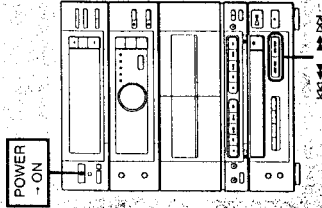

**A**



**B**

## CD Playing

### Playing the Entire Disc

- 1 Press **[[OPEN/CLOSE]]** to open the tray. Place a disc with the printed side up.
- 2 Press **[[H]]** (▶) on the remote commander. The tray closes and play starts.

The display shows **A** the current track number, **B** the current INDEX number (of the track), **C** elapsed playing time of the track and **D** track numbers.

### Caution on adjusting volume

Do not turn up the volume while listening to a portion with very low level inputs or no audio signals. If you do, the speakers may be damaged when a peak level portion is played.

To stop play

To stop for a moment during play Press **[[H]]** (||) on the remote commander. To resume play, press it again.

To stop play and open the tray

Press **[[OPEN/CLOSE]]**  
To play an 8 cm (3-inch) CD Place it on the inner circle of the tray. If the disc is provided with an adaptor, first remove it. Do not put a normal CD (12 cm/5-inch) on top of an 8 cm CD.

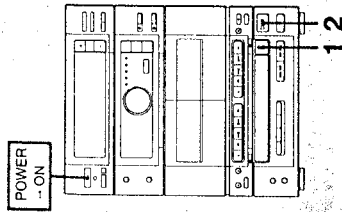

**1**



**2**

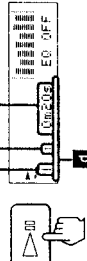

## Audio Adjustment

### Volume Adjustment **A**

Turn VOLUME clockwise to increase the sound level, or counterclockwise to decrease it. (Or press VOL + or - on the remote commander.)

### Sound Quality Adjustment

To reinforce bass **B** Press DBFB\*.

To activate surround effect for stereo sound **C** (Except for FH-B170K)

Press S-SUR\*\* during a stereo sound reproduction. This creates the atmosphere of a movie theater or concert hall. This function is not effective for a monaural sound.

(For FH-B170K) The KARAOKE PCN button is provided here. See page 114.

For personal listening **D**

Connect headphones to HEADPHONES. No sound comes from the speakers.

\*DBFB = Dynamic Bass Feedback  
\*\*S-SUR = Simulated Surround

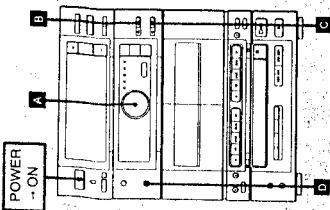

**A**

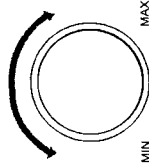

**B**



**C**



**D**

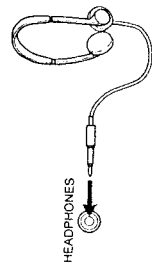

## CD Playing

### To locate a selection directly

Possible only with the remote commander

- 1 Set the TUNER/EO/CD selector to CD.
- 2 Press the numeric button for the selection.

If the selection number is greater than 12 Use the >12 and 1 to 10 buttons. "10". functions as the figure "0".  
 e.g. To play from selection number 22, press >12, 2, 2.  
 To play from selection number 30, press >12, 3, 10.

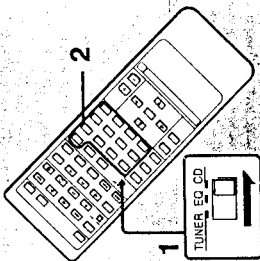

## CD Playing

### Information display

Possible only with the remote commander.

### To change the time display

Press TIME during play. The display changes to give you the following information.

- A Elapsed playing time of the current selection
- B Remaining time in a selection. If the current selection number is over 20, "m--s" is displayed.
- C Remaining time of the disc.

### To display the total playing time of the disc

Press TIME during stop. The following appears for about 4 seconds.

- A Total number of selections
- B Total playing time of the disc
- C Track numbers

This information appears also when you close the tray by pressing OPEN/CLOSE.

### Notes on handling discs

- A To keep the disc clean, handle the disc by its edge. Do not touch the surface.
- B Do not stick paper or tape onto the disc.
- C Do not expose the disc to direct sunlight or heat sources such as a hot air duct, nor leave it in a car parked in direct sunlight as there can be a considerable rise in the temperature.
- D After playing, store the disc in its case.

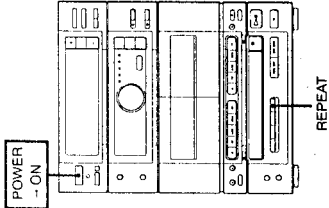

## CD Playing

### Playing Repeatedly -- Repeat Play

To repeat all the selections A Press REPEAT once during play so that "REPEAT" appears in the display.

### To repeat a single selection B

Press REPEAT twice while playing the desired selection so that "REPEAT 1" appears in the display. (Operable only in normal play and delete play mode)

To cancel repeat play Press REPEAT so that neither "REPEAT" nor "REPEAT 1" appears.

### Note

- Repeat play function works also during:
- A shuffle play
  - B delete play
  - C delete shuffle play
  - D program play.
- Multi-disc program play (see page 44) cannot be repeated.

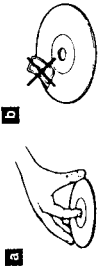

## CD Playing

### Information display

Possible only with the remote commander.

### To change the time display

Press TIME during play. The display changes to give you the following information.

- A Elapsed playing time of the current selection
- B Remaining time in a selection. If the current selection number is over 20, "m--s" is displayed.
- C Remaining time of the disc.

### To display the total playing time of the disc

Press TIME during stop. The following appears for about 4 seconds.

- A Total number of selections
- B Total playing time of the disc
- C Track numbers

This information appears also when you close the tray by pressing OPEN/CLOSE.

### Notes on handling discs

- A To keep the disc clean, handle the disc by its edge. Do not touch the surface.
- B Do not stick paper or tape onto the disc.
- C Do not expose the disc to direct sunlight or heat sources such as a hot air duct, nor leave it in a car parked in direct sunlight as there can be a considerable rise in the temperature.
- D After playing, store the disc in its case.

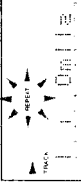
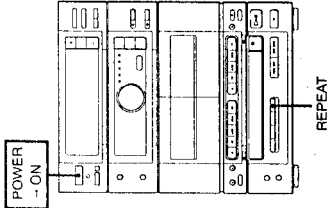

## CD Playing

### Playing in a Random Order - Shuffle Play

This operation is impossible with the remote commander. Shuffle play function plays all selections in a random order.

- 1 Press **SHUFFLE**. "SHUFFLE" appears in the display.
- 2 Press **▶**. "C" appears and then shuffle play starts.

To stop playing  
Press **■**.

#### To cancel shuffle play **A**

Press **CONTINUE**. "SHUFFLE" disappears (**B**), and play continues in normal play mode.

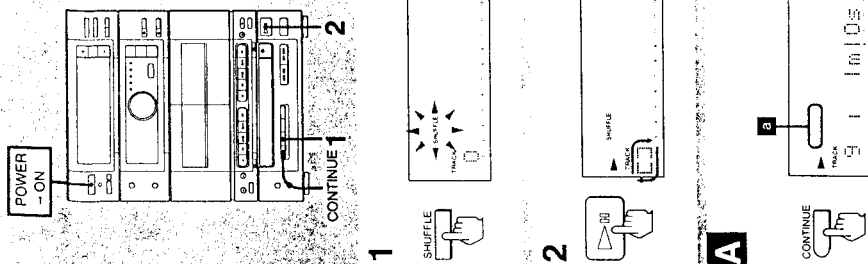

## CD Playing

### To play only the desired selections in a random order - Delete Shuffle Play

You can delete the undesired selections before or during shuffle play. This operation is possible only with the remote commander.

To delete a selection  
Press the numeric buttons (**B**) for the selection you want to delete. The number of the selection and "OFF" appears in the display.

To restore a selection which you have deleted  
Press the numeric buttons for that selection. The number of the selection and "ON" appears in the display.

To restore all selections which you have deleted  
Press **■** during stop.

### When you press REPEAT during shuffle play

After playing all the selections in a random order, shuffle play starts again in a different random order. During delete shuffle play, only the desired selections are played in a different random order.

### To check the remaining time

Press **TIME** once to see the remaining time of the selection being played; twice to see the total remaining time of the selections to be played; once more to return to the initial display.

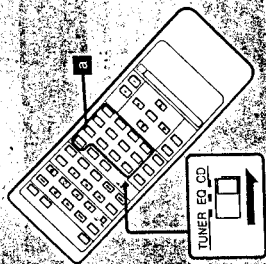

## CD Playing

### Playing Only the Desired Selections - Delete Play

You can delete the undesired selections before or during play.

To delete a selection before play

- 1 Press **SHUFFLE**. "SHUFFLE" appears in the display.
- 2 Press the numeric buttons for that selection. The number of the selection and "OFF" appears in the display.
- 3 Press **CONTINUE**. "SHUFFLE" disappears.
- 4 Press **▶** (or **▶** on the remote commander). Delete play starts.

To delete a selection during play

**A** Press **CLEAR** on the remote commander while that selection is being played. The number of the selection and "OFF" appears in the display and the next selection starts.

To restore all the selections which you have deleted  
Press **■** during stop.

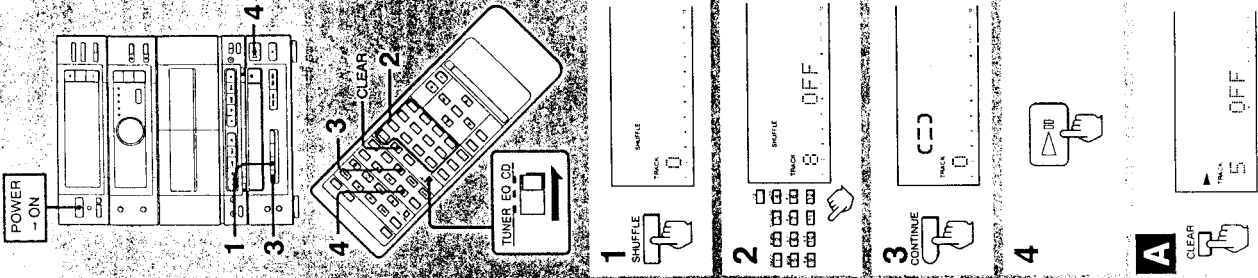

## CD Playing

### Playing in a Desired Order – Program Play

You can make a program for up to 24 selections in the order you want them to be played.

**Programming selections directly**  
Possible only with the remote commander.

- 1 Press **PROGRAM**.  
"PGM" appears in the display.
- 2 Press the numeric buttons for the desired selections in the desired order to be programmed.  
To choose a number greater than 12, see page 28.
- 3 Last programmed selection  
4 The order to be played  
5 Total playing time of selections  
6 Programmed selection numbers

3 Press ▶.

### To program selections while checking the total time

Use the [◀] and [▶] buttons (◀ and ▶ buttons on the remote commander) instead of the numeric buttons to choose the desired selections. Choose a selection with the [◀] and [▶] buttons, check the total time, and then press **PROGRAM** while the selection number is flashing.

### To program a pause

Press **H**.  
"P" appears and the total playing time is reset to 0.

### To stop play

Press **■**.  
To restart the same program play, press ▶.

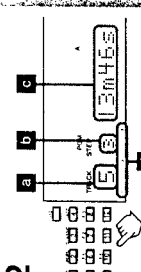
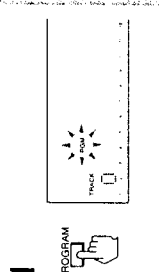
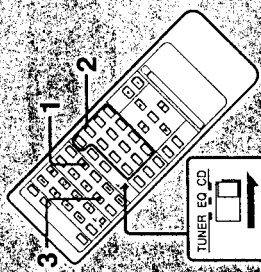

## CD Playing

### To cancel the program play

Press **CONTINUE**.  
The program is erased and the play continues in normal play mode.

### To press CHECK

Each time you press **CHECK**, the number of the selection and the order to be played appear in the display. After the last selection is displayed, "CHECK END" appears on the display.

### To add a selection to the end of the program

Press the numeric buttons.

### To erase a selection

- 1 Press **CHECK** so that the number of the selection you wish to erase appears.

### 2 Press CLEAR.

### To erase the entire program

Press **■** once during stop; twice during play.  
The program is also erased when you turn off the system.

### If "----s" is displayed

- You have programmed a selection the number of which is over 20.
- The total time has exceeded 100 minutes.

### To check the remaining time

Press **TIME** once to see the remaining time of the selection being played; twice to see the total remaining time of the whole program; once more to return to the initial display.

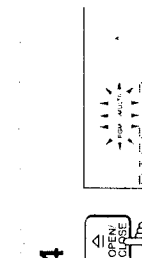
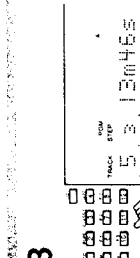
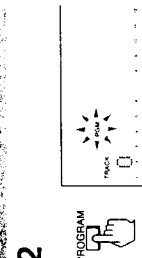
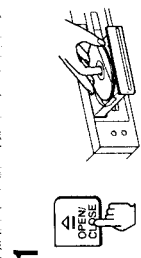
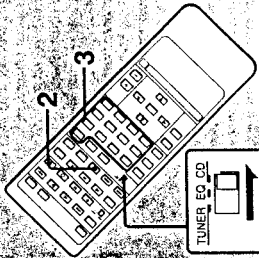
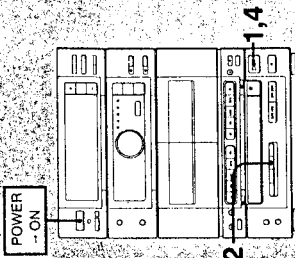

### Designating the Playing Order of Up to 6 Discs – Multi-disc Program

You can make a program by designating up to 24 selections from up to 6 discs in the order you want them to be played. At the same time, you can adjust the total playing time of the program. This function is convenient for editing tapes.

**To program selections directly**  
Possible only with the remote commander.

- 1 Insert the first disc.
- 2 Press **PROGRAM**.  
"PGM" appears in the display.
- 3 Press the numeric buttons for the desired selection in the desired order to be programmed.
- 4 Remove the disc and insert the second disc.  
"PGM (MULTI)" and "DISC 2" appear in the display.
- 5 Repeat steps 3 and 4 to program additional selections.  
Up to 24 selections from up to 6 discs can be programmed.  
The total playing time for all selections appears on the time display.

### To play the program

Insert the first disc and press **▶** (▶ on the remote commander).  
When "DISC 2" appears in the display, replace the first disc with the second disc and press **▶**. Continue replacing the discs until the last disc. When playback of the last disc is completed, "DISC END" appears in the display. The unit returns to the initial standby condition of program play from the first disc.

POWER  
-ON

2

1,4

3

1

2

3

4

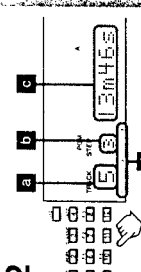
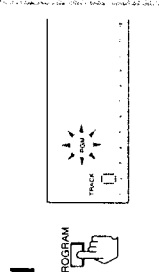
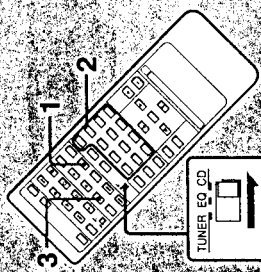
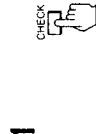
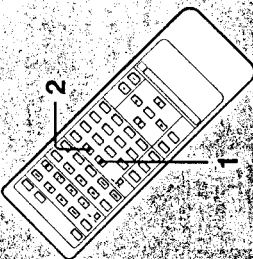

## Radio

### Tuning in Manually

- 1 Press **BAND** repeatedly until the desired band appears.
- 2 Press **TUNING -** or **+** repeatedly until the desired station appears.

**When an FM program is noisy or hard to receive**  
Press **STEREO/MONO** so that "MONO" appears in the display. There will be no stereo effect, but the reception will be improved.  
Press the button again to restore the stereo effect.

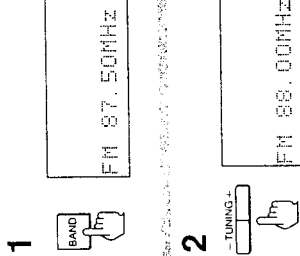
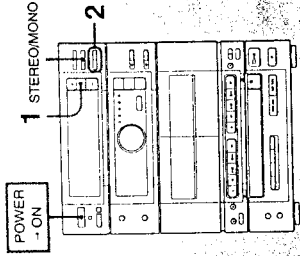

## Radio

The automatic tuning enables you to find a station when its signal is strong enough.  
When the signal is too weak, use the manual tuning. This operation is impossible with the remote commander.

### Tuning in Automatically

- 1 Press **BAND** repeatedly until the desired band appears.

As you press **BAND**, the band changes as follows:



- 2 Keep **TUNING -** or **+** depressed for more than 1 second. "AUTO" appears in the display and the unit tunes in a station automatically.
- 3 Repeat step 2 until the desired station appears.

### Indicator in the display

**TUNED:** Appears when a station of sufficient signal strength is tuned in.

**STEREO:** Appears when an FM stereo program of sufficient signal strength is received.

### Antenna adjustment

For FM reception, adjust the length and direction of the telescopic antenna (except for MHC-700).  
For AM (MW, LW and SW) reception, find the best location for the supplied AM loop antenna.

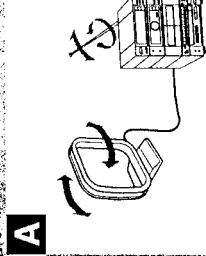
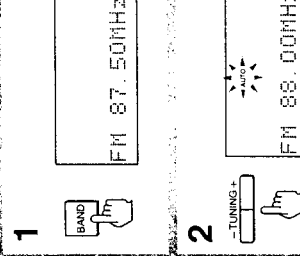
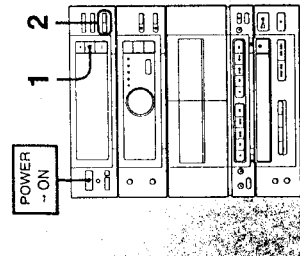

## CD Playing

**To stop playing**  
Press **■**.

**To cancel the program play**  
Press **CONTINUE**.

### To check the program

Press **CHECK**.  
Each time you press **CHECK**, the number of the disc and the selection appear. After the last selection is displayed, "CHECK END" appears in the display.

### To erase a selection from the end of the program

- 1 Insert the last disc.
- 2 Press **CLEAR**.  
Each time you press **CLEAR**, the selections are erased from the end of the program.  
If you insert a pause in your program, you cannot erase the selections programmed before the pause.

### To erase the entire program

Press **■** once during stop; twice during play.

### Notes on multi-disc program

- You cannot use the repeat play function.
- Do not insert a pause in your program when you want to use the **CD SYNC** button.

### If "m--s" is displayed

- You have programmed a selection number over 20.
- The total time has exceeded 100 minutes.

### To check the remaining time

Press **TIME** once to see the remaining time of the selection being played; twice to see the total remaining time of the programmed selections of the disc being played; once more to return to the initial display.

### To check the number of the disc inserted

Press **TIME** during stop.  
The number of the disc appears.

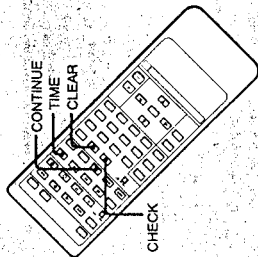

## Radio

### Storing Stations

You can store up to 20 FM stations and 10 MW stations and 10 LW (SW) stations (for the USA model), 20 FM stations and 10 AM stations in a desired sequence, so that you can tune in the stored station directly by entering the preset station number.

This operation is not possible with the remote commander.

- 1 Tune in the desired station.
- 2 Press MEMORY/NEXT. "MEMORY" and the preset station numbers appear in the display.
- 3 While "MEMORY" is on (for several seconds), press PRESET/TIMER - or + to select a desired preset number.
- 4 Press MEMORY/NEXT. "MEMORY" disappears, the preset number appears and the station is stored.
- 5 Repeat step 1 to 4 for each station to be stored.

If you cannot store a station successfully Press MEMORY/NEXT again so that "MEMORY" appears, and then proceed with steps 3 and 4 above.

Be sure to operate while "MEMORY" is on. (about 4 seconds.)

**When you have selected the wrong preset station number**  
Press MEMORY/NEXT again and then proceed with steps 3 and 4.

**To change the preset station**  
Store a desired station at the desired preset number by proceeding with the above steps. The station previously preset will be erased. Erasing only is not possible.

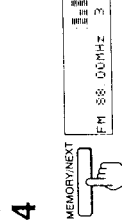
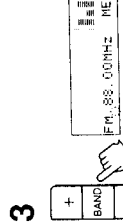
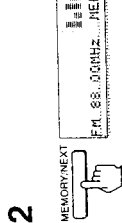
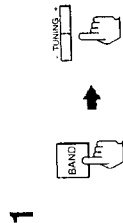
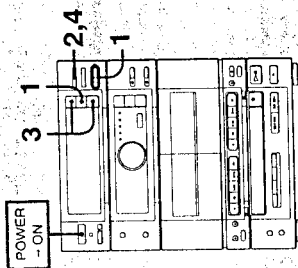

## Radio

### To Tune in a Preset Station

- 1 Press BAND to select a desired band.
  - 2 Press PRESET/TIMER - or + to select the desired preset number.
- To tune in a preset station directly **A**
- Possible only with the remote commander.

- 1 Set the TUNER/EQ/CD selector to TUNER.
- 2 Press BAND to select a desired band.
- 3 Press the numeric button to select a desired preset station number.

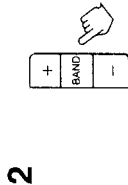
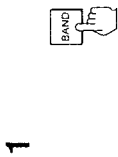
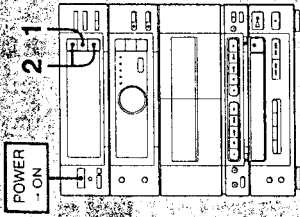

## Tape Playback

### Playback Operation

- 1 Insert a tape in deck A or B.
  - 2 Press ▷ (for front side playback) or ◀ (for reverse side playback).
- To stop playback Press ■.

To stop for a moment during play (Deck B only)  
Press PAUSE II.

### How to select the DIRECTION

#### MODE position

To playback one side, set it to **FR**.  
To playback both sides, set it to **DB**.  
To playback both decks in succession, set it to **RELAY**. See page 60.  
The DIRECTION MODE setting is effective for both decks.

## Playing back Automatically after Fast Winding - Auto Play

This function starts playback automatically from the beginning of the side after fast winding.

To start playback from the beginning of the front side  
Press ▷ while keeping ◀◀ pressed.

To start playback from the beginning of the reverse side  
Press ◀ while keeping ▶▶ pressed.

**When listening to the cassette recorded with the Dolby noise reduction system\***  
Set the DOLBY NR selector to ON. The writing is active for both decks. This system is provided with the DOLBY B NR system.

**What is the Dolby NR system?**  
Dolby NR (noise reduction) system reduces tape hiss noise in low-level high-frequency signals. The system boosts these signals during recording and lowers them during playback.

\* Dolby noise reduction manufactured under license from Dolby Laboratories Licensing Corporation.  
"DOLBY" and double-D symbol **DD** are trademarks of Dolby Laboratories Licensing Corporation.

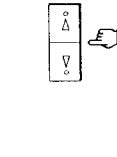
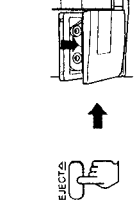
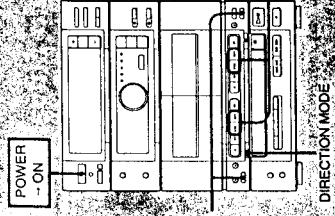

## Radio

### Storing Stations

You can store up to 20 FM stations and 10 MW stations and 10 LW (SW) stations (for the USA model), 20 FM stations and 10 AM stations in a desired sequence, so that you can tune in the stored station directly by entering the preset station number.

This operation is not possible with the remote commander.

- 1 Tune in the desired station.
- 2 Press MEMORY/NEXT. "MEMORY" and the preset station numbers appear in the display.
- 3 While "MEMORY" is on (for several seconds), press PRESET/TIMER - or + to select a desired preset number.
- 4 Press MEMORY/NEXT. "MEMORY" disappears, the preset number appears and the station is stored.
- 5 Repeat step 1 to 4 for each station to be stored.

If you cannot store a station successfully Press MEMORY/NEXT again so that "MEMORY" appears, and then proceed with steps 3 and 4 above.

Be sure to operate while "MEMORY" is on. (about 4 seconds.)

**When you have selected the wrong preset station number**  
Press MEMORY/NEXT again and then proceed with steps 3 and 4.

**To change the preset station**  
Store a desired station at the desired preset number by proceeding with the above steps. The station previously preset will be erased. Erasing only is not possible.

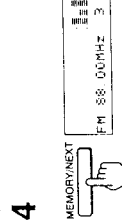
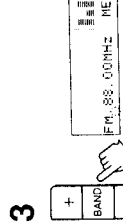
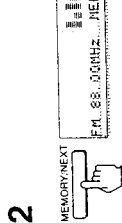
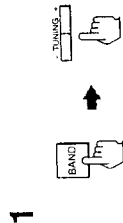
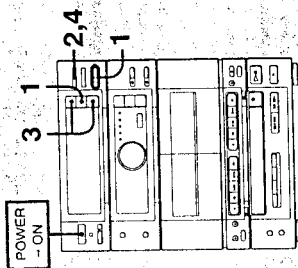

## Tape Playback

### Locating the Beginning of a Selection during Playback - Automatic Music Sensor (AMS)

The AMS locates the beginning of a selection by detecting the blank spaces between selections. To assure correct operation of the AMS, there must be a blank of 3 seconds or more between selections.

- 1 Press ◀ or ▶ to start playback.
- 2 Press ◀◀ or ▶▶ referring to the following table.

Side of the cassette being played (Indication on the display)	Desired selection	
	Next selection	Selection being played
Front side (▷)	▶▶	◀◀
Reverse side (◁)	◀◀	▶▶

### Notes on Cassettes

**To protect the recording** **A**  
Break off the tab on the left shoulder on the cassette side of which recording is to be protected.

**To re-record the cassette** **B**  
Cover each slot with plastic tape.

When using a type II (CrO<sub>2</sub>) cassette, be careful not to cover the detector slots **C** which are necessary for automatic tape type detection. **C**

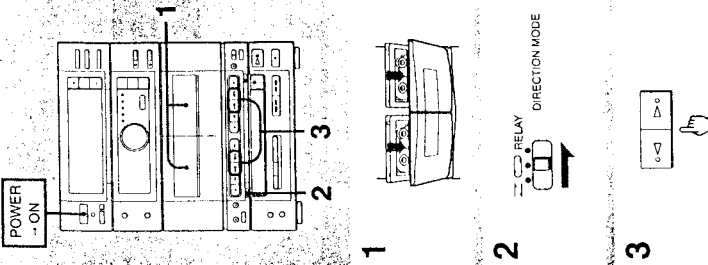

## Tape Playback

### Playing Both Decks in Succession - Relay Play

Relay play always follows the sequence below regardless of where playback starts. When playback of the reverse side of the tape in deck B is completed, the following sequence continues 4 more times.

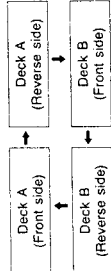

- 1 Insert recorded cassettes in both decks.
- 2 Set the DIRECTION MODE selector to RELAY.
- 3 Press ◁ or ▷ on either deck.

To stop relay play Press ■.

## Using the Graphic Equalizer

### Making Use of the Preset Equalizer Settings

When the system is shipped from the factory, 5 specially recommended settings of the graphic equalizer are stored. You can enjoy the effect of the equalizer by simply choosing from the preset settings according to the program source.

Press the desired preset equalizer setting button **A** on the remote commander by referring to the table below.

Display	Applications
1 DISCO	Gives a sound similar to a disco surrounded by hard walls.
2 POPS	Vocal sound is intensified.
3 CLASSIC	For orchestral music
4 JAZZ	For jazz
5 BGM	For background music

You can also select the preset equalizer setting by pressing PRESET on the front panel repeatedly.

When you do not want to apply the equalizer effect **A**  
Press EQ so that "EQ OFF" appears on the display.

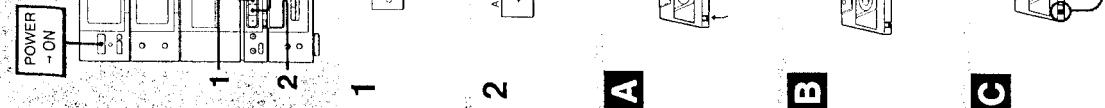
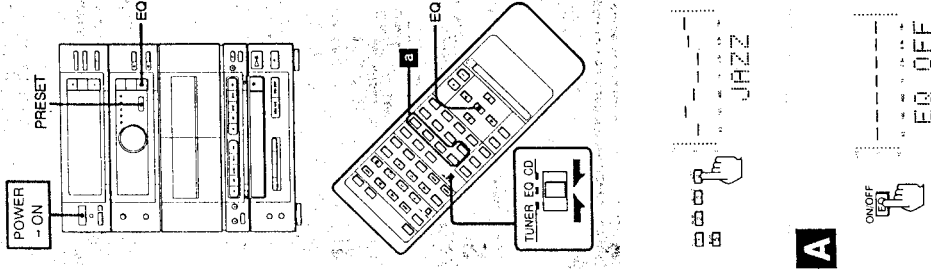

## Using the Graphic Equalizer

### Adjusting the Graphic Equalizer

This function allows you to adjust the sound by raising and lowering the level of specific frequency ranges. This operation is possible only with the remote commander.

- 1 Press EQ so that "EQ SET" appears in the display.
- 2 While the frequency range is flashing (for about 6 seconds), select the frequency range you wish to adjust using CURSOR CONTROL  $\blacktriangle$  or  $\blacktriangledown$ .
- 3 While the frequency range is flashing (for about 6 seconds), raise or lower the level of the frequency range with CURSOR CONTROL  $\blacktriangle$  or  $\blacktriangledown$ .

### Confirming the effect of the adjustment

Press EQ. You can compare the difference between the adjusted setting ("EQ ON" is displayed) and no equalizer effect ("EQ OFF" is displayed).

**The sound you adjust**  
You can record the sound you have adjusted with the graphic equalizer and the S-SUR button (not supplied for FH-R70K).

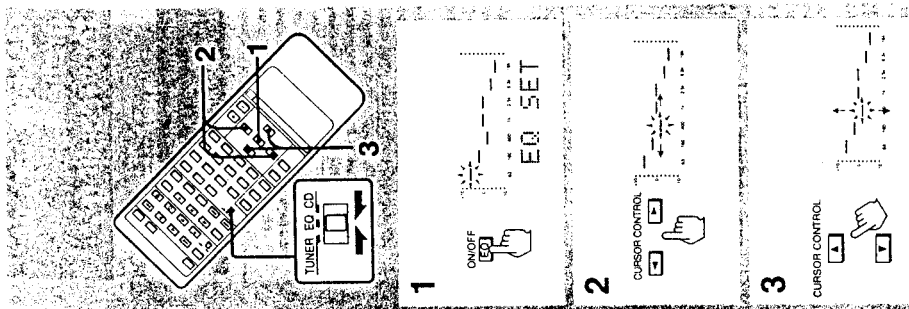

## Using the Graphic Equalizer

### Storing Your Individual Graphic Equalizer Settings - Personal File

By storing your individual graphic equalizer setting in the Personal File, you can easily call up the setting at any time. You can store up to 5 settings. This operation is possible only with the remote commander.

- 1 Adjust the sound with the graphic equalizer and the S-SUR button (except for FH-R170K). (See pages 64 and 22.)
- 2 Press MEMORY. "FILE 1" appears and flashes.
- 3 While "FILE 1" is flashing (for about 4 seconds), press CURSOR CONTROL  $\blacktriangle$  or  $\blacktriangleright$  to select a desired Personal File.
- 4 While the selected Personal File is flashing (for about 4 seconds), press MEMORY. The selected Personal File stops flashing. The equalizer setting is stored in the selected Personal File. The setting previously stored in the file is erased and replaced by the new setting.

### Calling up the setting from the Personal File

Press the desired Personal File (F-1 to F-5) button  $\square$  on the remote commander. You can also select the Personal File by pressing PRESET on the unit repeatedly.

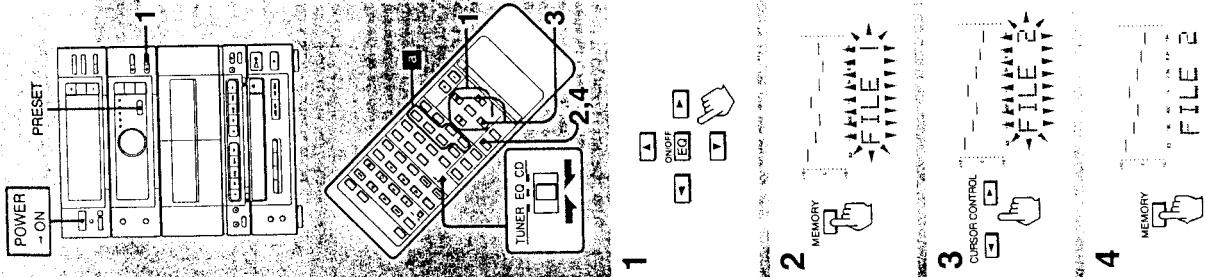

## Recording

### Recording Operation (Deck B)

Use TYPE I (normal) or TYPE II (C102) tapes for recording.

- 1 Insert a blank tape into deck B.
- 2 Select a program source and play it. To select the tuner, the CD player or the cassette deck, you do not have to press FUNCTION. You can select them directly by pressing the operation button BAND, PRESET/TIMER +/- or TUNING +/- to select the CD player, and  $\blacktriangleright$  or  $\blacktriangleleft$  to select the cassette deck.
- 3 Set the DIRECTION MODE selector. To record one side, set it to  $\blacktriangleright$ . To record both sides, set it to  $\blacktriangleleft$ .
- 4 Set to DOLBY NR switch to ON or OFF.
- 5 Press REC  $\blacksquare$ . The deck B enters the recording pause mode.
- 6 If the desired direction indicator is not illuminated, select the side to be recorded. Press  $\blacktriangleright$  (for front side recording) or  $\blacktriangleleft$  (for reverse side recording).
- 7 Press PAUSE II. The pause mode is released and recording starts.

To stop recording Press  $\blacksquare$ .

**Notes:**  
• Even if you set the DIRECTION MODE selector to  $\blacktriangleleft$ , recording stops at the end of the reverse side. To record on both sides, be sure to start with the front side.  
• The recording level is fixed and cannot be adjusted manually.

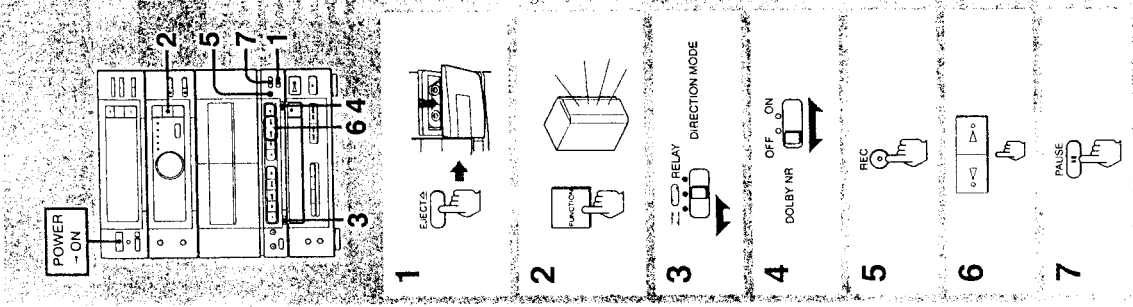

## Using the Graphic Equalizer

### Adjusting the Graphic Equalizer

This function allows you to adjust the sound by raising and lowering the level of specific frequency ranges. This operation is possible only with the remote commander.

- 1 Press EQ so that "EQ SET" appears in the display.
- 2 While the frequency range is flashing (for about 6 seconds), select the frequency range you wish to adjust using CURSOR CONTROL  $\blacktriangle$  or  $\blacktriangledown$ .
- 3 While the frequency range is flashing (for about 6 seconds), raise or lower the level of the frequency range with CURSOR CONTROL  $\blacktriangle$  or  $\blacktriangledown$ .

### Confirming the effect of the adjustment

Press EQ. You can compare the difference between the adjusted setting ("EQ ON" is displayed) and no equalizer effect ("EQ OFF" is displayed).

**The sound you adjust**  
You can record the sound you have adjusted with the graphic equalizer and the S-SUR button (not supplied for FH-R70K).

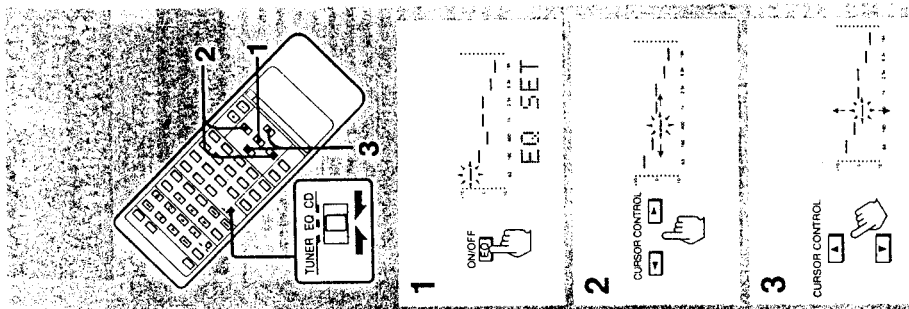



## Tape Dubbing (from deck A to B)

### Note on DIRECTION MODE setting

Position	Operation
	Dubbing stops at the end of the tape.
	When the tape in one deck comes to its end of the front side, it reverses immediately regardless of the tape position in the other deck.
RELAY	When the tape in one deck reaches its end of the front side, it stops until the other tape come to its end, and then both tape reverse together.

When dubbing starts from the reverse side in the RELAY mode  
At the end of the reverse side, dubbing stops automatically.

Is it necessary to set DOLBY NR? No. The tape in deck B is automatically recorded in the same state as the tape in deck A.

If the direction indicator on play button flashes 3 times and disappears  
The tab(s) of the cassette inserted into deck B has (have) been removed. Dubbing is not possible on that cassette. Cover the slot with plastic tape. (See page 58.)

## Tape Dubbing (from deck A to B)

### Dubbing the Whole Tape at High Speed

This operation is not possible with the remote commander.

- 1 Insert a recorded tape in deck A and a blank tape in deck B.
- 2 Set the DIRECTION MODE selector. To dub on one side: set it to or . To dub on both sides: set it to . (See "Note on DIRECTION MODE setting" page 74.)
- 3 Press HIGH SPEED. The deck B enters recording pause mode.
- 4 Choose the same direction on both decks by pressing or . To dub on one side, choose or . To dub on both sides, choose or .
- 5 Press PAUSE II. Dubbing starts. To stop dubbing Press .

POWER - ON

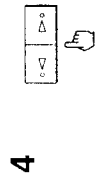
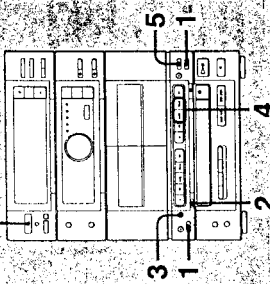

## Recording

### Inserting a Blank Space during Recording

This operation is possible only with the remote commander.

- 1 Press during recording at the position where the blank space is to be inserted. REC indicator flashes and the tape runs without recording. After 4 seconds, the unit enters recording pause mode.
- 2 Press at the position where you want to start recording again. Recording restarts. To make a blank of more than 4 seconds Press as long as needed. REC indicator flashes faster after 4 seconds have elapsed. The tape pauses when is released. To make a blank less than 4 seconds Press REC while REC indicator is flashing.

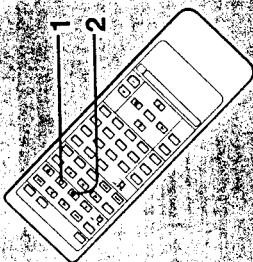

## Tape Dubbing (from deck A to B)

### Manual Dubbing

- 1 Press **FUNCTION** to select the cassette deck.
- 2 Insert a recorded tape in deck A and a blank tape in deck B.
- 3 Set the **DIRECTION MODE** selector. To dub on only one side, set it to . To dub on both sides, set it to .
- 4 Press **REC**. The deck B enters recording pause mode.
- 5 If the desired direction indicator is not illuminated, select the side to be recorded on the deck B. Press **▷** (for front side recording) or **◁** (for reverse side recording).
- 6 Press **▷** or **◁** on deck A. Playback starts.
- 7 Press **PAUSE II**. Normal speed dubbing starts.

To stop dubbing Press **■** on both decks.

Is it necessary to set **DOLBY NR?**  
No. The tape in deck B is automatically recording in the same state as the tape in deck A.

Is it possible to listen to program sources other than tape during dubbing?  
During high speed dubbing, yes. Any program source can be selected with the **FUNCTION** button.

During manual dubbing, no. The source changes to the function selected with the **FUNCTION** button and the tape playback cannot be dubbed.

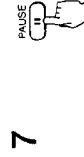
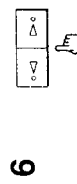
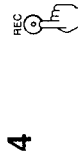
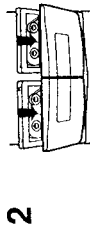
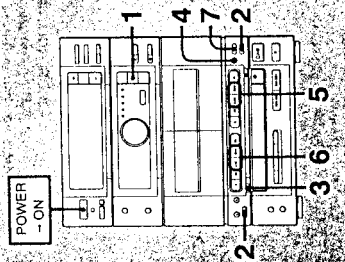

## CD Recording

### Fading Out at the Designated Time - Time Fade

You can have the disc play fade out at the end by designating the playing time so that the selection at the end of the tape fades out naturally without breaking abruptly in the middle. The player records the selections in the order they appear on the disc. 5 seconds before the designated time, the recording level falls gradually. At the designated time, the recording fades out and the CD player enters pause mode. This function works for both sides of the tape by designating the time once. This function works also during repeat, shuffle, and program play.

### Time Fade operation

This operation is not possible with the remote commander.

- 1 Insert a blank tape into deck B.
- 2 Place a disc with the label side up, and close the tray.
- 3 Press **EDIT/TIME FADE** three times and display "TIME FADE".
- 4 Designate the tape length.

When you use a 46", 54", 60", 74", or 90-minute cassette tape Press **←** and **→**. As you press these buttons, the minute display changes as shown in the illustration.

When you choose "HALF" The player fades out after playing just the half of the total playing time of the disc.

When you want to specify the recording time (of one side of the tape) more accurately Press the numeric buttons on the remote commander. (Make sure to set the **TUNER/EO/CD** selector to **CD**.)

Example: To specify the time of 11 minutes 30 seconds, press "1", "1", "3", and "0". ("10" functions as the figure "0".)

(to be continued)

## CD Recording

(continued)

- 5 Set the **DIRECTION MODE** selector. To record on one side, set it to . To record on both sides, set it to .
- 6 Press **REC**. The cassette deck enters recording pause mode.
- 7 If the desired direction indicator on play button is not illuminated, select the side to be recorded. Press **▷** (for front side recording) or **◁** (for reverse side recording)
- 8 Press **PAUSE II** of the cassette deck and **II** of the CD player. The pause mode is released, CD playing starts, and recording starts.

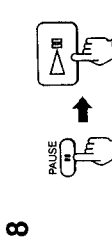
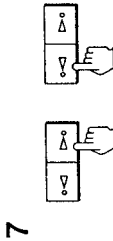
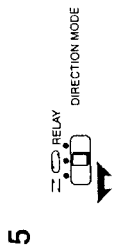

## CD Recording

**To stop recording**  
Press **■** of the cassette deck and the CD player.

**When playback ends**  
The CD player fades out and enters pause mode at the designated time. "TIME FADE B" appears in the display. The cassette deck reverses automatically if you set the DIRECTION MODE selector to .

If you want also to record on the reverse side of the cassette, press **PAH** after the tape reverses.

When playback of the reverse side ends and fades out, the player enters the pause mode and the Time Fade is canceled.

**To cancel the TIME FADE function**  
During stop, press **EDIT/TIME FADE** so that "TIME FADE" disappears.

**When the playback of the disc ends during Time Fade**  
The Time Fade function is still active. If you place another disc, the recording can be continued and will fade out when the total playing time of the discs reaches the designated time.

**About the remaining time during Time Fade**  
When you press **TIME** twice, the remaining time until the designated time is displayed.

If you press [**←** or **→**], Time Fade will be canceled.

## CD Recording

### Recording the Entire Program on a Disc - Fade Edit

CD program playback and tape recording start simultaneously due to the Synchronized Start function. The selection at the end of the tape does not break abruptly in the middle, but fades out automatically (Fade Edit Function).



#### How the Fade Edit function works

**A** The player records the selections in the order on the disc. If the tape ends in the middle of the selection, the player rewinds the tape to the beginning of that selection. Then the selection is re-recorded so that it fades out naturally at the end of the tape. If the recording is to be continued to the reverse side, the selection that faded out on the front side is recorded again from the beginning on the reverse side.

**Fade edit operation B**  
This operation is not possible with the remote commander.

- 1 Insert a blank tape into deck B.
- 2 Place a disc with the label side up, and close the tray.

**Note:**  
Make sure that the total number of selections and the total playing time appear in the display.

- 3 Set the DIRECTION MODE selector. To record on one side, set it to . To record on both sides, set it to .

(to be continued)

## CD Recording

(continued)

- 4 Press **CD SYNC**. The deck B enters recording pause mode.

5 If the desired direction indicator on play button is not illuminated, select the side to be recorded by pressing **◀** or **▶**. To record on the front side or on both sides, press **▶**. To record only on the reverse side, press **◀**.

- 6 Press **PAUSE II** on deck B. The recording starts. After about 10 seconds, the CD playback starts.

**To stop recording**  
Press **■** of the cassette deck and/or the CD player.

**Note:**  
When the tab on the cassette has been removed, the CD SYNC button does not operate.

**Is it possible to listen to program sources other than CD during CD recording?**  
No. If you select another function, the CD play stops and the selected program source will be recorded.

CD SYNC

4



5

PAUSE II

6

**A** Front side / Face avant / Cara frontal / 正面 / Voorkant  
Reverse side / Face arrière / Cara posterior / 反面 / Achterkant

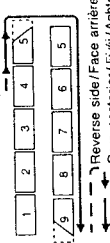

**B**

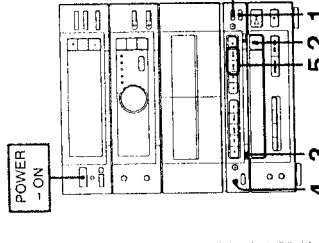

1

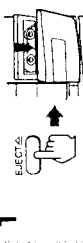

2

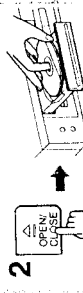

3



## CD Recording

### Editing the CD for Recording

The CD player automatically edits the selections on a disc according to the tape length. There are two ways of editing: Time Edit and Just Edit.

#### How the Time Edit function works

The CD player selects the selections so that the total recording time of the selections is within the tape length, and so that the order of the selections changes as little as possible. This function is convenient when you know the available recording length of the tape.

The player selects the selections from the first one in the disc, summing up each playing time. When the total playing time exceeds the specified tape length, the last selection is eliminated and replaced with another selection which is not longer than the remaining time. The eliminated selection is recorded on the reverse side. If you do not want to miss recording some specific selections, you can select them beforehand.

#### How the Just Edit function works

The CD player chooses the selections so that the total recording time of the selections is within the tape length, and so that you can record as many selections as possible by changing the order of the selections. This function is convenient when you want to record as many selections as possible.

The player selects the selections so that the total playing time best fits length of side A. Then the player selects from the remaining selections to record on side B. If you do not want to miss recording specific selections, you can select them beforehand.

**Note:**  
You can edit only the selections from track numbers 1 to 20 in the disc using the Time Edit and Just Edit.

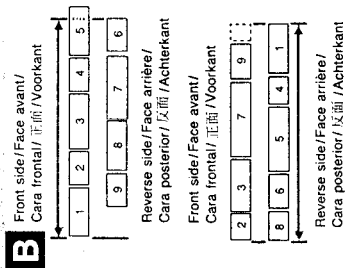
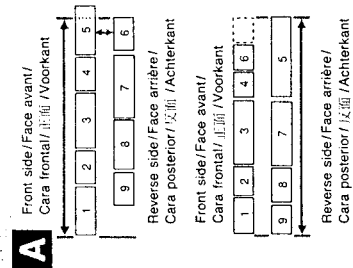

## CD Recording

**Time Edit and Just Edit operations**  
This operation is not possible with the remote commander.

- 1 Insert a blank tape into deck B.
- 2 Place a disc with the label side up, and close the tray.
- 3 Press **EDIT** (Time Fade and display "EDIT" (Time Edit) or "JUST EDIT"). To choose Time Edit, press **EDIT/TIME FADE** once. To choose Just Edit, press **EDIT/TIME FADE** twice.

#### 4 Designate the tape length.

When you use a 46-, 54-, 60-, 74-, or 90-minute cassette tape Press **[<->]** and **[>->]**. As you press these buttons, the minute display changes as shown in the illustration.

#### When you choose "HALF" during Time Edit

The player divides the selections in the disc between side A and side B without changing their order and records them so that no selection is left out.

#### When you choose "HALF" during Just Edit

The player programs the selections by changing their order so that the recording time of one side of the tape is half the total playing time of the disc. However, the program of side A may be a little longer than that of side B because the player distributes all the selections.

**When you want to specify the recording time (of one side of the tape) more accurately**  
Press the numeric buttons on the remote commander. (Make sure to set the TUNER/EO/CD selector to CD)

**Example:** To specify the time of 11 minutes 30 seconds, press "1", "1", "3", and "10".  
("10" functions as the figure "0".)

(to be continued)

## CD Recording

(continued)

- 5 Press **EDIT/TIME FADE**. The selections to be recorded on one side are determined automatically. Then the display shows **a** the last selection to be recorded, **b** the programmed order, **c** total playing time, and **d** the selections to be recorded.

#### For recording on both sides

Press **EDIT/TIME FADE** again. The selections to be recorded on the other side are determined.

**To add selections (Link function)**  
If there is remaining time even after programming all the selections on the disc, the LINK indication and the selection numbers that can be recorded within the remaining time flash in the display window. You can choose from these selections to add to the program. When you want to record the selections of another disc, replace the disc. The selection numbers that can be recorded flash in the same way.

- 6 Set the **DIRECTION MODE selector**. To record on one side, set it to **→**. To record on both sides, set it to **↔**.
- 7 Press **CD SYNC**. The deck B enters recording pause mode.

(to be continued)

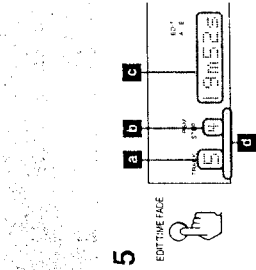

#### 6

Set the **DIRECTION MODE selector**. To record on one side, set it to **→**. To record on both sides, set it to **↔**.



#### 7

Press **CD SYNC**. The deck B enters recording pause mode.

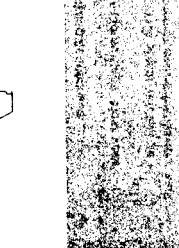

## CD Recording

(continued)

- 8** If the desired direction indicator on play button is not illuminated, select the side to be recorded by pressing  $\blacktriangleright$  or  $\blacktriangleleft$ .  
To record on the front side or on both sides, press  $\blacktriangleright$ .  
To record only on the reverse side, press  $\blacktriangleleft$ .

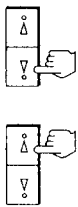

**9**

- 9** Press PAUSE II button. The recording starts. After about 10 seconds, the CD playback starts.



**To stop recording**  
Press ■ on the cassette deck or the CD player.

### Notes:

- Do not press any other buttons than those mentioned in the procedure during Time Edit or Just Edit.
- When the tab on the cassette has been removed, the CD SYNC button does not operate.

### To select the desired selections preferentially

You can place priority on some selections to be recorded by pre-selecting them first using the program function of the CD player (see page 40).

### Note:

The Time Edit and Just Edit functions do not work when you program more than 20 selections on one disc.

### To check the program

Press CHECK. In the display window, "A" appears while checking the program for side A, and "B" appears while checking the program for side B.

### If it takes time for programming during Just Edit

For some discs with many selections, it may take a while for programming. In that case, press ■ if you want to cancel the Just Edit operation.

### To use the CD synchronized recording function with more than one disc

Use the multi-disc program function (page 44). Press the CD SYNC button each time you change the disc.

## CD Recording

### Programming the Selections while Checking the Total Playing Time - Program Edit

You can adjust the total playing time to the tape length.

- 1** Press PROGRAM. "PGM" appears in the display.  
**2** Choose a desired selection to be programmed with  $\blacktriangleleft$  or  $\blacktriangleright$  and check the time.

If satisfactory, go to the next step. If not, repeat step 2 and choose another selection.

- 3** Press PROGRAM. The selected selection number is memorized.

- 4** Repeat steps 2 to 3 to program desired selections for side A. (Be sure that "A" is lit in the display.)

- 5** Press II (for the CD player) on the remote commander. "P" appears in the display and the total playing time is reset to 0. "B" lights up.

(to be continued)

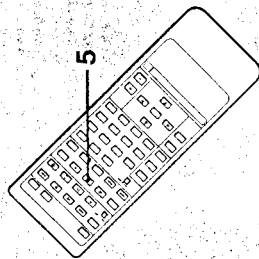
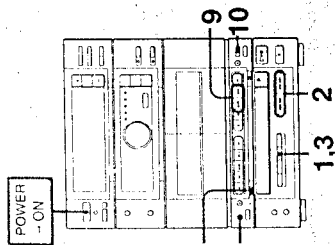

**1**



**2**



**3**



**5**



## CD Recording

(continued)

- 6** Repeat steps 2 to 3 to program the desired selections for side B.

- 7** Set the DIRECTION MODE selector. To record on one side, set it to  $\blacktriangleright$ . To record on both sides, set it to  $\blacktriangleleft$ .

- 8** Press CD SYNC. The deck B enters recording pause mode.

- 9** Select the side to be recorded by pressing  $\blacktriangleleft$  or  $\blacktriangleright$ . To record on the front side or on both sides, press  $\blacktriangleright$ . To record only on the reverse side, press  $\blacktriangleleft$ .

- 10** Press PAUSE II of the cassette deck. The recording starts. About 10 seconds, the CD playback starts.

**To stop recording**  
Press ■ on the cassette deck or the CD player.

### Note:

Be sure to program the selections so that the total playing time of each side does not exceed the tape length of one side.

**7**

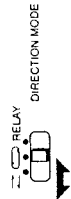

**8**



**9**



**10**



## Timer-Activated Operation

### Setting the Wake Up Timer

The power can be turned on automatically so that you can wake up with music. One hour later, the power is turned off automatically. The preset timer-on time remain until you reset it or you disconnect the power cord.

**Before setting the timer**  
Make sure the clock is set correctly. (See page 20)

**1 Press TIMER for more than 2 seconds.**  
"TIMER" and "ON" appear and the hour digits flash in the display.

**2 Set the hour and minute of the timer-on time by pressing PRESET/TIMER or -- and MEMORY/NEXT.**  
The program source flashes.

**3 Select the program source by pressing PRESET/TIMER + or --.**  
As you press the button (+ or --), the source changes as follows:

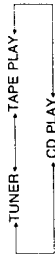

**To listen to the radio:**

- 1) Press MEMORY/NEXT. The frequency display appears.
- 2) Press BAND to select the desired band.
- 3) Press PRESET/TIMER + or -- to select the desired selection.

**To listen to a tape:** go to step 6.

**To listen to a compact disc:**

- 1) Press MEMORY/NEXT. The selection number display appears.
- 2) Press PRESET/TIMER + or -- to select the desired selection. (only from track numbers 1 to 20)

(to be continued)

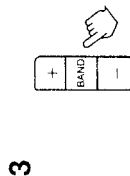
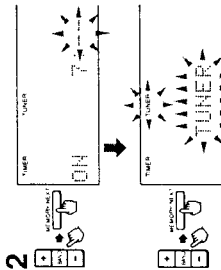
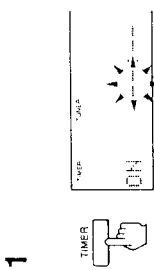
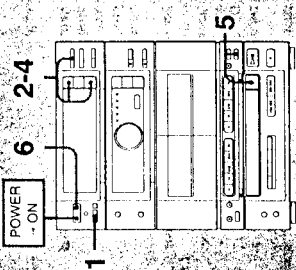

## Timer-Activated Operation

(continued)

**4 Press MEMORY/NEXT.**  
The preset items appear sequentially.

**5 Prepare the program source by inserting a disc or a tape.**

- For listening to the radio: You do not have to tune in the station.
- For listening to a tape: Insert the tape in deck B.

**6 Press POWER to turn off the system.**  
At the timer-on time, the system turns on automatically.

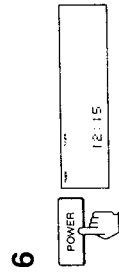
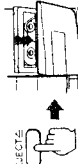
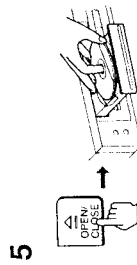

## Timer-Activated Operation

### Setting the Recording Timer

The power can be turned on and off automatically so that you can record a radio program while you are out. The preset timer-on and -off times function only once.

**Before setting the timer**

- Make sure the clock is set correctly. (See page 20).
- Be sure to insert a cassette tape that is long enough.

**1 Press TIMER REC for more than 2 seconds.**  
"TIMER REC" and "ON" appear and the hour digits flash on the display window.

**2 Set the hour and minute of the timer-on time by pressing PRESET/TIMER + or --, and MEMORY/NEXT.**  
"OFF" appears and the hour digits flash again.

**3 Set the hour and minute of the timer-off time by pressing PRESET/TIMER + or --, and MEMORY/NEXT.**  
The frequency display flashes.

(to be continued)

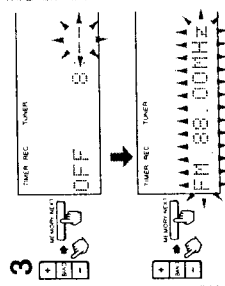
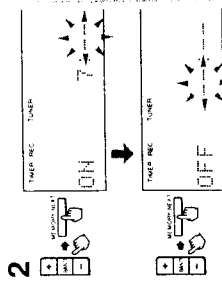
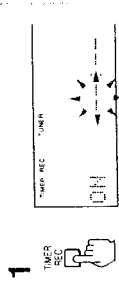
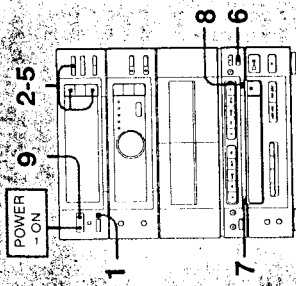

## Timer-Activated Operation

- (continued)
- Press BAND and PRESET/TIMER + or - to tune in the desired preset station.
  - Press MEMORY/NEXT. The preset items appear sequentially.
  - Insert a cassette in deck B.
  - Set the DIRECTION MODE selector. To record on one side, set it to . To record on both sides, set it to .
  - Set the DOLBY NR to ON or OFF.
  - Press POWER to turn off the system. Make sure that "TIMER REC" and "TUNER" are displayed. At the timer on time, the system turns on automatically.

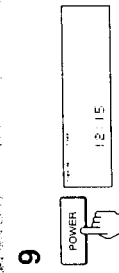
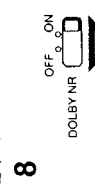
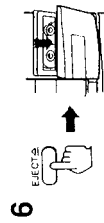
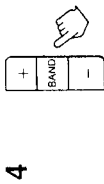

## Timer-Activated Operation

- To change the time and program Press TIMER (or TIMER REC for timer recording) for more than 2 seconds.
  - Press MEMORY/NEXT until the item to be changed flashes.
  - Press PRESET/TIMER + or - to change that item.
  - Press MEMORY/NEXT until the preset items appear sequentially.
- When you do not want to use the timer program Press TIMER (or TIMER REC) so that "TIMER" (or "TIMER REC") disappears.
- When the power is already on at the preset time The program source automatically changes to the preset one, even if you are playing another program source. However, when you have preset the recording timer, recording will not start even though the station is tuned in. Be sure to turn off the power before the preset time for timer recording.

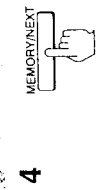
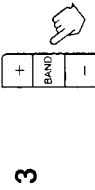
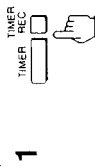
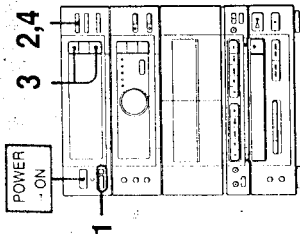

## Sleep Timer Operation

By setting the sleep timer, the system power can be turned off after the preset duration (up to 90 minutes). This operation is possible only with the remote commander.

- Play a desired program source.
- Press SLEEP to select the desired duration in minute. As you press SLEEP, the indication changes as follows:



To turn off the system before the timer is turned off by the sleep timer Press POWER.

To check the remaining time before the sleep timer turns off the system Press SLEEP once, and the remaining time appears. The display returns to the previous indication automatically after several seconds.

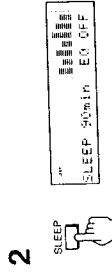
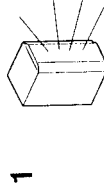
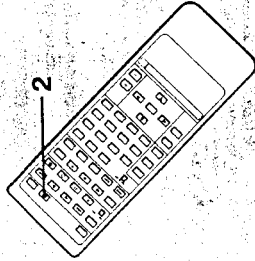

## Microphone Mixing

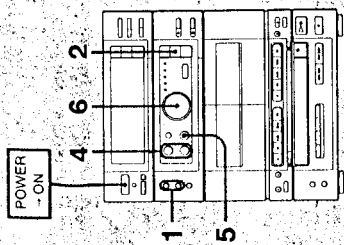

- MIC 1 LEVEL** knob (MIN to MAX)
- MIC 2 LEVEL** knob (MIN to MAX)
- MIX MIC** jack
- FUNCTION** button
- ECHO LEVEL** knob (MIN to MAX)
- Speaker** diagram with MIN and MAX volume indicators

### Mixing Operation

- Turn down the **MIC 1** and **2 LEVEL** controls completely and connect microphones to the **MIX MIC 1** and **MIC 2** jacks. (only for FH-B170K) Connect a microphone to the **MIX MIC** jack. (for other models)
- Press **FUNCTION** to select program source and play it.
- Sing or speak into the microphone(s).
- (only for FH-B170K) Adjust the microphone volume level with the **MIC 1** and/or **2 LEVEL** control(s).
- (only for FH-B170K) Adjust the **ECHO LEVEL** control.
- Adjust the **VOLUME** control.

**When the mixing is over**  
Be sure to disconnect the microphone(s).

**Recording the sound mixed with a source**

- Mix the sound as described above.
- Insert a tape in deck B.
- Start recording.

**Recording from a microphone only**

- Press **FUNCTION** to select the CD player. If a CD is being played, press **■** to stop playing.
- Start recording.

**When only one microphone is used (for FH-B170K)**  
Connect it to the **MIX MIC 1** jack and turn down the **MIC 2 LEVEL** completely.

**To stop howling (acoustic feedback)**  
Placing the microphone too close to the speakers may cause howling. Move the microphone away from the speakers or change the direction it faces.

## Singing along (FH-B170K only)

### Reducing the Vocals of a disc/tape - Vocal Reduction

You can sing with any desired stereo source by pressing the **KARAOKE PON** button which minimizes the singer's voice.

**To reduce the vocal**  
Press the **KARAOKE PON** button so that the indicator turns on.

**To cancel the vocal reduction**  
Press the button again so that the indicator turns off.

**Notes on the vocal reduction**

- Utilize stereo recorded sources. Not only would the singer's voice be reduced, but instrumental sounds may also be reduced with monaural recorded sources.
- The singer's voice may not be reduced completely for the following.
  - Stereo recorded sources containing only few instruments
  - Duet
- Sources with strong echoes and chorus
- Sources with singer's voice deviating from the center
- Sources with singer's voice with extreme soprano or tenor
- When vocal reduction is used, the play sound will be monaural.

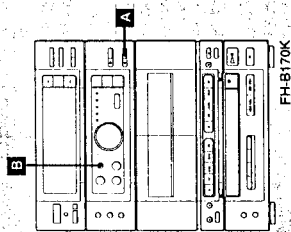

### Singing Along with Multiplex Tapes

This feature can be made use of when you enjoy singing along with microphones connected to the unit, while playing back a multiplex tape.

- To enjoy singing along, press **MPX** (multiplex) so that the indicator is turned on. You can hear only instrumental music and your voice through the microphone without recorded voice.
- To hear both instrumental music and recorded voice, press **MPX** again so that the indicator is turned off.

**What is a multiplex tape?**  
Instrumental music and vocals were recorded respectively on the left channel and on the right channel. Therefore, when playing back a tape instrumental music comes from the left speaker and vocals come from the right speaker separately.

## Maintenance

### Cleaning the Heads and the Tape Paths A

Clean after every 10 hours of operation and before recording for optimum record/playback quality.

- Press **EJECT** to open the cassette holders.
- Slightly moisten the tip of a cotton swab with cleaning fluid or alcohol.
- Wipe the parts shown in the illustration:
  - Capsian
  - Erase head
  - Record/playback head
  - Pinch roller

Do not insert a cassette until cleaned areas are completely dry.

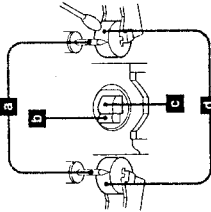

### Demagnetizing the Heads

After 20 to 30 hours of use, it is necessary to remove residual magnetism built up on the head using any commercially available demagnetizer. For demagnetizing procedure, refer to the instruction manual of the demagnetizer.

### Cleaning Discs B

When a disc becomes dirty, clean it with a cleaning cloth. Wipe the disc from the center out.  
Do not use solvents such as benzine, thinner, commercially available cleaners, or anti-static spray intended for analog discs.

### Cleaning the Cabinet

Use a soft cloth slightly moistened with mild detergent solution.



## SECTION 3 DISASSEMBLY

NOTE: Follow the disassembly procedure in the numerical order given.

### 3-1. CASE

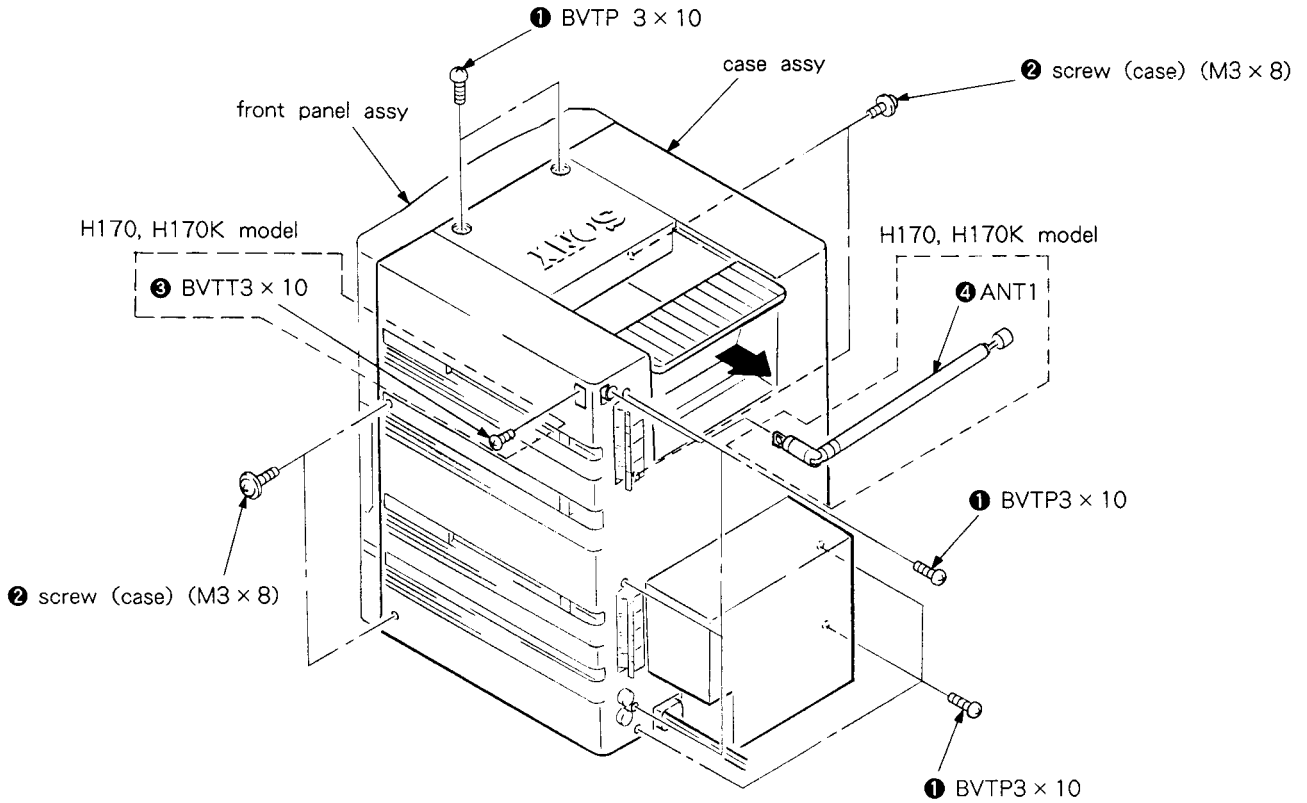

### 3-2. POWER BLOCK

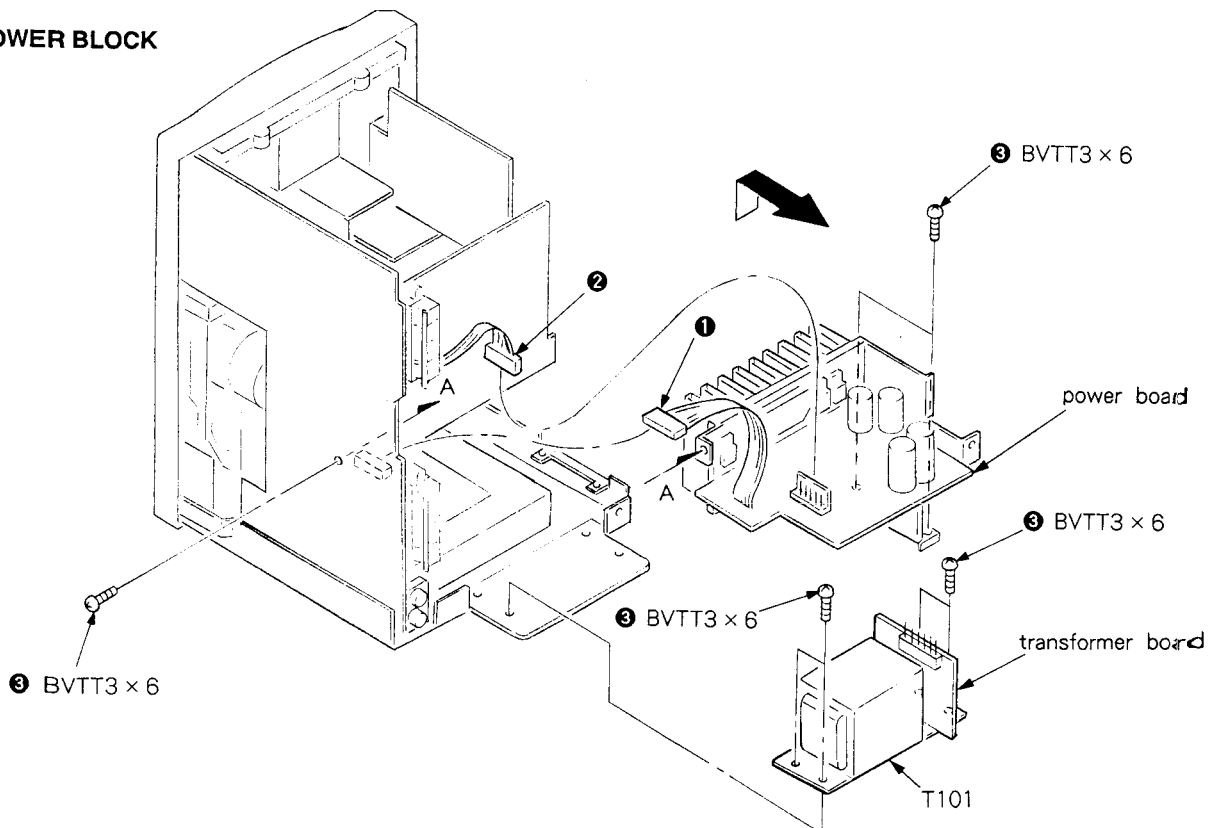

3-3. MAIN BOARD

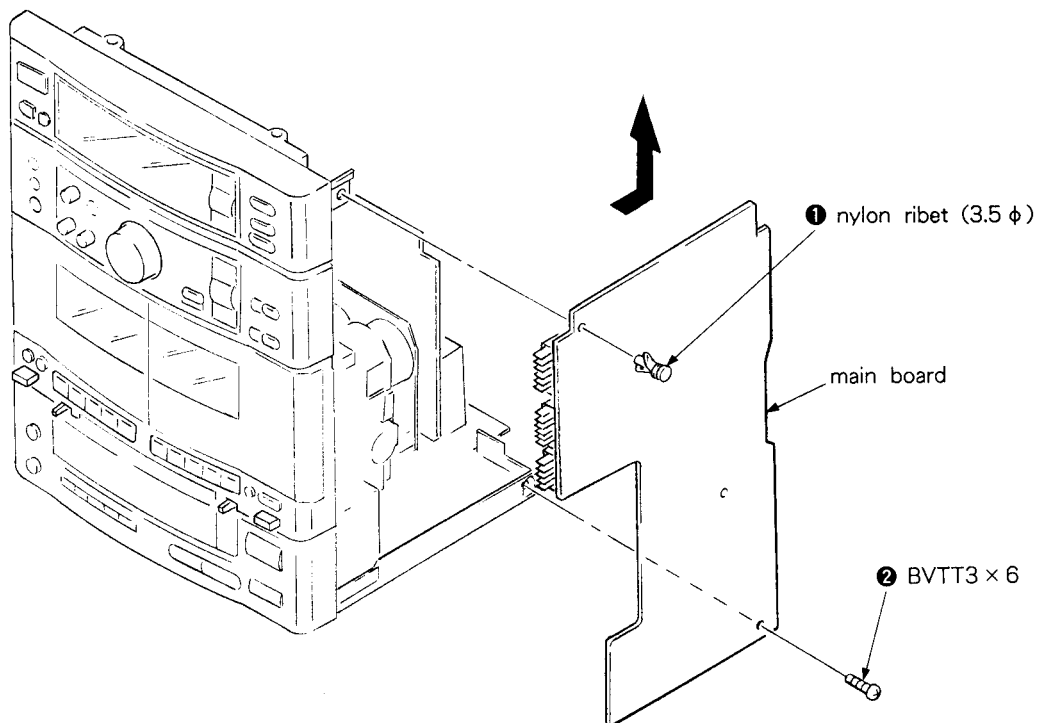

3-4. CD MECHANISM BLOCK

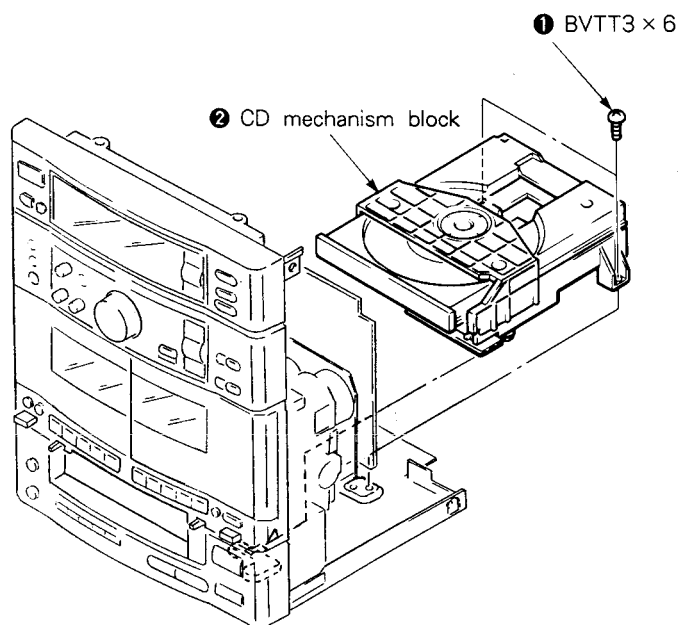

3-5. TC MECHANISM BLOCK

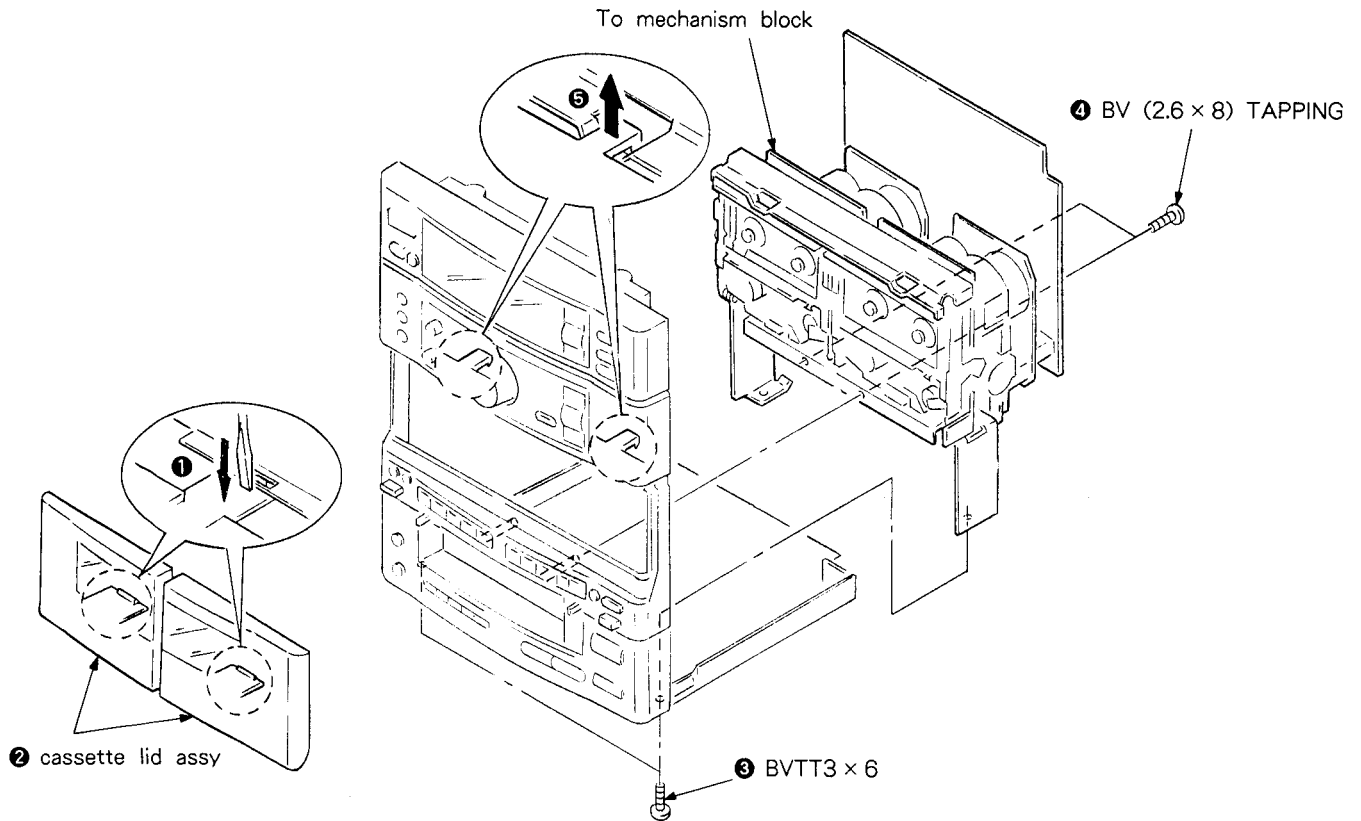

3-6. VOLUME/MIC HP/DISPLAY/SW BOARD

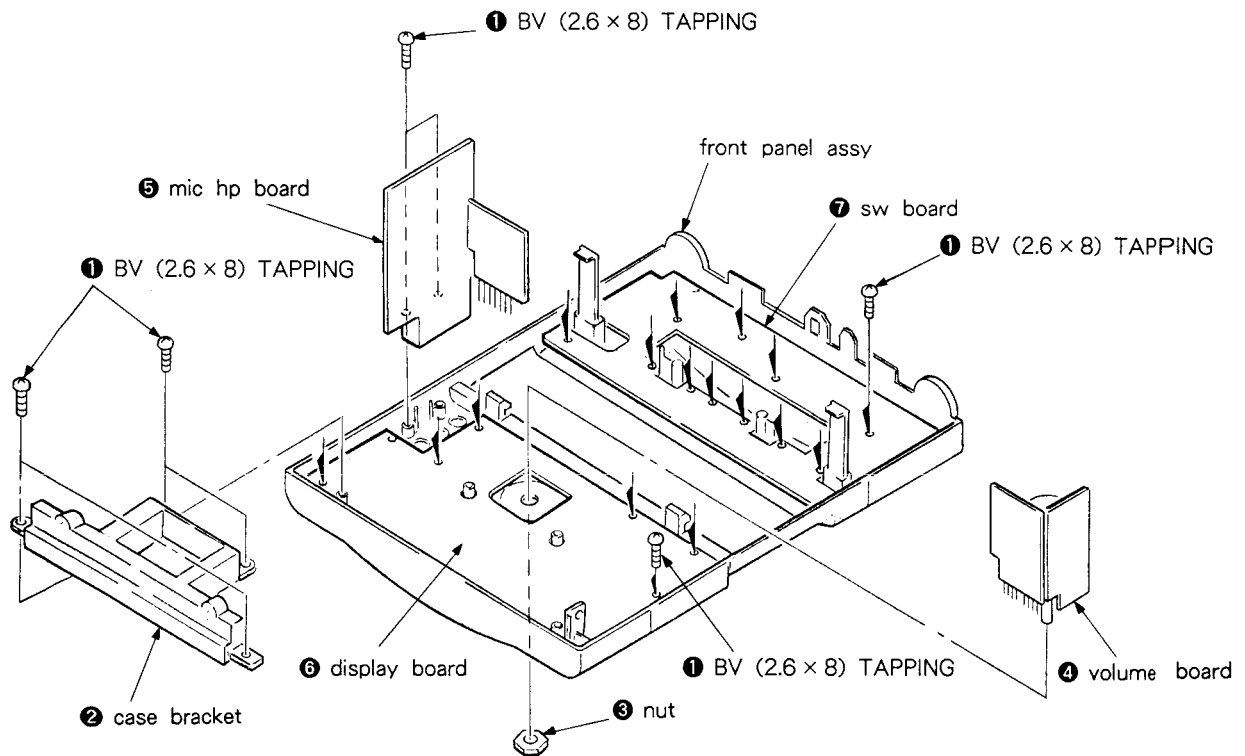

## SECTION 4 MECHANICAL ADJUSTMENTS

### PRECAUTION

1. Clean the following parts with a denatured alcohol-moistened swab:
 

record/playback head	pinch roller
erase head	rubber belt
capstan	idler
2. Demagnetize the record/playback head with a head demagnetizer.  
(Head demagnetizer do not approach for the erase head.)
3. Do not use a magnetized screwdriver for the adjustment.
4. After the adjustments, apply suitable locking compound to the parts adjusted.
5. The adjustment should be performed with the rated power supply voltage unless otherwise noted.

### • Torque Measurement

Torque	Torque meter	Meter reading
Forward	CQ-102C	35 to 60g • cm (0.49 to 0.83oz • inch)
Forward back tension	CQ-102C	2 to 6g • cm (0.028 to 0.08oz • inch)
Reverse	CQ-102RB	35 to 60g • cm (0.49 to 0.83oz • inch)
Reverse back tension	CQ-102RB	2 to 6g • cm (0.028 to 0.08oz • inch)
FF/REW	CQ-201B	70 to 110g • cm (0.98 to 1.52oz • inch)

### • Timer Test Mode

When BAND, SHIFT and PRESET/TIMER+ buttons are pressed at the same time the following time test operation is performed. After the operation, it becomes in the system reset mode. Take care that the frequency preset to the tuner is initialized.

- 1) POWER OFF
- 2) Timer set
 

Clock	AM10: 23
Timer ON	AM10: 24
Timer OFF	AM10: 31
Function	TUNER
- 3) FL tube display (FL1100)
 

All light

↓ for 2 seconds

"AM 10: 23"

↓ for 0.5 second

"AM 10: 24"

↓ for 0.5 second

"TUNER" ← POWER ON

↓ for 2 seconds

Last channel

↓ for 1 second

"AM 00: 00" flashing ← POWER ON
- 4) Finish

## SECTION 5 ELECTRICAL ADJUSTMENTS

### DECK SECTION

1. The adjustment should be performed in the publication.  
(Be sure to make playback adjustment at first.)
2. The adjustment and measurement should be performed for both L-CH and R-CH.
  - Switch position  
DOLBY NR switch : OFF

### • Test Tape

Tape	Contents	Use
P-4-A100	10kHz, -10dB	Head Azimuth Adjustment
P-4-L300	315Hz, 0dB	Level Adjustment
WS-48B	3kHz, 0dB	Tape Speed Adjustment

### Record/Playback Head Azimuth Adjustment

DECK A DECK B

#### Procedure :

1. Forward Playback Mode  
Reverse Playback Mode

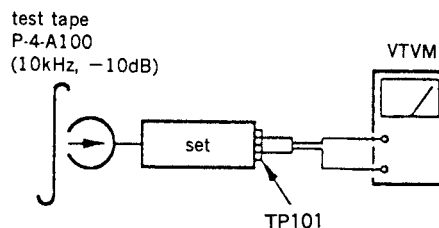

- Turn the adjustment screw for the maximum output levels. If these levels do not match, turn the adjustment screw until both of output levels match together within 1dB.

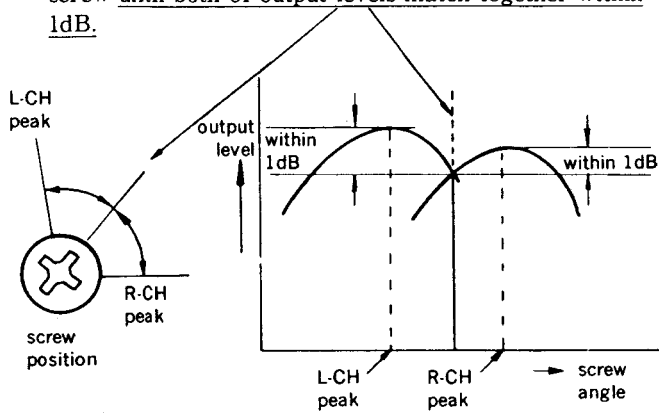

3. Playback Mode

test tape  
P-4-A100  
(10kHz, -10dB)

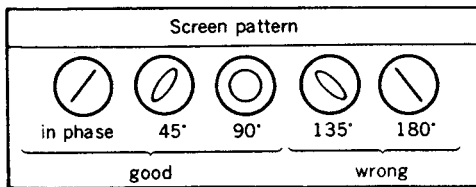
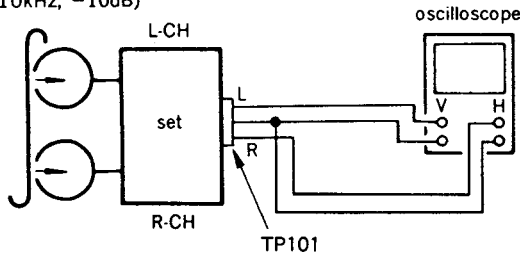

- Change the review playback mode and repeat the steps 1 to 3.
- After the adjustment, lock the adjustment screw with suitable locking compound.

Adjustment Location :

—record/playback head (deck A and B)

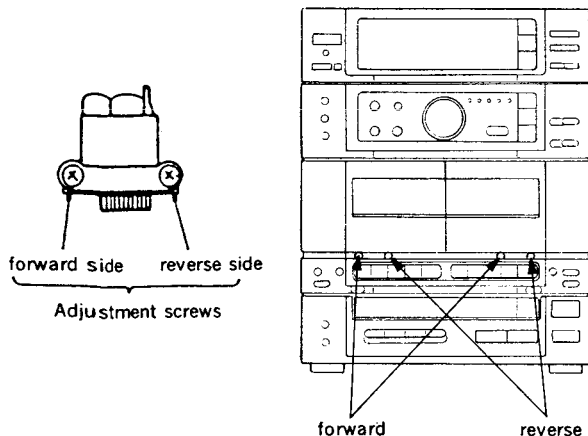

Tape Speed Adjustment **DECK A** **DECK B**

Procedure :

- Perform high speed adjustment before normal speed adjustment.

Mode : playback

test tape  
WS-48B  
(3kHz, 0dB)

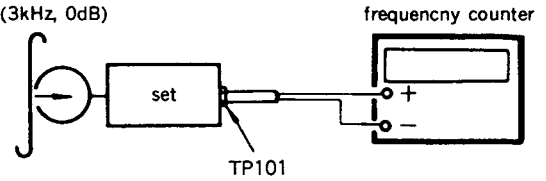

Speed	Deck	Adjustment	Frequency counter
※ High	A	RV72A	5,970 to 6.030Hz
	B	RV72B	
Normal	A	RV71A	2,985 to 3,015Hz
	B	RV71B	

※ Continue to press HIGH SPEED DUBBING switch (S1523) in playback mode : High speed playback.

Frequency difference between the beginning and the end of the tape should be within ±1.5%.

Adjustment Location: MD-A and MD-B boards.

Playback Level Adjustment **DECK A** **DECK B**

Procedure :

Mode : playback

test tape  
P-4-L300  
(315Hz, 0dB)

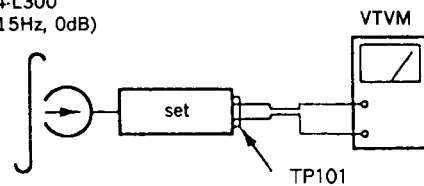

Deck A is RV11A (L-CH) and RV21A (R-CH), deck B is RV11B (L-CH) and RV21B (R-CH) so that adjustment within adjustment level as follows.

Adjustment Level :

LINE OUT level : - 8.2dB to - 7.2dB (0.301 to 0.338V)

Level Difference between Channels : within 1dB

Confirm the DOLBY OUT level does not change in playback mode while changing the mode from playback to stop several times.

Adjustment Location : MD-A and MD-B boards

**Record Bias Adjustment** DECK B

**Procedure :**

1. record mode

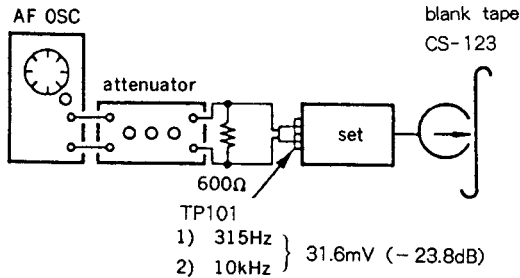

2. playback mode

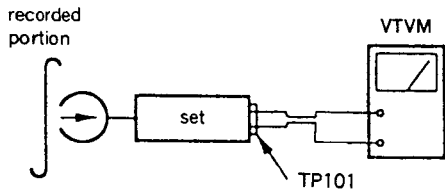

Confirm playback the signal recorded in step 1 become adjustment level as follows.

If these levels do not adjustment level, adjustment the RV12 (L-CH) and RV22 (R-CH) to repeat step 1 and 2.

**Adjustment level :** Playback output of 315Hz to playback output of 10kHz : -0.5dB to 0.5dB.

**Adjustment Location :** MD-B board

**Record Level Adjustment** DECK B

**Procedure :**

1. record mode

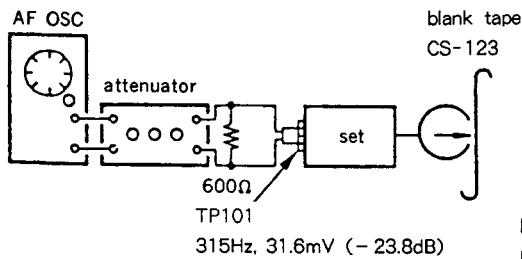

2. playback mode

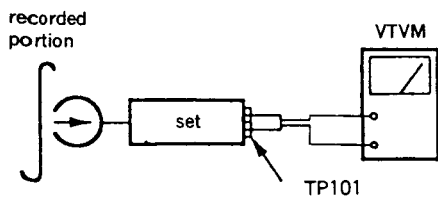

Confirm playback the signal recorded in step become adjustment level as follows.

If these levels do not adjustment level, adjustment the RV201 (L-CH) and RV301 (R-CH) to repeat step 1 and 2.

**Adjustment Level :**

LINE OUT level : -23.8dB ± 0.5dB (29 to 33.4mV)

**Adjustment Location :** main board

**Adjustment Location :**

Mechanism deck - rear side -

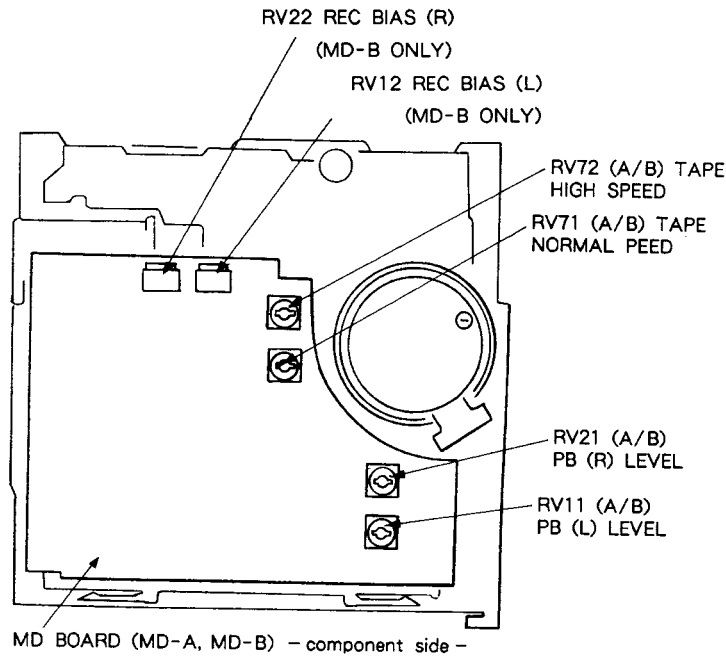

sub board - component side -

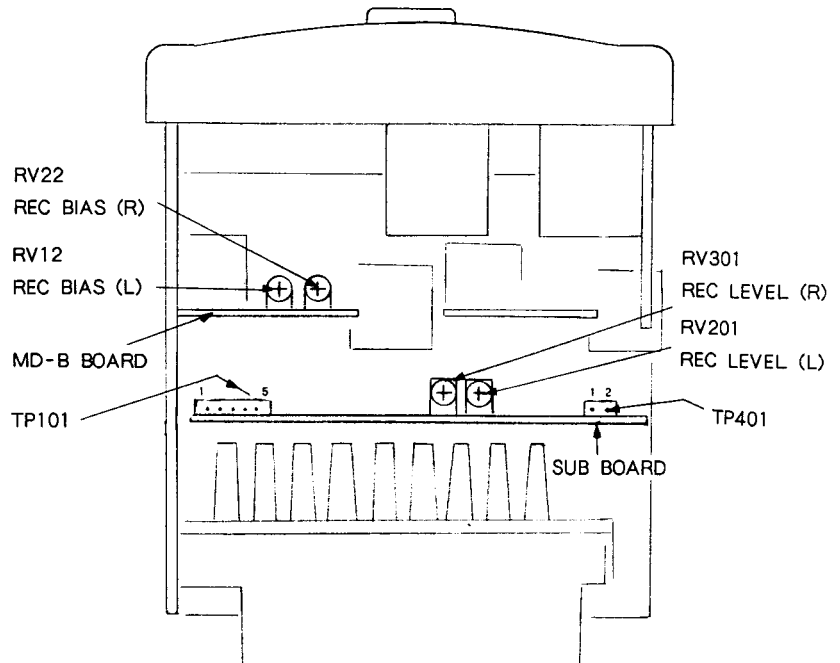

Note : As a front-end (FE1) is difficult to repair if faulty, replace it with new one.

- Repeat the procedures in each adjustment several times, and the frequency coverage and tracking adjustments should be finally done by trimmer capacitors.

### TUNER SECTION

#### FM SECTION ADJUSTMENTS

Setting :

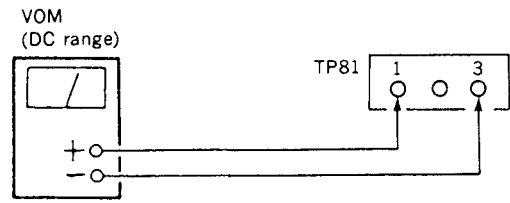
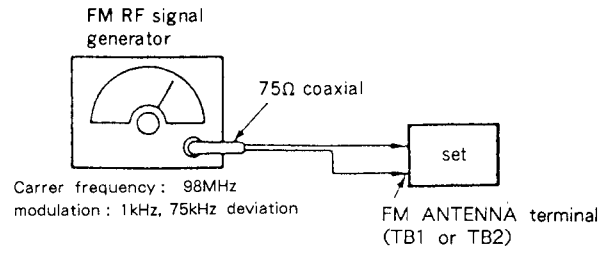

#### FM Discriminator Alignment (NULL Check)

Band : FM

Procedure :

- Supply a 1mV (60dBμ) 98MHz signal from the ANTENNA terminal.
- Tune the set to 98MHz.
- Adjust IFT82 for 0V reading on the VOM.

Note : FM tuned indication lighting level adjustment should be made after FM discriminator alignment.

Adjustment Location: main board

#### FM Tuned Indication Lighting Level Adjustment

Band : FM

Procedure :

- Supply a 24 μV (25dBμ) 98MHz signal from the ANTENNA terminal.
- Tune the set to 98MHz.
- Adjust RV81 so that the **TUNED** light up.

#### AM SECTION ADJUSTMENTS

Setting :

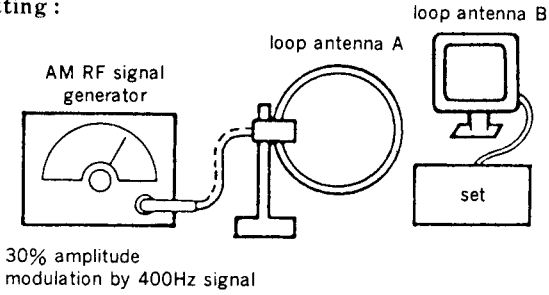

#### MW Tuned Indication Lighting Level Adjustment

Band : MW

Procedure :

- Set loop antenna A so that the loop antenna, B input level becomes (55dBμ) 0.45mV.
- Tune the set to 999kHz.
- Adjust the RV82 so that the **TUNED** light up.

#### SW OSC Voltage Adjustment

Band : SW

Procedure :

- Connect the VOM to TP (OSC).
- Tune the set to 5.95MHz.
- Adjust T2 for 0.9 to 1.1V reading on the VOM.
- Tune the set to 17.90MHz.
- Adjust CT22 for 8.3 to 8.7V reading on the VOM.

#### SW Tracking Adjustment

Band : SW

Procedure :

- Connect the VOM to speaker terminal.
- Adjust for a maximum reading on VOM.

Signal generator and Set frequency	Adjustment part
7.0MHz	T1
17.0MHz	CT21

Adjustment Location : main board —component side—

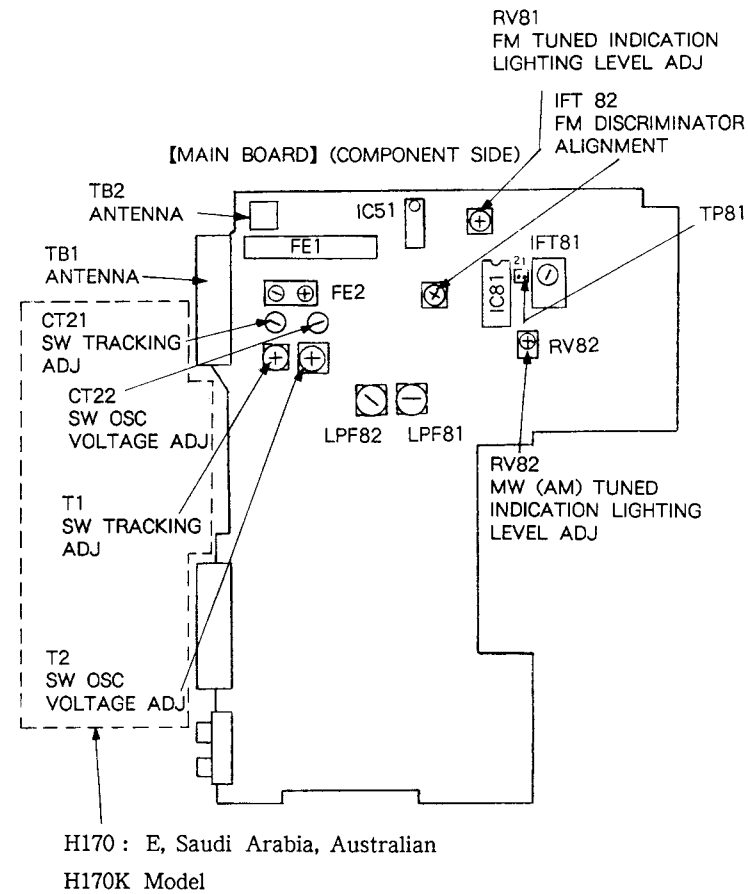

### CD SECTION

Note :

- CD Block basically constructed to operate without adjustment. Therefore, check each item in order given.
- Use YEDS-18 disc (3-702-101-01) unless otherwise indicated.
- Use the oscilloscope with more than 10MΩ impedance.
- Clean an object lens by an applicator with neutral detergent when the signal level is low than specified value with the following checks.

#### S Curve Check

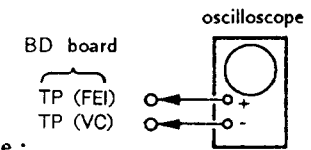

Procedure :

- Connect oscilloscope to test point TP (FEI) on BD board.
- Connect between test point TP (FE) and TP (VC) by lead wire.
- Turned Power switch on and actuate the focus search. (actuate the focus search when disc table is moving in and out.)
- Check the oscilloscope waveform (S curve) is symmetrical between A and B. And confirm peak to peak level within  $3 \pm 1V_{p-p}$ .

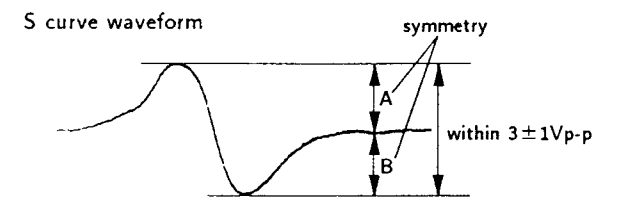

- After check, remove the lead wire connected in step 2.

Note : • Try to measure several times to make sure that the ratio of A : B or B : A is more than 10 : 7.

- Take sweep time as long as possible and light up the brightness to obtain best waveform.

#### Procedure

- Connect
- Turn F
- Put di
- Confir

Note :

Clear RF s  
can be clea  
form.

RF signal

#### E-F Balan

Procedure:

- Connect
- Connect
- Turn
- Put di
- Confir

Traver

0V

- Remo

Block basically constructed to operate without adjustment. Therefore, check each item in order given.

Use YEDS-18 disc (3-702-101-01) unless otherwise indicated.

Use the oscilloscope with more than 10MΩ impedance.

Clean an object lens by an applicator with neutral detergent when the signal level is low than specified value with the following checks.

**RF Level Check**

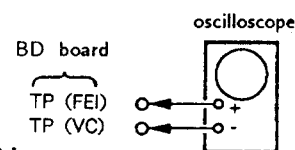

Procedure :  
Connect oscilloscope to test point TP (FEI) on BD board.

Connect between test point TP (FE) and TP (VC) with lead wire.

Turn Power switch on and actuate the focus search. (actuate the focus search when disc table moving in and out.)

Check the oscilloscope waveform (S curve) is symmetrical between A and B. And confirm peak level within 3 ± 1Vp-p.

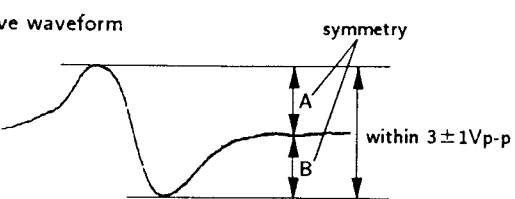

After check, remove the lead wire connected in step 2.

• Try to measure several times to make sure that the ratio of A : B or B : A is more than 10 : 7.

• Take sweep time as long as possible and light up the brightness to obtain best waveform.

**RF Level Check**

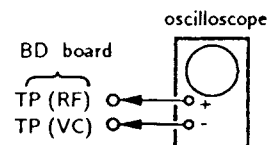

- Procedure :
1. Connect oscilloscope to test point TP (RF) on BD board.
  2. Turn Power switch on.
  3. Put disc (YEDS-18) in and playback.
  4. Confirm that oscilloscope waveform is clear and check RF signal level is correct or not.

Note :  
Clear RF signal waveform means that the shape “◇” can be clearly distinguished at the center of the waveform.

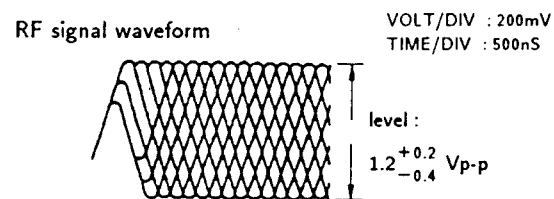

**E-F Balance Check**

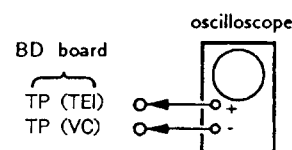

- Procedure:
1. Connect test point TP (ADJ) to ground and TP (TEO) to TP (VC) with lead wire.
  2. Connect oscilloscope to test point TP (TEI) on BD board.
  3. Turn Power switch on.
  4. Put disc (YEDS-18) in and playback.
  5. Confirm that the oscilloscope waveform is symmetrical on the top and bottom in relation to 0V, and check this level.

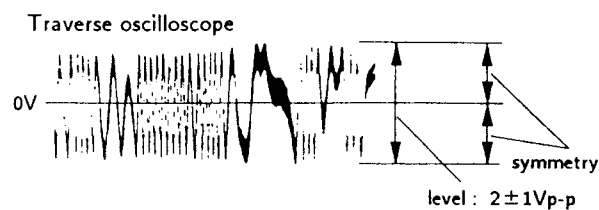

6. Remove the lead wire connected in step 1.

**RF PLL Free-run Frequency Check**

- Procedure :
1. Connect frequency counter to test point (PCLK) with lead wire.
  2. Turn Power switch on.
  3. Confirm that reading on frequency counter is 4.3218MHz.

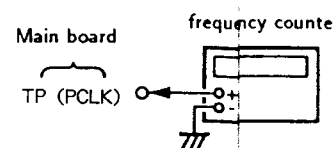

**Focus/Tracking Gain**

This gain has a margin, so even if it is slightly off. There is no problem.  
Therefore, do not perform, this adjustment.  
Please note that it should be fixed to mechanical center position when you moved and do not know original position.

Adjustment Locations :  
[BD board]

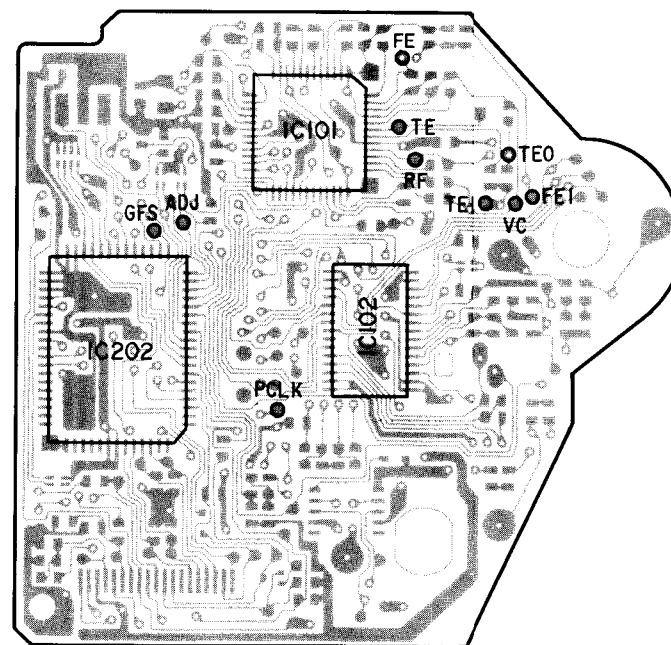

**6-1. SEMICONDUCTOR LEAD LAYOUTS**

<p><b>CXA1372AQ</b></p> <p>(TOP VIEW)</p>	<p><b>STK-4132MK2</b></p> <p>MARKING SIDE VIEW</p>	<p><b>2SC3112</b></p>
<p><b>CXD2500AQ</b></p> <p>MARKING SIDE VIEW</p>	<p><b>TA7272P</b></p> <p>MARKING SIDE VIEW</p>	<p><b>2SK246-GR3</b></p>
<p><b>GP1U59XB</b></p> <p>1 Vout 2 Vcc 3 GND</p>	<p><b>DTA114ES</b> <b>DTA144ES</b> <b>DTC114ES</b> <b>DTC143TS</b> <b>2SB1094-LK</b> <b>2SC2603-EF</b> <b>2SC2724-CD</b> <b>2SC3622A-LK</b> <b>2SD2012</b></p>	<p><b>DTZ3.9B</b> <b>1SS352</b> <b>1SS355</b></p> <p>ANODE CATHODE</p>
<p><b>LA6525M</b></p> <p>(TOP VIEW)</p>	<p><b>DTA124ES</b> <b>DTC144ES</b> <b>2SA1175-HFE</b></p> <p>LETTER SIDE</p>	<p><b>EC10DS2</b></p> <p>Cathode Anode</p>
<p><b>M5218AFP</b></p>	<p><b>PST572E</b></p> <p>IN GND OUT</p>	<p><b>HZS6A1L</b> <b>UZL-9M2</b> <b>11ES2</b></p> <p>Cathode Anode</p>
		<p><b>NJL5165K-B</b></p>



6-2. CIRCUIT BOARDS LOCATION

SML1260S  
SML1460E  
SML1960A  
SEL4510-D

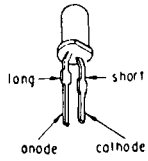

UZ36BSB  
1N4148M

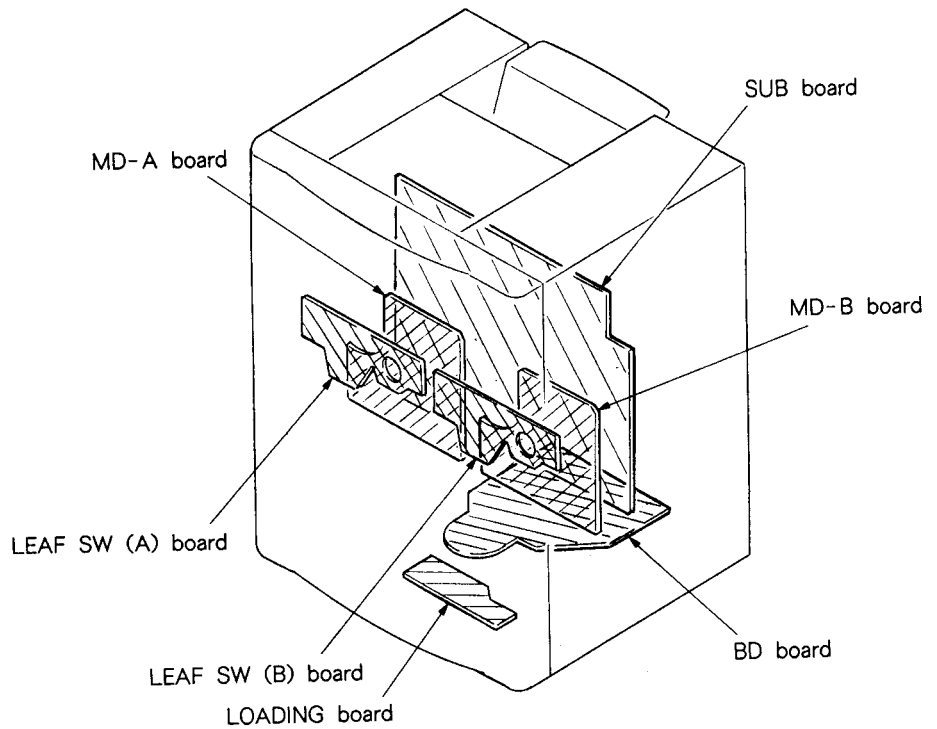
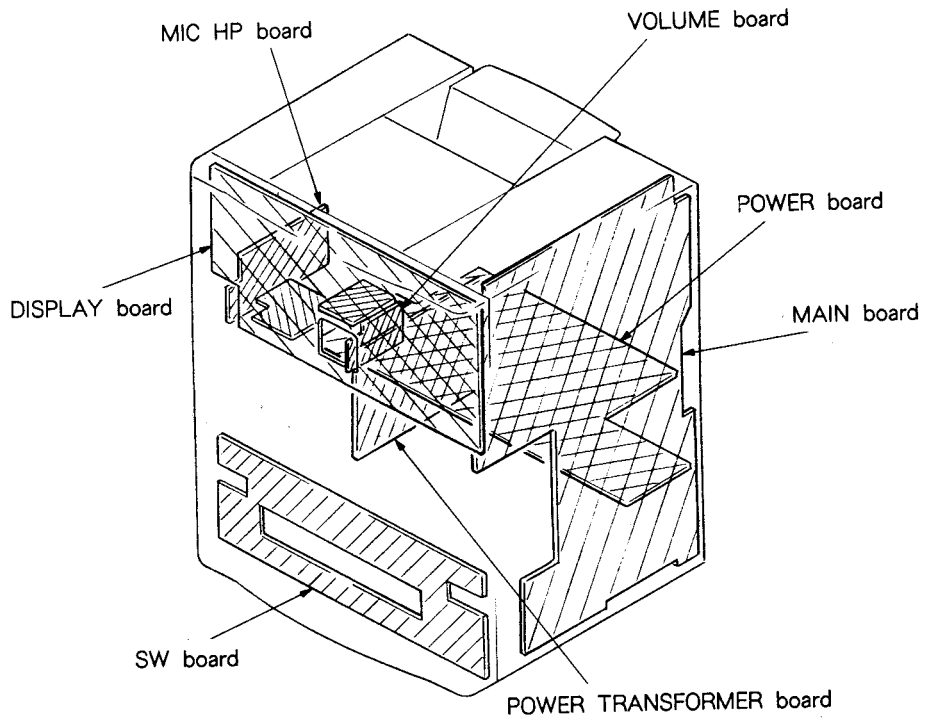
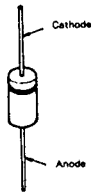

• IC Block Diagrams

• IC801 STK-4132MK2

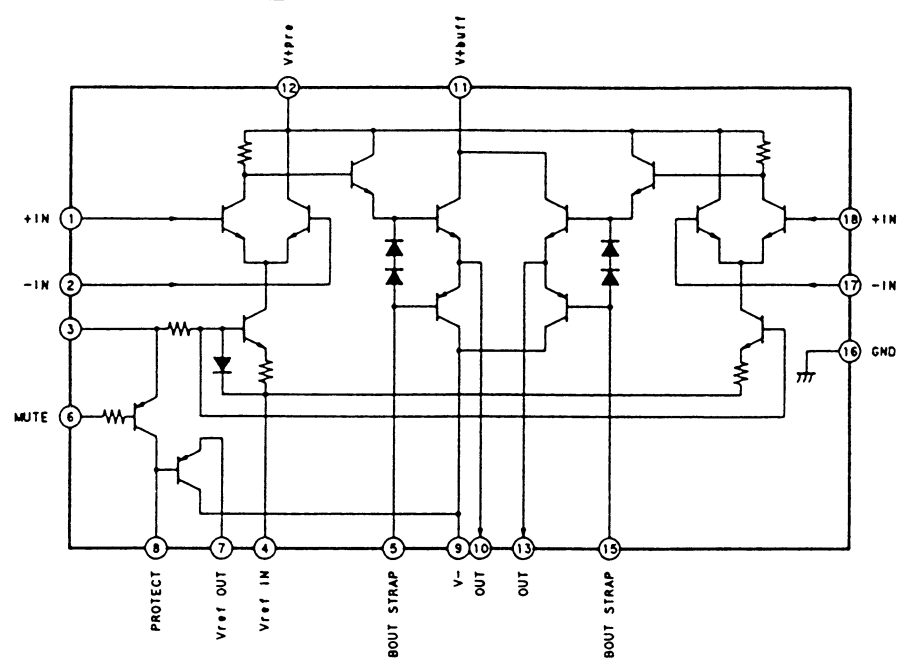

• IC201, 251 M5229P

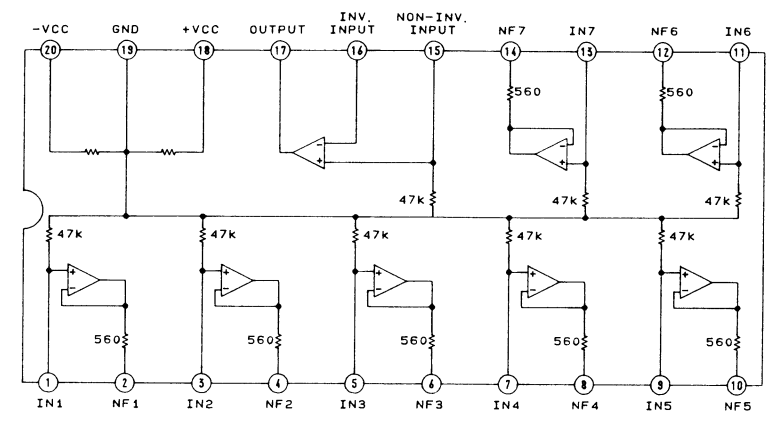

• IC231, 236 MC14066BCP

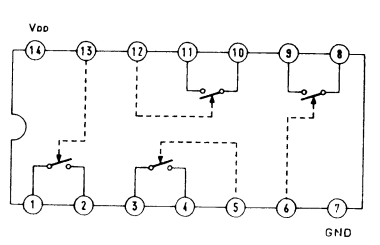

• IC406 LB1639

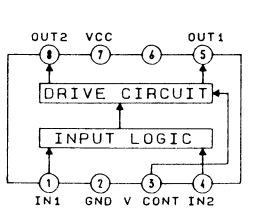

• IC81 LA1851N

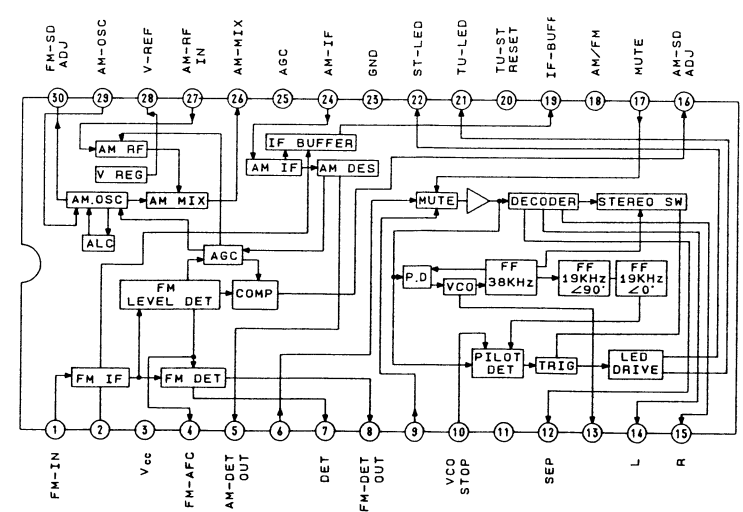

• Semiconductor Location

Ref. No.	Location	Ref. No.	Location
D21 (*2)	C-4	Q5 (*1)	B-8
D81	H-7	Q5 (*2)	B-3
D202	J-8	Q7 (*1)	D-9
D205 (*3)	F-12	Q7 (*2)	D-4
D206	F-11	Q8 (*1)	D-9
D207 (*3)	C-11	Q8 (*2)	D-4
D208	G-8	Q9 (*1)	B-8
D401	H-21	Q9 (*2)	B-3
D801	D-23	Q10 (*1)	B-9
D810	J-25	Q10 (*2)	B-4
D901	B-26	Q11 (*2)	E-4
D902	B-26	Q51 (*1)	D-2
D904	E-22	Q51 (*2)	D-7
D905	B-24	Q52 (*1)	D-2
D906	B-25	Q52 (*2)	D-7
D907	C-24	Q53 (*1)	D-6
D909	E-21	Q54 (*1)	D-6
D910	C-23	Q101	G-10
D914	C-11	Q102	F-9
D915	B-22	Q103	I-9
D916	B-22	Q201	F-16
D921	F-12	Q202	H-10
D923	B-27	Q231 (*3)	E-12
D924	C-27	Q232	E-11
		Q233	H-10
IC51	F-7	Q234	J-8
IC81	H-8	Q235 (*3)	B-12
IC201	G-17	Q236 (*3)	C-12
IC231	E-13	Q237	I-9
IC232	D-12	Q251	D-17
IC234	F-17	Q252	H-10
IC236 (*3)	C-12	Q301	D-14
IC251	E-18	Q302	D-13
IC301 (*1)	C-18	Q901	E-27
IC302	D-15	Q903	E-26
IC406	H-21	Q904	E-27
IC801	E-25	Q905	E-21
IC901	C-26	Q906	E-22
IC902	E-14	Q907	E-21
IC9001	B-10	Q908	E-24
		Q911	C-14
Q1 (*1)	D-8	Q8001	D-21
Q1 (*2)	D-3	Q9001	B-11
Q2 (*4)	D-7	Q9002	B-11
Q4 (*1)	E-9	Q9003	B-10
Q4 (*2)	F-4		

(\*1): H170/AEP, EE, G, IT, H700 MODEL  
 (\*2): H170/E, Saudi Arabia, Australian, H170K MODEL  
 (\*3): H170K MODEL  
 (\*4): H170 G, IT MODEL

6-3. PRINTED WIRING BOARDS - MAIN SECTION -

• See page 34, 35 for Semiconductor Lead Layouts and Circuit Boards

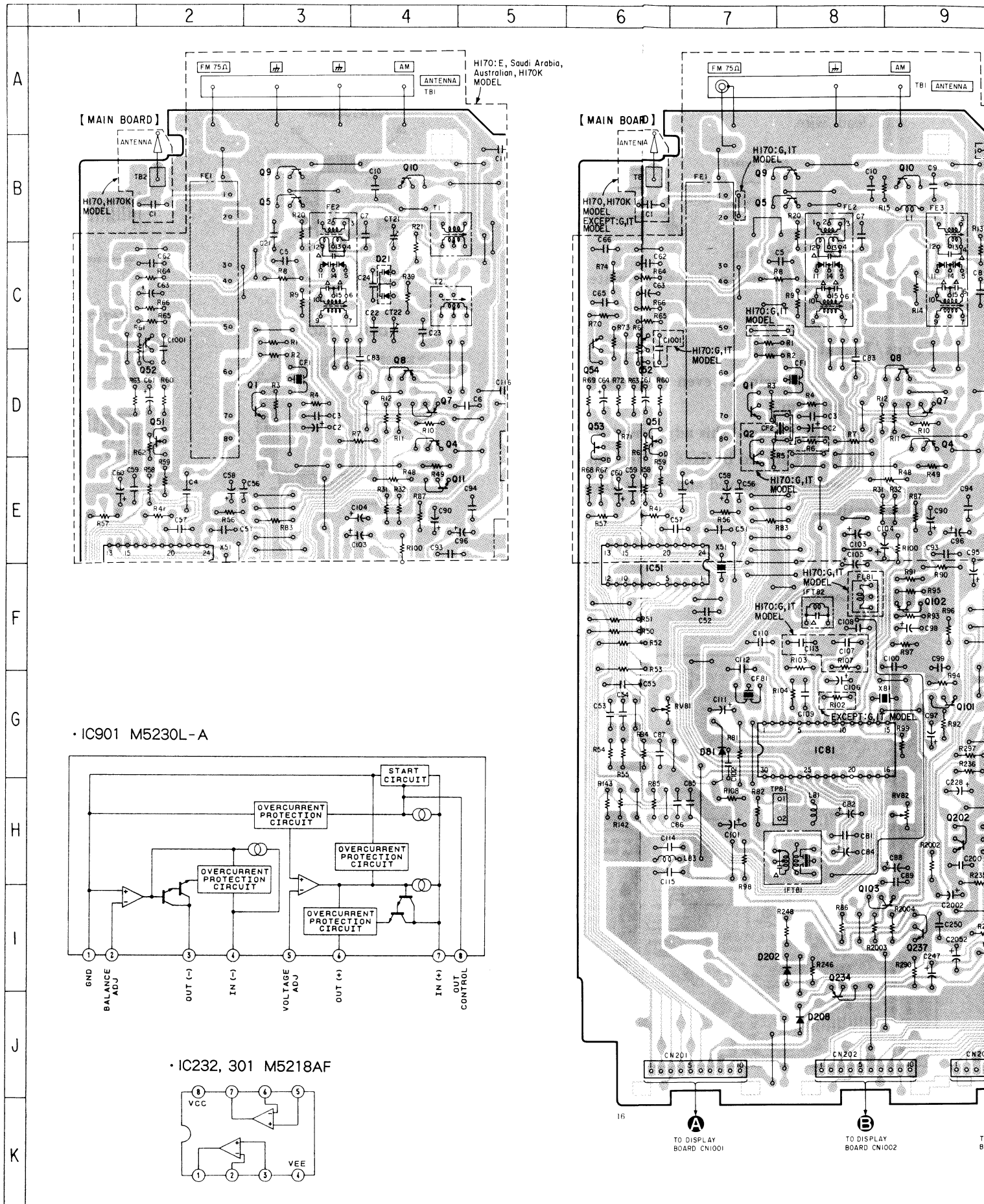

• IC901 M5230L-A

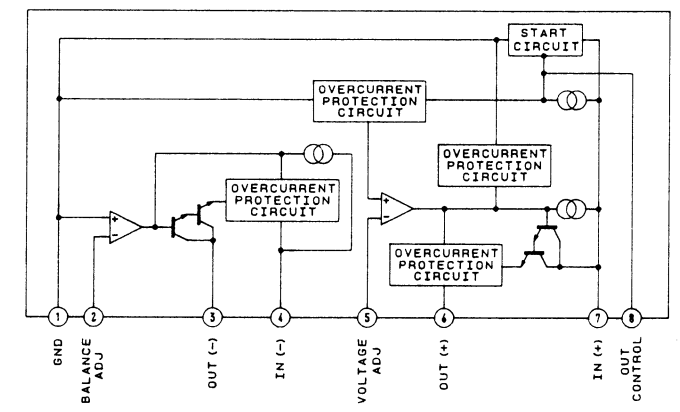

• IC232, 301 M5218AF

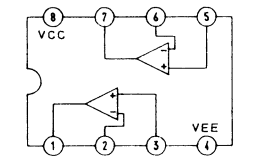

4	5	6	7	8	9	10	11	12	13	14	15	16	17	18	19	20	21	22
---	---	---	---	---	---	----	----	----	----	----	----	----	----	----	----	----	----	----

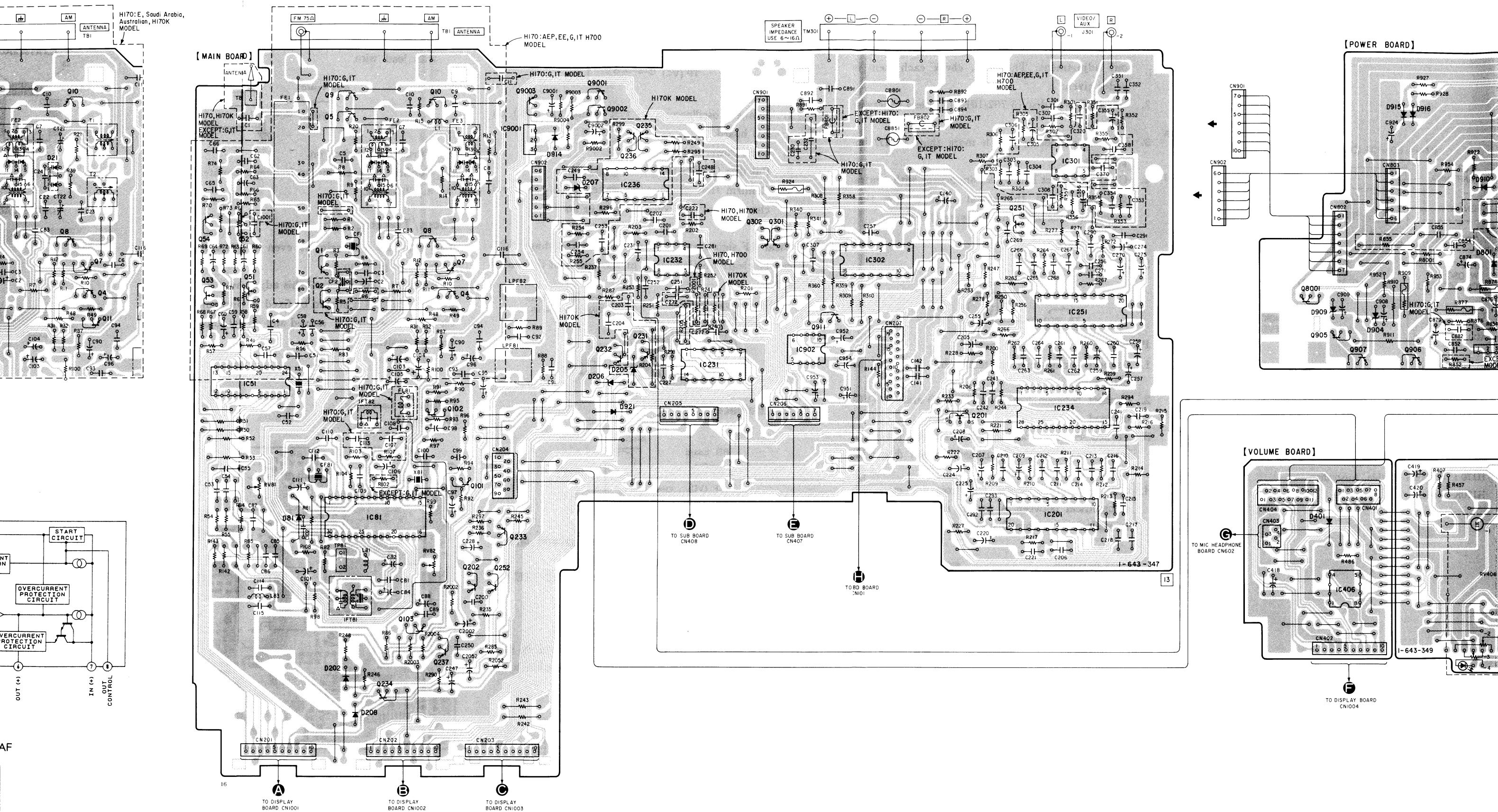

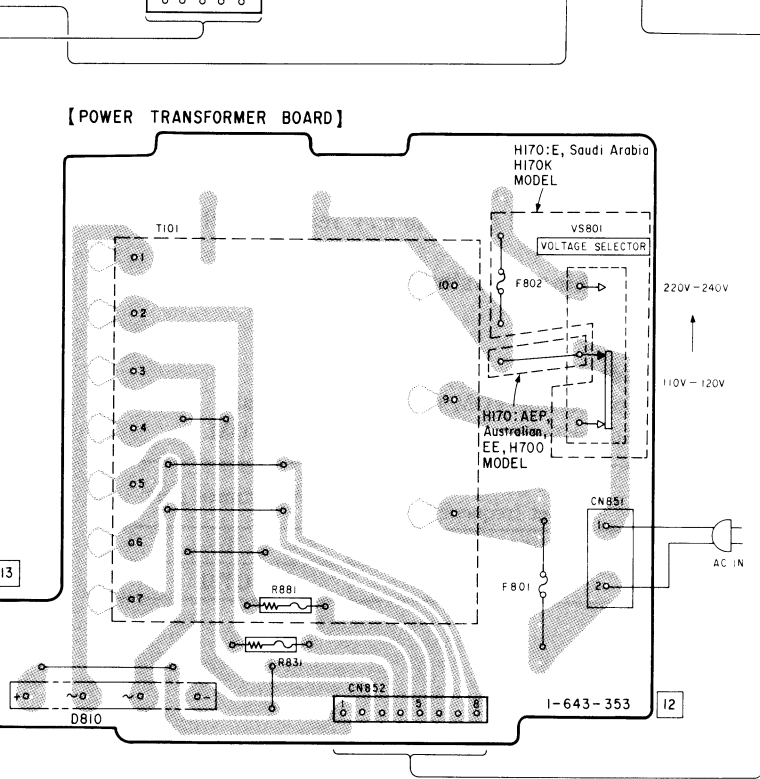
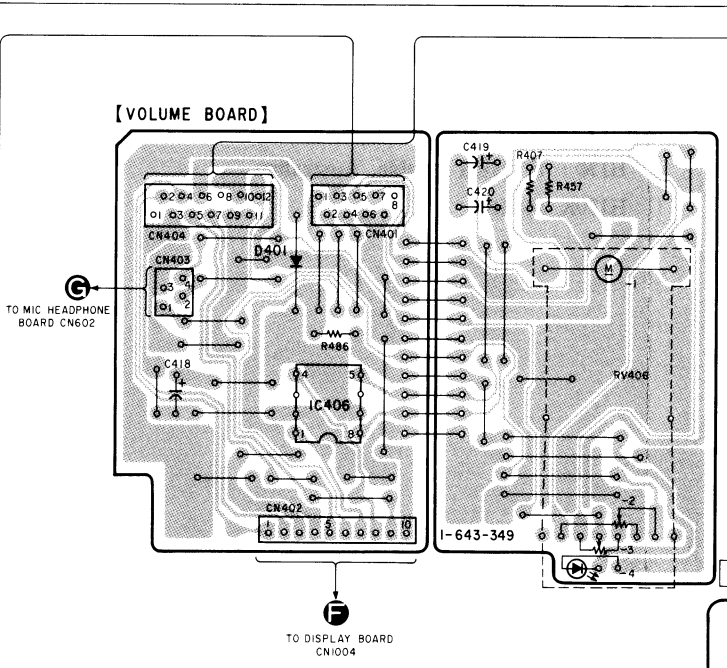
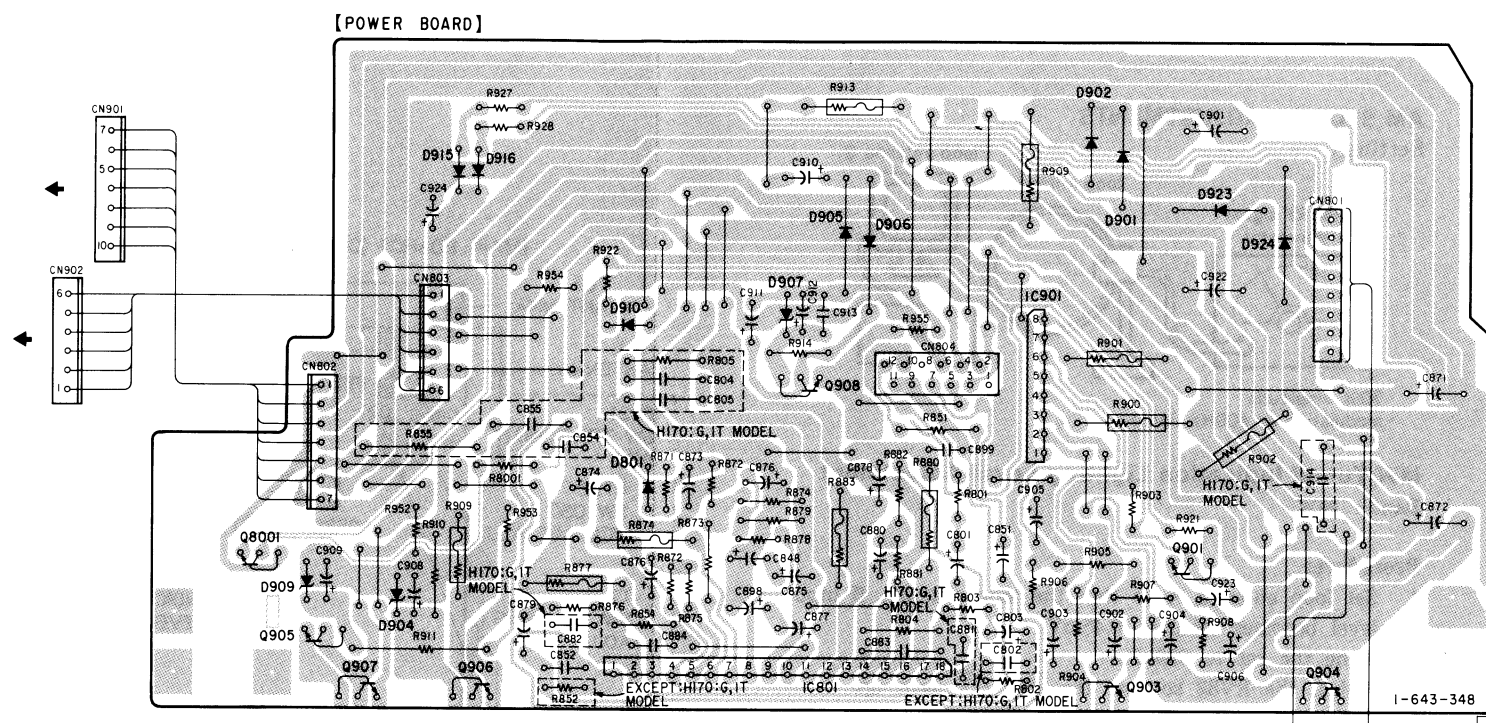
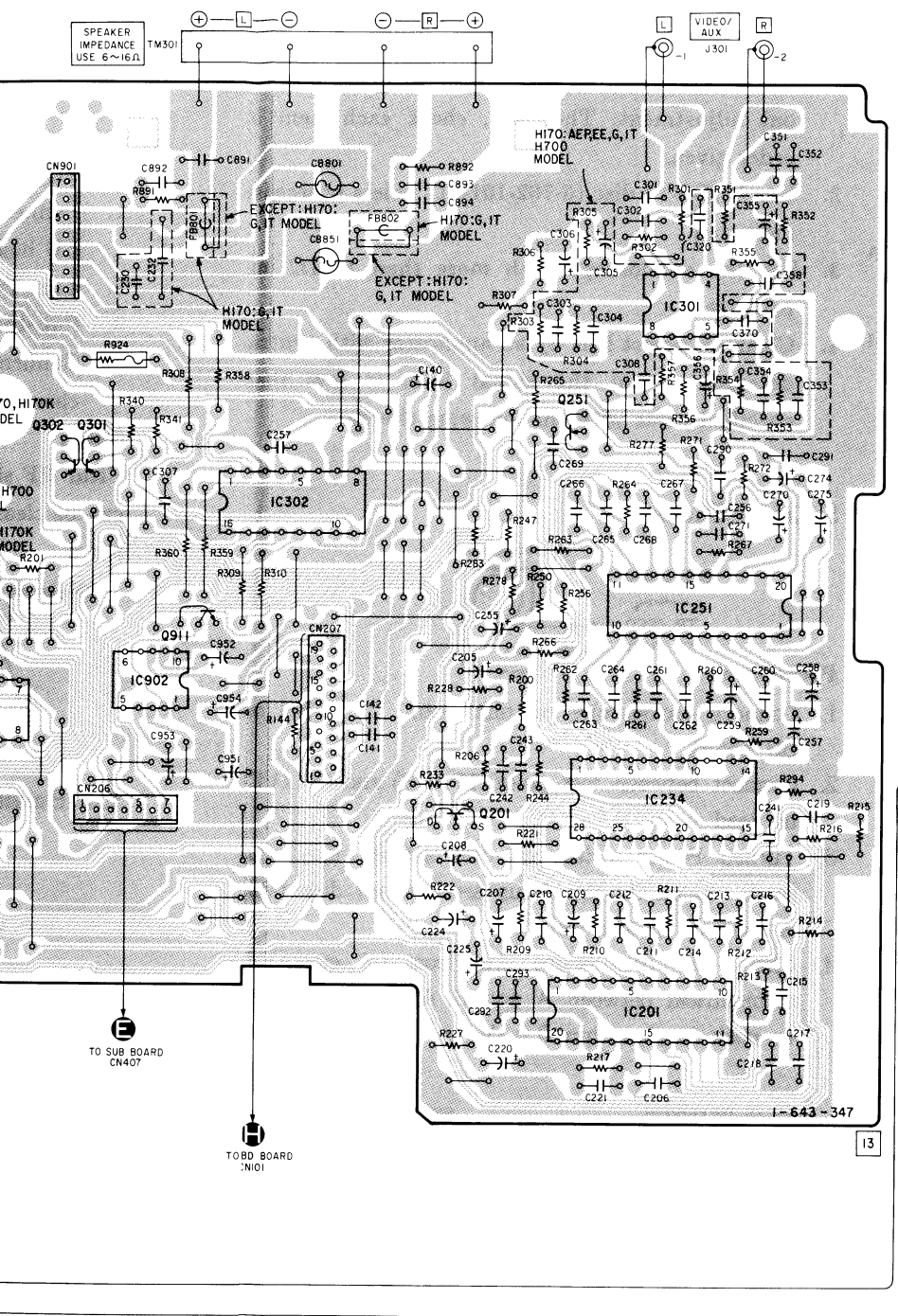

6-4. SCHEMATIC DIAGRAM - MAIN SECTION - •See page 64 for Wave forms and Note.

1	2	3	4	5	6	7	8	9
---	---	---	---	---	---	---	---	---

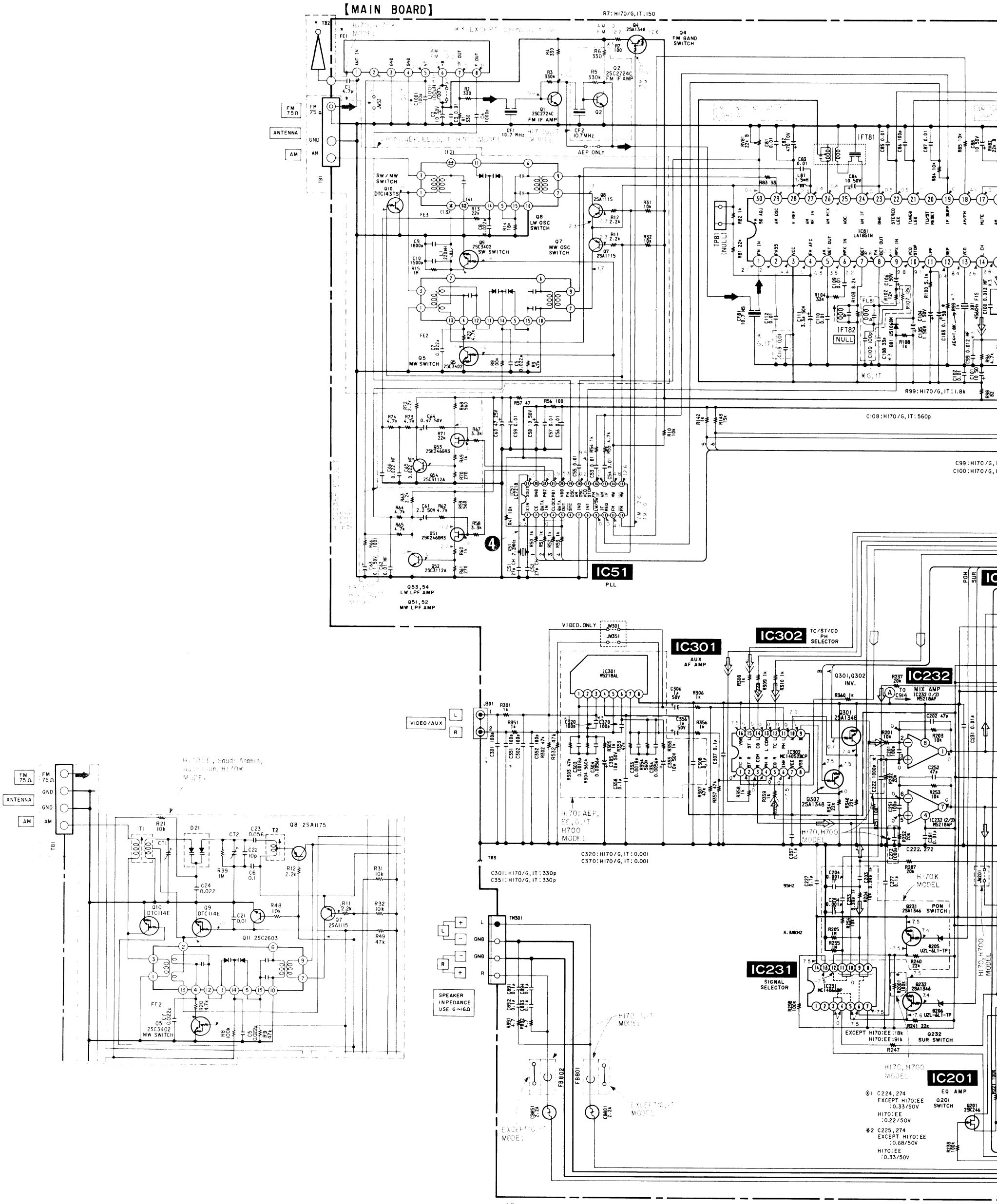

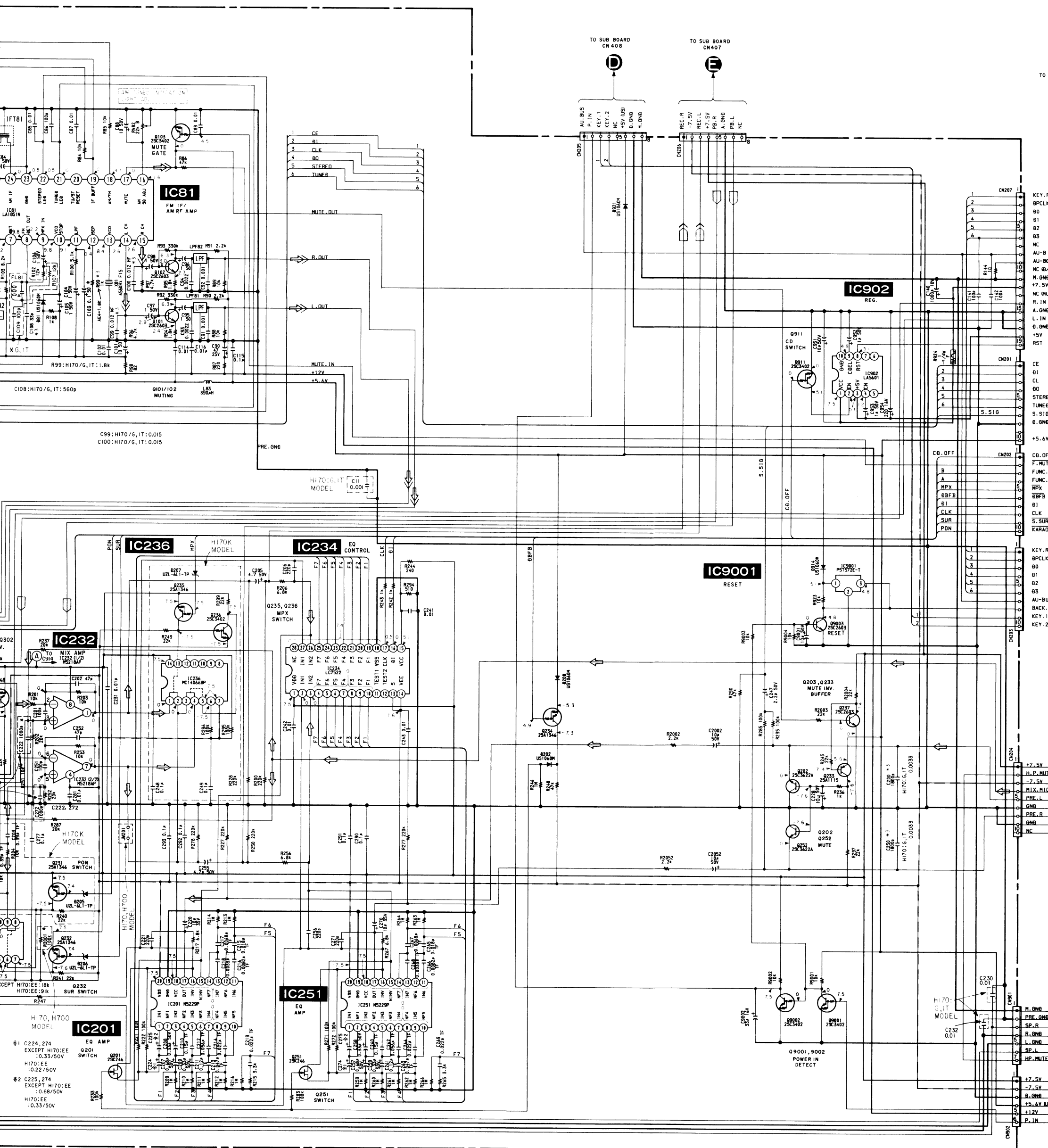



[E BOARD]

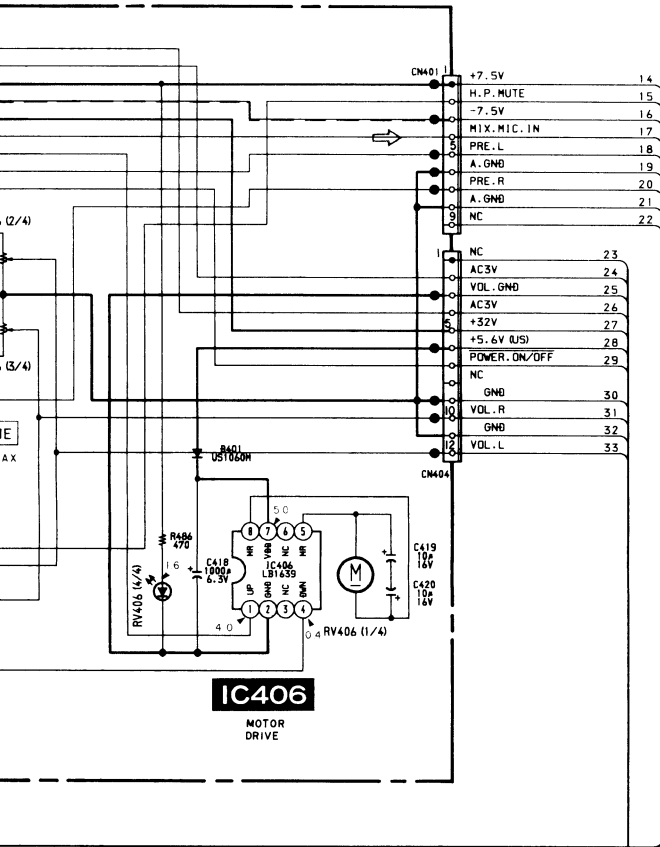

[POWER TRANSFORMER BOARD]

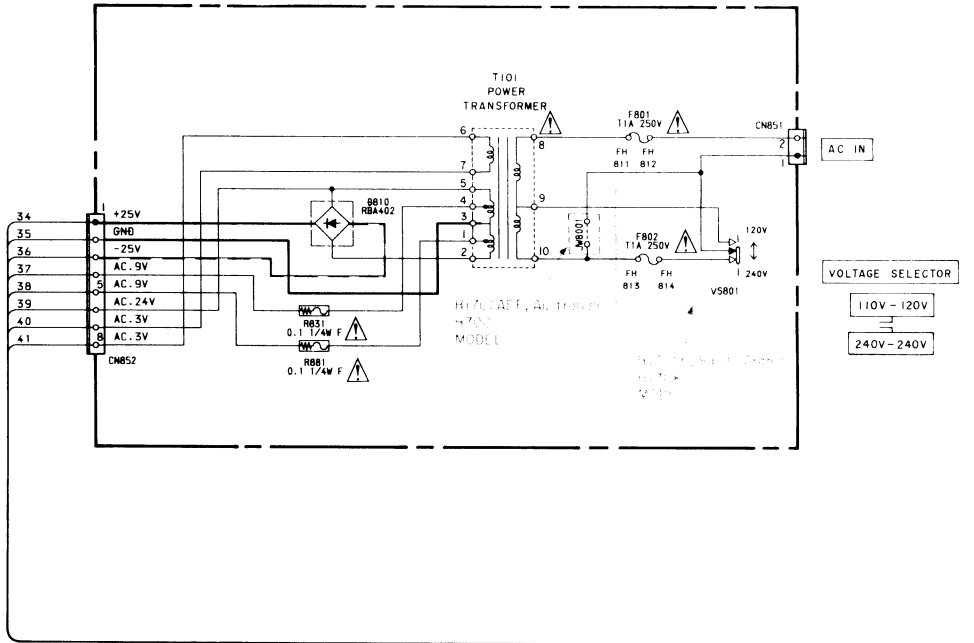

[POWER BOARD]

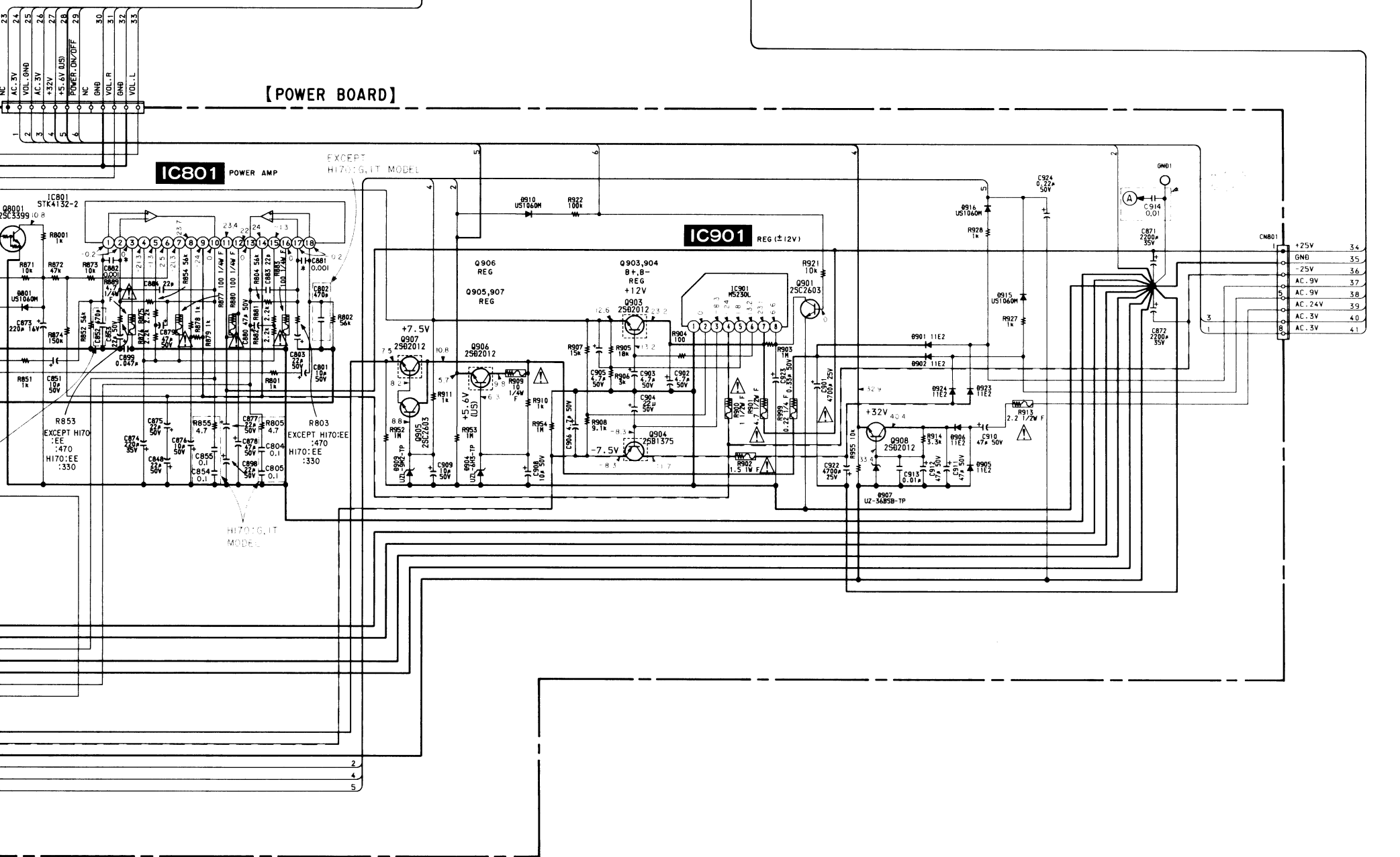



6-5. SCHEMATIC DIAGRAM - SUB SECTION - •See page 64 for Wave forms and Note. •See page 67 for IC Pin Description.

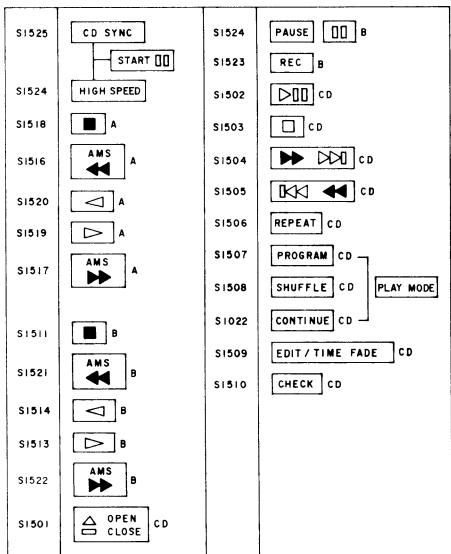
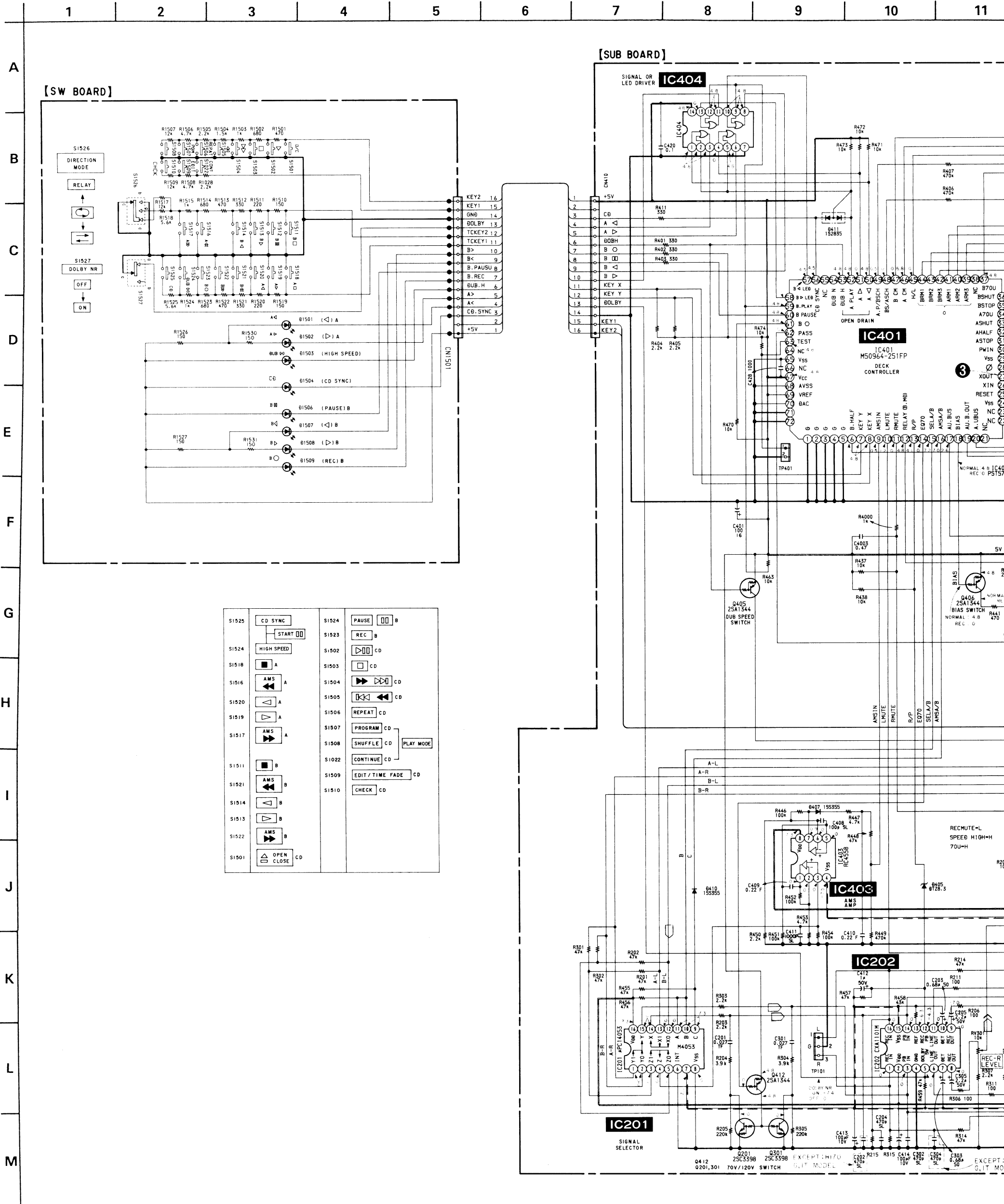

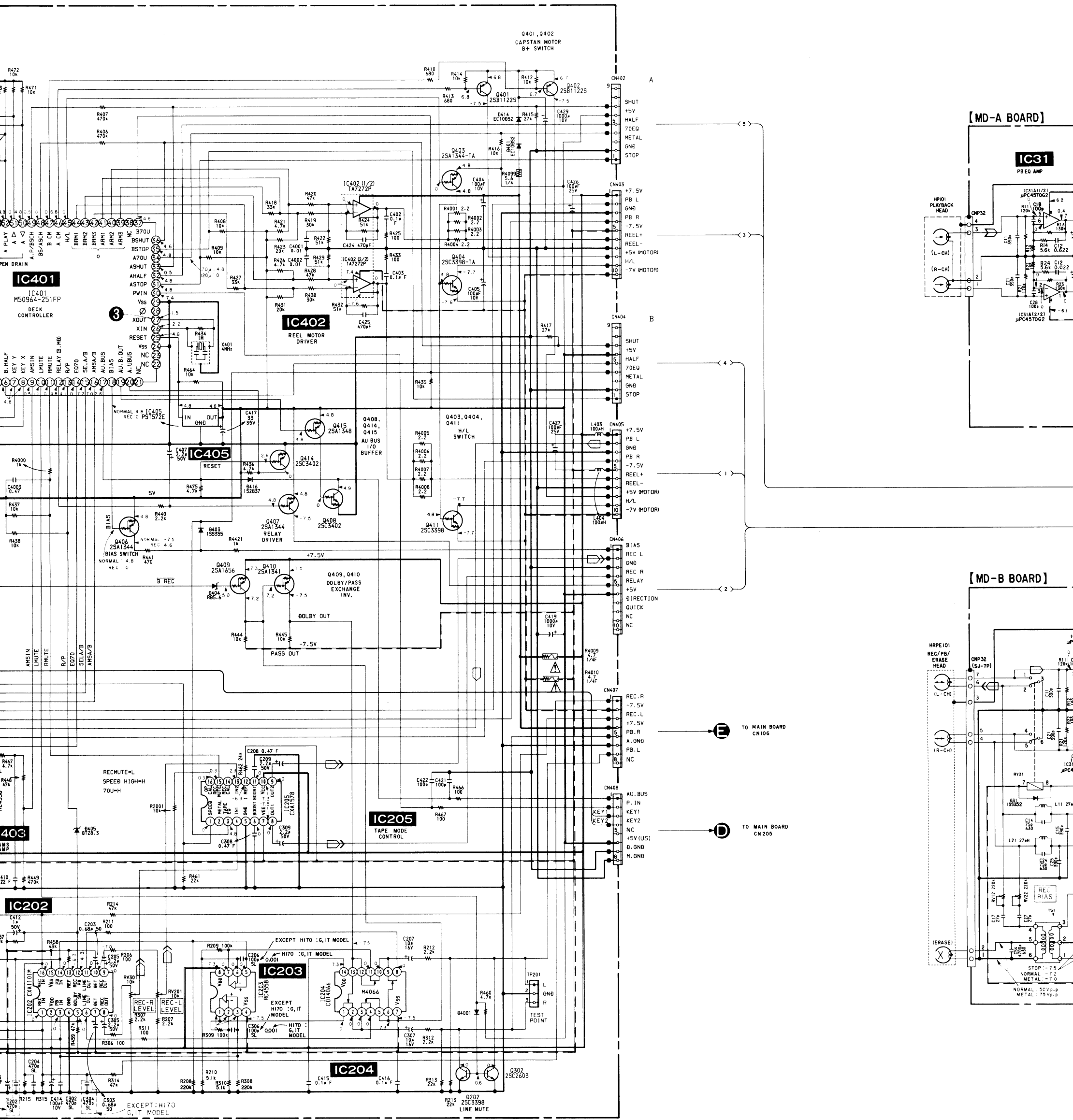

【MD-A BOARD】

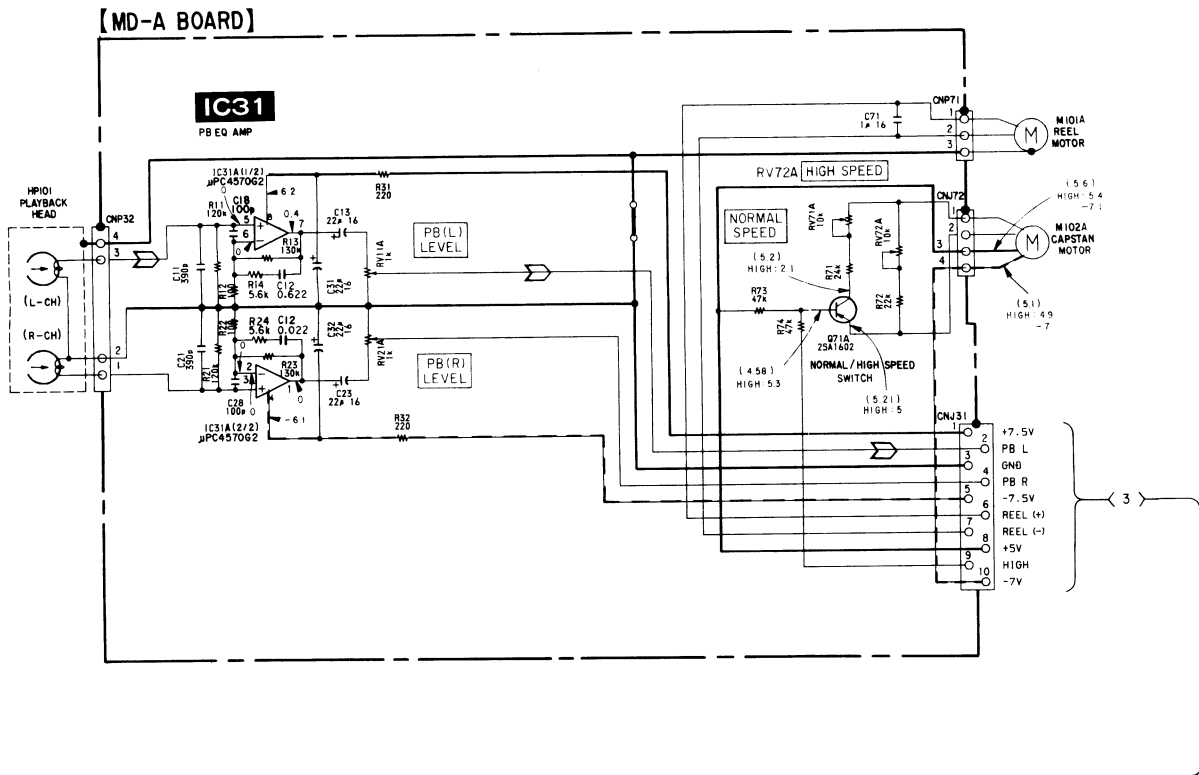

【LEAF SW (A) BOARD】 (A DECK) TCM-190 RAI3A

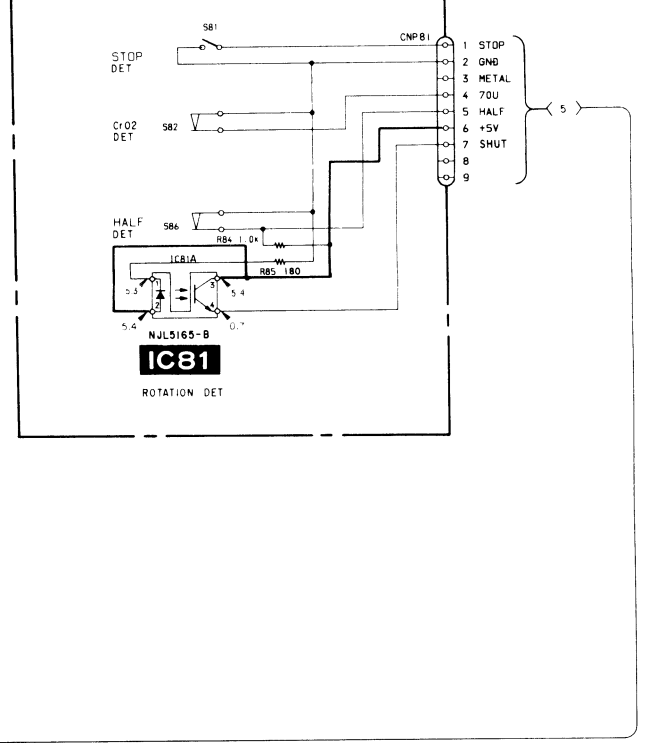

【MD-B BOARD】

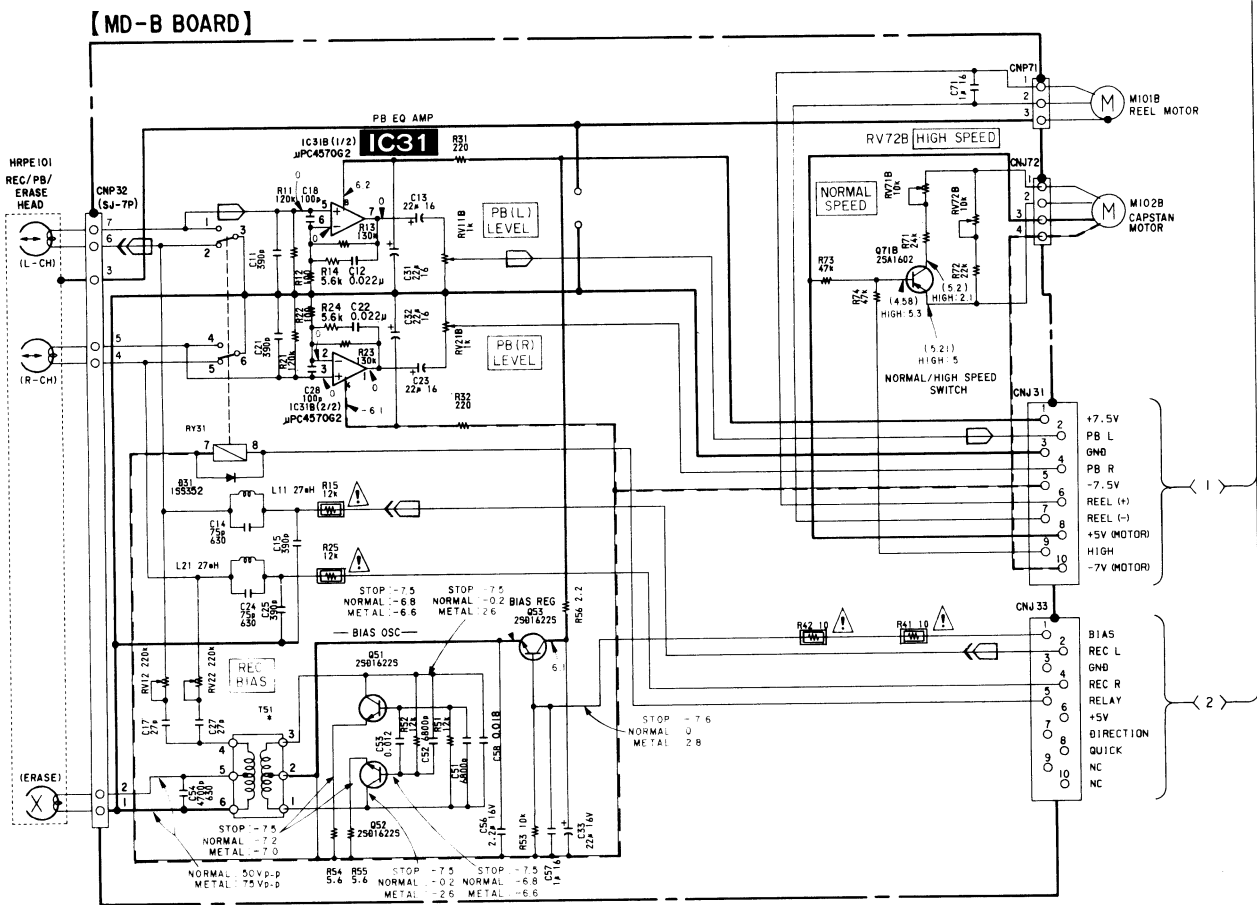

【LEAF SW (B) BOARD】 (B DECK) RB22A

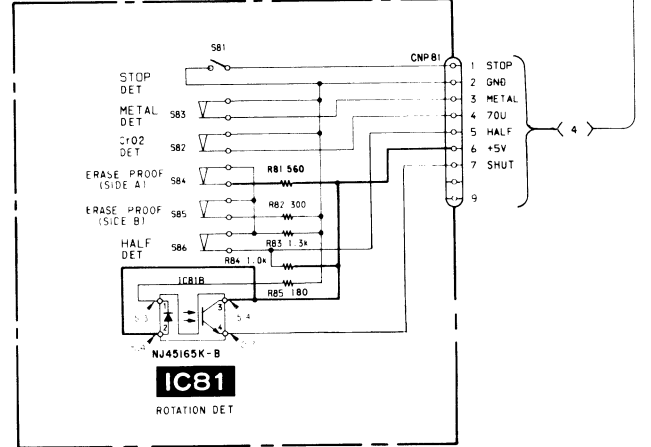

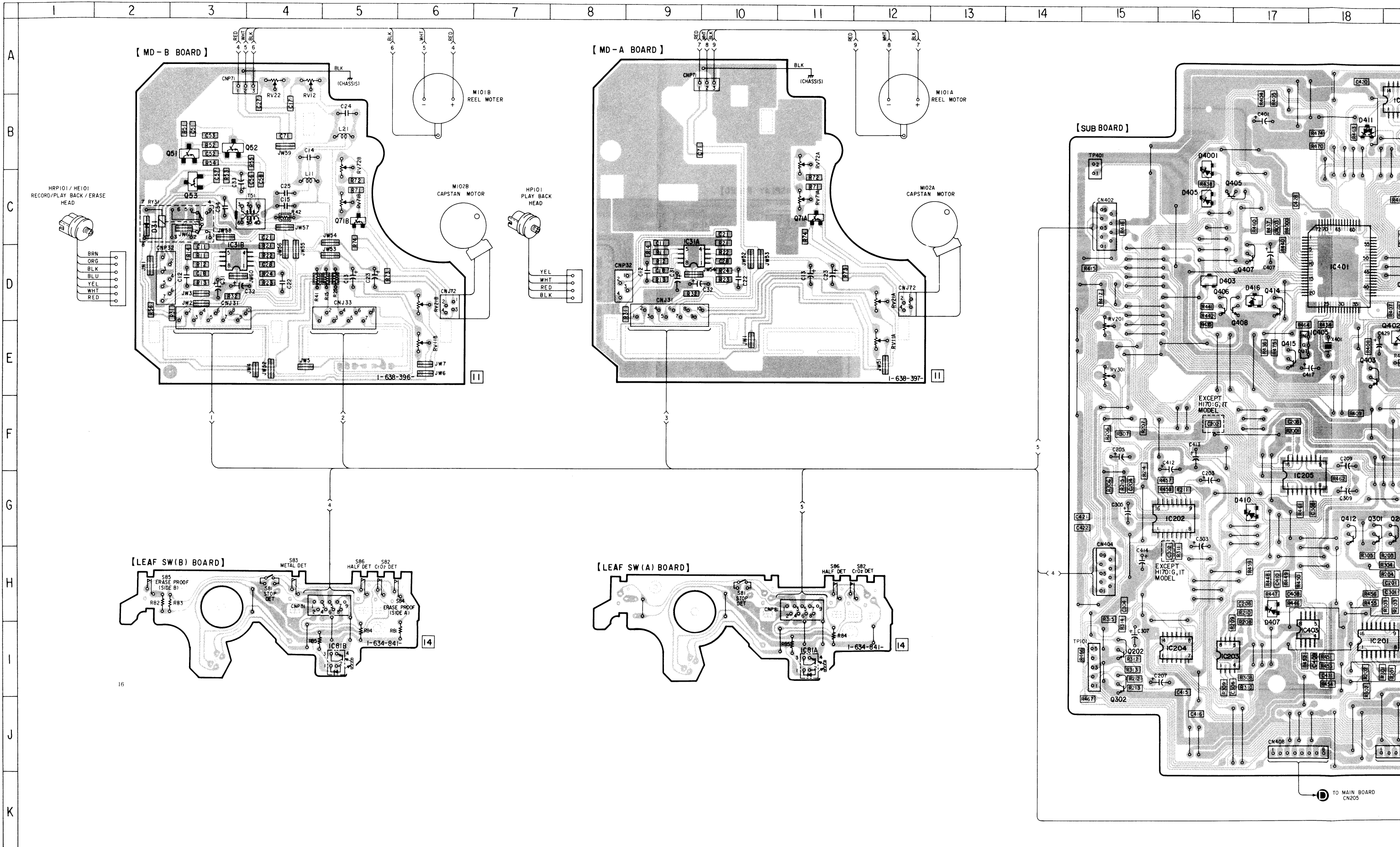

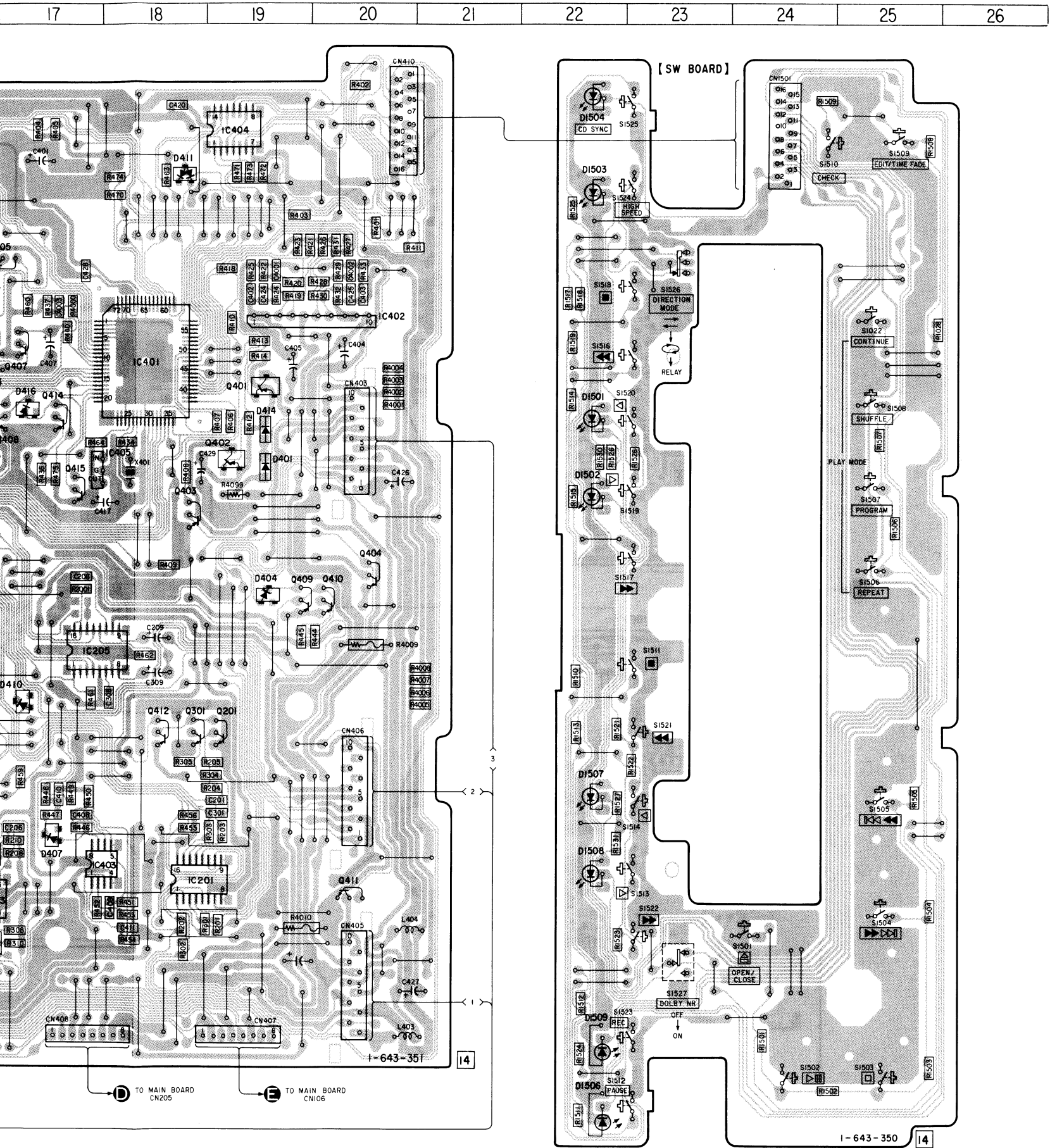

• Semiconductor Location

Ref. No.	Location
D31	C-2
D401	E-19
D403	D-16
D404	F-19
D405	C-16
D407	I-17
D410	G-17
D411	B-18
D414	D-19
D416	D-17
D1501	D-22
D1502	E-22
D1503	B-22
D1504	A-22
D1506	K-22
D1507	H-22
D1508	I-22
D1509	J-22
D4001	B-16
IC31A	D-9
IC31B	D-3
IC81A	I-11
IC81B	I-5
IC201	I-18
IC202	G-16
IC203	I-16
IC204	I-16
IC205	G-17
IC401	D-18
IC402	C-20
IC403	I-18
IC404	B-19
IC405	E-18
Q51	B-3
Q52	B-3
Q53	C-3
Q71A	C-11
Q71B	C-5
Q201	G-19
Q202	I-15
Q301	G-18
Q302	I-15
Q401	D-19
Q402	E-19
Q403	E-18
Q404	F-20
Q405	C-17
Q406	D-16
Q407	D-17
Q408	D-17
Q409	F-19
Q410	F-20
Q411	I-20
Q412	G-18
Q414	D-17
Q415	E-17

• IC Block Diagrams

• IC202 CXA1101M

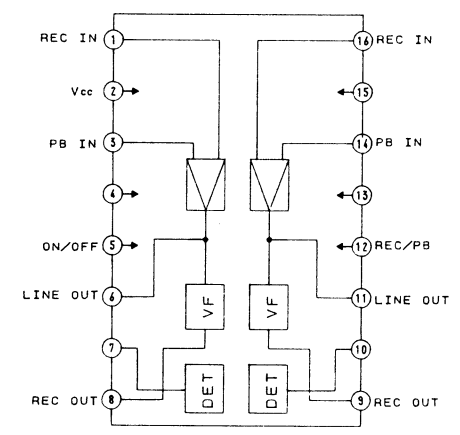

• IC201 CD4053BCM

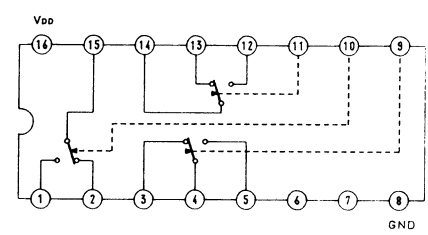

• IC402 TA7272P

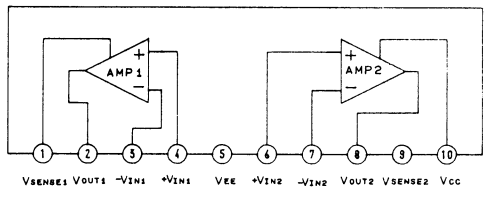

• IC Block Diagrams

• IC601 M50197FP

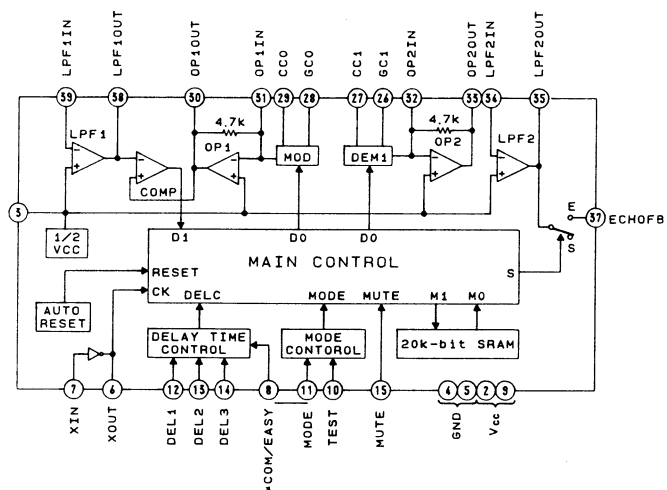

• IC1004 CD4052BCM

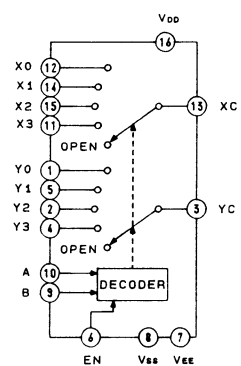

• Semiconductor Location

Ref. No.	Location
D101	D-4
D201	D-3
D601 (*1)	D-7
D602 (*1)	E-8
D1001	F-21
D1002	D-21
D1004	F-13
D1005	F-21
D1007	C-20
D1030	D-19
D1031	D-18
D1051	F-20
D1052	E-19
D1053	E-19
D1054	E-19
D1055	D-18
D1057 (*1)	E-16
D1058	D-21
D1059	C-21
IC101	B-4
IC102	C-4
IC103	D-4
IC106	F-14
IC201	H-4
IC202	C-3
IC203	H-3
IC301	G-3
IC302	G-2
IC501	C-16
IC601 (*1)	E-8
IC602	D-10
IC1001	G-15
IC1002	G-21
IC1003	C-19
IC1004	D-20
IC1005	F-13
IC1006	G-18
IC1007	G-19
IC1008	D-21
Q101	B-3
Q201	E-4
Q601	D-16
Q602	F-9
Q603 (*1)	F-9
Q1001	D-21
Q1002	D-20
Q1003	D-20
Q1004	D-21
Q1051	E-13

(\*1): H170K MODEL

6-7. PRINTED WIRING BOARDS - DISPLAY SECTION - • See page 34, 35 for Semiconductor Lead Layouts and Circuit Boards Location.

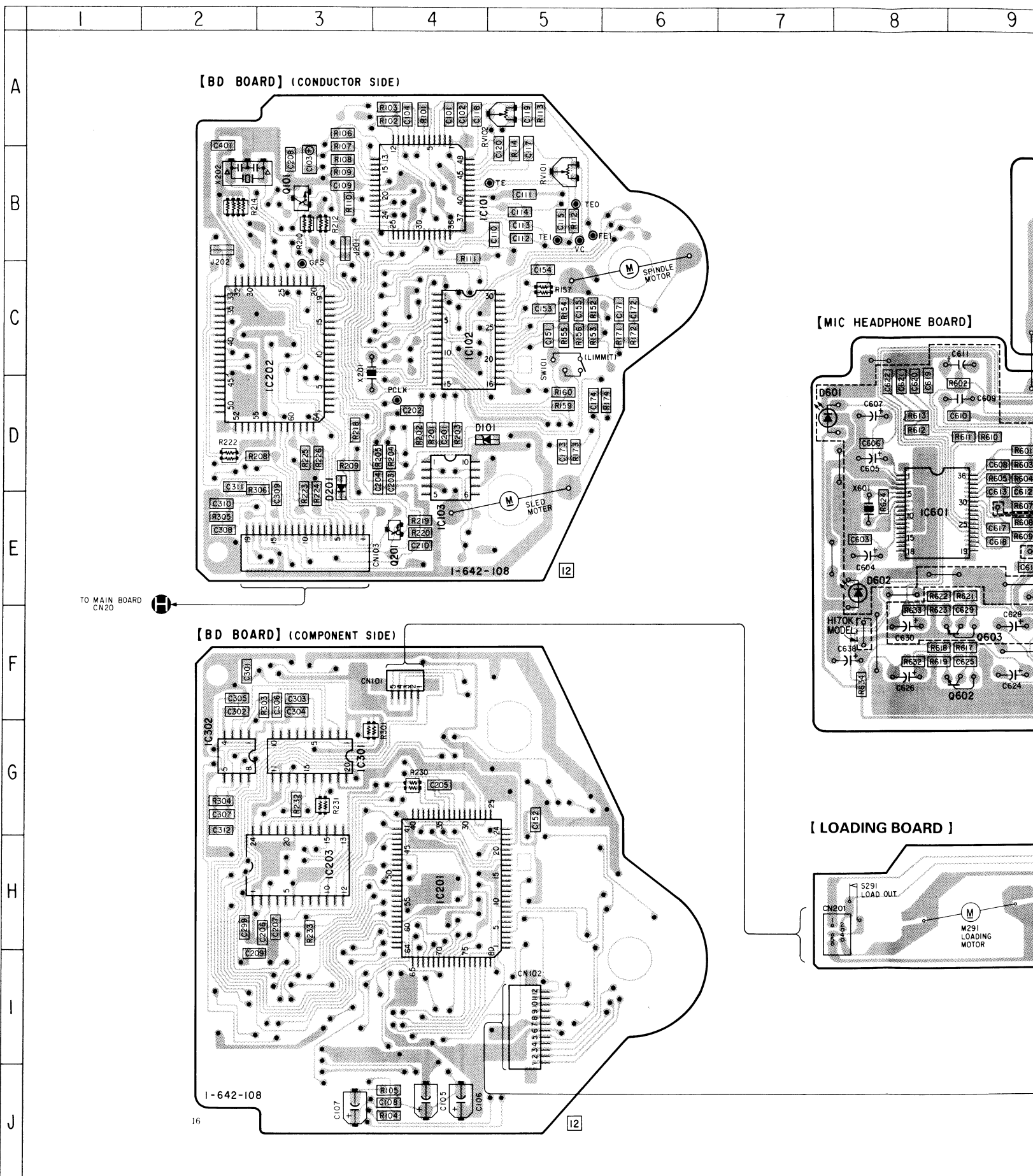

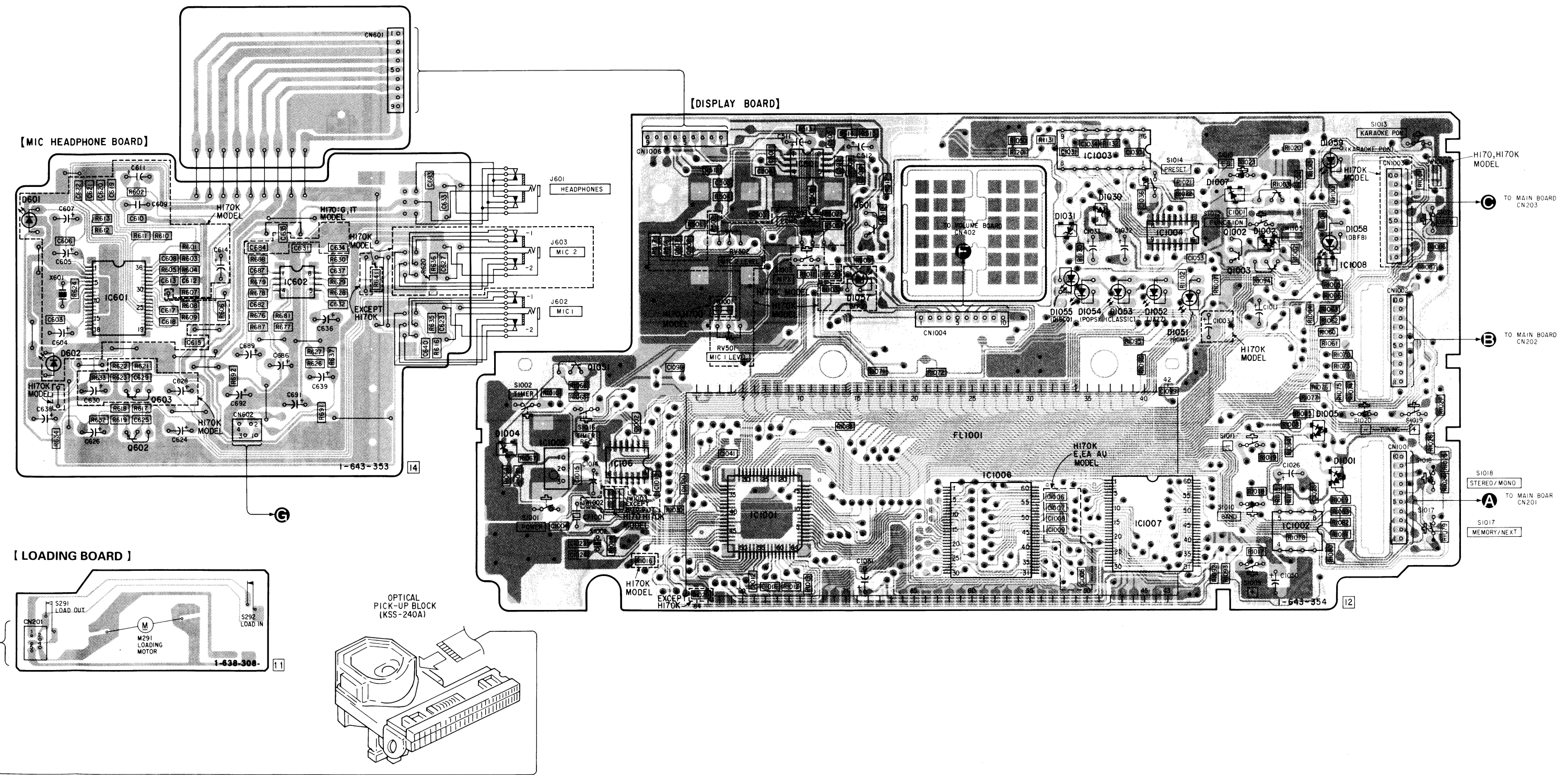

1 2 3 4 5 6 7 8 9 10 11

A  
B  
C  
D  
E  
F  
G  
H  
I  
J  
K  
L  
M  
N

[ DISPLAY BOARD ]

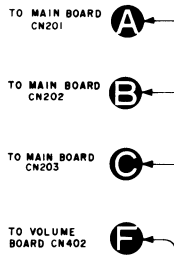
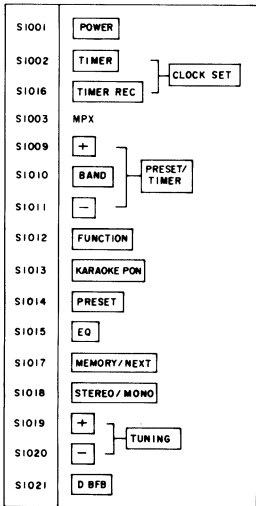

[ MIC HEADPHONE BOARD ]

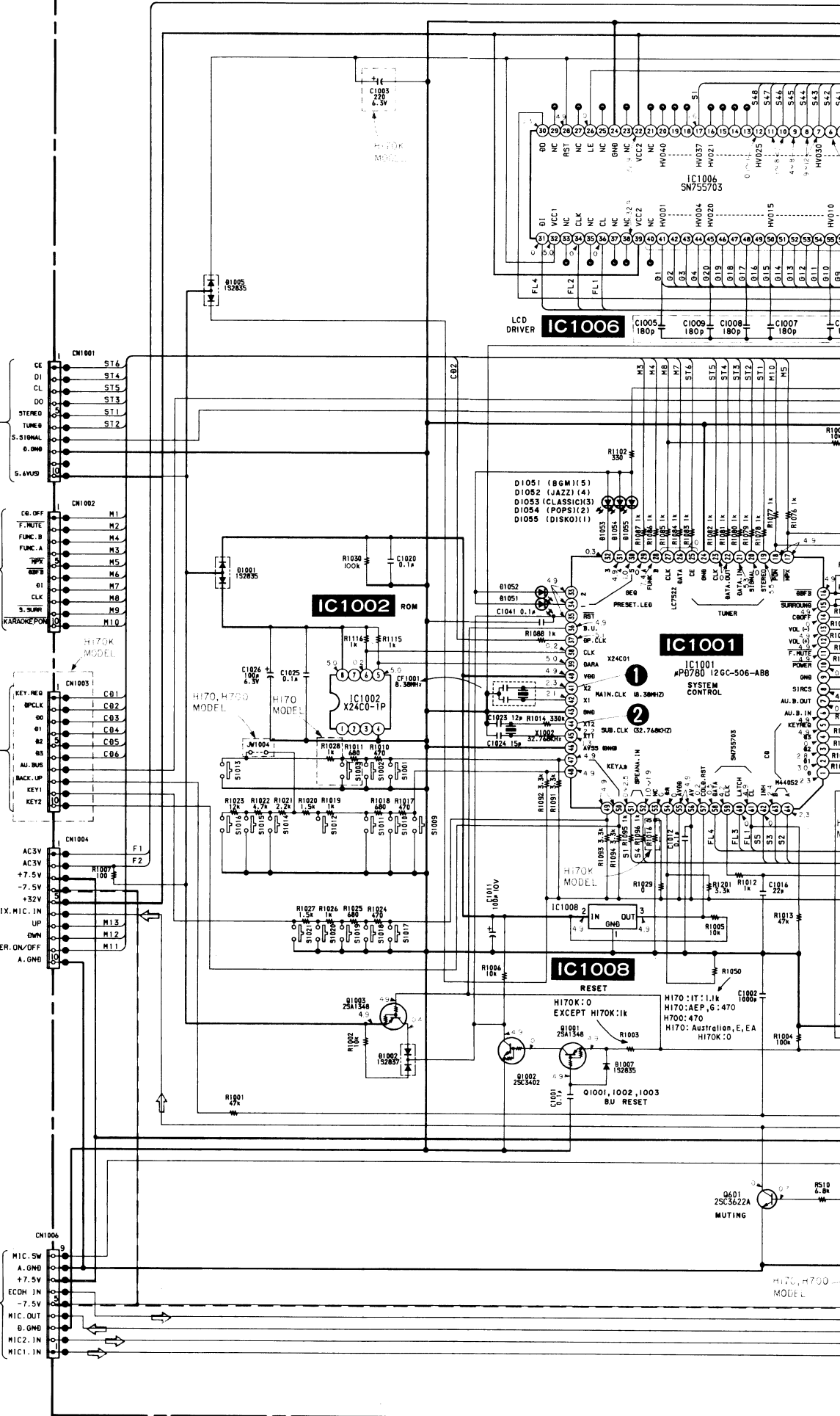
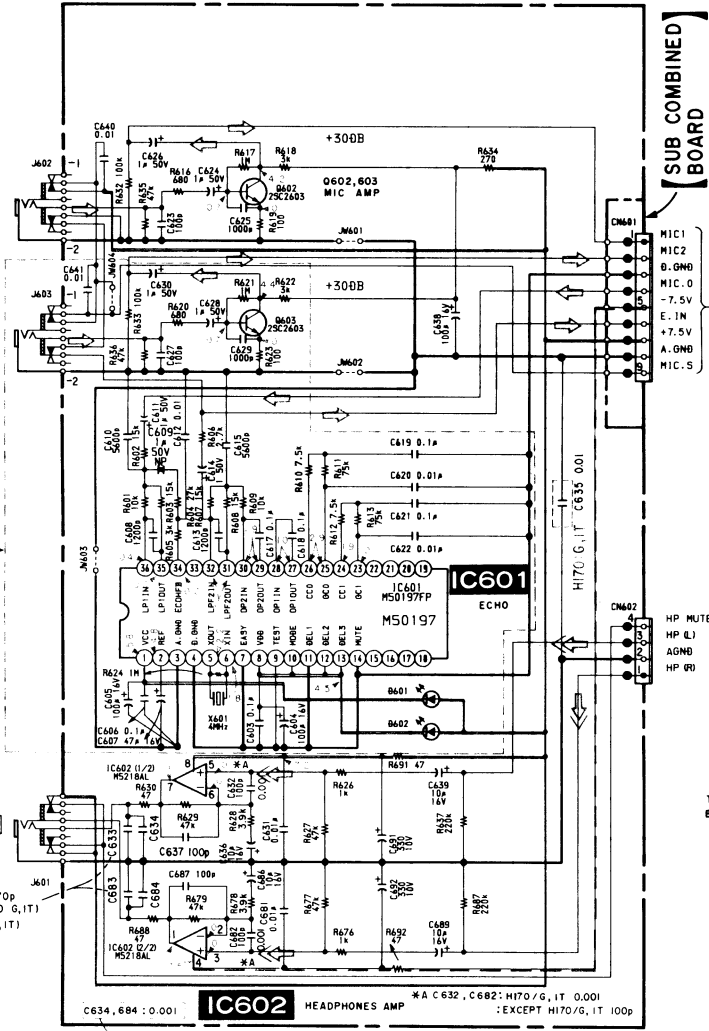

16



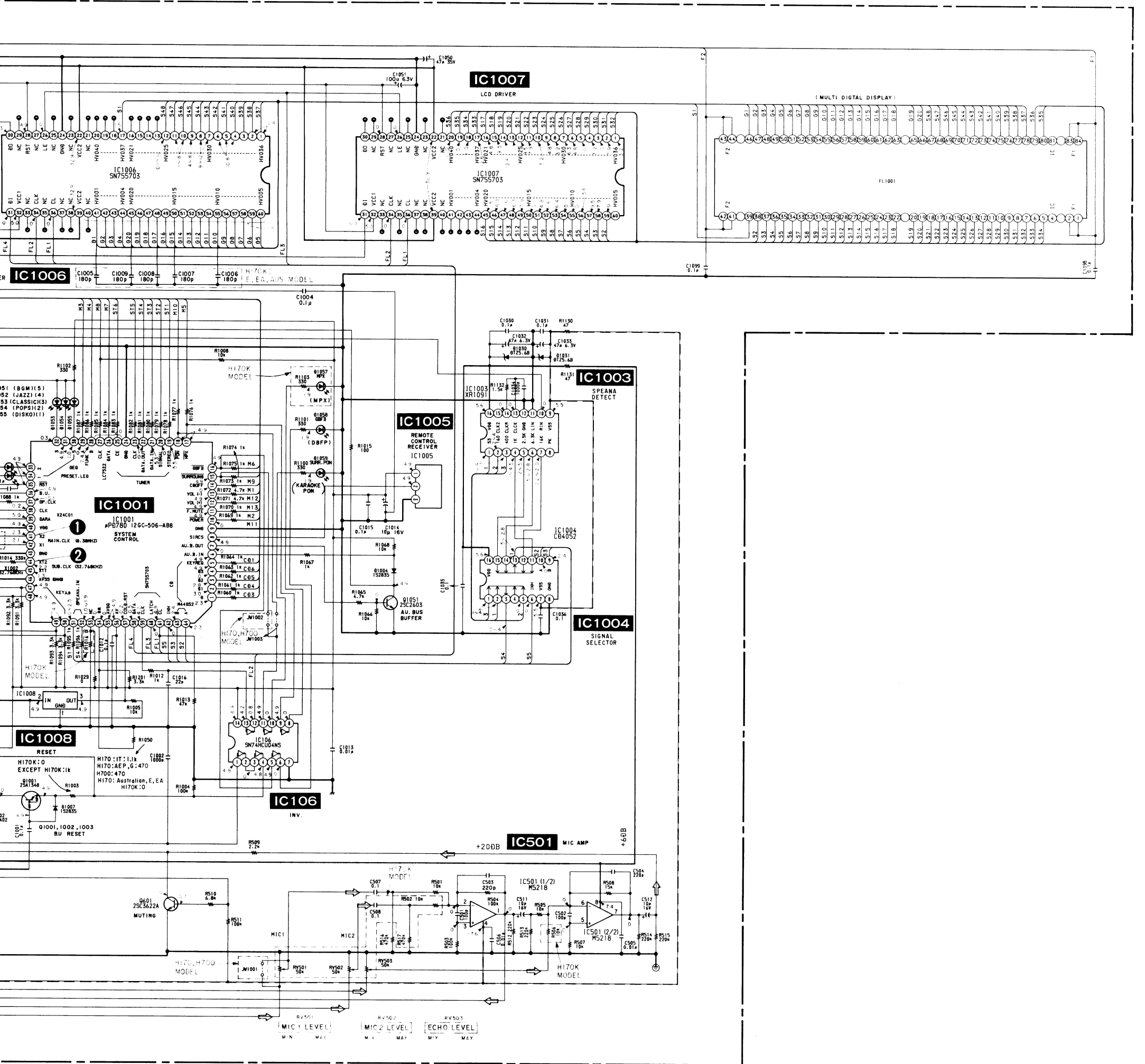

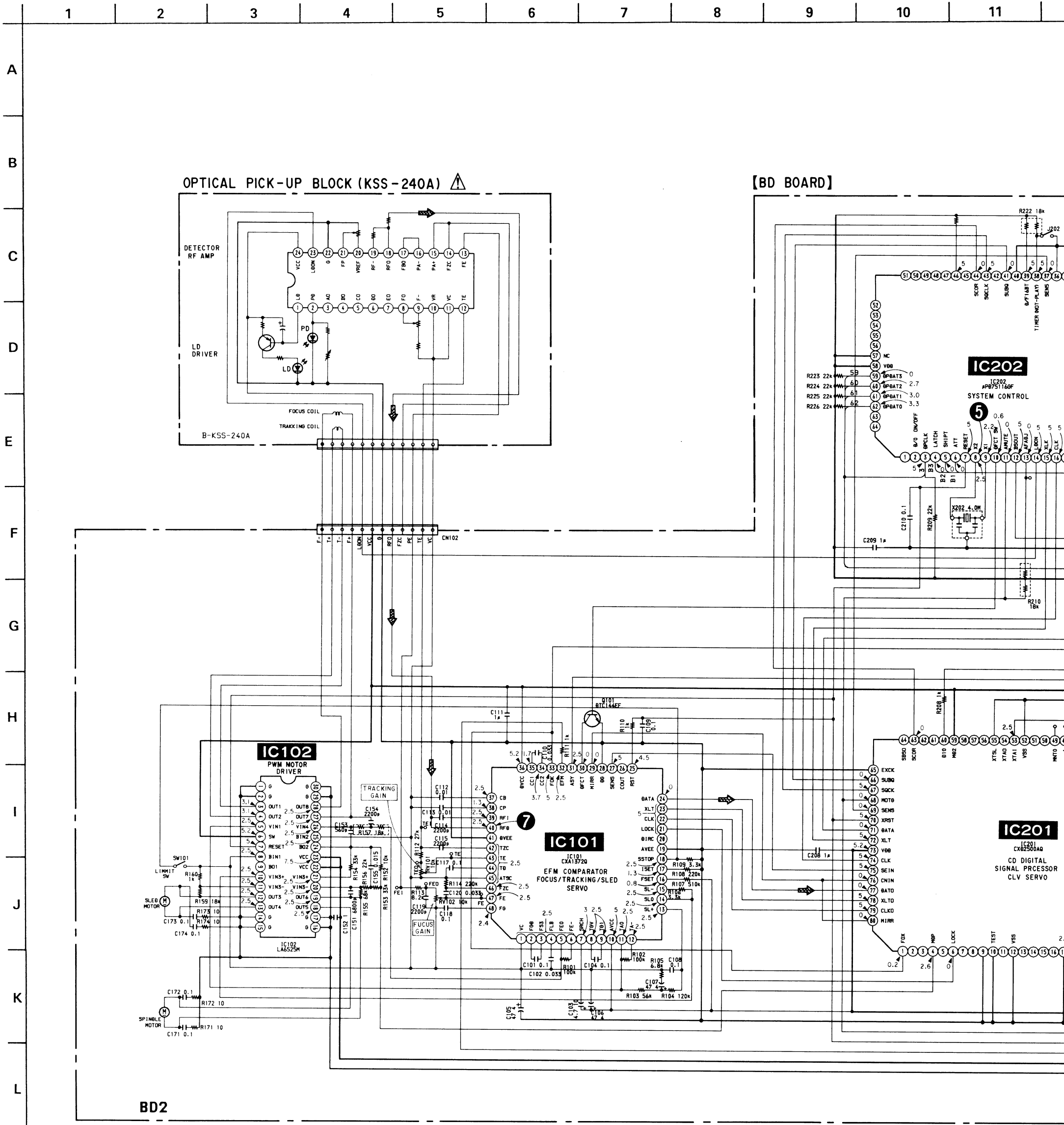

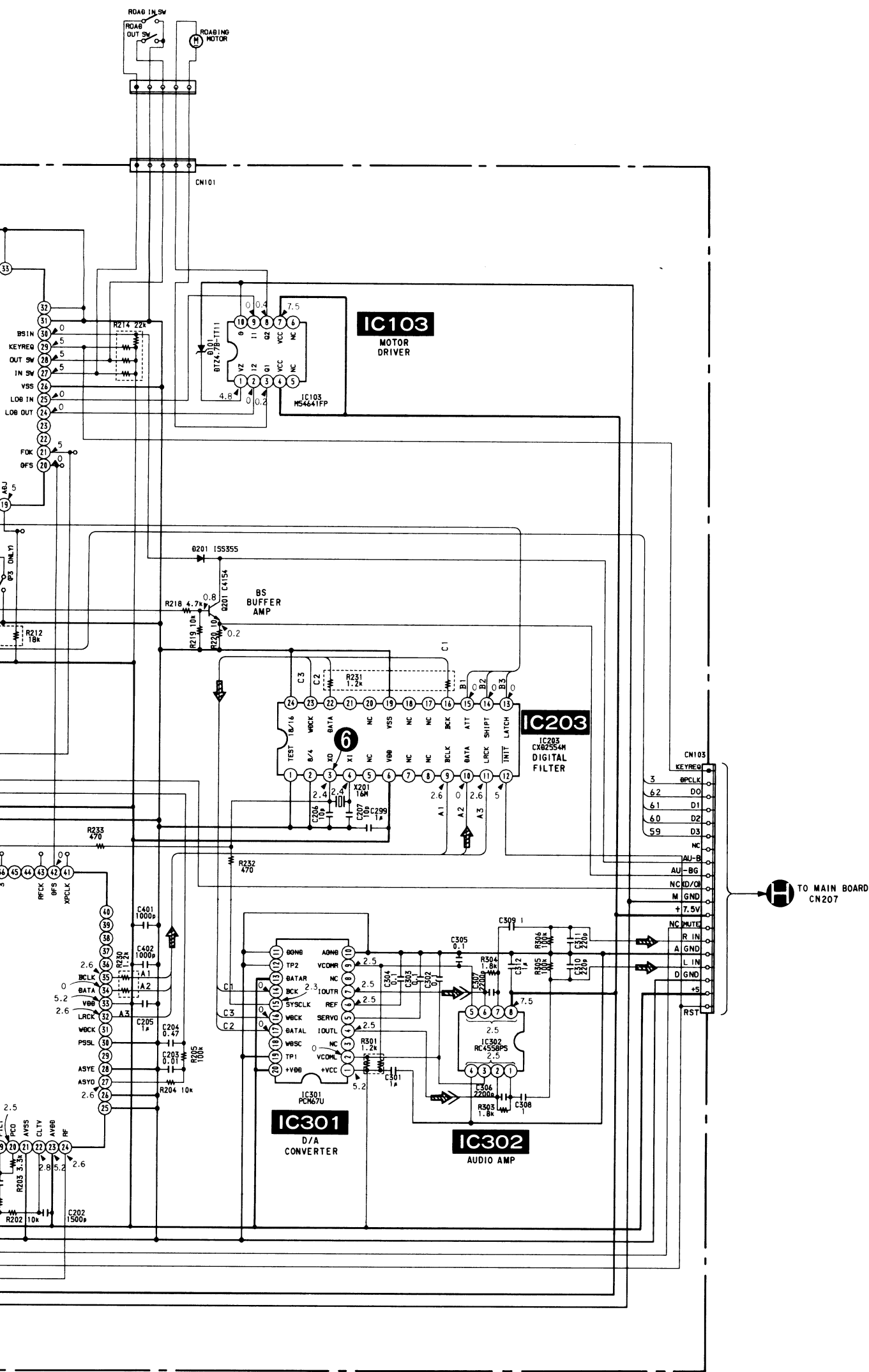

• Wave forms

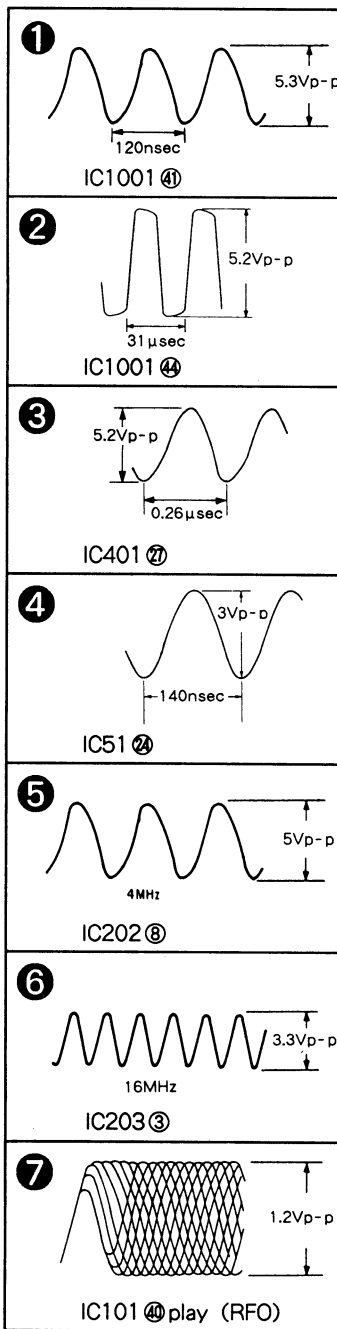

Note on Schematic Diagram :

- All capacitors are in  $\mu\text{F}$  unless otherwise noted.  $\text{pF}$ :  $\mu\text{pF}$  50WV or less are not indicated except for electrolytics and tantalums.
- All resistors are in  $\Omega$  and  $\frac{1}{4}$  W or less unless otherwise specified.
- $\Delta$  : internal component.
- $\text{---}$  : fusible resistor.

Note :The components identified by mark  $\Delta$  or dotted line with mark  $\Delta$  are critical for safety. Replace only with part number specified.

- $\text{---}$  : B + Line.
- $\text{---}$  : B - Line.
- $\text{---}$  : adjustment for repair.
- Voltage and waveforms are dc with respect to ground under no-signal conditions. no mark : PB
- Voltages are taken with a VOM (input impedance 10 M $\Omega$ ). Voltage variations may be noted due to normal production tolerances.
- Waveforms are taken with a oscilloscope. Voltage variations may be noted due to normal production tolerances.
- Circled numbers refer to waveforms.
- Signal path.
  - $\rightarrow$  : FM  $\text{---}$  : PB  $\text{---}$  : CD
  - $\text{---}$  : REC  $\text{---}$  : CD AF
  - $\text{---}$  : AF
  - $\text{---}$  : MIC
- EE : East European
- G : Germany
- IT : Italian

Note on Mounting Diagram :

- $\text{---}$  : Parts extracted from the component side.
- $\bullet$  : Through hole.
- $\text{---}$  : Pattern on the side which is seen.
- $\text{---}$  : Pattern of the rear side.

• IC Block Diagrams

• IC201 CXD2500AQ

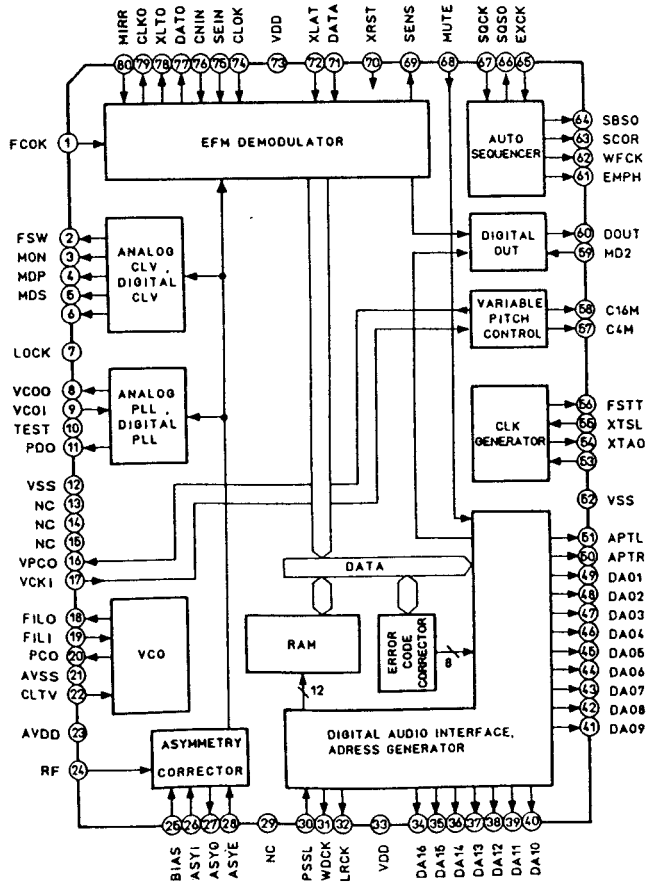

• IC102 LA6525M

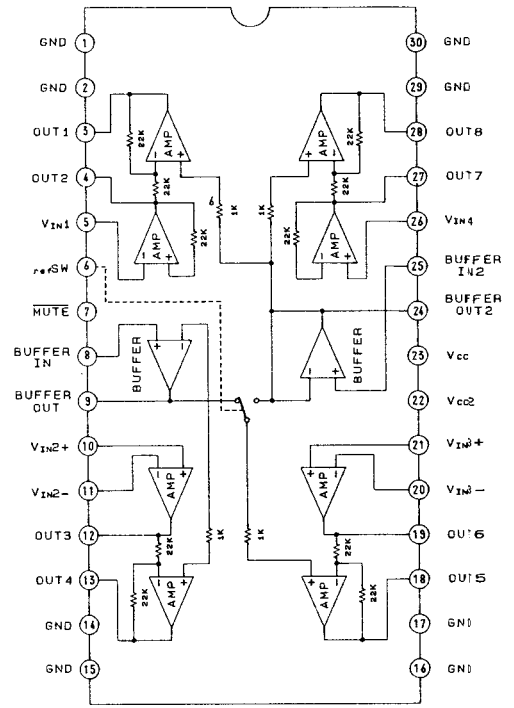

• IC203 CXD2554M

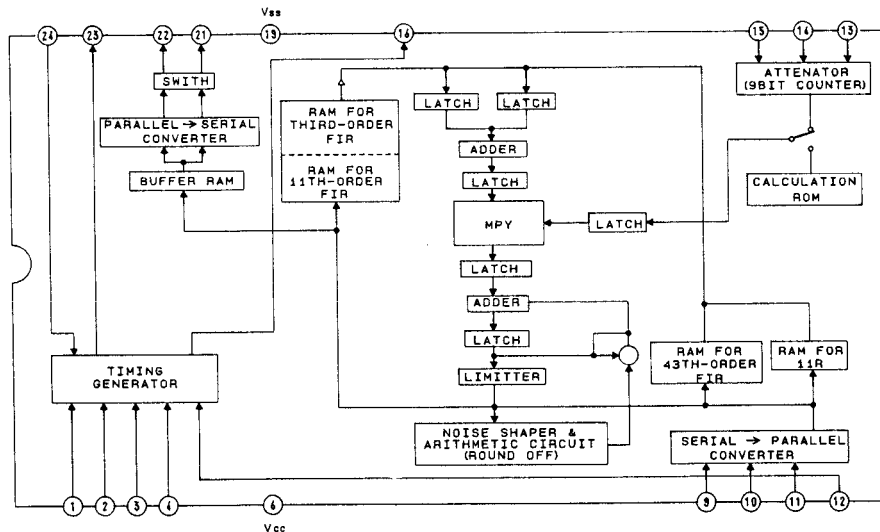

· IC101 CXA1372AQ

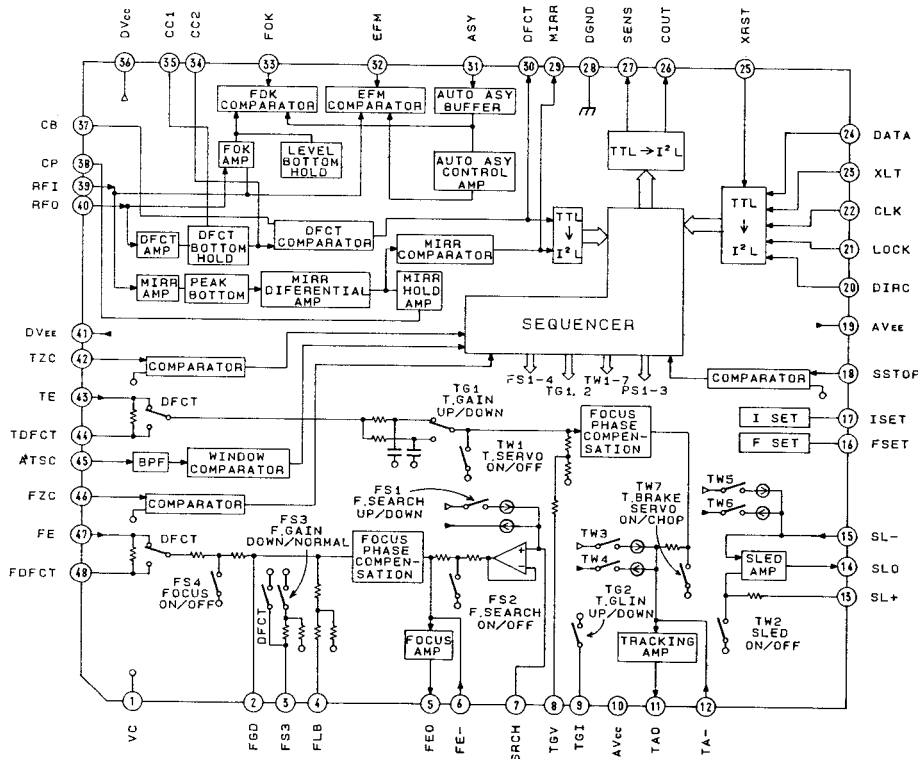

· IC103 M54641FP

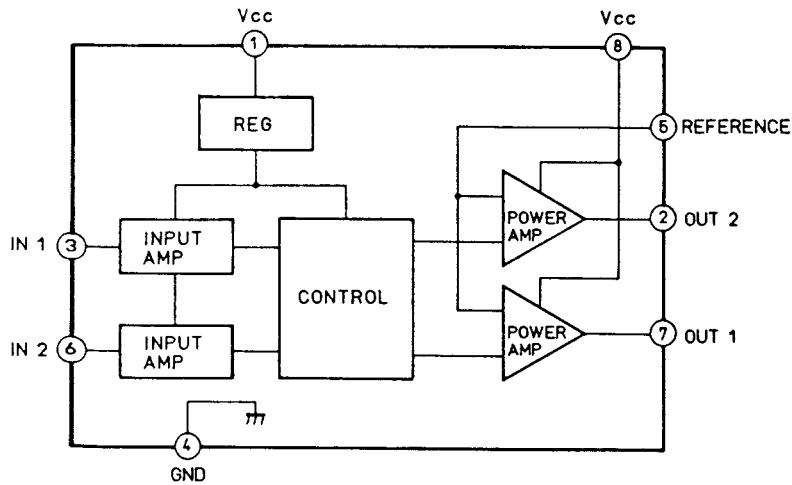

## 6- 10. IC PIN DESCRIPTION

## ● IC401 Deck Controller (M50946- 251FP)

Pin No.	Pin Name	I/O	Symbol	Description																																				
1	P62		G	GND																																				
2	P61		G	GND																																				
3	P60		G	GND																																				
4	P47		G	GND																																				
5	P46		G	GND																																				
6	AN5	I	B HALF	Deck B record prevention claw A, B detection input (Analog) <table border="1"> <thead> <tr> <th>Volgate (V)</th> <th>1V</th> <th>1.9V</th> <th>2.8V</th> <th>3.9V</th> <th>5V</th> </tr> </thead> <tbody> <tr> <td>Harf</td> <td>ON</td> <td>ON</td> <td>ON</td> <td>ON</td> <td>OFF</td> </tr> <tr> <td>E. PROOF A</td> <td>OFF</td> <td>ON</td> <td>OFF</td> <td>ON</td> <td>OFF</td> </tr> <tr> <td>E. PROOF B</td> <td>ON</td> <td>ON</td> <td>OFF</td> <td>OFF</td> <td>OFF</td> </tr> </tbody> </table>	Volgate (V)	1V	1.9V	2.8V	3.9V	5V	Harf	ON	ON	ON	ON	OFF	E. PROOF A	OFF	ON	OFF	ON	OFF	E. PROOF B	ON	ON	OFF	OFF	OFF												
Volgate (V)	1V	1.9V	2.8V	3.9V	5V																																			
Harf	ON	ON	ON	ON	OFF																																			
E. PROOF A	OFF	ON	OFF	ON	OFF																																			
E. PROOF B	ON	ON	OFF	OFF	OFF																																			
7	AN4	I	KEY Y	KEY input <table border="1"> <thead> <tr> <th>Volgate (V)</th> <th>0</th> <th>0.3</th> <th>0.7</th> <th>1.2</th> <th>1.7</th> <th>2.3</th> <th>2.8</th> <th>3.4</th> <th>4.0</th> <th>4.5</th> <th>5.0</th> </tr> </thead> <tbody> <tr> <td>KEY Y</td> <td>B■</td> <td>B■</td> <td>B▶</td> <td>B◀</td> <td></td> <td>A◀◀</td> <td>A▶▶</td> <td></td> <td></td> <td>RELAY</td> <td>OFF</td> </tr> <tr> <td>KEY X</td> <td>A■</td> <td>A▶</td> <td>A◀</td> <td>A◀</td> <td>B◀◀</td> <td>B●</td> <td>B</td> <td>CD</td> <td></td> <td></td> <td></td> </tr> </tbody> </table>	Volgate (V)	0	0.3	0.7	1.2	1.7	2.3	2.8	3.4	4.0	4.5	5.0	KEY Y	B■	B■	B▶	B◀		A◀◀	A▶▶			RELAY	OFF	KEY X	A■	A▶	A◀	A◀	B◀◀	B●	B	CD			
Volgate (V)	0	0.3	0.7		1.2	1.7	2.3	2.8	3.4	4.0	4.5	5.0																												
KEY Y	B■	B■	B▶	B◀		A◀◀	A▶▶			RELAY	OFF																													
KEY X	A■	A▶	A◀	A◀	B◀◀	B●	B	CD																																
8	AN3	I	KEY X																																					
9	AN2	I	AMS IN	AMS signal input																																				
10	P41	O	L MUTE	Line mute output																																				
11	P40	O	R MUTE	mute output																																				
12	P37	O	RELAY (B MD)	REC/PB change relay output																																				
13	P36	O	R/P	Dolby IC REC/PB select output																																				
14	P35	O	EQ70	Playback EQ output for playing deck																																				
15	P34	O	SEL A/B	Dolby IC PB input Deck A/B select output																																				
16	P33	O	AMS A/B	AMS AMP input Deck A/B select output																																				
17	P32	I	AU BUS	AUDIO BUS input																																				
18	P31	O	BIAS	Bias oscillation output																																				
19	P30	O	AUB OUT	AUDIO BUS output																																				
20	INT1	I	A UBUS	AUDIO BUS normal input																																				
21	NC	—	—	—																																				
22	NC	—	—	—																																				
23	NC	—	—	—																																				
24	CNVSS		CNVSS	GND																																				
25	RESET	I	RESET	Microcomputer reset input																																				
26	XIN	I	XIN	Clock input (4MHz)																																				
27	Xo	O	Xo	Clock output (4MHz)																																				
28	Φ	O	Φ	Not used (open)																																				
29, 65	Vss		Vss	GND																																				
30	P57	I	PW IN	POWER OFF detection input																																				
31	P56	I	A STOP	Deck A STOP switch input																																				
32	P55	I	A HALF	Deck A Half switch input																																				
33	P54	I	A SHUT	Deck A Reel table signal input																																				
34	P53	I	A70 U	Deck A TYPE II switch input																																				
35	P52	I	B STOP	Deck B STOP switch input																																				
36	P51	I	B SHUT	Deck B Reel table signal input																																				
37	P50	I	B70 U	Deck B TYPE II switch input																																				
38	NC	—	—	—																																				
39	P17	O	ARM 3	Deck A Reel Motor control out																																				
40	P16	O	ARM 2	Deck A Reel Motor control out																																				

Pin No.	Pin Name	I/O	Symbol	Description
41	P15	O	ARM 1	Deck A Reel Motor control out
42	P14	O	BRM 3	Deck B Reel Motor control out
43	P13	O	BRM 2	Deck B Reel Motor control out
44	P12	O	BRM 1	Deck B Reel Motor control out
45	P11	O	H/L	Capstan motor speed select
46	P10	O	A CM	A Capstan motor ON/OFF
47	P07	O	B CM	B Capstan motor ON/OFF
48	P06	I	BS/ASCH	Deck A Reel table/BS signal input
49	P05	I	A · P/BSCH	Deck B Reel table/A · P signal input
50	P04	O	A ◁	Deck A RVS LED output
51	P03	O	A ▷	Deck A FWD LED output
52	P02	O	A PLAY	Deck B RVS/FWD LED control output
53	P01	O	DUB H	High Speed Dubbing LED output
54	P00	O	DUB N	Normal Speed Dubbing LED output
55	NC	—	—	—
56	P27	O	CD SYNC	Auto CD Synchro LED output
57	P26	O	B ◁	Deck B RVS LED output
58	P25	O	B ▷	Deck B FWD LED output
59	O24	O	B PLAY	Deck B RVS/FWD LED control output
60	P23	O	B PAUSE	Deck B PAUSE LED output
61	P22	O	B ●	Auto CD Synchro LED output
62	P21	O	PASS	PASS amplifier switch output
63	P20	I	TEST	Electrical adjustment test mode setting
64	NC	—	—	—
66	NC	—	—	—
67	Vcc		Vcc	POWER 5 ± 0.5V
68	AVss		AVss	Analog system GND
69	VREF	I	VREF	Analog system reference voltage input
70	D · A		D · A	GND
71	PWM		—	GND
72	P63		—	GND

**[TEST MODE]**

When making pin ③ low (connect TP1 to ground with jumper wire), following function operates.

1. Sourec monitor

Release the line mute while recording.

● IC202 CD Controller (  $\mu$ PD75116GF)

Pin No.	Pin Name	I/O	Description
1	Not Used	O	OPEN
2	Not Used	O	OPEN
3	DPCLK	O	Display data transmission clock output
4	LATCH	O	Serial data latch pulse output for digital filter CXD2554M
5	SHIPT	O	Serial clock output for digital filter CXD2554M
6	AFT	O	Serial clock output for digital filter CXD2554M
7	RESET	I	System reset input terminal (LOW ACTIVE)
8	X2	I	System clock input 4.0MHZ
9	X1	I	System clock input 4.0MHz
10	DFCTSW	O	For focus in till spindle kick is ON except then is OFF.
11	AMUTE	O	Muting ON/OFF output
12	BSOUT	O	Audio bus output
13	AFADJ	I	Teast mode input, and on time POWER "L" is test move ment of every kind
14	LDON	O	Laser diode ON/OFF output
15	XKT	O	Serial data latch pulse output for CXD2500AQ
16	CLK	O	Serial data output for CXD2500AQ
17	DATA	O	Serial data output for CXD2500AQ
18	Not Used	I	GND
19	ADJ	I	Test mode input, "L" is GFS no check.
20	GFS	I	GFS OK/NO Good input
21	FOK	I	Focus OK/NO Good input
22	Not Used	O	OPEN
23	Not Used	O	OPEN
24	LODOUT	O	Disc tray loading-out output
25	LODIN	O	Disc tray loading-out output
26	VSS	I	GND
27	INSW	I	Disk tray clamp-end input
28	OUTSW	I	Disk tray open-end input
29	(TIMER)	I	Timer start input
30	BSIN	I	Audio bus input
31	Not Used	I	GND
32	Not Used	I	GND
33	Not Used	I	GND
34	Not Used	I	GND
35	Not Used	I	GND
36	Not Used	I	GND
37	SENS	I	SENS input, and the state input of every kind from CXD2500Q
38	TIMER	I	(NOT-PLAY)
39	D/F 16BT	I	(NOT-PLAY)
40	Not Used	I	GND
41	SUBQ	I	Q data serial input from CXD2500AQ
42	Not Used	O	OPEN
43	SQCLK	O	Sub-code Q data read-in clock output for CXD2500AQ
44	SCOR	I	Sub-code synchro S0 and S1 detect input
45	Not Used	O	OPEN
46		O	
47	Not Used	O	OPEN
48	Not Used	O	OPEN
49	Not Used	I	OPEN
50	Not Used	I	OPEN



Pin No.	Pin Name	I/O	Description
51	Not Used	I	OPEN
52	Not Used	I	OPEN
53	Not Used	O	OPEN
54	Not Used	O	OPEN
55	Not Used	O	OPEN
56	Not Used	O	OPEN
57	Not Used	I	+ 5V
58	VDD	I	+ 5V
59	DPDAT3	O	OPEN
60	DPDAT2	O	OPEN
61	DPDAT1	O	OPEN
62	DPDAT0	O	OPEN

## SECTION 7 EXPLODED VIEWS

**NOTE:**

- -XX, -X mean standardized parts, so they may have some differences from the original one.
- Color Indication of Appearance Parts  
Example :  
KNOB, BALANCE (WHITE)...(RED)  
                  ↑                  ↑  
Parts color    Cabinet's color

- Items marked "\*" are not stocked since they are seldom required for routine service. Some delay should be anticipated when ordering these items.
- The mechanical parts with no reference number in the exploded views are not supplied.
- Hardware (# mark) list is given in the last of this parts list.

The components identified by mark  $\triangle$  or dotted line with mark  $\triangle$  are critical for safety. Replace only with part number specified.

- EA : Saudi Arabia
- AUS : Australian
- EE : East European
- G : Germany
- IT : Italian

### 7-1. CASE, POWER SECTION

$\blacktriangle$  A : POWER board (See page 72)

$\bullet$  B : POWER TRANSFORMER board (See page 73)

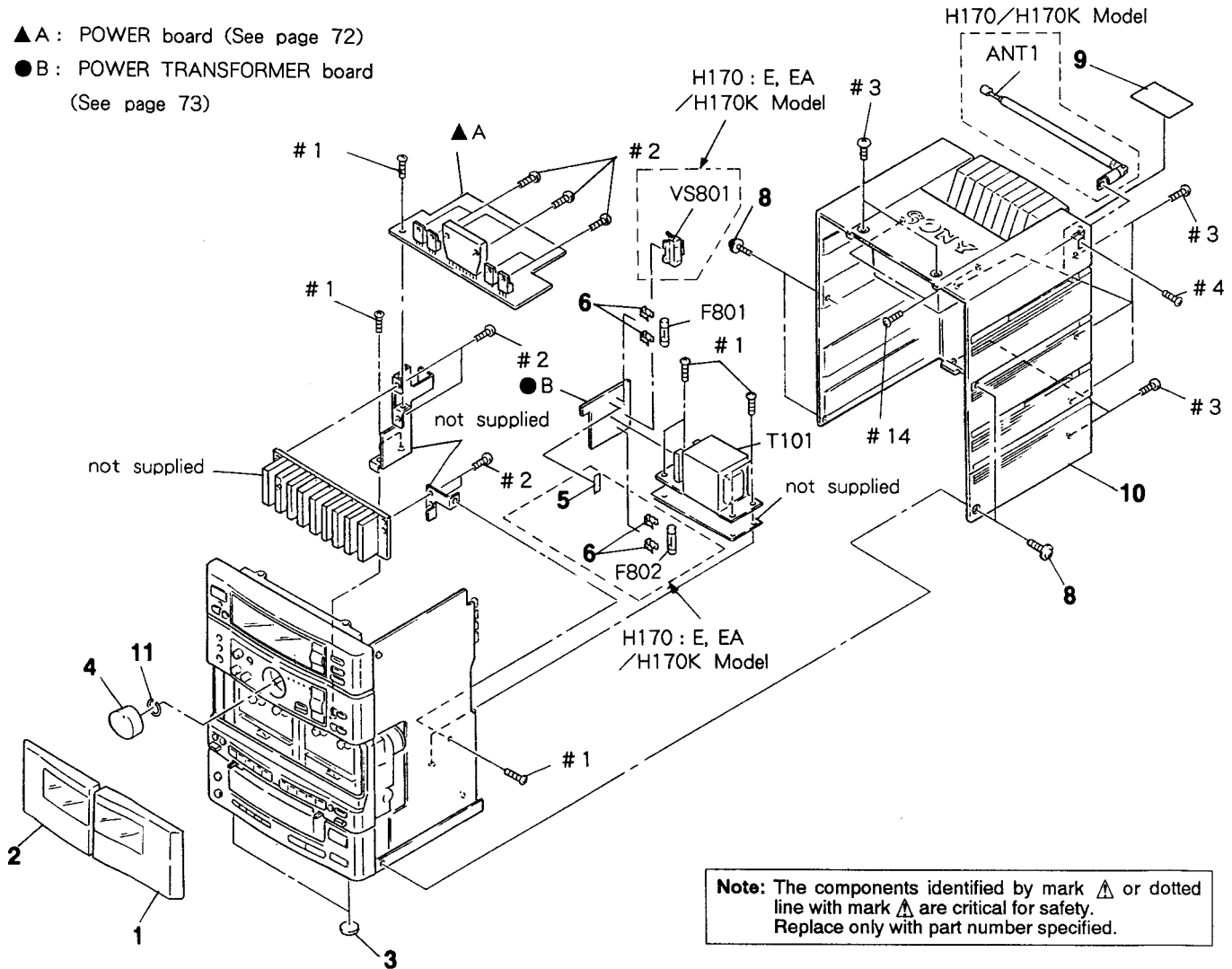

**Note:** The components identified by mark  $\triangle$  or dotted line with mark  $\triangle$  are critical for safety. Replace only with part number specified.

Ref. No.	Part No.	Description	Remarks
1	X-4942-644-1	LID (B) ASSY, CASSETTE	
2	X-4942-643-1	LID (A) ASSY, CASSETTE	
3	3-319-288-01	FOOT	
4	X-4942-657-1	KNOB (VOLUME) ASSY	
5	3-701-947-14	LABEL (T2A), FUSE (H170:E, EA, H170K)	
* 6	1-533-213-31	HOLDER, FUSE	
8	3-704-366-01	SCREW (CASE) (M3X8)	
* 9	4-941-548-01	LABEL, CLASS 1 (H700:UK)	
10	4-951-989-01	CASE (H700)	
10	X-4942-649-1	CASE ASSY (H170:AEP, AUS, EE)	

Ref. No.	Part No.	Description	Remarks
10	X-4942-650-1	CASE ASSY (H170:E, EA, H170K)	
11	3-356-957-01	SPRING	
$\triangle$	VS801	1-572-675-11 SWITCH, POWER VOLTAGE CHANGE (H170:E, EA, H170)	
	ANT1	1-501-321-51 ANTENNA, TELESCOPIC (H170, H170K)	
$\triangle$	F801	1-532-078-00 FUSE (1A)	
$\triangle$	F801	1-532-203-00 FUSE (2A) (H170:E, EA, H170K)	
$\triangle$	F802	1-532-078-00 FUSE (1A) (H170:E, EA, H170K)	
$\triangle$	T101	1-450-769-11 TRANSFORMER, POWER (H170:AEP, G, IT, EE, H700)	
$\triangle$	T101	1-450-770-11 TRANSFORMER, POWER (H170:E, EA, AUS, H170K)	

7-2. FRONT PANEL, MAIN BOARD SECTION

- C: VOLUME board (See page 73)
- D: MIC HP board (See page 73)
- E: SW board (See page 73)

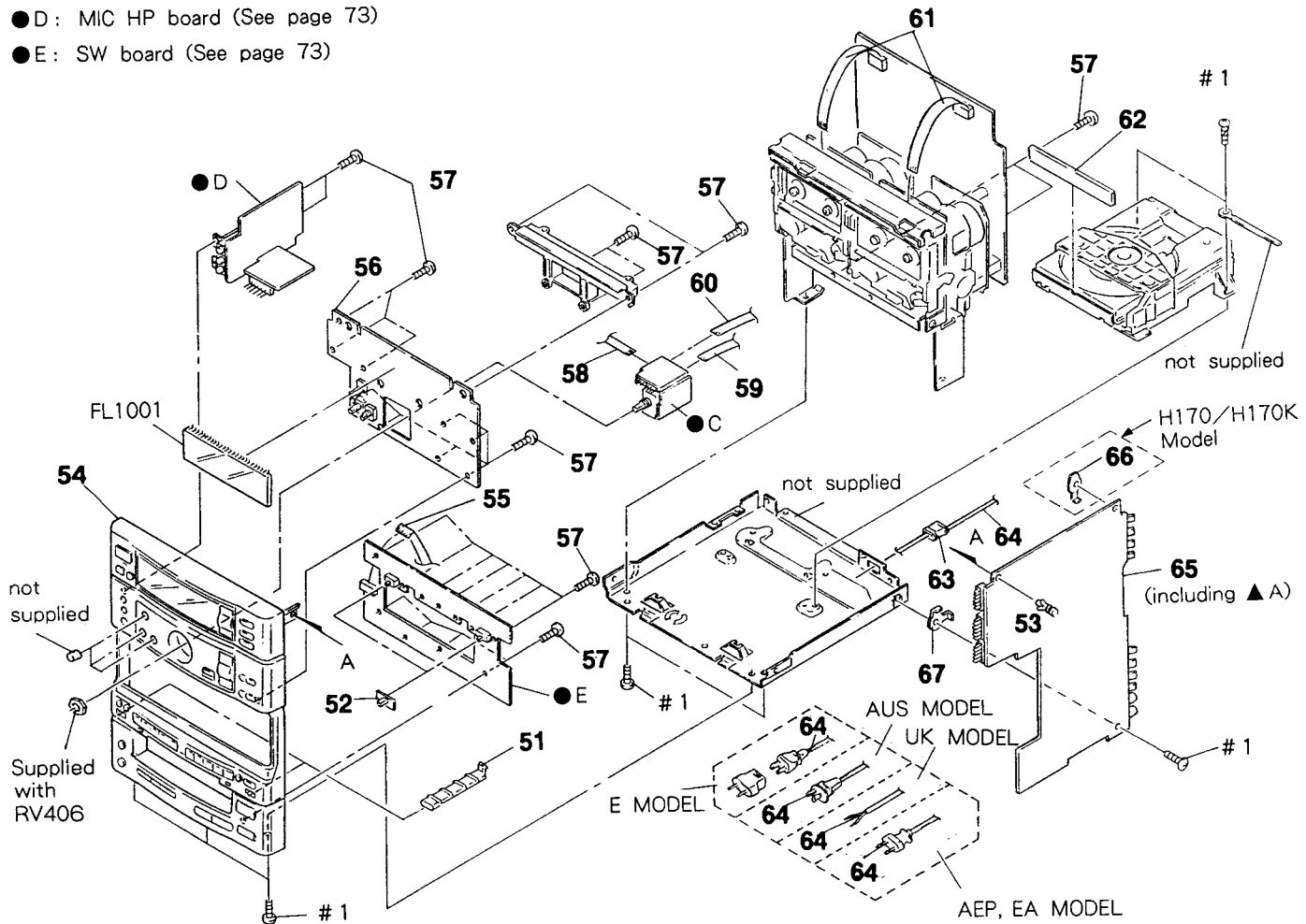

Ref. No.	Part No.	Description	Remarks	Ref. No.	Part No.	Description	Remarks
51	4-951-982-01	BUTTON (TC-E)		62	4-951-984-01	PANEL (LOADING)	
52	4-951-985-01	KNOB (SLIDE)		* 63	3-703-244-00	BUSHING (2104), CORD (H170:AEP, EE, H700)	
53	4-812-134-00	RIVET NYLON, 3.5		* 63	3-703-571-11	BUSHING (S) (4516), CORD (H170:E, EA, AUS, H170K)	
54	X-4942-645-1	PANEL ASSY, FRONT (H170K)		△64	1-574-804-11	CORD, POWER (H700:UK)	
54	X-4942-646-1	PANEL ASSY, FRONT (H170:E, EA, AUS)		△64	1-574-805-11	CORD, POWER (H170:AEP, EA/H170K:EA/H700:AEP)	
54	X-4942-647-1	PANEL ASSY, FRONT (H170:AEP, EE)		△64	1-574-902-11	CORD, POWER (H170:E/H170K:E)	
54	X-4942-648-1	PANEL ASSY, FRONT (H700)		△64	1-590-042-11	CORD, POWER (WITH CORE) (H170:Germany, Italian)	
55	1-690-854-21	WIRE (FLAT TYPE) (16 CORE) (EXCEPT H700:UK)		△64	1-690-056-11	CORD, POWER (H170:AUS)	
55	1-690-854-31	WIRE (FLAT TYPE) (16 CORE) (H700:UK)		△64	1-696-169-11	CORD, POWER (H170:EE)	
* 56	A-4347-469-A	DISPLAY BOARD, COMPLETE (H170:E, EA)		* 65	A-4343-548-A	MAIN BOARD, COMPLETE (H170:E, EA)	
* 56	A-4347-475-A	DISPLAY BOARD, COMPLETE (H170:AEP, H700)		* 65	A-4343-553-A	MAIN BOARD, COMPLETE (H170K)	
* 56	A-4347-479-A	DISPLAY BOARD, COMPLETE (H170:Germany)		* 65	A-4343-554-A	MAIN BOARD, COMPLETE (H170:AEP)	
* 56	A-4347-480-A	DISPLAY BOARD, COMPLETE (H170:Italian)		* 65	A-4343-555-A	MAIN BOARD, COMPLETE (H170:Germany, Italian)	
* 56	A-4347-483-A	DISPLAY BOARD, COMPLETE (H170K)		* 65	A-4343-556-A	MAIN BOARD, COMPLETE (H700:EE)	
* 56	A-4347-490-A	DISPLAY BOARD, COMPLETE (H170:EE)		* 65	A-4343-558-A	MAIN BOARD, COMPLETE (H700)	
* 56	A-4347-544-A	DISPLAY BOARD, COMPLETE (H170:AUS)		* 65	A-4343-575-A	MAIN BOARD, COMPLETE (H170:AUS)	
57	4-951-620-01	SCREW, +BV (2.6X8) +BVTP		66	4-925-530-01	PLATE, GROUND (H170, H170K)	
58	1-690-996-11	WIRE (FLAT TYPE) (4 CORE)		67	4-942-204-01	PLATE, GROUND	
* 59	1-590-240-11	WIRE, FLAT TYPE (9 CORE)		FL1001	1-519-718-11	INDICATOR TUBE, FLUORESCENT	
60	1-690-997-11	CABLE, FLAT TYPE (11 CORE)					
61	1-690-588-31	WIRE, FLAT TYPE (9 CORE)					

**Note:** The components identified by mark  $\triangle$  or dotted line with mark  $\triangle$  are critical for safety. Replace only with part number specified.

7-3. MD CHASSIS SECTION

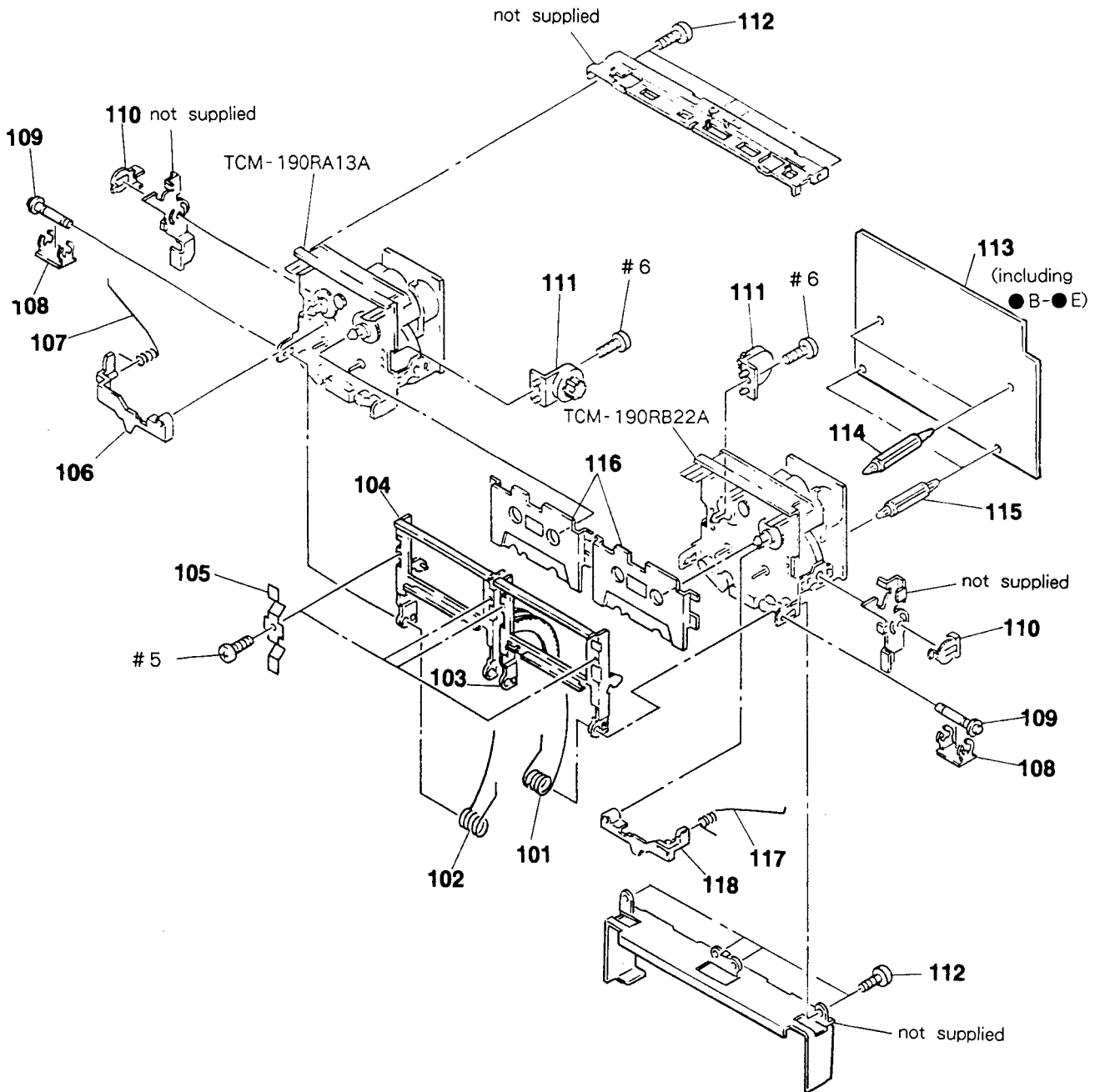

Ref. No.	Part No.	Description	Remarks	Ref. No.	Part No.	Description	Remarks
101	3-354-960-01	SPRING (LOADING R), TORSION		111	3-354-963-01	DAMPER	
102	3-354-959-01	SPRING (LOADING L), TORSION		112	4-951-620-01	SCREW, +BV (2.6X8) TAPPING	
103	X-3362-856-1	HOLDER (R) ASSY, CASSETTE		* 113	A-4343-549-A	SUB BOARD, COMPLETE (H170:E, EA)	
104	X-3362-857-1	HOLDER (L) ASSY, CASSETTE		* 113	A-4343-550-A	SUB BOARD, COMPLETE (H170:AEP, EE, H700)	
105	3-340-137-01	SPRING, CASSETTE RETAINER		* 113	A-4343-551-A	SUB BOARD, COMPLETE (H170:, IT)	
106	3-354-955-01	LEVER (EJ SAFTY LEVER L)		* 113	A-4343-552-A	SUB BOARD, COMPLETE (H170K)	
107	3-354-961-01	SPRING (EJ SAFTY SPRING L)		* 113	A-4343-573-A	SUB BOARD, COMPLETE (H170:AUS)	
108	3-367-720-01	RING (W), RETAINING		* 114	3-682-419-31	HOLDER, P. C. B	
109	3-367-721-01	SHAFT (FULCRUM SHAFT)		* 115	3-682-419-21	HOLDER, P. C. B	
110	3-354-957-01	JOINT (LOCK LEVER)		116	3-367-711-01	RETAINER, CASSETTE	
				117	3-354-962-01	SPRING (EJ SAFTY SPRING R)	
				118	3-354-956-01	LEVER (EJ SAFTY LEVER R)	

7-4. MECHANISM DECK SECTION (1)

( DECK A : TCM-190RA13A )  
 ( DECK B : TCM-190RB22A )

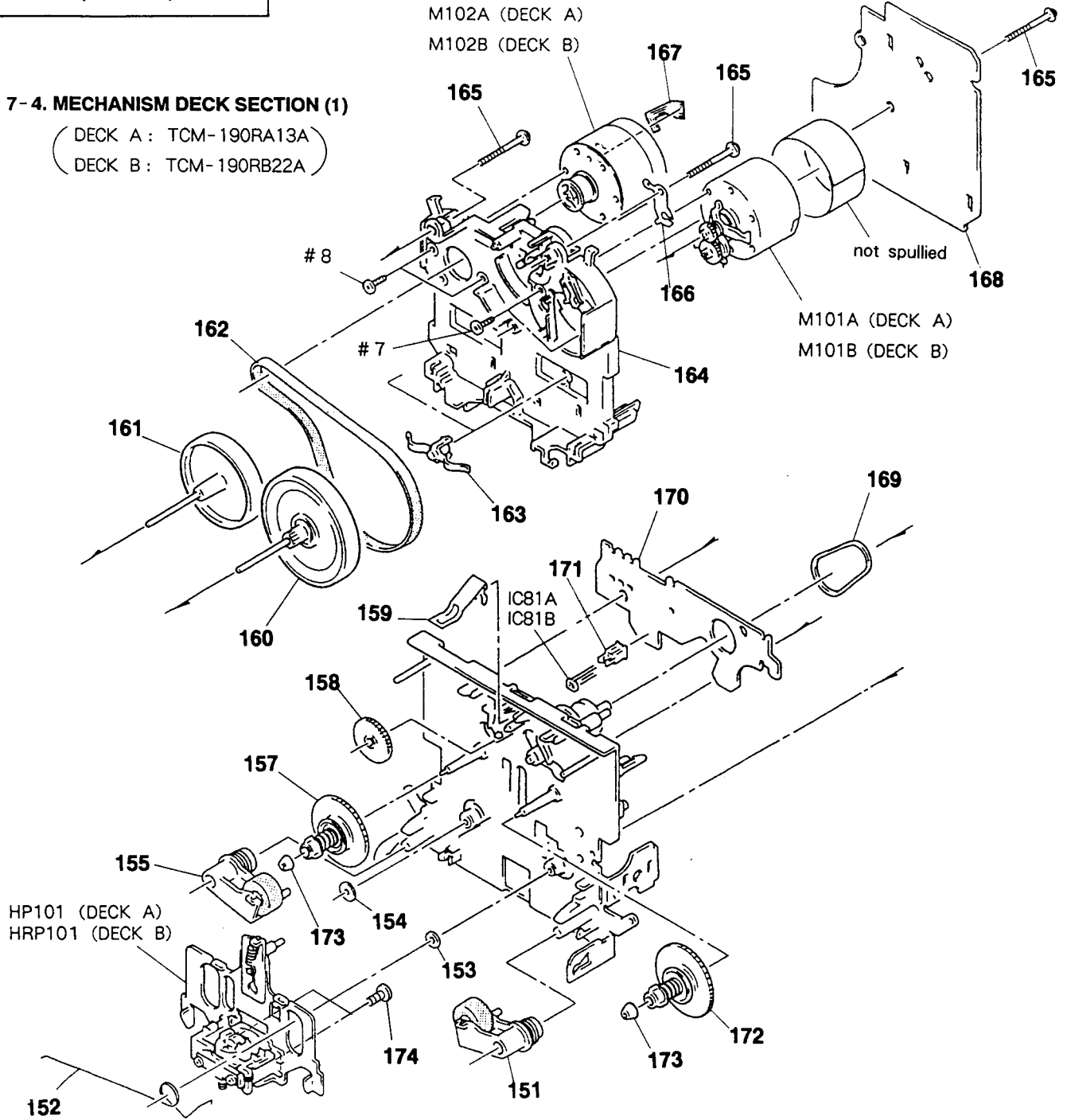

Ref. No.	Part No.	Description	Remarks	Ref. No.	Part No.	Description	Remarks
151	X-3359-408-1	LEVER (PINCH LEVER FWD) ASSY		* 168	A-2006-399-A	MD-A BOARD (RA13A), AUDIO	
152	3-359-455-01	SPRING, TORSION		* 168	A-2006-400-A	MD-B BOARD (RB22A), AUDIO	
153	3-356-713-01	WASHER		169	3-359-466-01	BELT (FR), SQUARE	
154	3-356-714-01	WASHER		* 170	1-634-841-14	LEAF SW (A)BOARD (RA13A) (DECK A)	
155	X-3359-409-1	LEVER (PINCH LEVER REV) ASSY		* 170	1-634-841-14	LEAF SW (B)BOARD (RB22A) (DECK B)	
157	X-3362-078-1	TABLE ASSY (B), REEL		171	3-343-419-01	HOLDER (S SENSOR A)	
158	3-359-424-01	GEAR (REV GEAR)		172	X-3359-404-1	TABLE ASSY, REEL	
159	3-359-430-01	SPRING(CASSETTE RETAINER), LEAF		173	3-362-308-01	CAP (REEL)	
160	X-3359-406-1	FLYWHEEL (FWD) ASSY		174	3-356-716-01	SCREW (2X4) (B TIGHT), +P	
161	X-3359-410-1	FLYWHEEL (REV) ASSY		HP101	A-2003-868-A	BASE ASSY, HEAD	
162	3-359-417-01	BELT (FLAT), CAPSTAN		HRP101	A-2003-838-A	BASE ASSY, HEAD	
163	3-575-321-00	RETAINER, THRUST, CAPSTAN		M101A	X-3363-501-1	MOTOR ASSY, REEL (DECK A)	
* 164	3-359-436-01	BASE (THRUST RETAINER), FITTING		M101B	X-3363-501-1	MOTOR ASSY, REEL (DECK B)	
165	3-359-414-01	SCREW (+PTPHW 2X23)		M102A	X-3359-417-1	MOTOR (CAPSTAN MOTOR) ASSY (DECK A)	
166	3-359-450-01	PLATE, GROUND		M102B	X-3359-417-1	MOTOR (CAPSTAN MOTOR) ASSY (DECK B)	
167	1-638-983-11	PC BOARD, MOTOR FLEXIBLE		IC81A	8-719-710-03	IC NJL5165K-B	
				IC81B	8-719-710-03	IC NJL5165K-B	

7-5. MECHANISM DECK SECTION (2)

(DECK A: TCM-190RA13A)  
(DECK B: TCM-190RB22A)

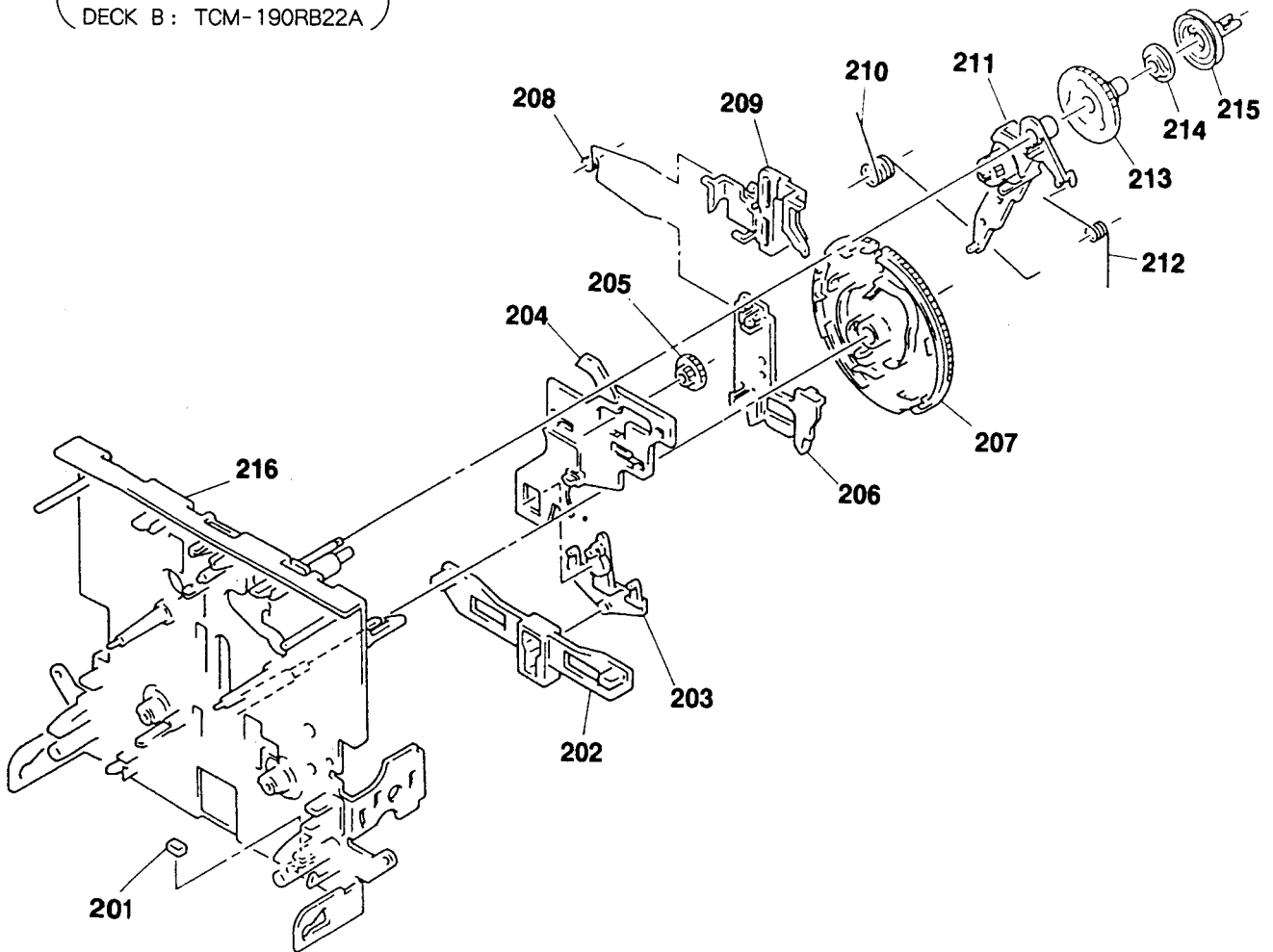

Ref. No.	Part No.	Description	Remarks	Ref. No.	Part No.	Description	Remarks
201	3-359-469-01	SPACER		210	3-359-456-01	SPRING (TRIGGER SPRING), TORSION	
* 202	3-359-425-01	SLIDER (REVERSE SLIDER)		211	X-3359-405-1	LEVER (FR ARM) ASSY	
203	3-359-426-01	LEVER (REVERSE LEVER)		212	3-359-453-01	SPRING (FR ARM), TORSION	
* 204	3-359-415-01	SLIDER (TRIGGER SLIDER)		213	3-359-419-01	GEAR (FR GEAR)	
205	3-359-448-01	GEAR (TRIGGER)		214	3-359-421-01	CLUTCH (REEL DISK)	
* 206	3-359-427-01	SLIDER (LEVERSE SLIDER)		215	3-359-418-01	PULLEY (FR PULLEY)	
207	3-359-420-01	GEAR (CAM GEAR)		216	X-3363-790-1	CHASSIS ASSY, MECHANICAL	
208	3-359-454-01	SPRING, TORSION					
209	3-359-429-01	SLIDER (BRAKE PLATE)					

7-6. CD SECTION (1)  
(CDM13B-5BD4A)

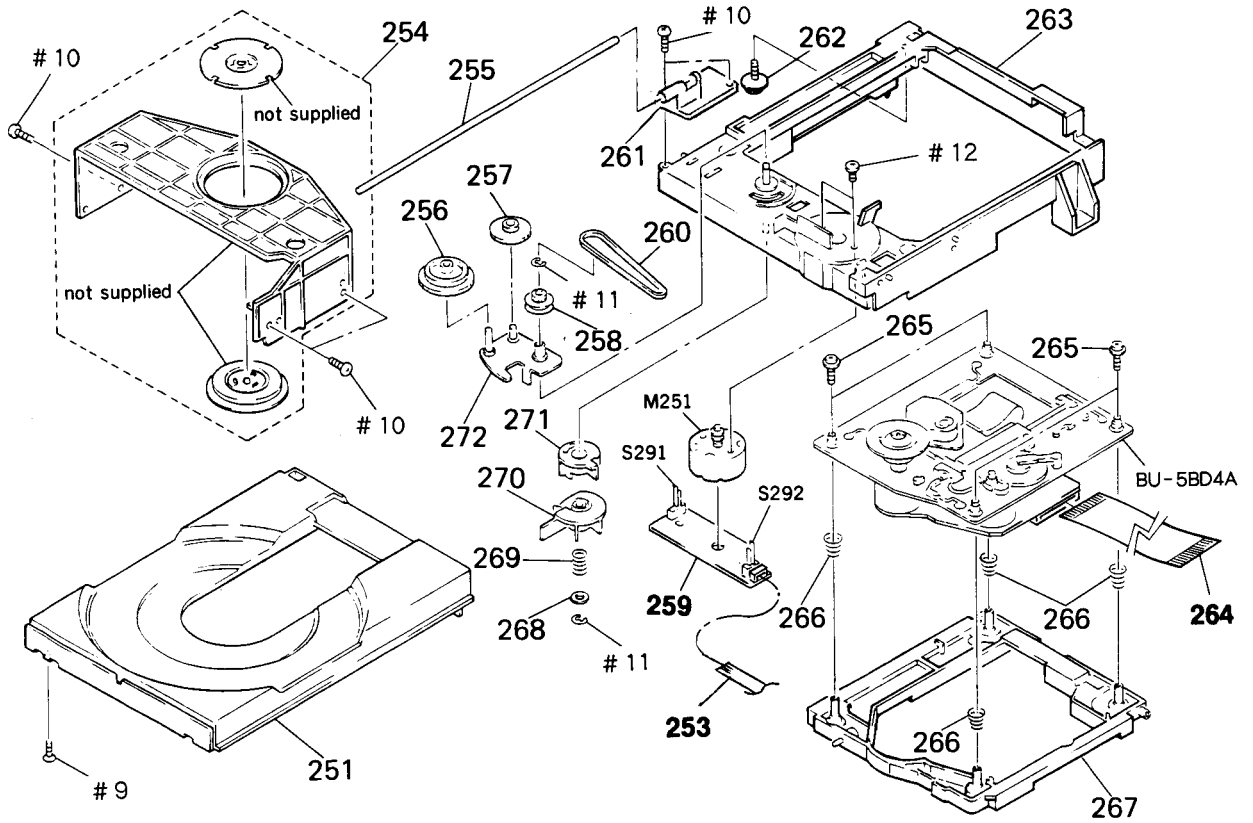

Ref. No.	Part No.	Description
251	4-944-012-01	TABLE, DISC
253	1-590-530-11	WIRE, FLAT TYPE
254	A-4604-752-A	HOLDER (MG) ASSY
255	4-929-764-01	SHAFT (TABLE GUIDE)
256	4-927-620-01	GEAR (P)
257	4-927-628-01	GEAR (C)
258	4-929-724-01	PULLEY (B)
* 259	1-638-308-11	LOADING BOARD
260	4-927-649-01	BELT
261	4-944-006-01	BEARING
* 262	4-917-583-21	BRACKET, YOKE
263	X-4941-462-1	CHASSIS (MD) ASSY

Remarks

Ref. No.	Part No.	Description
264	1-690-853-11	WIRE (FLAT TYPE) (19 CORE)
265	4-933-134-01	SCREW (+PTPWH M2. 6X6)
266	4-917-541-01	SPRING (B)
267	4-929-747-01	HOLDER (BU)
268	4-927-654-01	WASHER (LIMITER)
269	3-659-338-00	SPRING, COMPRESSION
270	4-929-729-01	CAM (B)
271	4-929-727-01	CAM (A)
272	X-4929-703-1	ARM ASSY, SWING
M251	A-4608-362-A	MOTOR (L) ASSY
S291	1-571-924-11	SWITCH, LEAF (LOAD OUT)
S292	1-571-924-11	SWITCH, LEAF (LOAD IN)

Remarks

7-7. CD SECTION (2)

(BU-5BD4A)

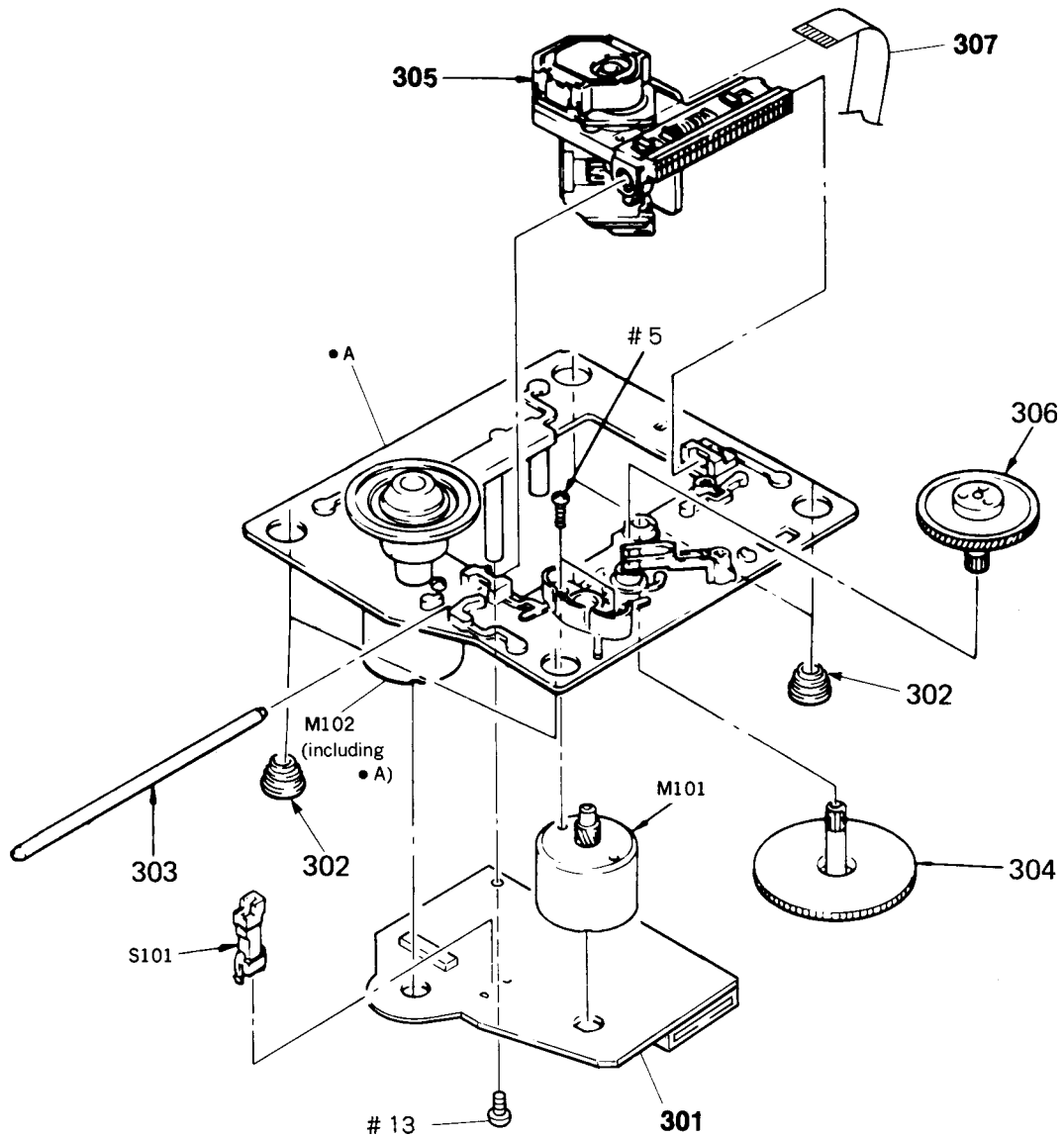

**Note:** The components identified by mark  $\triangle$  or dotted line with mark  $\triangle$  are critical for safety. Replace only with part number specified.

Ref. No.	Part No.	Description	Remarks	Ref. No.	Part No.	Description	Remarks
* 301	A-4617-936-A	BD BOARD, COMPLETE		306	4-917-567-01	GEAR (M)	
	302	4-933-126-01	INSULATOR (A)	307	1-575-001-11	WIRE, FLAT TYPE (12 CORE)	
	303	4-917-565-01	SHAFT, SLED	M101	X-4917-504-1	MOTOR ASSY (SLED)	
	304	4-917-564-01	GEAR (P), FLATNESS	M102	X-4917-523-3	MOTOR ASSY (SPINDLE)	
$\triangle$ 305	8-848-144-11	DEVICE, OPTICAL KSS-240A		S101	1-572-085-11	SWITCH, LEAF (LIMIT IN)	



BD

## SECTION 8 ELECTRICAL PARTS LIST

**NOTE:**

When indicating parts by reference number, please include the board name.

The components identified by mark  $\Delta$  or dotted line with mark  $\Delta$  are critical for safety. Replace only with part number specified.

- Due to standardization, replacements in the parts list may be different from the parts specified in the diagrams or the components used on the set.
- - XX, - X mean standardized parts, so they may have some difference from the original one.
- Items marked "\*" are not stocked since they are seldom required for routine service. Some delay should be anticipated when ordering these items.
- CAPACITORS :  
uF :  $\mu$ F
- RESISTORS  
All resistors are in ohms.  
METAL : metal-film resistor  
METAL OXIDE : Metal Oxide-film resistor  
F : nonflammable
- COILS  
uH :  $\mu$ H
- SEMICONDUCTORS  
In each case, u :  $\mu$ , for example :  
uA... :  $\mu$ A..., uPA...,  $\mu$ PA...,  
uPB...,  $\mu$ PB..., uPC...,  $\mu$ PC...,  
uPD...,  $\mu$ PD...
- EA : Saudi Arabia
- AUS : Australian
- EE : East European
- G : Germany
- IT : Italian

Ref. No.	Part No.	Description	Remarks	Ref. No.	Part No.	Description	Remarks
*	A-4617-936-A	BD BOARD					
		*****					
		< CAPACITOR >					
C101	1-163-038-00	CERAMIC CHIP 0.1uF	25V	C203	1-164-232-11	CERAMIC CHIP 0.01uF	50V
C102	1-163-989-11	CERAMIC CHIP 0.033uF	10% 25V	C204	1-164-005-11	CERAMIC CHIP 0.47uF	25V
C103	1-135-155-21	TANTALUM CHIP 4.7uF	10% 16V	C205	1-164-346-11	CERAMIC CHIP 1uF	16V
C104	1-163-038-00	CERAMIC CHIP 0.1uF	25V	C206	1-163-093-00	CERAMIC CHIP 10PF	5% 50V
C105	1-126-607-11	ELECT CHIP 47uF	20% 4V	C207	1-163-093-00	CERAMIC CHIP 10PF	5% 50V
C106	1-126-607-11	ELECT CHIP 47uF	20% 4V	C208	1-164-346-11	CERAMIC CHIP 1uF	16V
C107	1-126-607-11	ELECT CHIP 47uF	20% 4V	C209	1-164-346-11	CERAMIC CHIP 1uF	16V
C108	1-163-038-00	CERAMIC CHIP 0.1uF	25V	C210	1-163-038-00	CERAMIC CHIP 0.1uF	25V
C109	1-163-038-00	CERAMIC CHIP 0.1uF	25V	C299	1-164-346-11	CERAMIC CHIP 1uF	16V
C110	1-163-989-11	CERAMIC CHIP 0.033uF	10% 25V	C301	1-164-346-11	CERAMIC CHIP 1uF	16V
C111	1-164-346-11	CERAMIC CHIP 1uF	16V	C302	1-163-038-00	CERAMIC CHIP 0.1uF	25V
C112	1-164-232-11	CERAMIC CHIP 0.01uF	50V	C303	1-163-038-00	CERAMIC CHIP 0.1uF	25V
C113	1-164-232-11	CERAMIC CHIP 0.01uF	50V	C304	1-163-038-00	CERAMIC CHIP 0.1uF	25V
C114	1-164-695-11	CERAMIC CHIP 0.0022uF	5% 50V	C305	1-163-038-00	CERAMIC CHIP 0.1uF	25V
C115	1-164-695-11	CERAMIC CHIP 0.0022uF	5% 50V	C306	1-163-145-00	CERAMIC CHIP 0.0015uF	5% 50V
C117	1-163-038-00	CERAMIC CHIP 0.1uF	25V	C307	1-163-145-00	CERAMIC CHIP 0.0015uF	5% 50V
C118	1-163-038-00	CERAMIC CHIP 0.1uF	25V	C308	1-164-346-11	CERAMIC CHIP 1uF	16V
C119	1-164-695-11	CERAMIC CHIP 0.0022uF	5% 50V	C309	1-164-346-11	CERAMIC CHIP 1uF	16V
C120	1-163-989-11	CERAMIC CHIP 0.033uF	10% 25V	C310	1-163-125-00	CERAMIC CHIP 220PF	5% 50V
C151	1-163-019-00	CERAMIC CHIP 0.0068uF	10% 50V	C311	1-163-125-00	CERAMIC CHIP 220PF	5% 50V
C152	1-164-346-11	CERAMIC CHIP 1uF	16V	C312	1-164-346-11	CERAMIC CHIP 1uF	16V
C153	1-163-135-00	CERAMIC CHIP 560PF	5% 50V	C401	1-164-232-11	CERAMIC CHIP 0.01uF	50V
C154	1-164-695-11	CERAMIC CHIP 0.0022uF	5% 50V			< CONNECTOR >	
C155	1-163-023-00	CERAMIC CHIP 0.015uF	5% 50V	CN101	1-580-858-11	SOCKET, CONNECTOR (SMT) 5P	
C171	1-163-038-00	CERAMIC CHIP 0.1uF	25V	CN102	1-580-866-11	SOCKET, CONNECTOR (SMT) 12P	
C172	1-163-038-00	CERAMIC CHIP 0.1uF	25V	CN103	1-580-872-41	SOCKET, CONNECTOR (SMT) 19P	
C173	1-163-038-00	CERAMIC CHIP 0.1uF	25V			< DIODE >	
C174	1-163-038-00	CERAMIC CHIP 0.1uF	25V	D101	8-719-976-88	DIODE DTZ3.9B	
C201	1-163-809-11	CERAMIC CHIP 0.047uF	10% 25V	D201	8-719-988-62	DIODE 1SS355 (EXCEPT H170:EE)	
C202	1-163-145-00	CERAMIC CHIP 0.0015uF	5% 50V	D201	8-719-016-74	DIODE 1SS352 (H170:EE)	

BD	DISPLAY
----	---------

Ref. No.	Part No.	Description	Remarks
< IC >			
IC101	8-752-053-73 IC	CXA1372AQ	
IC102	8-759-823-48 IC	LA6525M	
IC103	8-759-636-20 IC	M54641FP	
IC201	8-752-337-26 IC	CXD2500AQ	
IC202	8-759-059-86 IC	uPD75116GF-F21-3BE	
IC203	8-752-337-10 IC	CXD2554M	
IC301	8-759-506-63 IC	PCM67U	
IC302	8-759-996-43 IC	RC4558PS-T1	
< TRANSISTOR >			
Q101	8-729-805-45 TRANSISTOR	2SC3395	
Q201	8-729-602-21 TRANSISTOR	2SC4154	
< RESISTOR >			
R101	1-216-097-00 METAL CHIP	100K 5% 1/10W	
R102	1-216-097-00 METAL CHIP	100K 5% 1/10W	
R103	1-216-091-00 METAL CHIP	56K 5% 1/10W	
R104	1-216-099-00 METAL CHIP	120K 5% 1/10W	
R105	1-216-069-00 METAL CHIP	6.8K 5% 1/10W	
R106	1-216-061-00 METAL CHIP	3.3K 5% 1/10W	
R107	1-216-114-00 METAL GLAZE	510K 5% 1/10W	
R108	1-216-105-00 METAL CHIP	220K 5% 1/10W	
R109	1-216-061-00 METAL CHIP	3.3K 5% 1/10W	
R110	1-216-049-00 METAL CHIP	1K 5% 1/10W	
R111	1-216-049-00 METAL CHIP	1K 5% 1/10W	
R112	1-216-083-00 METAL CHIP	27K 5% 1/10W	
R113	1-216-071-00 METAL CHIP	8.2K 5% 1/10W	
R114	1-216-105-00 METAL CHIP	220K 5% 1/10W	
R152	1-216-073-00 METAL CHIP	10K 5% 1/10W	
R153	1-216-085-00 METAL CHIP	33K 5% 1/10W	
R154	1-216-085-00 METAL CHIP	33K 5% 1/10W	
R155	1-216-093-00 METAL CHIP	68K 5% 1/10W	
R156	1-216-081-00 METAL CHIP	22K 5% 1/10W	
R157	1-236-427-11 NETWORK, RES	18K	
R159	1-216-079-00 METAL CHIP	18K 5% 1/10W	
R160	1-216-049-00 METAL CHIP	1K 5% 1/10W	
R171	1-216-001-00 METAL CHIP	10 5% 1/10W	
R172	1-216-001-00 METAL CHIP	10 5% 1/10W	
R173	1-216-001-00 METAL CHIP	10 5% 1/10W	
R174	1-216-001-00 METAL CHIP	10 5% 1/10W	
R201	1-216-061-00 METAL CHIP	3.3K 5% 1/10W	
R202	1-216-073-00 METAL CHIP	10K 5% 1/10W	
R203	1-216-061-00 METAL CHIP	3.3K 5% 1/10W	
R204	1-216-073-00 METAL CHIP	10K 5% 1/10W	
R205	1-216-097-00 METAL CHIP	100K 5% 1/10W	
R208	1-216-033-00 METAL CHIP	220 5% 1/10W	
R209	1-216-081-00 METAL CHIP	22K 5% 1/10W	
R210	1-236-427-11 NETWORK, RES	18K	
R212	1-236-427-11 NETWORK, RES	18K	

Ref. No.	Part No.	Description	Remarks
R214	1-239-039-11 NETWORK, RES	22K	
R218	1-216-065-00 METAL CHIP	4.7K 5% 1/10W	
R219	1-216-073-00 METAL CHIP	10K 5% 1/10W	
R220	1-216-001-00 METAL CHIP	10 5% 1/10W	
R222	1-236-427-11 NETWORK, RES	18K	
R223	1-216-081-00 METAL CHIP	22K 5% 1/10W	
R224	1-216-081-00 METAL CHIP	22K 5% 1/10W	
R225	1-216-081-00 METAL CHIP	22K 5% 1/10W	
R226	1-216-081-00 METAL CHIP	22K 5% 1/10W	
R230	1-236-413-11 NETWORK, RES	1.2K	
R231	1-236-413-11 NETWORK, RES	1.2K	
R232	1-216-041-00 METAL CHIP	470 5% 1/10W	
R233	1-216-041-00 METAL CHIP	470 5% 1/10W	
R301	1-236-413-11 NETWORK, RES	1.2K	
R303	1-216-055-00 METAL CHIP	1.8K 5% 1/10W	
R304	1-216-055-00 METAL CHIP	1.8K 5% 1/10W	
R305	1-216-097-00 METAL CHIP	100K 5% 1/10W	
R306	1-216-097-00 METAL CHIP	100K 5% 1/10W	
< VARIABLE RESISTOR >			
RV101	1-241-395-11 RES, ADJ, METAL GLAZE	10K	
RV102	1-241-395-11 RES, ADJ, METAL GLAZE	10K	
< SWITCH >			
SW101	1-572-085-11 SWITCH, LEAF (LIMIT IN)		
< VIBRATOR >			
X201	1-579-280-11 VIBRATOR, CRYSTAL	16MHz	
X202	1-579-216-11 VIBRATOR, CERAMIC	4MHz	
*****			
*	A-4347-469-A DISPLAY BOARD, COMPLETE (H170:E,EA)		
*****			
*	A-4347-475-A DISPLAY BOARD, COMPLETE (H170:AEP/H700)		
*****			
*	A-4347-479-A DISPLAY BOARD, COMPLETE (H170:IT)		
*****			
*	A-4347-480-A DISPLAY BOARD, COMPLETE (H170:G)		
*****			
*	A-4347-483-A DISPLAY BOARD, COMPLETE (H170K)		
*****			
*	A-4347-490-A DISPLAY BOARD, COMPLETE (H170:EE)		
*****			
*	A-4347-544-A DISPLAY BOARD, COMPLETE (H170:AUS)		
*****			
< CAPACITOR >			
C501	1-163-117-00 CERAMIC CHIP	100PF 5% 50V	
C502	1-163-117-00 CERAMIC CHIP	100PF 5% 50V	
C503	1-163-125-00 CERAMIC CHIP	220PF 5% 50V	
C504	1-163-125-00 CERAMIC CHIP	220PF 5% 50V	
C505	1-163-031-11 CERAMIC CHIP	0.01uF 50V	

## DISPLAY

Ref. No.	Part No.	Description	Remarks	Ref. No.	Part No.	Description	Remarks
C506	1-163-031-11	CERAMIC CHIP 0.01uF	50V	* CN1006	1-565-980-21	HOUSING, CONNECTOR(PC BOARD) 9P	
C507	1-163-038-00	CERAMIC CHIP 0.1uF	25V			< DIODE >	
C508	1-163-038-00	CERAMIC CHIP 0.1uF	25V(H170K)	D1001	8-719-820-05	DIODE 1SS181	
C511	1-126-157-11	ELECT 10uF	20% 16V	D1002	8-719-801-78	DIODE 1SS184	
C512	1-126-157-11	ELECT 10uF	20% 16V	D1003	8-719-820-05	DIODE 1SS181	
C1001	1-163-038-00	CERAMIC CHIP 0.1uF	25V	D1004	8-719-820-05	DIODE 1SS181	
C1002	1-163-025-11	CERAMIC CHIP 0.001uF	50V	D1005	8-719-820-05	DIODE 1SS181	
C1003	1-124-442-00	ELECT 330uF	20% 6.3V	D1007	8-719-820-05	DIODE 1SS181	
C1004	1-163-038-00	CERAMIC CHIP 0.1uF	25V	D1030	8-719-021-41	DIODE UZM5.6X	
C1005	1-162-956-11	CERAMIC CHIP 180PF	5% 50V (H170: E, EA, AUS/H170K)	D1031	8-719-021-41	DIODE UZM5.6X	
C1006	1-162-956-11	CERAMIC CHIP 180PF	5% 50V (H170: E, EA, AUS/H170K)	D1051	8-719-026-64	DIODE SML1260S	
C1007	1-162-956-11	CERAMIC CHIP 180PF	5% 50V (H170: E, EA, AUS/H170K)	D1052	8-719-026-64	DIODE SML1260S	
C1008	1-162-956-11	CERAMIC CHIP 180PF	5% 50V (H170: E, EA, AUS/H170K)	D1053	8-719-026-64	DIODE SML1260S	
C1009	1-162-956-11	CERAMIC CHIP 180PF	5% 50V (H170: E, EA, AUS/H170K)	D1054	8-719-026-64	DIODE SML1260S	
C1011	1-124-584-00	ELECT 100uF	20% 10V	D1055	8-719-026-64	DIODE SML1260S	
C1012	1-163-038-00	CERAMIC CHIP 0.1uF	25V	D1057	8-719-026-64	DIODE SML1260S (H170K)	
C1013	1-163-031-11	CERAMIC CHIP 0.01uF	50V	D1058	8-719-026-68	DIODE SML1960A	
C1014	1-126-157-11	ELECT 10uF	20% 16V	D1059	8-719-026-68	DIODE SML1960A	
C1015	1-163-038-00	CERAMIC CHIP 0.1uF	25V			< INDICATOR >	
C1016	1-163-235-11	CERAMIC CHIP 22PF	5% 50V	FL1001	1-519-718-11	INDICATOR TUBE, FLUORESCENT	
C1020	1-164-222-11	CERAMIC CHIP 0.22uF	25V			< IC >	
C1023	1-163-229-11	CERAMIC CHIP 12PF	5% 50V	IC106	8-759-927-29	IC SN74HC04ANS	
C1024	1-163-097-00	CERAMIC CHIP 15PF	5% 50V	IC501	8-759-996-43	IC RC4558PS	
C1025	1-163-038-00	CERAMIC CHIP 0.1uF	25V	IC1001	8-759-074-90	IC uPD78012GC-506-AB8	
C1026	1-126-177-11	ELECT 100uF	20% 10V	IC1002	8-759-500-31	IC X24C01P	
C1030	1-163-038-00	CERAMIC CHIP 0.1uF	25V	IC1003	8-759-991-11	IC XR1091DCP	
C1031	1-163-038-00	CERAMIC CHIP 0.1uF	25V	IC1004	8-759-516-41	IC CD4052BCM	
C1032	1-126-154-11	ELECT 47uF	20% 6.3V	IC1005	8-749-923-34	IC PHOTO DIODE GPIU59XB	
C1033	1-126-154-11	ELECT 47uF	20% 6.3V	IC1006	8-759-512-44	IC SN755703FT	
C1034	1-163-025-11	CERAMIC CHIP 0.001uF	50V	IC1007	8-759-512-44	IC SN755703FT	
C1035	1-163-038-00	CERAMIC CHIP 0.1uF	25V			< JUMPER RESISTOR >	
C1036	1-163-038-00	CERAMIC CHIP 0.1uF	25V	JW1001	1-216-295-00	METAL CHIP 0 5% 1/10W(H170/H700)	
C1041	1-163-038-00	CERAMIC CHIP 0.1uF	25V	JW1002	1-216-295-00	METAL CHIP 0 5% 1/10W(H170/H700)	
C1050	1-124-910-11	ELECT 47uF	20% 50V	JW1004	1-216-295-00	METAL CHIP 0 5% 1/10W(H170/H700)	
C1051	1-124-443-00	ELECT 100uF	20% 10V	JW1029	1-216-295-00	METAL CHIP 0 5% 1/10W(H170/H700)	
C1098	1-163-038-00	CERAMIC CHIP 0.1uF	25V			< TRANSISTOR >	
C1099	1-163-038-00	CERAMIC CHIP 0.1uF	25V	Q601	8-729-141-26	TRANSISTOR 2SC3622A-LK	
		< FILTER >		Q1001	8-729-900-61	TRANSISTOR DTA114ES	
CF1001	1-579-599-21	VIBRATOR, CERAMIC		Q1002	8-729-900-80	TRANSISTOR DTC114ES	
		< CONNECTOR >		Q1003	8-729-900-61	TRANSISTOR DTA114ES	
* CN1001	1-569-156-11	SOCKET, CONNECTOR 10P		Q1051	8-729-620-05	TRANSISTOR 2SC2603-EF	
* CN1002	1-569-156-11	SOCKET, CONNECTOR 10P				< RESISTOR >	
CN1003	1-695-027-11	PLUG, CONNECTOR 10P		R501	1-216-073-00	METAL CHIP 10K 5% 1/10W	
* CN1004	1-568-451-11	HOUSING, CONNECTOR(PC BOARD)10P		R502	1-216-073-00	METAL CHIP 10K 5% 1/10W(H170K)	



**DISPLAY**

**LEAF SW (A)**

**LEAF SW (B)**

**LOADING**

**MAIN (including POWER)**

Ref. No.	Part No.	Description	Remarks
		< SWITCH >	
S1001	1-572-184-11	SWITCH, KEYBOARD (POWER)	
S1002	1-572-184-11	SWITCH, KEYBOARD (TIMER)	
S1003	1-572-184-11	SWITCH, KEYBOARD (MPX) (H170K)	
S1009	1-572-184-11	SWITCH, KEYBOARD (+)	
S1010	1-572-184-11	SWITCH, KEYBOARD (BAND)	
S1011	1-572-184-11	SWITCH, KEYBOARD (-)	
S1012	1-572-184-11	SWITCH, KEYBOARD (FUNCTION)	
S1013	1-572-184-11	SWITCH, KEYBOARD (KARAOKE)	
S1014	1-572-184-11	SWITCH, KEYBOARD (PRESET)	
S1015	1-572-184-11	SWITCH, KEYBOARD (EQ)	
S1016	1-572-184-11	SWITCH, KEYBOARD (TIMER REC)	
S1017	1-572-184-11	SWITCH, KEYBOARD (MEMORY/NEXT)	
S1018	1-572-184-11	SWITCH, KEYBOARD (STEREO/MONO)	
S1019	1-572-184-11	SWITCH, KEYBOARD (+)	
S1020	1-572-184-11	SWITCH, KEYBOARD (-)	
S1021	1-572-184-11	SWITCH, KEYBOARD (DBFB)	
		< VIBRATOR >	
X1002	1-527-997-21	VIBRATOR, CRYSTAL 32kHz	
*****			
*	1-634-841-14	LEAF SW(A) BOARD (RA13A)	
		*****	
	3-343-419-01	HOLDER (S SENSER A)	
		< CONNECTOR >	
* CNP81	1-568-852-11	SOCKET, CONNECTOR 9P	
		< IC >	
IC81A	8-719-710-03	IC NJL5165K-B	
		< RESISTOR >	
R84	1-249-417-11	CARBON 1K 5% 1/4W	
R85	1-249-408-11	CARBON 180 5% 1/4W	
		< SWITCH >	
S81	1-571-958-11	SWITCH, PUSH (1 KEY) (STOP DET)	
S82	1-571-281-21	SWITCH, LEAF (CrO2 DET)	
S86	1-571-281-21	SWITCH, LEAF (HALF DET)	
*****			

Ref. No.	Part No.	Description	Remarks
*	1-634-841-14	LEAF SW(B) BOARD (RB22A)	
		*****	
	3-343-419-01	HOLDER (S SENSER A)	
		< CONNECTOR >	
* CNP81	1-568-852-11	SOCKET, CONNECTOR 9P	
		< IC >	
IC81B	8-719-710-03	IC NJL5165K-B	
		< RESISTOR >	
R81	1-249-414-11	CARBON 560 5% 1/4W	
R82	1-247-818-11	CARBON 300 5% 1/4W	
R83	1-247-834-11	CARBON 1.3K 5% 1/4W	
R84	1-249-417-11	CARBON 1K 5% 1/4W	
R85	1-249-408-11	CARBON 180 5% 1/4W	
		< SWITCH >	
S81	1-571-958-11	SWITCH, PUSH (1 KEY) (STOP DET)	
S82	1-571-281-21	SWITCH, LEAF (CrO2 DET)	
S83	1-571-281-21	SWITCH, LEAF (METAL HALF)	
S84	1-571-281-21	SWITCH, LEAF (ERASE PROOF)	
S85	1-571-281-21	SWITCH, LEAF (ERASE PROOF)	
S86	1-571-281-21	SWITCH, LEAF (HALF DET)	
*****			
*	1-638-308-11	LOADING BOARD	
		*****	
		< CONNECTOR >	
CN201	1-580-918-11	HOUSING, CONNECTOR 5P	
		< SWITCH >	
S291	1-571-924-11	SWITCH, LEAF (LOAD OUT)	
S292	1-571-924-11	SWITCH, LEAF (LOAD IN)	
*****			
*	A-4343-548-A	MAIN BOARD, COMPLETE (H170:E,EA)	
		*****	
*	A-4343-553-A	MAIN BOARD, COMPLETE (H170K)	
		*****	
*	A-4343-554-A	MAIN BOARD, COMPLETE (H170:AEP)	
		*****	
*	A-4343-555-A	MAIN BOARD, COMPLETE (H170:G,IT)	
		*****	
*	A-4343-556-A	MAIN BOARD, COMPLETE (H170:EE)	
		*****	
*	A-4343-558-A	MAIN BOARD, COMPLETE (H700)	
		*****	
*	A-4343-575-A	MAIN BOARD, COMPLETE (H170:AUS)	
		*****	

## MAIN (including POWER)

Ref. No.	Part No.	Description	Remarks	Ref. No.	Part No.	Description	Remarks
< CAPACITOR >							
C1	1-162-195-31	CERAMIC 4.7PF 10% 50V (EXCEPT H170:G, IT/H170K/H700)		C89	1-161-379-00	CERAMIC 0.01uF 20% 25V	
C2	1-124-907-11	ELECT 10uF 20% 50V		C90	1-124-477-11	ELECT 47uF 20% 25V	
C3	1-161-379-00	CERAMIC 0.01uF 20% 25V		C91	1-162-294-31	CERAMIC 0.001uF 10% 50V	
C4	1-162-294-31	CERAMIC 0.001uF 10% 50V		C92	1-162-294-31	CERAMIC 0.001uF 10% 50V	
C5	1-101-005-00	CERAMIC 22000PF 50V		C93	1-161-375-00	CERAMIC 0.0022uF 20% 50V	
C6	1-162-851-11	CERAMIC 0.1uF 20% 16V (H170:E, EA, AUS/H170K)		C94	1-161-375-00	CERAMIC 0.0022uF 20% 50V	
C7	1-101-005-00	CERAMIC 22000PF 50V		C95	1-124-903-11	ELECT 1uF 20% 50V	
C8	1-101-005-00	CERAMIC 22000PF 50V (H170:AEP, EE, G, IT/H700)		C96	1-124-903-11	ELECT 1uF 20% 50V	
C9	1-102-120-00	CERAMIC 0.0018uF 10% 50V (H170:AEP, EE, G, IT/H700)		C97	1-124-903-11	ELECT 1uF 20% 50V	
C10	1-161-374-11	CERAMIC 0.0015uF 20% 50V (H170:AEP, EE, G, IT/H700)		C98	1-124-903-11	ELECT 1uF 20% 50V	
C11	1-161-379-00	CERAMIC 0.01uF 20% 25V (H170:G, IT)		C99	1-136-154-00	FILM 0.012uF 5% 50V (EXCEPT H170:G, IT)	
C21	1-161-379-00	CERAMIC 0.01uF 20% 25V (H170:E, EA, AUS/H170K)		C99	1-136-155-00	FILM 0.015uF 5% 50V (H170:G, IT)	
C22	1-102-947-00	CERAMIC 10PF 5% 50V (H170:E, EA, AUS/H170K)		C100	1-136-154-00	FILM 0.012uF 5% 50V (EXCEPT H170:G, IT)	
C23	1-136-162-00	FILM 0.056uF 5% 50V (H170:E, EA, AUS/H170K)		C100	1-136-155-00	FILM 0.015uF 5% 50V (H170:G, IT)	
C24	1-101-005-00	CERAMIC 22000PF 50V (H170:E, EA, AUS/H170K)		C101	1-124-907-11	ELECT 10uF 20% 50V	
C51	1-164-056-11	CERAMIC 27PF 5% 50V		C102	1-161-379-00	CERAMIC 0.01uF 20% 25V	
C52	1-164-056-11	CERAMIC 27PF 5% 50V		C103	1-124-463-00	ELECT 0.1uF 20% 50V	
C53	1-161-379-00	CERAMIC 0.01uF 20% 25V		C104	1-126-160-11	ELECT 1uF 20% 50V	
C54	1-161-379-00	CERAMIC 0.01uF 20% 25V		C105	1-126-160-11	ELECT 1uF 20% 50V	
C55	1-161-379-00	CERAMIC 0.01uF 20% 25V		C106	1-124-903-11	ELECT 1uF 20% 50V	
C56	1-161-379-00	CERAMIC 0.01uF 20% 25V		C107	1-162-282-31	CERAMIC 100PF 10% 50V (H170:G, IT)	
C57	1-161-379-00	CERAMIC 0.01uF 20% 25V		C108	1-162-211-31	CERAMIC 33PF 5% 50V (EXCEPT H170:G, IT)	
C58	1-124-907-11	ELECT 10uF 20% 50V		C108	1-162-291-31	CERAMIC 560PF 5% 50V (H170:G, IT)	
C59	1-161-379-00	CERAMIC 0.01uF 20% 25V		C109	1-161-379-00	CERAMIC 0.01uF 20% 25V	
C60	1-124-477-11	ELECT 47uF 20% 25V		C110	1-161-379-00	CERAMIC 0.01uF 20% 25V	
C61	1-124-925-11	ELECT 2.2uF 20% 100V		C111	1-123-382-00	ELECT 3.3uF 20% 100V	
C62	1-136-153-00	FILM 0.01uF 5% 50V		C112	1-161-379-00	CERAMIC 0.01uF 20% 25V	
C63	1-124-463-00	ELECT 0.1uF 20% 50V		C113	1-161-379-00	CERAMIC 0.01uF 20% 25V (H170:G, IT)	
C64	1-124-902-00	ELECT 0.47uF 20% 50V (H170:AEP, EE, G, IT/H700)		C114	1-161-379-00	CERAMIC 0.01uF 20% 25V	
C65	1-136-157-00	FILM 0.022uF 5% 50V (H170:AEP, EE, G, IT/H700)		C115	1-164-159-11	CERAMIC 0.1uF 50V	
C66	1-136-157-00	FILM 0.022uF 5% 50V (H170:AEP, EE, G, IT/H700)		C116	1-161-379-00	CERAMIC 0.01uF 20% 25V	
C81	1-161-379-00	CERAMIC 0.01uF 20% 25V		C140	1-126-926-11	ELECT 1000uF 20% 10V	
C82	1-124-472-11	ELECT 470uF 20% 10V		C141	1-162-282-31	CERAMIC 100PF 10% 50V	
C83	1-161-379-00	CERAMIC 0.01uF 20% 25V		C142	1-162-282-31	CERAMIC 100PF 10% 50V	
C84	1-124-907-11	ELECT 10uF 20% 50V		C200	1-102-120-00	CERAMIC 0.0018uF 10% 50V (EXCEPT H170:G, IT)	
C85	1-161-379-00	CERAMIC 0.01uF 20% 25V		C200	1-102-123-00	CERAMIC 0.0033uF 10% 50V (H170:G, IT)	
C86	1-162-282-31	CERAMIC 100PF 10% 50V		C201	1-162-282-31	CERAMIC 100PF 10% 50V	
C87	1-161-379-00	CERAMIC 0.01uF 20% 25V		C202	1-162-215-31	CERAMIC 47PF 5% 50V	
C88	1-124-907-11	ELECT 10uF 20% 50V		C203	1-136-172-00	FILM 0.39uF 5% 50V(H170K)	
				C204	1-130-471-00	MYLAR 0.001uF 5% 50V(H170K)	
				C205	1-124-927-11	ELECT 4.7uF 20% 100V	
				C206	1-162-286-31	CERAMIC 220PF 10% 50V	
				C207	1-124-254-00	ELECT 0.68uF 20% 50V	
				C208	1-124-252-00	ELECT 0.33uF 20% 50V	
				C209	1-124-252-00	ELECT 0.33uF 20% 50V	
				C210	1-136-167-00	FILM 0.15uF 5% 50V	
				C211	1-136-166-00	FILM 0.12uF 5% 50V	

## MAIN (including POWER)

Ref. No.	Part No.	Description	Remarks	Ref. No.	Part No.	Description	Remarks
C212	1-136-162-00	FILM 0.056uF 5% 50V		C277	1-164-159-11	CERAMIC 0.1uF 50V	
C213	1-136-161-00	FILM 0.047uF 5% 50V		C281	1-161-379-00	CERAMIC 0.01uF 20% 25V	
C214	1-136-157-00	FILM 0.022uF 5% 50V		C290	1-164-159-11	CERAMIC 0.1uF 50V	
C215	1-136-156-00	FILM 0.018uF 5% 50V		C291	1-164-159-11	CERAMIC 0.1uF 50V	
C216	1-130-482-00	MYLAR 0.0082uF 5% 50V		C292	1-164-159-11	CERAMIC 0.1uF 50V	
				C293	1-164-159-11	CERAMIC 0.1uF 50V	
C217	1-130-481-00	MYLAR 0.0068uF 5% 50V		C301	1-162-282-31	CERAMIC 100PF 10% 50V	(EXCEPT H170:G, IT)
C218	1-130-477-00	MYLAR 0.0033uF 5% 50V		C301	1-162-288-31	CERAMIC 330PF 10% 50V (H170:G, IT)	
C219	1-136-157-00	FILM 0.022uF 5% 50V		C302	1-162-282-31	CERAMIC 100PF 10% 50V	
C220	1-126-096-11	ELECT 10uF 20% 35V		C303	1-130-474-00	MYLAR 0.0018uF 5% 50V	(H170:AEP, EE, G, IT/H700)
C221	1-162-286-31	CERAMIC 220PF 10% 50V		C304	1-130-480-00	MYLAR 0.0056uF 5% 50V	(H170:AEP, EE, G, IT/H700)
C222	1-162-294-31	CERAMIC 0.001uF 10% 50V (H170/H700)		C305	1-124-907-11	ELECT 10uF 20% 50V	(H170:AEP, EE, G, IT/H700)
C224	1-124-464-11	ELECT 0.22uF 20% 50V		C306	1-124-903-11	ELECT 1uF 20% 50V	
C225	1-124-252-00	ELECT 0.33uF 20% 50V		C307	1-164-159-11	CERAMIC 0.1uF 50V	
C227	1-164-159-11	CERAMIC 0.1uF 50V		C308	1-164-159-11	CERAMIC 0.1uF 50V	(H170:AEP, EE, G, IT/H700)
C228	1-124-907-11	ELECT 10uF 20% 50V					
C230	1-161-379-00	CEMATIC 0.01uF 20% 25V (H170:G, IT)		C320	1-162-282-31	CERAMIC 100PF 10% 50V	(H170:AEP, EE/H700)
C231	1-161-379-00	CERAMIC 0.01uF 20% 25V		C320	1-162-294-31	CERAMIC 0.001uF 10% 50V (HCD170:G, IT)	
C232	1-161-379-00	CEMATIC 0.01uF 20% 25V (H170:G, IT)		C351	1-162-282-31	CERAMIC 100PF 10% 50V	(EXCEPT H170:G, IT)
C241	1-161-379-00	CERAMIC 0.01uF 20% 25V		C351	1-162-288-31	CERAMIC 330PF 10% 50V (HCD170:G, IT)	
C242	1-161-379-00	CERAMIC 0.01uF 20% 25V		C352	1-162-282-31	CERAMIC 100PF 10% 50V	
C243	1-161-379-00	CERAMIC 0.01uF 20% 25V		C353	1-130-474-00	MYLAR 0.0018uF 5% 50V	(H170:AEP, EE, G, IT/H700)
C247	1-124-925-11	ELECT 2.2uF 20% 100V		C354	1-130-480-00	MYLAR 0.0056uF 5% 50V	(H170:AEP, EE, G, IT/H700)
C248	1-164-159-11	CERAMIC 0.1uF 50V (H170K)		C355	1-124-907-11	ELECT 10uF 20% 50V	(H170:AEP, EE, G, IT/H700)
C249	1-164-159-11	CERAMIC 0.1uF 50V (H170K)		C356	1-124-903-11	ELECT 1uF 20% 50V	
C250	1-102-120-00	CERAMIC 0.0018uF 10% 50V	(EXCEPT H170:G, IT)	C357	1-164-159-11	CERAMIC 0.1uF 50V	
C250	1-102-123-00	CERAMIC 0.0033uF 10% 50V (H170:G, IT)		C358	1-164-159-11	CERAMIC 0.1uF 50V	(H170:AEP, EE, G, IT/H700)
C251	1-162-282-31	CERAMIC 100PF 10% 50V		C370	1-162-282-31	CERAMIC 100PF 10% 50V	(H170:AEP, EE/H700)
C252	1-162-215-31	CERAMIC 47PF 5% 50V		C370	1-162-294-31	CERAMIC 0.001uF 10% 50V (H170:G, IT)	
C253	1-136-172-00	FILM 0.39uF 5% 50V (H170K)		C418	1-126-916-11	ELECT 1000uF 20% 6.3V	
C254	1-130-471-00	MYLAR 0.001uF 5% 50V (H170K)		C419	1-126-157-11	ELECT 10uF 20% 16V	
C255	1-124-927-11	ELECT 4.7uF 20% 100V		C420	1-126-157-11	ELECT 10uF 20% 16V	
C256	1-162-286-31	CERAMIC 220PF 10% 50V		C801	1-124-907-11	ELECT 10uF 20% 50V	
C257	1-124-254-00	ELECT 0.68uF 20% 50V		C802	1-162-290-31	CERAMIC 470PF 10% 50V	(EXCEPT H170:G, IT)
C258	1-124-252-00	ELECT 0.33uF 20% 50V		C803	1-126-233-11	ELECT 22uF 20% 50V	
C259	1-124-252-00	ELECT 0.33uF 20% 50V		C804	1-164-159-11	CERAMIC 0.1uF 50V (H170:G, IT)	
C260	1-136-167-00	FILM 0.15uF 5% 50V		C805	1-164-159-11	CERAMIC 0.1uF 50V (H170:G, IT)	
C261	1-136-166-00	FILM 0.12uF 5% 50V					
C262	1-136-162-00	FILM 0.056uF 5% 50V		C848	1-126-233-11	ELECT 22uF 20% 50V	
C263	1-136-161-00	FILM 0.047uF 5% 50V		C851	1-124-907-11	ELECT 10uF 20% 50V	
C264	1-136-157-00	FILM 0.022uF 5% 50V		C852	1-162-290-31	CERAMIC 470PF 10% 50V	(EXCEPT H170:G, IT)
C265	1-136-156-00	FILM 0.018uF 5% 50V		C853	1-126-233-11	ELECT 22uF 20% 50V	
C266	1-130-482-00	MYLAR 0.0082uF 5% 50V		C854	1-164-159-11	CERAMIC 0.1uF 50V (H170:G, IT)	
C267	1-130-481-00	MYLAR 0.0068uF 5% 50V					
C268	1-130-477-00	MYLAR 0.0033uF 5% 50V					
C269	1-136-157-00	FILM 0.022uF 5% 50V					
C270	1-126-096-11	ELECT 10uF 20% 35V					
C271	1-162-286-31	CERAMIC 220PF 10% 50V					
C272	1-162-294-31	CERAMIC 0.001uF 10% 50V (H170/H700)					
C274	1-124-464-11	ELECT 0.22uF 20% 50V					
C275	1-124-252-00	ELECT 0.33uF 20% 50V					

## MAIN (including POWER)

Ref. No.	Part No.	Description	Remarks	Ref. No.	Part No.	Description	Remarks
C855	1-164-159-11	CERAMIC	0.1uF 50V (H170:G, IT)			< CIRCUIT BREAKER >	
C871	1-126-953-11	ELECT	2200uF 20% 35V				
C872	1-126-953-11	ELECT	2200uF 20% 35V	CB801	1-532-564-00	BREAKER, CIRCUIT 2.2A	
C873	1-124-120-11	ELECT	220uF 20% 25V	CB851	1-532-564-00	BREAKER, CIRCUIT 2.2A	
C874	1-124-484-11	ELECT	220uF 20% 35V			< FILTER >	
C875	1-126-233-11	ELECT	22uF 20% 50V				
C876	1-124-907-11	ELECT	10uF 20% 50V	CF1	1-567-389-11	FILTER, CERAMIC	
C877	1-126-233-11	ELECT	22uF 20% 50V	CF2	1-567-389-11	FILTER, CERAMIC (H170:G, IT)	
C878	1-124-910-11	ELECT	47uF 20% 50V	CF81	1-567-389-11	FILTER, CERAMIC	
C879	1-124-910-11	ELECT	47uF 20% 50V			< CONNECTOR >	
C880	1-124-910-11	ELECT	47uF 20% 50V	* CN201	1-569-155-11	PLUG, CONNECTOR 10P	
C881	1-162-294-31	CERAMIC	0.001uF 10% 50V (H170:G, IT)	* CN202	1-569-155-11	PLUG, CONNECTOR 10P	
C882	1-162-294-31	CERAMIC	0.001uF 10% 50V (H170:G, IT)	CN203	1-695-026-11	SOCKET, CONNECTOR 10P	
C883	1-162-207-31	CERAMIC	22PF 5% 50V	* CN204	1-568-828-11	SOCKET, CONNECTOR 9P	
C884	1-162-207-31	CERAMIC	22PF 5% 50V	* CN205	1-566-973-21	PIN, CONNECTOR (PC BOARD) 8P	
C891	1-164-159-11	CERAMIC	0.1uF 50V	* CN206	1-566-973-21	PIN, CONNECTOR (PC BOARD) 8P	
C892	1-164-159-11	CERAMIC	0.1uF 50V	* CN207	1-573-085-11	CONNECTOR, FPC (NON ZIF) 19P	
C893	1-164-159-11	CERAMIC	0.1uF 50V	* CN401	1-568-852-11	SOCKET, CONNECTOR 9P	
C894	1-164-159-11	CERAMIC	0.1uF 50V	* CN402	1-568-455-11	PIN, CONNECTOR (PC BOARD) 10P	
C898	1-126-233-11	ELECT	22uF 20% 50V	* CN403	1-568-847-11	SOCKET, CONNECTOR 4P	
C899	1-136-161-00	FILM	0.047uF 5% 50V	* CN404	1-695-070-12	CONNECTOR, FFC/FPC 11P	
C901	1-124-564-11	ELECT	4700uF 20% 25V	* CN801	1-562-573-11	SOCKET, CONNECTOR 8P	
C902	1-124-927-11	ELECT	4.7uF 20% 100V	* CN802	1-564-510-11	PLUG, CONNECTOR 7P	
C903	1-124-927-11	ELECT	4.7uF 20% 100V	* CN803	1-564-509-11	PLUG, CONNECTOR 6P	
C904	1-126-233-11	ELECT	22uF 20% 50V	* CN804	1-695-069-21	CONNECTOR, FFC/FPC 11P	
C905	1-124-927-11	ELECT	4.7uF 20% 100V	* CN901	1-564-510-11	PLUG, CONNECTOR 7P	
C906	1-124-927-11	ELECT	4.7uF 20% 100V	* CN902	1-564-509-11	PLUG, CONNECTOR 6P	
C908	1-124-907-11	ELECT	10uF 20% 50V			< TRIMMER >	
C909	1-124-907-11	ELECT	10uF 20% 50V	CT21	1-141-227-00	CAP, TRIMMER 20PF (H170:E, EA, AUS/H170K)	
C910	1-124-910-11	ELECT	47uF 20% 50V	CT22	1-141-227-00	CAP, TRIMMER 20PF (H170:E, EA, AUS/H170K)	
C911	1-124-910-11	ELECT	47uF 20% 50V			< DIODE >	
C912	1-124-910-11	ELECT	47uF 20% 50V	D21	8-719-976-30	DIODE KV1560N (H170:E, EA, AUS/H170K)	
C913	1-161-379-00	CERAMIC	0.01uF 20% 25V	D81	8-719-987-63	DIODE 1N4148M	
C914	1-161-379-00	CERAMIC	0.01uF 20% 25V (H170:G, IT)	D202	8-719-987-63	DIODE 1N4148M	
C922	1-124-564-11	ELECT	4700uF 20% 25V	D205	8-719-933-33	DIODE HZS6A1L (H170K)	
C923	1-124-252-00	ELECT	0.33uF 20% 50V	D206	8-719-933-33	DIODE HZS6A1L	
C924	1-124-464-11	ELECT	0.22uF 20% 50V	D207	8-719-933-33	DIODE HZS6A1L (H170K)	
C951	1-124-907-11	ELECT	10uF 20% 50V	D208	8-719-987-63	DIODE 1N4148M	
C952	1-126-160-11	ELECT	1uF 20% 50V	D401	8-719-987-63	DIODE 1N4148M	
C953	1-124-903-11	ELECT	1uF 20% 50V	D801	8-719-987-63	DIODE 1N4148M	
C954	1-124-120-11	ELECT	220uF 20% 25V	D901	8-719-200-82	DIODE 11ES2	
C999	1-101-005-00	CERAMIC	22000PF 50V	D902	8-719-200-82	DIODE 11ES2	
C1001	1-162-282-31	CERAMIC	100uF 10% 50V (H170:G, IT)	D904	8-719-933-41	DIODE HZS6C3L	
C2002	1-124-907-11	ELECT	10uF 20% 50V	D905	8-719-200-82	DIODE 11ES2	
C2052	1-124-907-11	ELECT	10uF 20% 50V	D906	8-719-200-82	DIODE 11ES2	
C9001	1-124-907-11	ELECT	10uF 20% 50V	D907	8-719-011-22	DIODE UZ-36BSB	
C9002	1-124-034-51	ELECT	33uF 20% 16V				



**MAIN** (including POWER)

Ref. No.	Part No.	Description	Remarks
D909	8-719-001-15	DIODE UZL-9M2	
D910	8-719-987-63	DIODE 1N4148M	
D914	8-719-987-63	DIODE 1N4148M	
D915	8-719-987-63	DIODE 1N4148M	
D916	8-719-987-63	DIODE 1N4148M	
D921	8-719-987-63	DIODE 1N4148M	
D923	8-719-200-82	DIODE 11ES2	
D924	8-719-200-82	DIODE 11ES2	
< CONNECTOR >			
* DIP801	1-562-327-00	SOCKET, CONNECTOR 3P	
* DIP802	1-562-327-00	SOCKET, CONNECTOR 3P	
* DIP803	1-562-327-00	SOCKET, CONNECTOR 3P	
* DIP804	1-562-327-00	SOCKET, CONNECTOR 3P	
< FRONTEND >			
FE1	1-465-007-11	FRONT END FM(4 GANG) (H170:G, IT)	
FE1	1-465-852-11	FRONT END (3 BAND) (H170:EE)	
FE1	1-465-673-11	FRONT END (EXCEPT H170:EE, G, IT)	
FE2	1-236-462-11	ENCAPSULATED COMPONENT (H170:AEP, EE, G, IT/H700)	
FE2	1-236-777-11	ENCAPSULATED COMPONENT (H170:E, EA, AUS/H170K)	
FE3	1-236-463-11	ENCAPSULATED COMPONENT (H170:AEP, EE, G, IT/H700)	
FL81	1-236-465-11	ENCAPSULATED COMPONENT (H170:G, IT)	
< IC >			
IC51	8-759-820-91	IC LC7218	
IC81	8-759-821-45	IC LA1851N	
IC201	8-759-603-14	IC M5229P	
IC231	8-759-000-49	IC MC14066BCP	
IC232	8-759-634-51	IC M5218AF	
IC234	8-759-822-26	IC LC7522K	
IC236	8-759-000-49	IC MC14066BCP(H170K)	
IC251	8-759-603-14	IC M5229P	
IC301	8-759-634-51	IC M5218AF (H170:AEP, EE, G, IT/H700)	
IC302	8-759-000-48	IC MC14052BCP	
IC406	8-759-820-62	IC LB1639	
IC801	8-749-920-13	IC STK-4132MK2	
IC901	8-759-602-66	IC M5230L-A	
IC902	8-759-821-93	IC LA5601	
IC9001	8-759-520-90	IC PST572E	
< IFT >			
IFT81	1-404-713-11	TRANSFORMER, IF	
IFT82	1-404-807-11	TRANSFORMER, DISCRIMINATOR	
< JACK >			
J301	1-569-181-11	JACK, PIN 2P (VIDEO/AUX)	

Ref. No.	Part No.	Description	Remarks
< COIL >			
FB801	1-410-858-10	INDUCTOR (Small TYPE) (H170:G, IT)	
FB802	1-410-858-10	INDUCTOR (Small TYPE) (H170:G, IT)	
L1	1-408-425-00	INDUCTOR 220uH (H170:AEP, EE, G, IT/H700)	
L81	1-408-399-00	INDUCTOR 1.5uH	
L83	1-410-489-11	INDUCTOR 390uH	
L1001	1-410-521-11	INDUCTOR 100uH (H170:G, IT)	
< FILTER >			
LPF81	1-235-164-00	FILTER, LOW PASS	
LPF82	1-235-164-00	FILTER, LOW PASS	
< TRANSISTOR >			
Q1	8-729-620-19	TRANSISTOR 2SC2724-CD	
Q2	8-729-620-19	TRANSISTOR 2SC2724-CD (H170:G, IT)	
Q4	8-729-900-61	TRANSISTOR DTA114ES	
Q5	8-729-900-80	TRANSISTOR DTC114ES	
Q7	8-729-119-76	TRANSISTOR 2SA1175-HFE	
Q8	8-729-119-76	TRANSISTOR 2SA1175-HFE	
Q9	8-729-900-80	TRANSISTOR DTC114ES	
Q10	8-729-900-74	TRANSISTOR DTC143TS (H170:AEP, EE, G, IT/H700)	
Q10	8-729-900-80	TRANSISTOR DTC114ES (H170:E, EA, AUS/H170K)	
Q11	8-729-620-05	TRANSISTOR 2SC2603-EF (H170:E, EA, AUS/H170K)	
Q51	8-729-202-67	TRANSISTOR 2SK246-GR3	
Q52	8-729-201-83	TRANSISTOR 2SC3112-A	
Q53	8-729-202-67	TRANSISTOR 2SK246-GR3 (H170:AEP, EE, G, IT/H700)	
Q54	8-729-201-83	TRANSISTOR 2SC3112 (H170:AEP, EE, G, IT/H700)	
Q101	8-729-620-05	TRANSISTOR 2SC2603-EF	
Q102	8-729-620-05	TRANSISTOR 2SC2603-EF	
Q103	8-729-900-80	TRANSISTOR DTC114ES	
Q201	8-729-202-67	TRANSISTOR 2SK246-GR3	
Q202	8-729-141-26	TRANSISTOR 2SC3622A-LK	
Q231	8-729-900-63	TRANSISTOR DTA124ES (H170K)	
Q232	8-729-900-63	TRANSISTOR DTA124ES	
Q233	8-729-119-76	TRANSISTOR 2SA1175-HFE	
Q234	8-729-900-63	TRANSISTOR DTA124ES	
Q235	8-729-900-63	TRANSISTOR DTA124ES (H170K)	
Q236	8-729-900-80	TRANSISTOR DTC114ES (H170K)	
Q237	8-729-620-05	TRANSISTOR 2SC2603-EF	
Q251	8-729-202-67	TRANSISTOR 2SK246-GR3	
Q252	8-729-141-26	TRANSISTOR 2SC3622A-LK	
Q301	8-729-900-61	TRANSISTOR DTA114ES	
Q302	8-729-900-61	TRANSISTOR DTA114ES	
Q901	8-729-620-05	TRANSISTOR 2SC2603-EF	
Q903	8-729-209-15	TRANSISTOR 2SD2012	
Q904	8-729-141-83	TRANSISTOR 2SB1094-LK	
Q905	8-729-620-05	TRANSISTOR 2SC2603-EF	
Q906	8-729-209-15	TRANSISTOR 2SD2012	

## MAIN (including POWER)

Ref. No.	Part No.	Description	Remarks	Ref. No.	Part No.	Description	Remarks
Q907	8-729-209-15	TRANSISTOR	2SD2012	R61	1-249-410-11	CARBON	270 5% 1/4W
Q908	8-729-209-15	TRANSISTOR	2SD2012	R62	1-249-425-11	CARBON	4.7K 5% 1/4W
Q911	8-729-900-80	TRANSISTOR	DTC114ES	R63	1-249-421-11	CARBON	2.2K 5% 1/4W
Q8001	8-729-900-89	TRANSISTOR	DTC144ES	R64	1-249-425-11	CARBON	4.7K 5% 1/4W
Q9001	8-729-900-80	TRANSISTOR	DTC114ES	R65	1-249-425-11	CARBON	4.7K 5% 1/4W
Q9002	8-729-900-80	TRANSISTOR	DTC114ES	R66	1-249-405-11	CARBON	100 5% 1/4W
Q9003	8-729-620-05	TRANSISTOR	2SC2603-EF	R67	1-249-423-11	CARBON	3.3K 5% 1/4W (H170:AEP, EE, G, IT/H700)
< RESISTOR >				R68	1-249-414-11	CARBON	560 5% 1/4W (H170:AEP, EE, G, IT/H700)
R1	1-249-411-11	CARBON	330 5% 1/4W	R69	1-249-417-11	CARBON	1K 5% 1/4W (H170:AEP, EE, G, IT/H700)
R2	1-249-411-11	CARBON	330 5% 1/4W	R70	1-249-410-11	CARBON	270 5% 1/4W (H170:AEP, EE, G, IT/H700)
R3	1-247-891-00	CARBON	330K 5% 1/4W	R71	1-249-433-11	CARBON	22K 5% 14W (H170:AEP, EE, G, IT/H700)
R4	1-249-411-11	CARBON	330 5% 1/4W	R72	1-249-421-11	CARBON	2.2K 5% 1/4W (H170:AEP, EE, G, IT/H700)
R5	1-249-891-00	CARBON	330K 5% 1/4W (H170:G, IT)	R73	1-249-425-11	CARBON	4.7K 5% 1/4W (H170:AEP, EE, G, IT/H700)
R6	1-249-411-11	CARBON	330 5% 1/4W (H170:G, IT)	R74	1-249-425-11	CARBON	4.7K 5% 1/4W (H170:AEP, EE, G, IT/H700)
R7	1-249-407-11	CARBON	150 5% 1/4W (H170:G, IT)	R75	1-249-425-11	CARBON	4.7K 5% 1/4W (H170:AEP, EE, G, IT/H700)
R7	1-249-405-11	CARBON	100 5% 1/4W (EXCEPT H170:G, IT)	R76	1-249-433-11	CARBON	22K 5% 1/4W (H170:AEP, EE, G, IT/H700)
R8	1-249-441-11	CARBON	100K 5% 1/4W	R77	1-249-421-11	CARBON	2.2K 5% 1/4W (H170:AEP, EE, G, IT/H700)
R9	1-249-437-11	CARBON	47K 5% 1/4W	R78	1-249-429-11	CARBON	10K 5% 1/4W (H170:AEP, EE, G, IT/H700)
R10	1-249-429-11	CARBON	10K 5% 1/4W	R79	1-249-429-11	CARBON	10K 5% 1/4W (H170:AEP, EE, G, IT/H700)
R11	1-249-421-11	CARBON	2.2K 5% 1/4W	R80	1-249-429-11	CARBON	10K 5% 1/4W (H170:AEP, EE, G, IT/H700)
R12	1-249-421-11	CARBON	2.2K 5% 1/4W	R81	1-249-433-11	CARBON	22K 5% 1/4W
R13	1-249-433-11	CARBON	22K 5% 1/4W (H170:AEP, EE, G, IT/H700)	R82	1-249-417-11	CARBON	1K 5% 1/4W
R14	1-249-432-11	CARBON	18K 5% 1/4W (H170:AEP, EE, G, IT/H700)	R83	1-249-399-11	CARBON	33 5% 1/4W
R15	1-247-903-00	CARBON	1M 5% 1/4W (H170:AEP, EE, G, IT/H700)	R84	1-249-429-11	CARBON	10K 5% 1/4W
R20	1-249-425-11	CARBON	4.7K 5% 1/4W	R85	1-249-429-11	CARBON	10K 5% 1/4W
R21	1-249-437-11	CARBON	47K 5% 1/4W (H170:E, EA, AUS/H170K)	R86	1-249-437-11	CARBON	47K 5% 1/4W
R31	1-249-429-11	CARBON	10K 5% 1/4W	R87	1-249-409-11	CARBON	220 5% 1/4W
R32	1-249-429-11	CARBON	10K 5% 1/4W	R88	1-249-429-11	CARBON	10K 5% 1/4W
R39	1-247-903-00	CARBON	1M 5% 1/4W (H170:E, EA, AUS/H170K)	R89	1-249-429-11	CARBON	10K 5% 1/4W
R41	1-249-429-11	CARBON	10K 5% 1/4W	R90	1-249-421-11	CARBON	2.2K 5% 1/4W
R48	1-249-429-11	CARBON	10K 5% 1/4W (H170:E, EA, AUS/H170K)	R91	1-249-421-11	CARBON	2.2K 5% 1/4W
R49	1-249-437-11	CARBON	47K 5% 1/4W (H170:E, EA, AUS/H170K)	R92	1-247-891-00	CARBON	330K 5% 1/4W
R50	1-249-417-11	CARBON	1K 5% 1/4W	R93	1-247-891-00	CARBON	330K 5% 1/4W
R51	1-249-417-11	CARBON	1K 5% 1/4W	R94	1-249-420-11	CARBON	1.8K 5% 1/4W
R52	1-249-417-11	CARBON	1K 5% 1/4W	R95	1-249-420-11	CARBON	1.8K 5% 1/4W
R53	1-249-417-11	CARBON	1K 5% 1/4W	R96	1-249-425-11	CARBON	4.7K 5% 1/4W
R54	1-249-417-11	CARBON	1K 5% 1/4W	R97	1-249-425-11	CARBON	4.7K 5% 1/4W
R55	1-249-425-11	CARBON	4.7K 5% 1/4W	R98	1-249-404-00	CARBON	82 5% 1/4W
R56	1-249-405-11	CARBON	100 5% 1/4W	R99	1-249-417-11	CARBON	1K 5% 1/4W (EXCEPT H170:G, IT)
R57	1-249-401-11	CARBON	47 5% 1/4W	R99	1-249-420-11	CARBON	1.8K 5% 1/4W (H170:G, IT)
R58	1-249-423-11	CARBON	3.3K 5% 1/4W	R100	1-247-848-11	CARBON	5.1K 5% 1/4W
R59	1-249-414-11	CARBON	560 5% 1/4W	R102	1-249-430-11	CARBON	12K 5% 1/4W (EXCEPT H170:G, IT)
R60	1-249-417-11	CARBON	1K 5% 1/4W	R103	1-249-428-11	CARBON	8.2K 5% 1/4W
				R104	1-249-435-11	CARBON	33K 5% 1/4W
				R107	1-249-430-11	CARBON	12K 5% 1/4W (H170:G, IT)
				R108	1-249-417-11	CARBON	1K 5% 1/4W
				R142	1-249-417-11	CARBON	1K 5% 1/4W
				R143	1-249-431-11	CARBON	15K 5% 1/4W

**MAIN** (including POWER)

Ref. No.	Part No.	Description	Remarks	Ref. No.	Part No.	Description	Remarks
R144	1-249-393-11	CARBON	10 5% 1/4W	R271	1-249-441-11	CARBON	100K 5% 1/4W
R200	1-247-887-00	CARBON	220K 5% 1/4W	R272	1-249-441-11	CARBON	100K 5% 1/4W
R201	1-249-429-11	CARBON	10K 5% 1/4W	R277	1-247-887-00	CARBON	220K 5% 1/4W
R202	1-247-862-11	CARBON	20K 5% 1/4W	R278	1-247-887-00	CARBON	220K 5% 1/4W
R203	1-249-429-11	CARBON	10K 5% 1/4W	R283	1-249-441-11	CARBON	100K 5% 1/4W
R204	1-249-429-11	CARBON	10K 5% 1/4W (H170K)	R285	1-249-441-11	CARBON	100K 5% 1/4W
R205	1-247-903-00	CARBON	1M 5% 1/4W (H170K)	R287	1-247-862-11	CARBON	20K 5% 1/4W
R206	1-249-427-11	CARBON	6.8K 5% 1/4W	R290	1-249-437-11	CARBON	47K 5% 1/4W
R209	1-247-903-00	CARBON	1M 5% 1/4W	R294	1-249-442-11	CARBON	510 5% 1/4W
R210	1-247-903-00	CARBON	1M 5% 1/4W	R295	1-249-441-11	CARBON	100K 5% 1/4W (H170K)
R211	1-247-903-00	CARBON	1M 5% 1/4W	R296	1-249-441-11	CARBON	100K 5% 1/4W (H170K)
R212	1-247-903-00	CARBON	1M 5% 1/4W	R297	1-249-433-11	CARBON	22K 5% 1/4W
R213	1-247-903-00	CARBON	1M 5% 1/4W	R298	1-249-441-11	CARBON	100K 5% 1/4W
R214	1-247-903-00	CARBON	1M 5% 1/4W	R299	1-249-433-11	CARBON	22K 5% 1/4W (H170K)
R215	1-249-423-11	CARBON	3.3K 5% 1/4W	R301	1-249-417-11	CARBON	1K 5% 1/4W
R216	1-247-903-00	CARBON	1M 5% 1/4W	R302	1-249-437-11	CARBON	47K 5% 1/4W
R217	1-249-427-11	CARBON	6.8K 5% 1/4W	R303	1-249-437-11	CARBON	47K 5% 1/4W (H170:AEP, EE, G, IT/H700)
R221	1-249-441-11	CARBON	100K 5% 1/4W	R304	1-247-897-11	CARBON	560K 5% 1/4W (H170:AEP, EE, G, IT/H700)
R222	1-249-441-11	CARBON	100K 5% 1/4W	R305	1-249-417-11	CARBON	1K 5% 1/4W (H170:AEP, EE, G, IT/H700)
R227	1-247-887-00	CARBON	220K 5% 1/4W	R306	1-249-417-11	CARBON	1K 5% 1/4W
R228	1-247-887-00	CARBON	220K 5% 1/4W	R307	1-249-437-11	CARBON	47K 5% 1/4W
R235	1-249-441-11	CARBON	100K 5% 1/4W	R308	1-249-417-11	CARBON	1K 5% 1/4W
R236	1-249-417-11	CARBON	1K 5% 1/4W	R309	1-249-417-11	CARBON	1K 5% 1/4W
R237	1-247-862-11	CARBON	20K 5% 1/4W	R310	1-249-417-11	CARBON	1K 5% 1/4W
R240	1-249-433-11	CARBON	22K 5% 1/4W (H170K)	R340	1-249-433-11	CARBON	22K 5% 1/4W
R241	1-249-433-11	CARBON	22K 5% 1/4W	R341	1-249-433-11	CARBON	22K 5% 1/4W
R242	1-249-417-11	CARBON	1K 5% 1/4W	R351	1-249-417-11	CARBON	1K 5% 1/4W
R243	1-249-417-11	CARBON	1K 5% 1/4W	R352	1-249-437-11	CARBON	47K 5% 1/4W
R244	1-247-816-11	CARBON	240 5% 1/4W	R353	1-249-437-11	CARBON	47K 5% 1/4W (H170:AEP, EE, G, IT/H700)
R245	1-249-433-11	CARBON	22K 5% 1/4W	R354	1-247-897-11	CARBON	560K 5% 1/4W (H170:AEP, EE, G, IT/H700)
R246	1-247-903-00	CARBON	1M 5% 1/4W	R355	1-249-417-11	CARBON	1K 5% 1/4W (H170:AEP, EE, G, IT/H700)
R247	1-247-854-11	CARBON	9.1K 5% 1/4W	R356	1-249-417-11	CARBON	1K 5% 1/4W
R248	1-249-437-11	CARBON	47K 5% 1/4W	R357	1-249-437-11	CARBON	47K 5% 1/4W
R249	1-249-433-11	CARBON	22K 5% 1/4W (H170K)	R358	1-249-417-11	CARBON	1K 5% 1/4W
R250	1-247-887-00	CARBON	220K 5% 1/4W	R359	1-249-417-11	CARBON	1K 5% 1/4W
R251	1-249-429-11	CARBON	10K 5% 1/4W	R360	1-249-417-11	CARBON	1K 5% 1/4W
R252	1-247-862-11	CARBON	20K 5% 1/4W	R407	1-247-887-00	CARBON	220K 5% 1/4W
R253	1-249-429-11	CARBON	10K 5% 1/4W	R457	1-247-887-00	CARBON	220K 5% 1/4W
R254	1-249-429-11	CARBON	10K 5% 1/4W (H170K)	R486	1-249-413-11	CARBON	470 5% 1/4W
R255	1-247-903-00	CARBON	1M 5% 1/4W (H170K)	R801	1-249-417-11	CARBON	1K 5% 1/4W
R256	1-249-427-11	CARBON	6.8K 5% 1/4W	R802	1-249-438-11	CARBON	56K 5% 1/4W
R259	1-247-903-00	CARBON	1M 5% 1/4W	R803	1-249-413-11	CARBON	470 5% 1/4W (EXCEPT H170:EE, G, IT)
R260	1-247-903-00	CARBON	1M 5% 1/4W	R804	1-249-438-11	CARBON	56K 5% 1/4W
R261	1-247-903-00	CARBON	1M 5% 1/4W	R805	1-249-389-11	CARBON	4.7 5% 1/4W (H170:G, IT)
R262	1-247-903-00	CARBON	1M 5% 1/4W	R851	1-249-417-11	CARBON	1K 5% 1/4W
R263	1-247-903-00	CARBON	1M 5% 1/4W				
R264	1-247-903-00	CARBON	1M 5% 1/4W				
R265	1-249-423-11	CARBON	3.3K 5% 1/4W				
R266	1-247-903-00	CARBON	1M 5% 1/4W				
R267	1-249-427-11	CARBON	6.8K 5% 1/4W				

MAIN (including POWER)

MD- A

Ref. No.	Part No.	Description	Remarks
R852	1-249-438-11	CARBON	56K 5% 1/4W
R853	1-249-413-11	CARBON	470 5% 1/4W
R854	1-249-438-11	CARBON	56K 5% 1/4W
R855	1-249-389-11	CARBON	4.7 5% 1/4W (H170:G, IT)
R871	1-249-429-11	CARBON	10K 5% 1/4W
R872	1-249-437-11	CARBON	47K 5% 1/4W
R873	1-249-429-11	CARBON	10K 5% 1/4W
R874	1-247-883-00	CARBON	150K 5% 1/4W
R875	1-249-421-11	CARBON	2.2K 5% 1/4W
R876	1-249-421-11	CARBON	2.2K 5% 1/4W
△R877	1-212-881-11	FUSIBLE	100 5% 1/4W F
R878	1-249-417-11	CARBON	1K 5% 1/4W
R879	1-249-417-11	CARBON	1K 5% 1/4W
△R880	1-212-881-11	FUSIBLE	100 5% 1/4W F
R881	1-249-421-11	CARBON	2.2K 5% 1/4W
R882	1-249-421-11	CARBON	2.2K 5% 1/4W
△R883	1-212-881-11	FUSIBLE	100 5% 1/4W F
△R889	1-212-849-00	FUSIBLE	4.7 5% 1/4W F
R891	1-249-389-11	CARBON	4.7 5% 1/4W
R892	1-249-389-11	CARBON	4.7 5% 1/4W
△R900	1-212-934-00	FUSIBLE	1 5% 1/2W F
△R901	1-212-950-00	FUSIBLE	4.7 5% 1/2W F
△R902	1-219-108-11	FUSIBLE	1.5 5% 1W F
R903	1-247-903-00	CARBON	1M 5% 1/4W
R904	1-249-405-11	CARBON	100 5% 1/4W
R905	1-249-432-11	CARBON	18K 5% 1/4W
R906	1-247-842-11	CARBON	3K 5% 1/4W
R907	1-249-431-11	CARBON	15K 5% 1/4W
R908	1-247-854-11	CARBON	9.1K 5% 1/4W
△R909	1-219-153-11	FUSIBLE	10 5% 1/4W F
R910	1-249-417-11	CARBON	1K 5% 1/4W
R911	1-249-417-11	CARBON	1K 5% 1/4W
△R913	1-212-942-00	FUSIBLE	2.2 5% 1/2W F
R914	1-249-423-11	CARBON	3.3K 5% 1/4W
R921	1-249-429-11	CARBON	10K 5% 1/4W
R922	1-249-441-11	CARBON	100K 5% 1/4W
R923	1-249-429-11	CARBON	10K 5% 1/4W
△R924	1-217-637-00	FUSIBLE	1 5% 1/4W F
R927	1-249-417-11	CARBON	1K 5% 1/4W
R928	1-249-417-11	CARBON	1K 5% 1/4W
R952	1-247-903-00	CARBON	1M 5% 1/4W
R953	1-247-903-00	CARBON	1M 5% 1/4W
R954	1-247-903-00	CARBON	1M 5% 1/4W
R955	1-249-429-11	CARBON	10K 5% 1/4W
△R999	9-910-999-33	FUSIBLE	0.22 5% 1/4W F
R2001	1-249-441-11	CARBON	100K 5% 1/4W (H170/H700)
R2002	1-249-421-11	CARBON	2.2K 5% 1/4W
R2003	1-249-433-11	CARBON	22K 5% 1/4W
R2004	1-249-433-11	CARBON	22K 5% 1/4W
R2052	1-249-421-11	CARBON	2.2K 5% 1/4W

Ref. No.	Part No.	Description	Remarks
R8001	1-249-417-11	CARBON	1K 5% 1/4W
R9001	1-249-429-11	CARBON	10K 5% 1/4W
R9002	1-249-429-11	CARBON	10K 5% 1/4W
R9003	1-249-429-11	CARBON	10K 5% 1/4W
R9004	1-249-429-11	CARBON	10K 5% 1/4W
< VARIABLE RESISTOR >			
RV81	1-238-601-11	RES, ADJ, CARBON	22K
RV82	1-238-601-11	RES, ADJ, CARBON	22K
RV406	1-241-998-11	RES, VAR, CARBON	100K X2(VOLUME)
< COIL >			
T1	1-402-424-11	COIL (ANT, SW3) (H170:E, EA, AUS/H170K)	
T2	1-406-346-11	COIL (OSC, SW3) (H170:E, EA, AUS/H170K)	
< TERMINAL >			
* TB1	1-537-138-31	TERMINAL BOARD (ANT) (H170:AEP, EE, G, IT/H700)	
TB1	1-537-238-21	TERMINAL BOARD (H170:E, EA, AUS/H170K)	
* TB2	4-925-530-01	PLATE, GROUND (H170/H170K)	
* TB3	4-942-204-01	PLATE, GROUND	
TM301	1-537-238-11	TERMINAL BOARD (SPEAKER)	
< TEST PIN >			
* TP81	1-568-449-11	HOUSING, CONNECTOR(PC BOARD)3P	
< VIBRATOR >			
X51	1-577-126-11	VIBRATOR, CRYSTAL 7.2MHz	
X81	1-577-075-11	OSCILLATOR, CERAMIC 456kHz	
*****			
* A-2006-399-A	MD-A BOARD (RA13A)	*****	
< CAPACITOR >			
C11	1-163-131-00	CERAMIC CHIP 390PF	5% 50V
C12	1-136-157-00	FILM 0.022uF	5% 50V
C13	1-124-234-00	ELECT 22uF	20% 16V
C18	1-163-117-00	CERAMIC CHIP 100PF	5% 50V
C21	1-163-131-00	CERAMIC CHIP 390PF	5% 50V
C22	1-136-157-00	FILM 0.022uF	5% 50V
C23	1-124-234-00	ELECT 22uF	20% 16V
C28	1-163-117-00	CERAMIC CHIP 100PF	5% 50V
C31	1-124-234-00	ELECT 22uF	20% 16V
C32	1-124-234-00	ELECT 22uF	20% 16V
C71	1-124-499-11	ELECT, NONPOLAR R 1uF	20% 50V
< JACK >			
* CNJ31	1-580-782-11	CONNECTOR, BOARD TO BOARD	
* CNJ72	1-580-411-11	SOCKET, CONNECTOR 4P	

**Note:** The components identified by mark △ or dotted line with mark △ are critical for safety. Replace only with part number specified.

**MD- A**   **MD- B**

Ref. No.	Part No.	Description	Remarks
< CONNECTOR >			
* CNP32	1-580-772-11	PIN, CONNECTOR (PC BOARD) 4P	
* CNP71	1-564-719-11	PIN, CONNECTOR (SMALL TYPE) 3P	
< IC >			
IC31A	8-759-106-02	IC    uPC4570G2	
< JUMPER RESISTOR >			
JW1	1-216-295-00	METAL CHIP    0    5%    1/10W	
JW51	1-216-296-00	METAL CHIP    0    5%    1/8W	
JW52	1-216-296-00	METAL CHIP    0    5%    1/8W	
JW53	1-216-296-00	METAL CHIP    0    5%    1/8W	
JW54	1-216-296-00	METAL CHIP    0    5%    1/8W	
< TRANSISTOR >			
Q71A	8-729-602-36	TRANSISTOR    2SA1602	
< RESISTOR >			
R11	1-216-099-00	METAL CHIP    120K 5%    1/10W	
R12	1-216-025-00	METAL CHIP    100    5%    1/10W	
R13	1-216-100-00	METAL GLAZE    130K 5%    1/10W	
R14	1-216-067-00	METAL CHIP    5.6K 5%    1/10W	
R21	1-216-099-00	METAL CHIP    120K 5%    1/10W	
R22	1-216-025-00	METAL CHIP    100    5%    1/10W	
R23	1-216-100-00	METAL GLAZE    130K 5%    1/10W	
R24	1-216-067-00	METAL CHIP    5.6K 5%    1/10W	
R31	1-216-033-00	METAL CHIP    220    5%    1/10W	
R32	1-216-033-00	METAL CHIP    220    5%    1/10W	
R71	1-216-082-00	METAL GLAZE    24K    5%    1/10W	
R72	1-216-081-00	METAL CHIP    22K    5%    1/10W	
R73	1-216-089-00	METAL CHIP    47K    5%    1/10W	
R74	1-216-089-00	METAL CHIP    47K    5%    1/10W	
< VARIABLE RESISTOR >			
RV11A	1-238-012-11	RES, ADJ, CARBON 1K (EXCEPT H170:EE)	
RV11A	1-241-627-11	RES, ADJ, CARBON 1K (H170:EE)	
RV21A	1-238-012-11	RES, ADJ, CARBON 1K (EXCEPT H170:EE)	
RV21A	1-241-627-11	RES, ADJ, CARBON 1K (H170:EE)	
RV71A	1-238-016-11	RES, ADJ, CARBON 10K (EXCEPT H170:EE)	
RV71A	1-241-630-11	RES, ADJ, CARBON 10K (H170:EE)	
RV72A	1-238-016-11	RES, ADJ, CARBON 10K (EXCEPT H170:EE)	
RV72A	1-241-630-11	RES, ADJ, CARBON 10K (H170:EE)	
*****			
*	A-2006-400-A	MD-B BOARD (RB22A)	
*****			
< CAPACITOR >			
C11	1-163-131-00	CERAMIC CHIP 390PF    5%    50V	

Ref. No.	Part No.	Description	Remarks
C12	1-136-157-00	FILM    0.022uF    5%    50V	
C13	1-124-234-00	ELECT    22uF    20%    16V	
C14	1-136-273-91	FILM    75PF    5%    630V	
C15	1-164-080-11	CERAMIC    390PF    10%    50V	
C17	1-163-103-00	CERAMIC CHIP 27PF    5%    50V	
C18	1-163-117-00	CERAMIC CHIP 100PF    5%    50V	
C21	1-163-131-00	CERAMIC CHIP 390PF    5%    50V	
C22	1-136-157-00	FILM    0.022uF    5%    50V	
C23	1-124-234-00	ELECT    22uF    20%    16V	
C24	1-136-273-91	FILM    75PF    5%    630V	
C25	1-164-080-11	CERAMIC    390PF    10%    50V	
C27	1-163-103-00	CERAMIC CHIP 27PF    5%    50V	
C28	1-163-117-00	CERAMIC CHIP 100PF    5%    50V	
C31	1-124-234-00	ELECT    22uF    20%    16V	
C32	1-124-234-00	ELECT    22uF    20%    16V	
C33	1-124-234-00	ELECT    22uF    20%    16V	
C51	1-163-019-00	CERAMIC CHIP 0.0068uF 10%    50V	
C52	1-163-019-00	CERAMIC CHIP 0.0068uF 10%    50V	
C53	1-163-022-00	CERAMIC CHIP 0.012uF 10%    50V	
C54	1-136-559-11	FILM    0.0047uF 5%    630V	
C56	1-164-505-11	CERAMIC CHIP 2.2uF    16V	
C57	1-164-346-11	CERAMIC CHIP 1uF    16V	
C58	1-163-024-00	CERAMIC CHIP 0.018uF 10%    50V	
C71	1-124-499-11	ELECT, NONPOLAR R 1uF 20%    50V	
< JACK >			
* CNJ31	1-580-782-11	CONNECTOR, BOARD TO BOARD	
* CNJ33	1-580-782-11	CONNECTOR, BOARD TO BOARD	
* CNJ72	1-580-411-11	SOCKET, CONNECTOR 4P	
< CONNECTOR >			
* CNP32	1-580-781-11	PIN, CONNECTOR (PC BOARD) 7P	
* CNP71	1-564-719-11	PIN, CONNECTOR (SMALL TYPE) 3P	
< DIODE >			
D31	8-719-016-74	DIODE    1SS352	
< IC >			
IC31B	8-759-106-02	IC    uPC4570G2	
< JUMPER RESISTOR >			
JW1	1-216-296-00	METAL CHIP    0    5%    1/8W	
JW2	1-216-295-00	METAL CHIP    0    5%    1/10W	
JW3	1-216-295-00	METAL CHIP    0    5%    1/10W	
JW4	1-216-295-00	METAL CHIP    0    5%    1/10W	
JW5	1-216-295-00	METAL CHIP    0    5%    1/10W	
JW6	1-216-295-00	METAL CHIP    0    5%    1/10W	
JW7	1-216-295-00	METAL CHIP    0    5%    1/10W	
JW52	1-216-296-00	METAL CHIP    0    5%    1/8W	
JW53	1-216-296-00	METAL CHIP    0    5%    1/8W	

**MD- B****SUB (including POWER TRANSFORMER/VOLUME/MIC HP/SW)**

Ref. No.	Part No.	Description	Remarks	Ref. No.	Part No.	Description	Remarks
JW54	1-216-296-00	METAL CHIP	0 5% 1/8W	RV22	1-238-551-11	RES, ADJ, CARBON 220K	
JW55	1-216-296-00	METAL CHIP	0 5% 1/8W	RV71B	1-238-016-11	RES, ADJ, CARBON 10K (EXCEPT H170:EE)	
JW56	1-216-296-00	METAL CHIP	0 5% 1/8W	RV71B	1-241-630-11	RES, ADJ, CARBON 10K (H170:EE)	
JW57	1-216-296-00	METAL CHIP	0 5% 1/8W	RV72B	1-238-016-11	RES, ADJ, CARBON 10K (EXCEPT H170:EE)	
JW58	1-216-296-00	METAL CHIP	0 5% 1/8W	RV72B	1-241-630-11	RES, ADJ, CARBON 10K (H170:EE)	
JW59	1-216-296-00	METAL CHIP	0 5% 1/8W			< RELAY >	
JW60	1-216-296-00	METAL CHIP	0 5% 1/8W	RY31	1-515-726-11	RELAY	
JW61	1-216-296-00	METAL CHIP	0 5% 1/8W			< TRANSFORMER >	
		< COIL >		T51	1-406-419-11	COIL, BIAS OSCILLATION	
L11	1-410-780-11	INDUCTOR	27mH				
L21	1-410-780-11	INDUCTOR	27mH				
		< TRANSISTOR >					
Q51	8-729-808-01	TRANSISTOR	2SD1622-S	*	A-4343-549-A	SUB BOARD, COMPLETE (H170:E, EA)	
Q52	8-729-808-01	TRANSISTOR	2SD1622-S			*****	
Q53	8-729-808-01	TRANSISTOR	2SD1622-S	*	A-4343-550-A	SUB BOARD, COMPLETE (H170:AEP, EE/H700)	
Q71B	8-729-602-36	TRANSISTOR	2SA1602			*****	
		< RESISTOR >		*	A-4343-551-A	SUB BOARD, COMPLETE (H170:G, IT)	
R11	1-216-099-00	METAL CHIP	120K 5% 1/10W			*****	
R12	1-216-025-00	METAL CHIP	100 5% 1/10W	*	A-4343-552-A	SUB BOARD, COMPLETE (H170K)	
R13	1-216-100-00	METAL GLAZE	130K 5% 1/10W			*****	
R14	1-216-067-00	METAL CHIP	5.6K 5% 1/10W	*	A-4343-573-A	SUB BOARD, COMPLETE (H170:AUS)	
R15	1-249-430-11	CARBON	12K 5% 1/4W			*****	
R21	1-216-099-00	METAL CHIP	120K 5% 1/10W	*	1-705-409-11	SUB COMBINED BOARD	
R22	1-216-025-00	METAL CHIP	100 5% 1/10W			< CAPACITOR >	
R23	1-216-100-00	METAL GLAZE	130K 5% 1/10W	C201	1-163-986-00	CERAMIC CHIP 0.027uF 10% 25V	
R24	1-216-067-00	METAL CHIP	5.6K 5% 1/10W	C202	1-163-133-00	CERAMIC CHIP 470PF 5% 50V	
R25	1-249-430-11	CARBON	12K 5% 1/4W			(EXCEPT H170:G, IT)	
R31	1-216-033-00	METAL CHIP	220 5% 1/10W	C203	1-124-254-00	ELECT 0.68uF 20% 50V	
R32	1-216-033-00	METAL CHIP	220 5% 1/10W	C204	1-163-133-00	CERAMIC CHIP 470PF 5% 50V	
R41	1-249-393-11	CARBON	10 5% 1/4W	C205	1-124-257-00	ELECT 2.2uF 20% 50V	
R42	1-249-393-11	CARBON	10 5% 1/4W	C206	1-163-117-00	CERAMIC CHIP 100PF 5% 50V	
R51	1-216-075-00	METAL CHIP	12K 5% 1/10W			(EXCEPT H170:G, IT)	
R52	1-216-075-00	METAL CHIP	12K 5% 1/10W	C206	1-163-141-00	CERAMIC CHIP 0.001uF 5% 50V (H170:G, IT)	
R53	1-216-073-00	METAL CHIP	10K 5% 1/10W	C207	1-126-157-11	ELECT 10uF 20% 16V	
R54	1-216-309-00	METAL CHIP	5.6 5% 1/10W	C208	1-164-005-11	CERAMIC CHIP 0.47uF 25V	
R55	1-216-309-00	METAL CHIP	5.6 5% 1/10W	C209	1-124-257-00	ELECT 2.2uF 20% 50V	
R56	1-216-298-00	METAL CHIP	2.2 5% 1/10W	C301	1-163-986-00	CERAMIC CHIP 0.027uF 10% 25V	
R71	1-216-082-00	METAL GLAZE	24K 5% 1/10W	C302	1-163-133-00	CERAMIC CHIP 470PF 5% 50V	
R72	1-216-081-00	METAL CHIP	22K 5% 1/10W			(EXCEPT H170:G, IT)	
R73	1-216-089-00	METAL CHIP	47K 5% 1/10W	C303	1-124-254-00	ELECT 0.68uF 20% 50V	
R74	1-216-089-00	METAL CHIP	47K 5% 1/10W	C304	1-163-133-00	CERAMIC CHIP 470PF 5% 50V	
		< VARIABLE RESISTOR >		C305	1-124-257-00	ELECT 2.2uF 20% 50V	
RV11B	1-238-012-11	RES, ADJ, CARBON 1K (EXCEPT H170:EE)		C306	1-163-117-00	CERAMIC CHIP 100PF 5% 50V	
RV11B	1-241-627-11	RES, ADJ, CARBON 1K (H170:EE)				(EXCEPT H170:G, IT)	
RV12	1-238-551-11	RES, ADJ, CARBON 220K		C306	1-163-141-00	CERAMIC CHIP 0.001uF 5% 50V (H170:G, IT)	
RV21B	1-238-012-11	RES, ADJ, CARBON 1K (EXCEPT H170:EE)		C307	1-126-157-11	ELECT 10uF 20% 16V	
RV21B	1-241-627-11	RES, ADJ, CARBON 1K (H170:EE)		C308	1-164-005-11	CERAMIC CHIP 0.47uF 25V	
				C309	1-124-257-00	ELECT 2.2uF 20% 50V	

**SUB** (including POWER TRANSFORMER/VOLUME/MIC HP/SW)

Ref. No.	Part No.	Description	Remarks	Ref. No.	Part No.	Description	Remarks
C401	1-126-933-11	ELECT	100uF 20% 16V	C628	1-124-903-11	ELECT	1uF 20% 50V(H170K)
C402	1-163-038-00	CERAMIC CHIP	0.1uF 25V	C629	1-163-009-11	CERAMIC CHIP	0.001uF 10% 50V(H170K)
C403	1-163-038-00	CERAMIC CHIP	0.1uF 25V	C630	1-124-903-11	ELECT	1uF 20% 50V(H170K)
C404	1-124-443-00	ELECT	100uF 20% 10V	C631	1-164-232-11	CERAMIC CHIP	0.01uF 50V
C405	1-124-443-00	ELECT	100uF 20% 10V	C632	1-163-009-00	CERAMIC CHIP	0.001uF 5% 50V(H170:G, IT)
C407	1-124-257-00	ELECT	2.2uF 20% 50V	C632	1-163-117-00	CERAMIC CHIP	100PF 5% 50V (EXCEPT H170:G, IT)
C408	1-163-117-00	CERAMIC CHIP	100PF 5% 50V	C633	1-163-005-11	CERAMIC CHIP	470PF 10% 50V (EXCEPT H170:G, IT)
C409	1-164-489-11	CERAMIC CHIP	0.22uF 16V	C633	1-164-232-11	CERAMIC CHIP	0.01uF 5% 50V(H170:G, IT)
C410	1-164-489-11	CERAMIC CHIP	0.22uF 16V	C634	1-163-009-00	CERAMIC CHIP	0.001uF 10% 50V(H170:G, IT)
C411	1-163-141-00	CERAMIC CHIP	0.001uF 5% 50V	C635	1-164-232-11	CERAMIC CHIP	0.01uF 10% 50V(H170:G, IT)
C412	1-124-903-11	ELECT	1uF 20% 50V	C636	1-126-157-11	ELECT	10uF 20% 16V
C413	1-124-443-00	ELECT	100uF 20% 10V	C637	1-163-117-00	CERAMIC CHIP	100PF 5% 50V
C414	1-124-443-00	ELECT	100uF 20% 10V	C638	1-126-101-11	ELECT	100uF 20% 16V
C415	1-163-038-00	CERAMIC CHIP	0.1uF 25V	C639	1-126-157-11	ELECT	10uF 20% 16V
C416	1-163-038-00	CERAMIC CHIP	0.1uF 25V	C640	1-164-232-11	CERAMIC CHIP	0.01uF 50V
C417	1-124-482-11	ELECT	33uF 20% 35V	C641	1-164-232-11	CERAMIC CHIP	0.01uF 50V(H170K)
C419	1-126-926-11	ELECT	1000uF 20% 10V	C681	1-164-232-11	CERAMIC CHIP	0.01uF 50V
C420	1-163-038-00	CERAMIC CHIP	0.1uF 25V	C682	1-163-009-00	CERAMIC CHIP	0.001uF 10% 50V(H170:G, IT)
C421	1-163-117-00	CERAMIC CHIP	100PF 5% 50V	C682	1-163-117-00	CERAMIC CHIP	100PF 5% 50V (EXCEPT H170:G, IT)
C422	1-163-117-00	CERAMIC CHIP	100PF 5% 50V	C683	1-163-005-11	CERAMIC CHIP	470PF 10% 50V (EXCEPT H170:G, IT)
C424	1-163-133-00	CERAMIC CHIP	470PF 5% 50V	C683	1-164-232-11	CERAMIC CHIP	0.01uF 50V(H170:G, IT)
C425	1-163-133-00	CERAMIC CHIP	470PF 5% 50V	C684	1-163-009-00	CERAMIC CHIP	0.001uF 10% 50V(H170: G, IT)
C426	1-124-478-11	ELECT	100uF 20% 25V	C686	1-126-157-11	ELECT	10uF 20% 16V
C427	1-124-478-11	ELECT	100uF 20% 25V	C687	1-163-117-00	CERAMIC CHIP	100PF 5% 50V
C428	1-163-141-00	CERAMIC CHIP	0.001uF 5% 50V	C689	1-126-157-11	ELECT	10uF 20% 16V
C429	1-126-926-11	ELECT	1000uF 20% 10V	C691	1-124-604-00	ELECT	330uF 20% 10V
C603	1-164-004-11	CERAMIC CHIP	0.1uF 10% 25V(H170K)	C692	1-124-604-00	ELECT	330uF 20% 10V
C604	1-126-101-11	ELECT	100uF 20% 16V(H170K)	C4001	1-164-232-11	CERAMIC CHIP	0.01uF 50V
C605	1-126-101-11	ELECT	100uF 20% 16V(H170K)	C4002	1-164-232-11	CERAMIC CHIP	0.01uF 50V
C606	1-164-004-11	CERAMIC CHIP	0.1uF 10% 25V(H170K)	C4003	1-164-005-11	CERAMIC CHIP	0.47uF 25V
C607	1-124-589-11	ELECT	47uF 20% 16V(H170K)	< CONNECTOR >			
C608	1-163-017-00	CERAMIC CHIP	0.0047uF 5% 50V(H170K)	CN402	1-573-101-11	SOCKET, CONNECTOR 9P	
C609	1-124-611-00	ELECT	1uF 20% 50V(H170K)	CN403	1-580-783-11	CONNECTOR, BOARD TO BOARD	
C610	1-163-018-00	CERAMIC CHIP	0.0056uF 5% 50V(H170K)	CN404	1-573-101-11	SOCKET, CONNECTOR 9P	
C611	1-124-903-11	ELECT	1uF 20% 50V(H170K)	CN405	1-580-783-11	CONNECTOR, BOARD TO BOARD	
C612	1-164-232-11	CERAMIC CHIP	0.01uF 50V(H170K)	CN406	1-580-783-11	CONNECTOR, BOARD TO BOARD	
C613	1-163-010-11	CERAMIC CHIP	0.0012uF 10% 50V(H170K)	* CN407	1-566-970-11	HOUSING, CONNECTOR(PC BOARD)8P	
C614	1-124-903-11	ELECT	1uF 20% 50V(H170K)	* CN408	1-566-970-11	HOUSING, CONNECTOR(PC BOARD)8P	
C615	1-163-018-00	CERAMIC CHIP	0.0056uF 5% 50V(H170K)	CN410	1-695-068-21	CONNECTOR, FFC/FPC 15P	
C617	1-164-004-11	CERAMIC CHIP	0.1uF 10% 25V(H170K)	* CN601	1-568-454-11	PIN, CONNECTOR (PC BOARD) 9P	
C618	1-164-004-11	CERAMIC CHIP	0.1uF 10% 25V(H170K)	* CN602	1-573-100-11	SOCKET, CONNECTOR 4P	
C619	1-164-004-11	CERAMIC CHIP	0.1uF 10% 25V(H170K)	* CN851	1-564-321-00	PIN, CONNECTOR 2P	
C620	1-164-232-11	CERAMIC CHIP	0.01uF 50V(H170K)	* CN852	1-569-508-11	PIN, CONNECTOR 8P	
C621	1-164-004-11	CERAMIC CHIP	0.1uF 10% 25V(H170K)	* CN1501	1-691-894-12	CONNECTOR, FFC/FPC 15P	
C622	1-164-232-11	CERAMIC CHIP	0.01uF 50V(H170K)				
C623	1-163-117-00	CERAMIC CHIP	100PF 5% 50V				
C624	1-124-903-11	ELECT	1uF 20% 50V				
C625	1-163-009-11	CERAMIC CHIP	0.001uF 10% 50V				
C626	1-124-903-11	ELECT	1uF 20% 50V				
C627	1-163-117-00	CERAMIC CHIP	100PF 5% 50V(H170K)				

**SUB** (including POWER TRANSFORMER/VOLUME/MIC HP/SW)

Ref. No.	Part No.	Description	Remarks	Ref. No.	Part No.	Description	Remarks
< DIODE >				< TRANSISTOR >			
D401	8-719-210-33	DIODE EC10DS2		Q201	8-729-900-80	TRANSISTOR DTC114ES	
D403	8-719-801-78	DIODE 1SS184		Q202	8-729-620-05	TRANSISTOR 2SC2603-EF	
D404	8-719-021-41	DIODE UZM5.6X		Q301	8-729-900-80	TRANSISTOR DTC114ES	
D405	8-719-021-77	DIODE UZM8.2Z		Q302	8-729-620-05	TRANSISTOR 2SC2603-EF	
D407	8-719-801-78	DIODE 1SS184		Q401	8-729-804-41	TRANSISTOR 2SB1122-S	
D410	8-719-801-78	DIODE 1SS184		Q402	8-729-804-41	TRANSISTOR 2SB1122-S	
D411	8-719-820-05	DIODE 1SS181		Q403	8-729-900-61	TRANSISTOR DTA114ES	
D412	8-719-801-78	DIODE 1SS184		Q404	8-729-900-80	TRANSISTOR DTC114ES	
D414	8-719-210-33	DIODE EC10DS2		Q405	8-729-900-61	TRANSISTOR DTA114ES	
D416	8-719-801-78	DIODE 1SS184		Q406	8-729-900-61	TRANSISTOR DTA114ES	
D601	8-719-303-65	DIODE SEL4510-D (H170K)		Q407	8-729-900-61	TRANSISTOR DTA114ES	
D602	8-719-303-65	DIODE SEL4510-D (H170K)		Q408	8-729-900-80	TRANSISTOR DTC114ES	
D810	8-719-312-09	DIODE RBA-40Z		Q409	8-729-900-65	TRANSISTOR DTA144ES	
D1501	8-719-026-66	DIODE SML1460E		Q410	8-729-900-65	TRANSISTOR DTA144ES	
D1502	8-719-026-66	DIODE SML1460E		Q411	8-729-900-80	TRANSISTOR DTC114ES	
D1503	8-719-026-64	DIODE SML1260S		Q412	8-729-900-61	TRANSISTOR DTA114ES	
D1504	8-719-026-64	DIODE SML1260S		Q413	8-729-900-80	TRANSISTOR DTC114ES	
D1506	8-719-026-64	DIODE SML1260S		Q414	8-729-900-80	TRANSISTOR DTC114ES	
D1507	8-719-026-66	DIODE SML1460E		Q415	8-729-900-61	TRANSISTOR DTA114ES	
D1508	8-719-026-66	DIODE SML1460E		Q602	8-729-620-05	TRANSISTOR 2SC2603-EF	
D1509	8-719-026-64	DIODE SML1260S		Q603	8-729-620-05	TRANSISTOR 2SC2603-EF (H170K)	
D4001	8-719-801-78	DIODE 1SS184		< RESISTOR >			
< FUSE >				R201	1-216-089-00	METAL CHIP 47K 5% 1/10W	
△F801	1-532-078-00	FUSE (1A)		R202	1-216-089-00	METAL CHIP 47K 5% 1/10W	
△F801	1-532-203-00	FUSE (2A) (H170:E, EA, H170K)		R203	1-216-057-00	METAL CHIP 2.2K 5% 1/10W	
△F802	1-532-078-00	FUSE (1A) (H170:E, EA, H170K)		R204	1-216-063-00	METAL CHIP 3.9K 5% 1/10W	
< IC >				R205	1-216-105-00	METAL CHIP 220K 5% 1/10W	
IC201	8-759-300-71	IC TC4053BCM		R206	1-216-025-00	METAL CHIP 100 5% 1/10W	
IC202	8-752-050-13	IC CXA1101M		R207	1-216-057-00	METAL CHIP 2.2K 5% 1/10W	
IC203	8-759-996-43	IC RC4558PS		R208	1-216-105-00	METAL CHIP 220K 5% 1/10W	
IC204	8-759-516-47	IC CD4066BCM		R209	1-216-097-00	METAL CHIP 100K 5% 1/10W	
IC205	8-752-055-60	IC CXA1578M		R210	1-216-066-00	METAL CHIP 5.1K 5% 1/10W	
IC401	8-759-061-36	IC M50964-30Z		R211	1-216-025-00	METAL CHIP 100 5% 1/10W	
IC402	8-759-207-05	IC TA7272P		R212	1-216-057-00	METAL CHIP 2.2K 5% 1/10W	
IC403	8-759-996-43	IC RC4558PS		R213	1-216-081-00	METAL CHIP 22K 5% 1/10W	
IC404	8-759-916-25	IC SN74HC32AN		R214	1-216-089-00	METAL CHIP 47K 5% 1/10W	
IC405	8-759-520-90	IC PST572E		R215	1-216-061-00	METAL CHIP 3.3K 5% 1/10W	
IC601	8-759-636-22	IC M50197FP (H170K)		R301	1-216-089-00	METAL CHIP 47K 5% 1/10W	
IC602	8-759-636-55	IC M5218AFP		R302	1-216-089-00	METAL CHIP 47K 5% 1/10W	
< JACK >				R303	1-216-057-00	METAL CHIP 2.2K 5% 1/10W	
J601	1-562-837-21	JACK (HEADPHONES)		R304	1-216-063-00	METAL CHIP 3.9K 5% 1/10W	
J602	1-562-837-21	JACK (MIC1)		R305	1-216-105-00	METAL CHIP 220K 5% 1/10W	
J603	1-562-837-21	JACK (MIC2) (H170K)		R306	1-216-025-00	METAL CHIP 100 5% 1/10W	
< COIL >				R307	1-216-057-00	METAL CHIP 2.2K 5% 1/10W	
L403	1-410-482-31	INDUCTOR 100uH		R308	1-216-105-00	METAL CHIP 220K 5% 1/10W	
L404	1-410-482-31	INDUCTOR 100uH		R309	1-216-097-00	METAL CHIP 100K 5% 1/10W	
				R310	1-216-066-00	METAL CHIP 5.1K 5% 1/10W	



**SUB** (including POWER TRANSFORMER/VOLUME/MIC HP/SW)

Ref. No.	Part No.	Description	Remarks	Ref. No.	Part No.	Description	Remarks
R311	1-216-025-00	METAL CHIP	100 5% 1/10W	R449	1-216-113-00	METAL CHIP	470K 5% 1/10W
R312	1-216-057-00	METAL CHIP	2.2K 5% 1/10W	R450	1-216-057-00	METAL CHIP	2.2K 5% 1/10W
R313	1-216-081-00	METAL CHIP	22K 5% 1/10W	R451	1-216-097-00	METAL CHIP	100K 5% 1/10W
R314	1-216-089-00	METAL CHIP	47K 5% 1/10W	R452	1-216-097-00	METAL CHIP	100K 5% 1/10W
R315	1-216-065-00	METAL CHIP	3.3K 5% 1/10W	R453	1-216-065-00	METAL CHIP	4.7K 5% 1/10W
R401	1-216-037-00	METAL CHIP	330 5% 1/10W	R454	1-216-097-00	METAL CHIP	100K 5% 1/10W
R402	1-216-037-00	METAL CHIP	330 5% 1/10W	R455	1-216-089-00	METAL CHIP	47K 5% 1/10W
R403	1-216-037-00	METAL CHIP	330 5% 1/10W	R456	1-216-089-00	METAL CHIP	47K 5% 1/10W
R404	1-216-057-00	METAL CHIP	2.2K 5% 1/10W	R457	1-216-089-00	METAL CHIP	47K 5% 1/10W
R405	1-216-057-00	METAL CHIP	2.2K 5% 1/10W	R458	1-216-088-00	METAL CHIP	43K 5% 1/10W
R406	1-216-113-00	METAL CHIP	470K 5% 1/10W	R459	1-216-089-00	METAL CHIP	47K 5% 1/10W
R407	1-216-113-00	METAL CHIP	470K 5% 1/10W	R460	1-216-065-00	METAL CHIP	4.7K 5% 1/10W
R408	1-216-073-00	METAL CHIP	10K 5% 1/10W	R461	1-216-081-00	METAL CHIP	22K 5% 1/10W
R409	1-216-073-00	METAL CHIP	10K 5% 1/10W	R462	1-216-082-00	METAL GLAZE	24K 5% 1/10W
R410	1-216-045-00	METAL CHIP	680 5% 1/10W	R463	1-216-073-00	METAL CHIP	10K 5% 1/10W
R411	1-216-037-00	METAL CHIP	330 5% 1/10W	R464	1-216-073-00	METAL CHIP	10K 5% 1/10W
R412	1-216-073-00	METAL CHIP	10K 5% 1/10W	R466	1-216-025-00	METAL CHIP	100 5% 1/10W
R413	1-216-045-00	METAL CHIP	680 5% 1/10W	R467	1-216-025-00	METAL CHIP	100 5% 1/10W
R414	1-216-073-00	METAL CHIP	10K 5% 1/10W	R470	1-216-073-00	METAL CHIP	10K 5% 1/10W
R415	1-216-083-00	METAL CHIP	27K 5% 1/10W	R471	1-216-073-00	METAL CHIP	10K 5% 1/10W
R416	1-216-073-00	METAL CHIP	10K 5% 1/10W	R472	1-216-073-00	METAL CHIP	10K 5% 1/10W
R417	1-216-083-00	METAL CHIP	27K 5% 1/10W	R473	1-216-073-00	METAL CHIP	10K 5% 1/10W
R418	1-216-085-00	METAL CHIP	33K 5% 1/10W	R474	1-216-073-00	METAL CHIP	10K 5% 1/10W
R419	1-216-084-00	METAL CHIP	30K 5% 1/10W	R475	1-216-065-00	METAL CHIP	4.7K 5% 1/10W
R420	1-216-089-00	METAL CHIP	47K 5% 1/10W	R601	1-216-073-00	METAL CHIP	10K 5% 1/10W(H170K)
R421	1-216-065-00	METAL CHIP	4.7K 5% 1/10W	R602	1-216-077-00	METAL CHIP	15K 5% 1/10W(H170K)
R422	1-216-090-00	METAL CHIP	51K 5% 1/10W	R603	1-216-077-00	METAL CHIP	15K 5% 1/10W(H170K)
R423	1-216-080-00	METAL CHIP	20K 5% 1/10W	R604	1-216-083-00	METAL CHIP	27K 5% 1/10W(H170K)
R424	1-216-090-00	METAL CHIP	51K 5% 1/10W	R605	1-216-060-00	METAL GLAZE	3K 5% 1/10W(H170K)
R425	1-216-025-00	METAL CHIP	100 5% 1/10W	R606	1-216-059-00	METAL CHIP	2.7K 5% 1/10W(H170K)
R426	1-216-065-00	METAL CHIP	4.7K 5% 1/10W	R607	1-216-077-00	METAL CHIP	15K 5% 1/10W(H170K)
R427	1-216-085-00	METAL CHIP	33K 5% 1/10W	R608	1-216-077-00	METAL CHIP	15K 5% 1/10W(H170K)
R428	1-216-089-00	METAL CHIP	47K 5% 1/10W	R609	1-216-073-00	METAL CHIP	10K 5% 1/10W(H170K)
R429	1-216-090-00	METAL CHIP	51K 5% 1/10W	R610	1-216-070-00	METAL CHIP	7.5K 5% 1/10W(H170K)
R430	1-216-084-00	METAL CHIP	30K 5% 1/10W	R611	1-216-094-00	METAL GLAZE	75K 5% 1/10W(H170K)
R431	1-216-080-00	METAL CHIP	20K 5% 1/10W	R612	1-216-070-00	METAL CHIP	7.5K 5% 1/10W(H170K)
R432	1-216-090-00	METAL CHIP	51K 5% 1/10W	R613	1-216-094-00	METAL GLAZE	75K 5% 1/10W(H170K)
R433	1-216-025-00	METAL CHIP	100 5% 1/10W	R616	1-216-045-00	METAL CHIP	680 5% 1/10W
R434	1-216-121-00	METAL CHIP	1M 5% 1/10W	R617	1-216-121-00	METAL CHIP	1M 5% 1/10W
R435	1-216-073-00	METAL CHIP	10K 5% 1/10W	R618	1-216-060-00	METAL GLAZE	3K 5% 1/10W
R436	1-216-065-00	METAL CHIP	4.7K 5% 1/10W	R619	1-216-025-00	METAL CHIP	100 5% 1/10W
R437	1-216-073-00	METAL CHIP	10K 5% 1/10W	R620	1-216-045-00	METAL CHIP	680 5% 1/10W (H170K)
R438	1-216-073-00	METAL CHIP	10K 5% 1/10W	R621	1-216-121-00	METAL CHIP	1M 5% 1/10W (H170K)
R440	1-216-057-00	METAL CHIP	2.2K 5% 1/10W	R622	1-216-060-00	METAL GLAZE	3K 5% 1/10W (H170K)
R441	1-216-041-00	METAL CHIP	470 5% 1/10W	R623	1-216-025-00	METAL CHIP	100 5% 1/10W (H170K)
R444	1-216-073-00	METAL CHIP	10K 5% 1/10W	R624	1-216-121-00	METAL CHIP	1M 5% 1/10W (H170K)
R445	1-216-073-00	METAL CHIP	10K 5% 1/10W	R626	1-216-049-00	METAL CHIP	1K 5% 1/10W
R446	1-216-097-00	METAL CHIP	100K 5% 1/10W	R627	1-216-089-00	METAL CHIP	47K 5% 1/10W
R447	1-216-065-00	METAL CHIP	4.7K 5% 1/10W	R628	1-216-063-00	METAL CHIP	3.9K 5% 1/10W
R448	1-216-089-00	METAL CHIP	47K 5% 1/10W	R629	1-216-089-00	METAL CHIP	47K 5% 1/10W

**SUB** (including POWER TRANSFORMER/VOLUME/MIC HP/SW)

Ref. No.	Part No.	Description	Remarks	Ref. No.	Part No.	Description	Remarks
R630	1-216-017-00	METAL CHIP	47 5% 1/10W	R4005	1-216-298-00	METAL CHIP	2.2 5% 1/10W
R632	1-216-097-00	METAL CHIP	100K 5% 1/10W	R4006	1-216-298-00	METAL CHIP	2.2 5% 1/10W
R633	1-216-097-00	METAL CHIP	100K 5% 1/10W (H170K)	R4007	1-216-298-00	METAL CHIP	2.2 5% 1/10W
R634	1-216-035-00	METAL CHIP	270 5% 1/10W	R4008	1-216-298-00	METAL CHIP	2.2 5% 1/10W
R635	1-216-089-00	METAL CHIP	47K 5% 1/10W	△R4009	1-212-849-00	FUSIBLE	4.7 5% 1/4W F
R636	1-216-089-00	METAL CHIP	47K 5% 1/10W (H170K)	△R4010	1-212-849-00	FUSIBLE	4.7 5% 1/4W F
R637	1-216-105-00	METAL CHIP	220K 5% 1/10W	R4099	1-249-390-11	CARBON	5.6 5% 1/6W
R676	1-216-049-00	METAL CHIP	1K 5% 1/10W	R4421	1-216-049-00	METAL CHIP	1K 5% 1/10W
R677	1-216-089-00	METAL CHIP	47K 5% 1/10W			< VARIABLE RESISTOR >	
R678	1-216-063-00	METAL CHIP	3.9K 5% 1/10W	RV201	1-241-136-11	RES, ADJ, CARBON 10K	
R679	1-216-089-00	METAL CHIP	47K 5% 1/10W	RV301	1-241-136-11	RES, ADJ, CARBON 10K	
R687	1-216-105-00	METAL CHIP	220K 5% 1/10W			< SWITCH >	
R688	1-216-017-00	METAL CHIP	47 5% 1/10W	S1022	1-572-184-11	SWITCH, KEYBOARD (CONTINUE)	
△R831	1-219-119-11	FUSIBLE	0.1 5% 1/4W F	S1501	1-572-184-11	SWITCH, KEYBOARD (▲)	
△R881	1-219-119-11	FUSIBLE	0.1 5% 1/4W F	S1502	1-572-184-11	SWITCH, KEYBOARD (▶■■)	
R1028	1-216-057-00	METAL CHIP	2.2K 5% 1/10W	S1503	1-572-184-11	SWITCH, KEYBOARD (■)	
R1501	1-216-041-00	METAL CHIP	470 5% 1/10W	S1504	1-572-184-11	SWITCH, KEYBOARD (▶▶)	
R1502	1-216-045-00	METAL CHIP	680 5% 1/10W	S1505	1-572-184-11	SWITCH, KEYBOARD (◀◀)	
R1503	1-216-049-00	METAL CHIP	1K 5% 1/10W	S1506	1-572-184-11	SWITCH, KEYBOARD (REPEAT)	
R1504	1-216-053-00	METAL CHIP	1.5K 5% 1/10W	S1507	1-572-184-11	SWITCH, KEYBOARD (PROGRAM)	
R1505	1-216-057-00	METAL CHIP	2.2K 5% 1/10W	S1508	1-572-184-11	SWITCH, KEYBOARD (SHUFFLE)	
R1506	1-216-065-00	METAL CHIP	4.7K 5% 1/10W	S1509	1-572-184-11	SWITCH, KEYBOARD (EDIT/TIME/FADE)	
R1507	1-216-075-00	METAL CHIP	12K 5% 1/10W	S1510	1-572-184-11	SWITCH, KEYBOARD (CHECK)	
R1508	1-216-065-00	METAL CHIP	4.7K 5% 1/10W	S1511	1-572-184-11	SWITCH, KEYBOARD (■)	
R1509	1-216-075-00	METAL CHIP	12K 5% 1/10W	S1512	1-572-184-11	SWITCH, KEYBOARD (PAUSE)	
R1510	1-216-029-00	METAL CHIP	150 5% 1/10W	S1513	1-572-184-11	SWITCH, KEYBOARD (▷)	
R1511	1-216-033-00	METAL CHIP	220 5% 1/10W	S1514	1-572-184-11	SWITCH, KEYBOARD (◁)	
R1512	1-216-037-00	METAL CHIP	330 5% 1/10W	S1516	1-572-184-11	SWITCH, KEYBOARD (◀◀)	
R1513	1-216-041-00	METAL CHIP	470 5% 1/10W	S1517	1-572-184-11	SWITCH, KEYBOARD (▶▶)	
R1514	1-216-045-00	METAL CHIP	680 5% 1/10W	S1518	1-572-184-11	SWITCH, KEYBOARD (■)	
R1515	1-216-049-00	METAL CHIP	1K 5% 1/10W	S1519	1-572-184-11	SWITCH, KEYBOARD (▷)	
R1517	1-216-075-00	METAL CHIP	12K 5% 1/10W	S1520	1-572-184-11	SWITCH, KEYBOARD (◁)	
R1518	1-216-067-00	METAL CHIP	5.6K 5% 1/10W	S1521	1-572-184-11	SWITCH, KEYBOARD (◀◀)	
R1519	1-216-029-00	METAL CHIP	150 5% 1/10W	S1522	1-572-184-11	SWITCH, KEYBOARD (▶▶)	
R1520	1-216-033-00	METAL CHIP	220 5% 1/10W	S1523	1-572-184-11	SWITCH, KEYBOARD (REC)	
R1521	1-216-037-00	METAL CHIP	330 5% 1/10W	S1524	1-572-184-11	SWITCH, KEYBOARD (HIGH SPEED)	
R1522	1-216-041-00	METAL CHIP	470 5% 1/10W	S1525	1-572-184-11	SWITCH, KEYBOARD (CD SYNC)	
R1523	1-216-045-00	METAL CHIP	680 5% 1/10W	S1526	1-572-378-11	SWITCH, SLIDE (DIRECTION MODE)	
R1524	1-216-049-00	METAL CHIP	1K 5% 1/10W	S1527	1-572-347-31	SWITCH, SLIDE (DOLBY NR)	
R1525	1-216-067-00	METAL CHIP	5.6K 5% 1/10W	△VS801	1-572-675-11	SWITCH, POWER VOLTAGE CHANGE (H170:E, EA/H170K)	
R1526	1-216-029-00	METAL CHIP	150 5% 1/10W			< TEST PIN >	
R1527	1-216-029-00	METAL CHIP	150 5% 1/10W	* TP101	1-564-520-11	PLUG, CONNECTOR 5P	
R1530	1-216-029-00	METAL CHIP	150 5% 1/10W	* TP401	1-564-517-11	PLUG, CONNECTOR 2P	
R1531	1-216-029-00	METAL CHIP	150 5% 1/10W				
R2001	1-216-073-00	METAL CHIP	10K 5% 1/10W				
R4000	1-216-049-00	METAL CHIP	1K 5% 1/10W				
R4001	1-216-298-00	METAL CHIP	2.2 5% 1/10W				
R4002	1-216-298-00	METAL CHIP	2.2 5% 1/10W				
R4003	1-216-298-00	METAL CHIP	2.2 5% 1/10W				
R4004	1-216-298-00	METAL CHIP	2.2 5% 1/10W				

**Note:** The components identified by mark △ or dotted line with mark △ are critical for safety. Replace only with part number specified.

**SUB** (including POWER TRANSFORMER/VOLUME/MIC HP/SW)

Ref. No.	Part No.	Description	Remarks	Ref. No.	Part No.	Description	Remarks
< VIBRATOR >							
X401	1-567-819-31	VIBRATOR, CERAMIC 4MHz					
X601	1-567-819-11	VIBRATOR, CERAMIC 4MHz (H170K)					
*****							
MISCELLANEOUS							
*****							
55	1-690-854-21	WIRE (FLAT TYPE) (16 CORE) (EXCEPT H700:UK)					
△T101	1-450-769-11	TRANSFORMER, POWER (H170:AEP, EE, G, IT/H700)					
△T101	1-450-770-11	TRANSFORMER, POWER (H170:E, EA, AUS/H170K)					
6	1-533-213-31	HOLDER, FUSE					
55	1-690-854-31	WIRE (FLAT TYPE) (16 CORE) (H700:UK)					
58	1-690-996-11	WIRE (FLAT TYPE) (4 CORE)					
* 59	1-590-240-11	WIRE, FLAT TYPE (9 CORE)					
60	1-690-997-11	CABLE, FLAT (11 CORE)					
61	1-690-588-31	WIRE, FLAT TYPE (9 CORE)					
△64	1-574-804-11	CORD, POWER (H700:UK)					
△64	1-590-042-11	CORD, POWER (WITH CORD) (H170:G, IT)					
△64	1-574-805-11	CORD, POWER (H170:AEP, EA/H170K:EA/H700)					
△64	1-574-902-11	CORD, POWER (H170:E/H170K:E)					
△64	1-690-056-11	CORD, POWER (H170:AUS)					
△64	1-696-169-11	CORD, POWER (H170:EE)					
167	1-638-983-11	PC BOARD, MOTOR FLEXIBLE					
253	1-590-530-11	WIRE, FLAT TYPE					
264	1-690-853-11	WIRE (FLAT TYPE) (19 CORE)					
△305	8-848-144-11	DEVICE, OPTICAL KSS-240A					
307	1-575-001-11	WIRE, FLAT TYPE (12 CORE)					
ANT1	1-501-321-61	ANTENNA, TELESCOPIC (H170/H170K)					
HP101	A-2003-868-A	BASE ASSY, HEAD					
HRP101	A-2003-838-A	BASE ASSY, HEAD					
M101	X-4917-504-1	MOTOR ASSY (SLED)					
M101A	X-3363-501-1	MOTOR ASSY, REEL (DECK A)					
M101B	X-3363-501-1	MOTOR ASSY, REEL (DECK B)					
M102	X-4917-523-3	MOTOR ASSY (SPINDLE)					
M102A	X-3359-417-1	MOTOR (CAPSTAN MOTOR) ASSY (DECK A)					
M102B	X-3359-417-1	MOTOR (CAPSTAN MOTOR) ASSY (DECK B)					
M251	A-4608-362-A	MOTOR (L) ASSY					
*****							
				ACCESSORIES & PACKING MATERIALS			
				*****			
				1-501-369-11 ANTENNA (H700:UK)			
				1-501-374-11 ANTENNA, LOOP (H700:UK)			
				1-693-057-11 COMMANDER, STANDARD (RM-S150)			
				3-701-630-00 BAG, POLYETHYLENE (H700:UK)			
				3-755-073-11 MANUAL, INSTRUCTION (ENGLISH, FRENCH, SPANISH, CHINESE, DUTCH) (H700:UK)			
*	4-941-548-01	LABEL, CLASS 1 (H170/H170K/H700:AEP)		*	4-941-548-01	LABEL, CLASS 1 (H170/H170K/H700:AEP)	
*	4-951-410-01	INDIVIDUAL CARTON (H700:UK)		*	4-951-410-01	INDIVIDUAL CARTON (H700:UK)	
*	4-951-934-01	CUSHION, UPPER		*	4-951-934-01	CUSHION, UPPER	
*	4-951-935-01	CUSHION, LOWER		*	4-951-935-01	CUSHION, LOWER	
	4-952-050-01	LABEL, MODEL NUMBER (AE) (H700:AEP)			4-952-050-01	LABEL, MODEL NUMBER (AE) (H700:AEP)	
	4-952-381-01	LABEL, MODEL NUMBER (AU) (H170:AUS)			4-952-381-01	LABEL, MODEL NUMBER (AU) (H170:AUS)	
				*****			
				*****			
				<b>HARDWARE LIST</b>			
				*****			
	#1	7-682-547-04	SCREW +BVTT 3X6 (S)		#1	7-682-547-04	SCREW +BVTT 3X6 (S)
	#2	7-685-649-79	SCREW +BVTP 3X14 TYPE2 IT-3		#2	7-685-649-79	SCREW +BVTP 3X14 TYPE2 IT-3
	#3	7-685-647-79	SCREW +BVTP 3X10 TYPE2 N-S		#3	7-685-647-79	SCREW +BVTP 3X10 TYPE2 N-S
	#4	7-682-549-09	SCREW +BVTT 3X10 (S) (H170/H170K)		#4	7-682-549-09	SCREW +BVTT 3X10 (S) (H170/H170K)
	#5	7-621-255-15	SCREW +PTT 2X3 (S)		#5	7-621-255-15	SCREW +PTT 2X3 (S)
	#6	7-621-770-67	SCREW +PTT 2.6X6 (S)		#6	7-621-770-67	SCREW +PTT 2.6X6 (S)
	#7	7-627-556-08	SCREW +P 2.6X2.8		#7	7-627-556-08	SCREW +P 2.6X2.8
	#8	7-621-775-00	SCREW +B 2.6X3		#8	7-621-775-00	SCREW +B 2.6X3
	#9	7-685-234-19	SCREW +KTP 2.6X8 TYPE2NON-SLIT		#9	7-685-234-19	SCREW +KTP 2.6X8 TYPE2NON-SLIT
	#10	7-685-646-79	SCREW +BVTP 3X8 TYPE2 N-S		#10	7-685-646-79	SCREW +BVTP 3X8 TYPE2 N-S
	#11	7-624-105-04	STOP RING 2.3, TYPE -E		#11	7-624-105-04	STOP RING 2.3, TYPE -E
	#12	7-621-775-10	SCREW +B 2.6X4		#12	7-621-775-10	SCREW +B 2.6X4
	#13	7-685-134-19	SCREW +BTP 2.6X8 TYPE2 N-S		#13	7-685-134-19	SCREW +BTP 2.6X8 TYPE2 N-S
	#14	7-685-136-19	SCREW +P 2.6X12 TYPE2 NON-SLIT (H170/H170K)		#14	7-685-136-19	SCREW +P 2.6X12 TYPE2 NON-SLIT (H170/H170K)

**Note:** The components identified by mark **△** or dotted line with mark **△** are critical for safety. Replace only with part number specified.