

AIWA®

DX-M80

SERVICE MANUAL

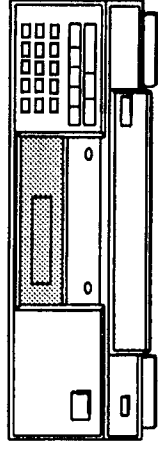

COMPACT DISC PLAYER

- BASIC CD MECHANISM: KSL-150ACM/B

- TYPE: Y,YK

- ◆ DX-M80 is the Compact Disc Player which is connected to CX-80/80M/81M only.

SPECIFICATIONS

Type:	Compact disc digital audio system
Disc:	Compact disc
Scanning method:	Non contact optical scanner (semiconductor laser application)
Laser:	Semiconductor laser (λ=780 nm)
Rotation speed:	Approx. 500 rpm - 200 rpm (CLV)
Error correction:	Cross Interleave, Reed Solomon code
No. of channels:	2 channel
D-A conversion:	16-bit linear
Wow/Flutter:	Unmeasurable
Frequency response:	10 Hz - 20 kHz, ±1 dB
Harmonic distortion:	0.015% (1 kHz, 0 dB)
Dynamic range:	92 dB
Channel separation:	84 dB (1 kHz, 0 dB)
S/N ratio:	96 dB (1 kHz)

Power and miscellaneous

Power supply:	Supplied from the main unit
Dimensions:	360 (W) × 122 (H) × 309 (D) mm
Weight:	3.5 kg

- Design and specifications are subject to change without notice.

AIWA Co., Ltd.

Tokyo Japan

Printed in Japan

CAUTIONS WHEN SERVICING

The DX-M80 has no power supply circuit. Power should be supplied from CX-80, CX-80M, CX-81M using an 11-core flat cable. During repair, connect DX-M80 to the CX-80, CX-80M, CX-81M to supply the power. When there is no CX-80, CX-80M, CX-81M, supply the power in the manner below.

(When repairing without CX-80, CX-80M, CX-81M)

1. Remove soldering from ② and ③ terminals of T51 not to flow DC through T51.
2. Connect the Multi-Power Supply(LPS-9088) in the manner below.

• FL501 does not light, as AC power for FL501 is not supplied.

A MAIN C.B

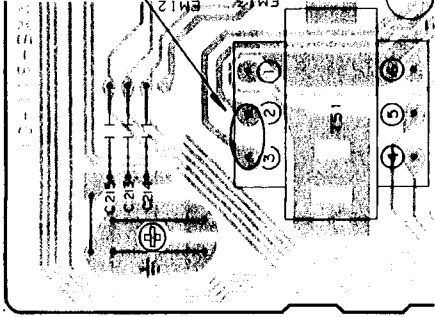

The voltages below are supplied to each CON101 terminal the external power source.

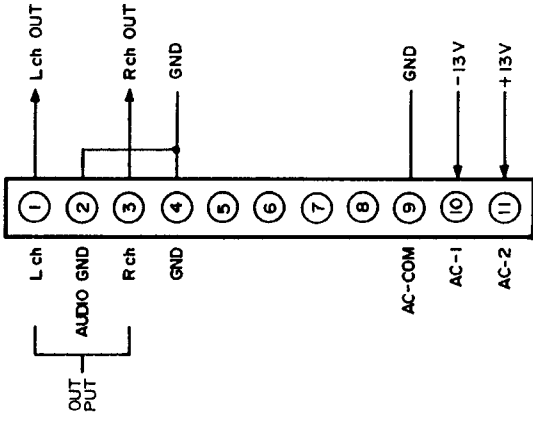

3. Multi-Power (LPS-9088) Connection

Connect to J1 of the LPS-9088 using a multi-conversion harness.

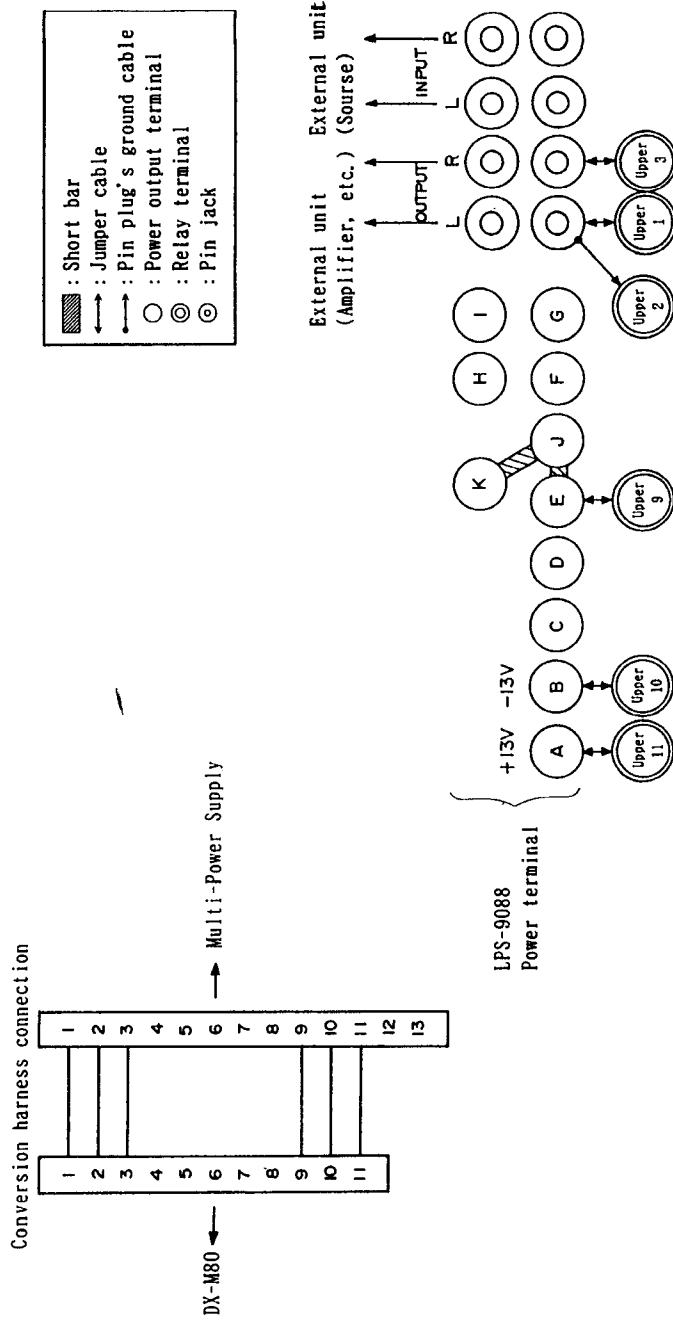

PROTECTION OF EYES FROM LASER BEAM DURING SERVICING

This set employs laser. Therefore, be sure to follow carefully the instructions below when servicing.

WARNING!!

WHEN SERVICING, DO NOT APPROACH THE LASER EXIT WITH THE EYE TOO CLOSELY. IN CASE IT IS NECESSARY TO CONFIRM LASER BEAM EMISSION, BE SURE TO OBSERVE FROM A DISTANCE OF MORE THAN 30cm FROM THE SURFACE OF THE OBJECTIVE LENS ON THE OPTICAL PICK-UP BLOCK.

CAUTION

Use of controls or adjustments or performance of procedures other than those specified herein may result in hazardous radiation exposure.

ATTENTION

L'utilisation de commandes, réglages ou procédures autres que ceux spécifiés peut entraîner une dangereuse exposition aux radiations.

"Varoitus! Suojakotelo ei saa avata. Laite sisältää laserdiodin, joka lähettää näkymätöntä silmille vaarallista laser säteilyä."

"Denna apparat innehåller laserkomponent som avger laserstrålning som överskrider gränsen för laserklass 1."

ADVARSEL!



Usynlig laserstrålning ved åbning, når sikkerhedsafbrydere er ude af funktion. Undgå udsættelse for strålning.

This Compact Disc player is classified as a CLASS 1 LASER product. The CLASS 1 LASER PRODUCT label is located on the rear exterior.



DISASSEMBLY INSTRUCTIONS

1. "Tray" Removal

- 1) Remove the "Cabinet, Steel".
- 2) ● For AUTOMATIC operation

Press the OPEN/CLOSE button to eject the "Tray".

● For MANUAL operation

Insert a flat-head screwdriver into the hole at the bottom of the set and turn the cam in the direction of the arrow to eject the "Tray". (See Figure-1)

- 3) Remove "MAIN C.B" and loosen 2 screws ③ and pull out the "Tray" toward you. (See Figure-2)

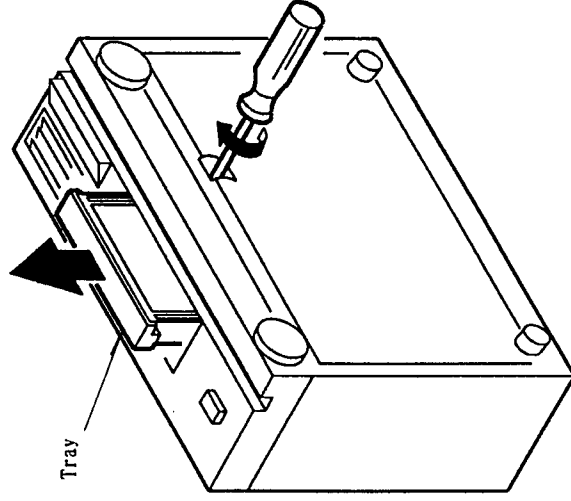

Fig. -1

2. "CD Mechanism" Removal

- 1) Remove 4 screws ① and remove "MAIN C. B".
- 2) Loosen 2 screws ②, remove 3 screws ③ and remove "CD Mechanism". (See Figure-2)

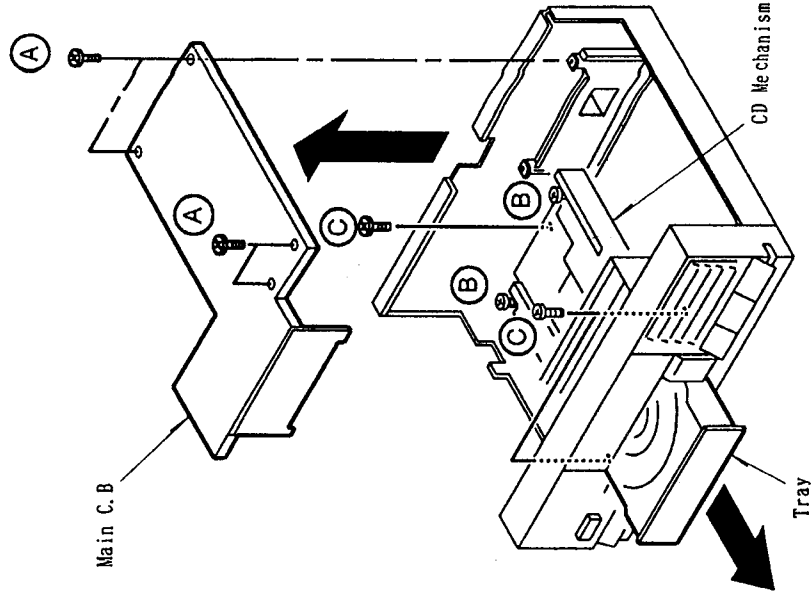

Fig. -2

ELECTRICAL MAIN PARTS LIST

REF. NO.	PART NO.	DESCRIPTION	REF. NO.	PART NO.	DESCRIPTION
===IC===					
87-001-184-010	IC, CXA1081S		C207	*87-018-127-010	CAP, CERA-SOL U 470P-50 B
87-020-794-010	IC, CXA1082BQ		C208	*87-018-127-019	CAP, CERA-SOL U 470P-50 B
87-020-795-010	IC, CXD11350		C209	*87-018-127-019	CAP, CERA-SOL U 470P-50 B
87-001-888-010	IC, CXC5816PN-12L		C210	*87-018-134-019	CAP, CERA-SOL U 0.01-16 Y
89-VX5-615-010	IC, CXP5058H-558Q		C211	*87-018-209-019	CAP, CERA-SOL U 0.1-50 F
87-001-196-019	IC, ICPN10		C212	*87-018-131-019	CAP, CERA-SOL U 1000P-50 B
87-001-132-019	IC, ICPN38		C213	*87-018-131-019	CAP, CERA-SOL U 100P-50 B
87-001-173-019	IC, LA6510		C214	*87-018-119-019	CAP, CERA-SOL U 100P-50 B
87-027-895-019	IC, M5218L		C215	*87-018-119-019	CAP, CERA-SOL U 1000P-50 B
87-027-986-019	IC, NJM4560SA		C351	*87-010-374-019	CAP, ELECT 47-10V
87-020-881-019	IC, NJM78L05A		C352	*87-018-134-019	CAP, CERA-SOL U 0.01-16 Y
87-001-169-010	IC, STA341M		C353	*87-018-111-019	CAP, CERA-SOL U 27P-50 SL
87-001-865-010	IC, TDA1543A		C354	*87-018-111-019	CAP, CERA-SOL U 27P-50 SL
===TRANSISTOR===			C355	*87-010-400-019	CAP, ELECT 0.47-50V SME
89-110-154-019	TRANSISTOR, 2SA1015Y		C357	*87-018-134-019	CAP, CERA-SOL U 0.01-16 Y
89-112-964-019	TRANSISTOR, 2SA1296Y		C359	*87-018-119-019	CAP, CERA-SOL U 1000P-50 B
89-213-702-019	TRANSISTOR, 2SB1370E		C360	*87-018-209-019	CAP, CERA-SOL U 0.1-50 F
89-318-155-019	TRANSISTOR, ZSC1815GR		C401	*87-018-132-019	CAP, CERA-SOL U 2200P-16 X
89-318-154-019	TRANSISTOR, ZSC1815Y		C402	*87-018-134-019	CAP, CERA-SOL U 0.01-16 Y
89-320-011-019	TRANSISTOR, ZSC2001K		C408	*87-010-404-019	CAP, ELECT 4.7-50V SME
89-420-612-019	TRANSISTOR, 2SD2061E		C410	*87-010-545-019	CAP, ELECT 0.22-50V SME
87-026-216-019	TRANSISTOR, DTA124ES		C411	*87-010-404-019	CAP, ELECT 4.7-50V SME
87-026-218-019	TRANSISTOR, DTC144ES		C413	*87-010-401-019	CAP, ELECT 1-50V SME
===DIODE===			C414	*87-010-404-019	CAP, ELECT 4.7-50V SME
87-027-376-019	DIODE 1B4B41		C415	*87-018-133-019	CAP, CERA-SOL U 4700P-16 X
87-001-559-019	DIODE 1SS131		C416	*87-010-382-019	CAP, ELECT 22-25V SME
87-020-110-019	DIODE 1SS177		C417	*87-010-263-019	CAP, ELECT 100-10V
87-027-451-019	DIODE, ZENER HZ27-2L		C418	*87-010-263-019	CAP, ELECT 100-10V
87-001-566-019	DIODE, ZENER HZ2B-1		C422	*87-018-205-019	CAP, CERA-SOL U 0.022-25 F
87-027-332-019	DIODE, ZENER HZ6B1L		C423	*87-018-209-019	CAP, CERA-SOL U 0.1-50 F
===MAIN CIRCUIT BOARD SECTION===			C424	*87-018-209-019	CAP, CERA-SOL SS 0.1
C1	*87-010-262-019	CAP, ELECT 3300-16V SME	C450	*87-018-209-019	CAP, CERA-SOL U 0.1-50 F
C2	*87-015-997-019	CAP, ELECT 2200-16V SME	C451	*87-018-132-019	CAP, CERA-SOL U 2200P-16 X
C3	*87-018-134-019	CAP, CERA-SOL U 0.01-16 Y	C453	*87-010-374-019	CAP, ELECT 47-10V
C4	*87-010-263-019	CAP, ELECT 100-10V SME	C457	*87-010-263-019	CAP, ELECT 100-10V
C5	*87-010-263-019	CAP, ELECT 100-10V SME	C458	*87-018-103-019	CAP, CERA-SOL SS 8.2P
C51	*87-010-247-019	CAP, ELECT 100-50V SME	C459	*87-010-793-019	CAP, ELECT BP 0.47-50V SRA
C53	*87-010-409-019	CAP, ELECT 220-50V SME	C460	*87-015-684-019	CAP, ELECT 47-25V
C54	*87-010-382-019	CAP, ELECT 22-25V SME	C461	*87-015-684-019	CAP, ELECT 47-25V
C55	*87-010-382-019	CAP, ELECT 22-25V SME	C462	*87-010-263-019	CAP, ELECT 100-10V
C101	*87-018-131-019	CAP, CERA-SOL U 1000P-50 B	C463	*87-010-374-019	CAP, ELECT 47-10V
C102	*87-018-131-019	CAP, CERA-SOL U 1000P-50 B	EMI1	*87-008-372-019	FILTER EMI BL O1RNI
C107	*87-010-405-019	CAP, ELECT 10-50V SME	EMI2	*87-008-372-019	FILTER EMI BL O1RNI
C108	*87-010-405-019	CAP, ELECT 10-50V SME	EMI3	*87-008-372-019	FILTER EMI BL O1RNI
C111	*87-014-039-019	CAP, PP 180P-100 J	EMI101	*87-008-372-019	FILTER EMI BL O1RNI
C112	*87-014-039-019	CAP, PP 180P-100 J	EMI102	*87-008-372-019	FILTER EMI BL O1RNI
C113	*87-010-263-019	CAP, ELECT 100-10V	EMI103	*87-008-372-019	FILTER EMI BL O1RNI
C114	*87-010-263-019	CAP, ELECT 100-10V	FL51	*89-VX5-616-010	FL, 9-BT-656(DISPLAY)
C115	*87-018-134-019	CAP, CERA-SOL U 0.01-16 Y	△FR2	87-029-124-019	RES, FUSE 2 2-1/4W
C116	*87-018-134-019	CAP, CERA-SOL U 0.01-16 Y	L101	*87-005-406-019	COIL CHOKE 560UH
C117	*87-018-131-019	CAP, CERA-SOL U 1000P-50 B	L102	*87-005-406-019	COIL CHOKE 560UH
C118	*87-018-131-019	CAP, CERA-SOL U 1000P-50 B	L103	*87-003-147-019	COIL CHOKE 22UH
C120	*87-018-209-019	CAP, CERA-SOL U 0.1-50 F	L201	*87-003-147-019	COIL CHOKE 22UH
C121	*87-010-248-019	CAP, ELECT 220-10V SME	L451	*87-003-147-019	COIL CHOKE 22UH
C123	*87-018-131-019	CAP, CERA-SOL U 1000P-50 B	SFR401	*87-024-173-019	SFR, 22K
C151	*87-010-374-019	CAP, ELECT 47-10V	SFR402	*87-024-173-019	SFR, 22K
C152	*87-010-374-019	CAP, ELECT 47-10V	SFR403	*87-024-168-019	SFR, 1K
C201	*87-018-134-019	CAP, CERA-SOL U 0.01-16 Y	SFR451	*87-024-173-019	SFR, 22K
C202	*87-018-134-019	CAP, CERA-SOL U 0.01-16 Y	SFR452	*87-024-173-019	SFR, 22K
C203	*87-010-374-019	CAP, ELECT 47-10V	T51	*89-VX5-627-019	TRANSFORMER FL
C204	*87-010-404-019	CAP, ELECT 4.7-50V SME	X201	*87-008-394-019	CERAMIC CST 4.19MCM
C205	*87-018-127-019	CAP, CERA-SOL U 470P-50 B	X351	*84-719-610-019	CRYSTAL 8.4672MHZ
C206	*87-018-127-019	CAP, CERA-SOL U 470P-50 B	===FRONT CIRCUIT BOARD SECTION===		
			SW501	87-036-142-019	TACT SW(S)
			SW502	87-036-142-019	TACT SW(O)
			SW503	87-036-142-019	TACT SW(+10)
			SW504	87-036-142-019	TACT SW(RANDOM)

REF. NO.	PART NO.	DESCRIPTION	REF. NO.	PART NO.	DESCRIPTION
SW505	87-036-142-019	TACT SW(4)			
SW506	87-036-142-019	TACT SW(9)			
SW507	87-036-142-019	TACT SW(DELETE)			
SW508	87-036-142-019	TACT SW(AUTO)			
SW509	87-036-142-019	TACT SW(CONT)			
SW510	87-036-142-019	TACT SW(3)			
SW511	87-036-142-019	TACT SW(8)			
SW512	87-036-142-019	TACT SW(PROGRAM/CHECK)			
SW513	87-036-142-019	TACT SW(PLAY/REPLAY)			
SW514	87-036-142-019	TACT SW(▶▶/▶▶)			
SW515	87-036-142-019	TACT SW(2)			
SW516	87-036-142-019	TACT SW(7)			
SW517	87-036-142-019	TACT SW(REPEAT/BLANK)			
SW518	87-036-142-019	TACT SW(PAUSE)			
SW519	87-036-142-019	TACT SW(◀◀/◀◀)			
SW520	87-036-142-019	TACT SW(1)			
SW521	87-036-142-019	TACT SW(6)			
SW522	87-036-142-019	TACT SW(DISPLAY)			
SW523	87-036-142-019	TACT SW(STOP/CLEAR)			
SW524	87-036-142-019	TACT SW(OPEN/CLOSE)			
===SWITCH CIRCUIT BOARD SECTION===					
SW551	87-036-087-019	SLIDE SW(TIMER)			
SW552	87-036-142-019	TACT SW(POWER)			
===MOTOR-1 CIRCUIT BOARD SECTION===					
※PCB-D	91-625-848-119	MOTOR 1 C. B(RF-310T-11400)			
※PCB-D	91-628-263-119	MOTOR 1 C. B(MDN-4RA3NTAS/4RA3ETA)			
※M1	9X-264-077-019	MOTOR GEAR ASSY(SLED) (RF-310T-11400)			
※M1	9X-264-134-419	MOTOR GEAR ASSY(SLED)(MDN-4RA3ETA)			
※M2	9X-264-133-719	MOTOR ASSY(W/CHASSIS, T. T)(SPINDLE) (RF-310T-11400)			
※M2	9X-264-134-819	MOTOR ASSY(W/CHASSIS, T. T)(SPINDLE) (MDN-4RA3NTAS)			
SW1	91-570-822-219	LEAF SW(INSIDE LIMIT)			
===MOTOR-2 CIRCUIT BOARD SECTION===					
M3	9X-264-133-610	MOTOR ASSY(LOADING)			
===MISCELLANEOUS===					
	98-848-046-519	PICK UP KSS-150A(H)(RP)			
	*89-VT5-202-010	BUSHING. CORD			
	89-VX5-618-010	FLAT CABLE 11P			
SW2	91-571-312-119	LEAF SW(OPEN/CLOSE)			

※Caution

Two Types of the spindle (DISC) motor and sled motor are used, but they are not compatible.
Check the part numbers (MDN ****, RF ****) on the labels of motors and replace motors with the same one.

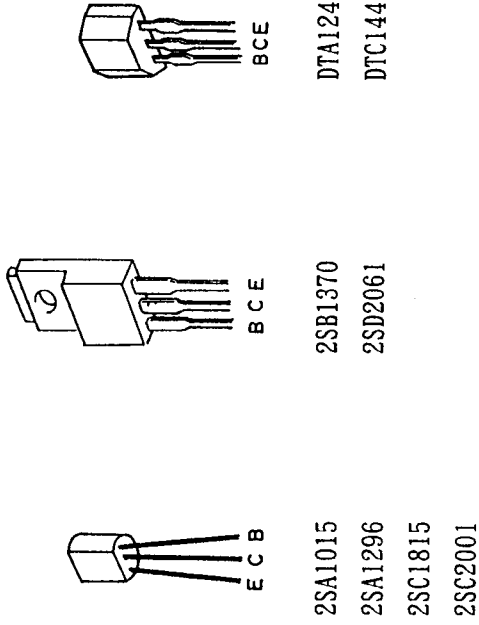



Precaution to replace Optical block (KSS - 150A)

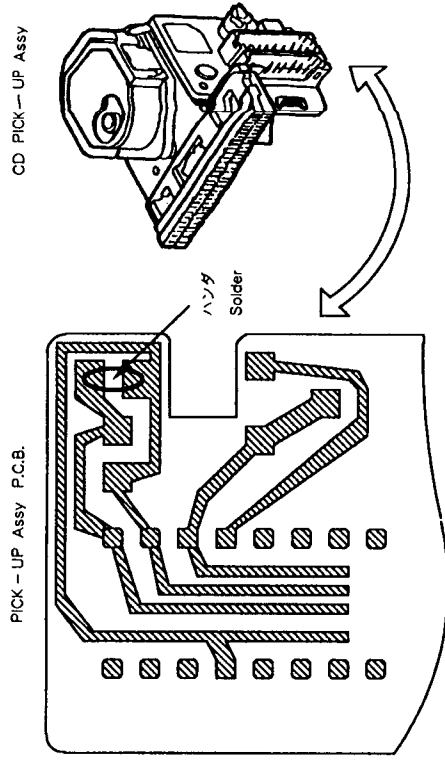

Body or clothes electrostatic potential could ruin laser diode in the optical block. Be sure ground body and workbench, and use care the clothes do not touch the diode.

- 1) After the connection, remove solder shown in figure below.

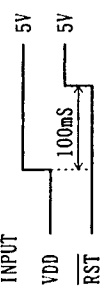
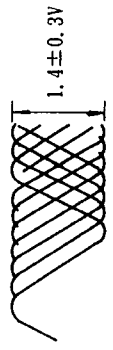

WAVE FORM VOLTAGE

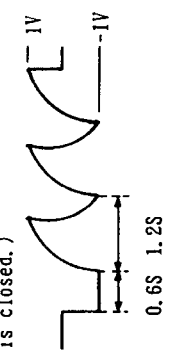
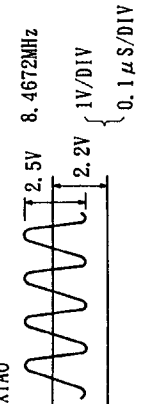
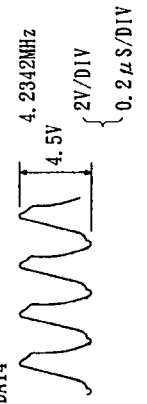
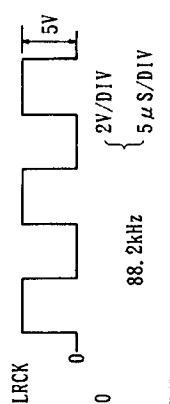
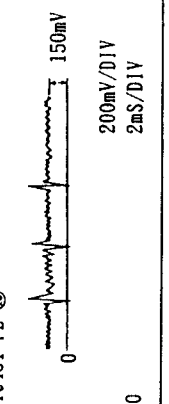
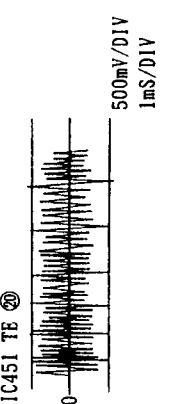
SCHMATIC DIAGRAM POINT	VOLTAGE, WAVEFORM
①	19.5V AC power supply voltage
②	3.4V AC filament voltage
③	-23.5V VFDP
④	-35.0V
⑤	12.0V +B
⑥	-12.0V -B
⑦	5.6V } Base voltage of voltage regulator transistor
⑧	
⑨	5.0V } Regulated power supply voltage
⑩	
⑪	5.0V Microcomputer power supply
⑫	RESET INPUT 
⑬	P-CONT INPUT ON 5.5V OFF(STANDBY) -0.2V
⑭	P-OFF OUTPUT ON 0V OFF 4.8V
⑮	P-OFF (DISPLAY ON/OFF) ON 4.0V OFF -32V
⑯	RF signal waveform 
⑰	VCO input Normally demultiplied output appears at CXD1135Q ⑰ pin. 
⑱	DAC I/V OUT 0dB test disc: 1.6V 1.45V(Min)~2.15V(MAX)(tolerance)

SCHMATIC DIAGRAM POINT	VOLTAGE, WAVEFORM
⑲	DE-EMPHASYS ON 3.6V OFF -5.6V
⑳	AUDIO MUTE ON 3.8V OFF -5.6V
㉑	FOCUS SEARCH (When VDD ON without DISC and tray is closed.) 
㉒	XTAO 
㉓	DA14 
㉔	LRCK 
㉕	IC451 FE ⑲ 
㉖	IC451 TE ㉑ 
㉗	TP13(F IN) ①(at FOCUS SEARCH) ≈ 1.5(V) 

BLOCK DIAGRAM

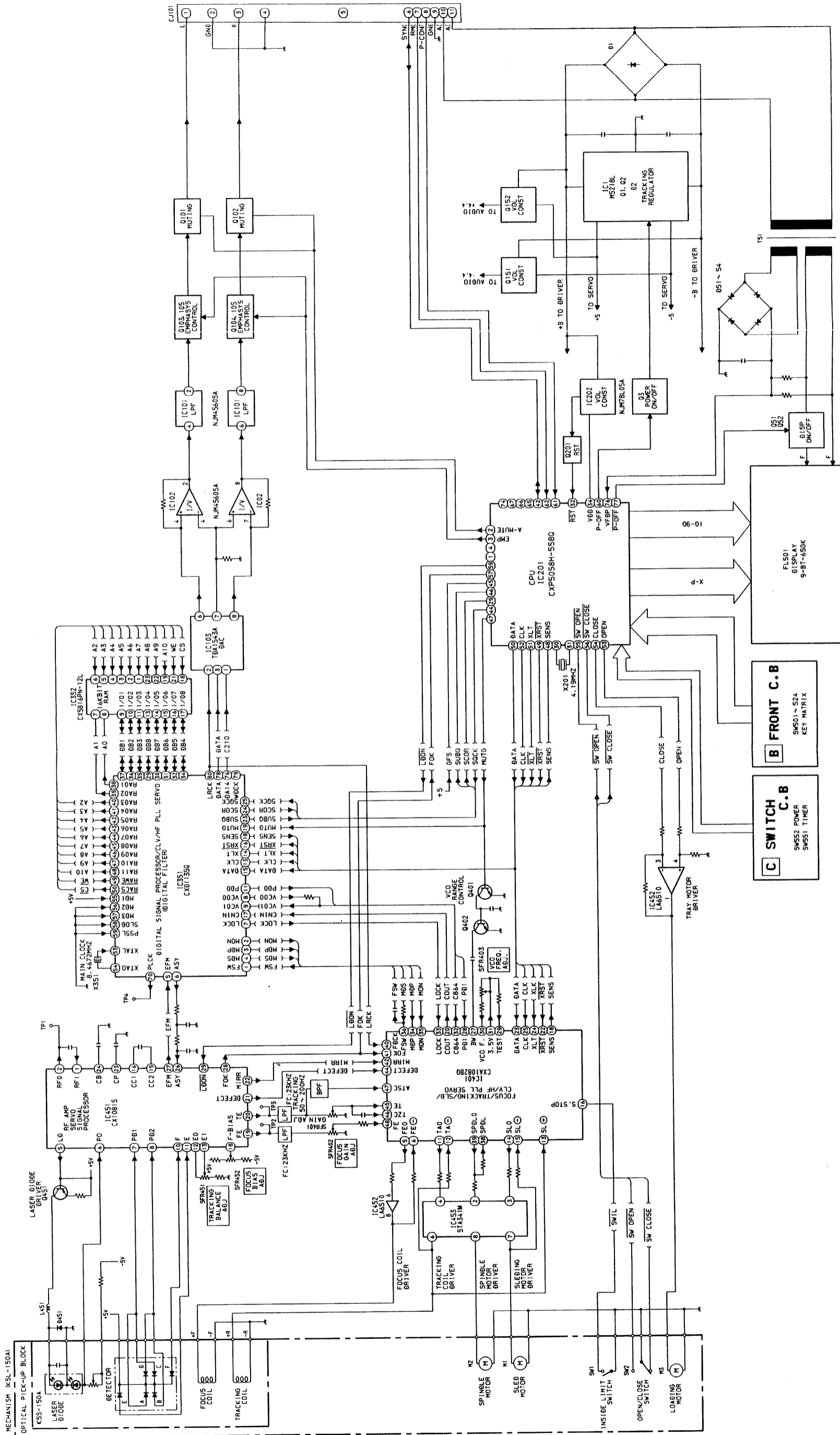

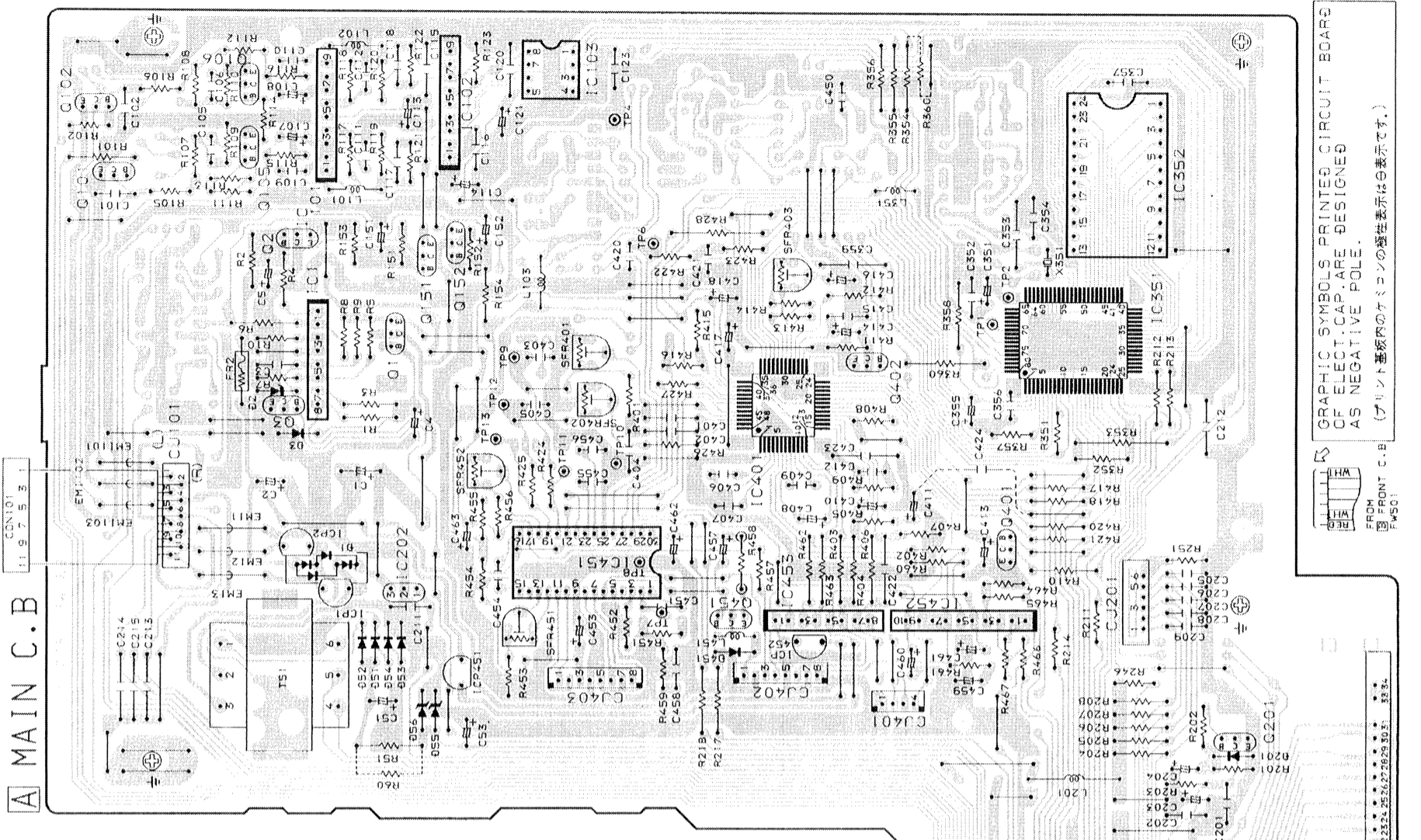
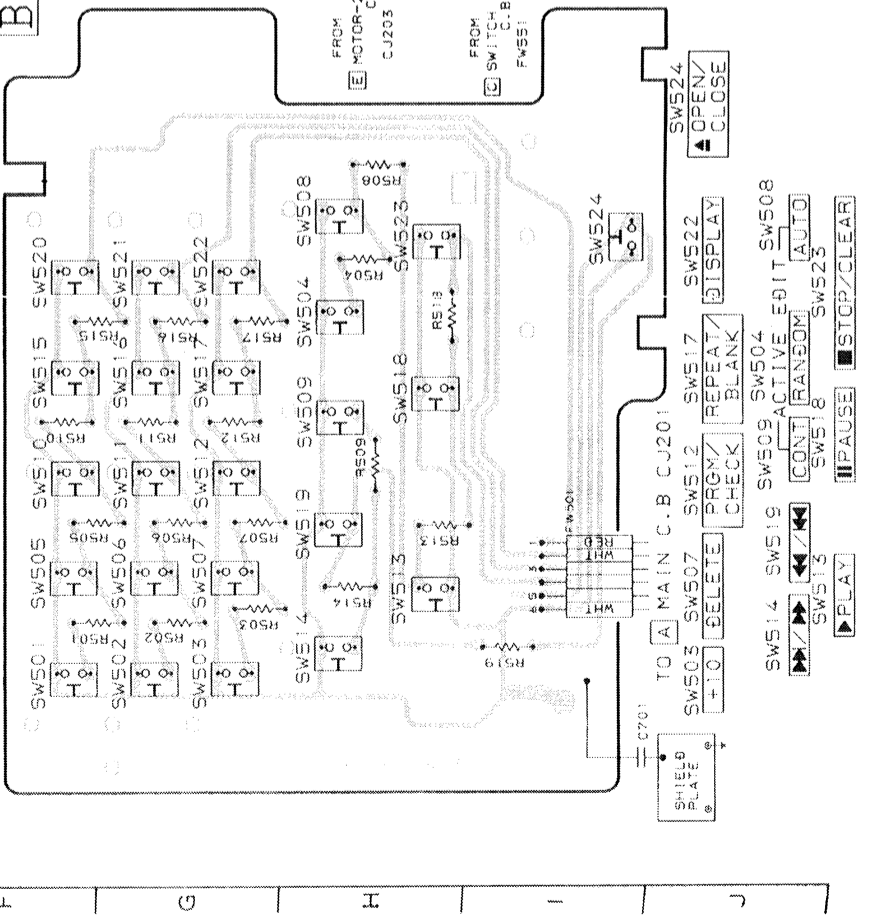
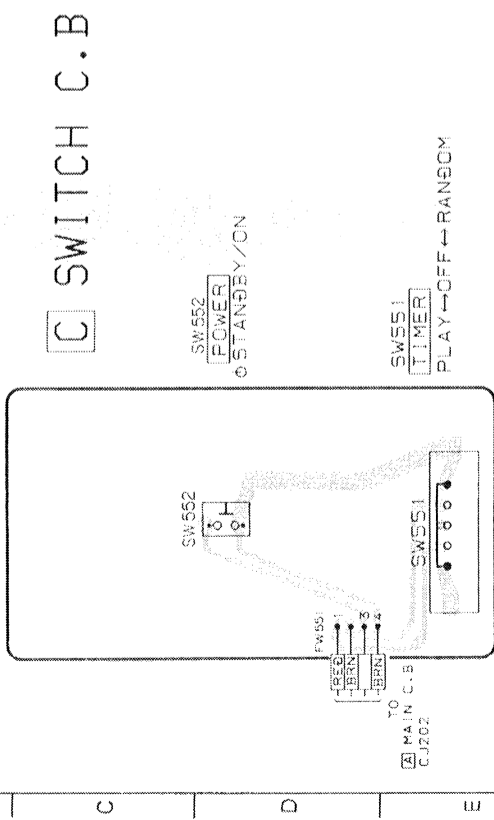
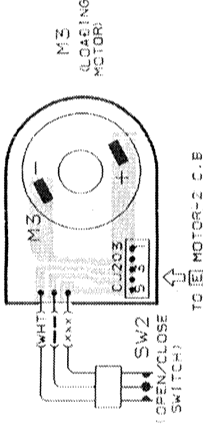
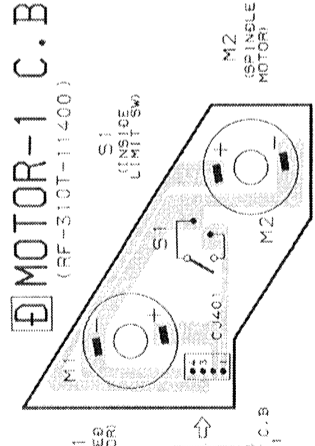
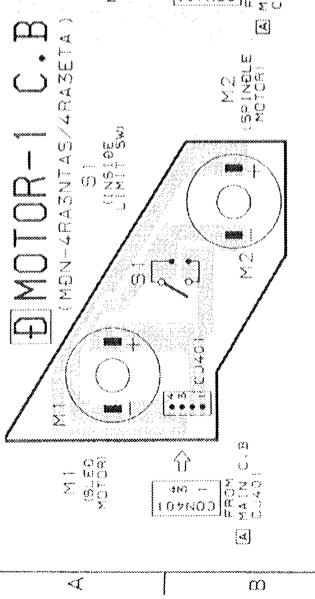

GRAPHIC SYMBOLS PRINTED CIRCUIT BOARD
OF ELECT. CAP. ARE DESIGNED
AS NEGATIVE POLE.
(プリント基板内のケミコンの極性表示は白表示です。)

SCHEMATIC DIAGRAM

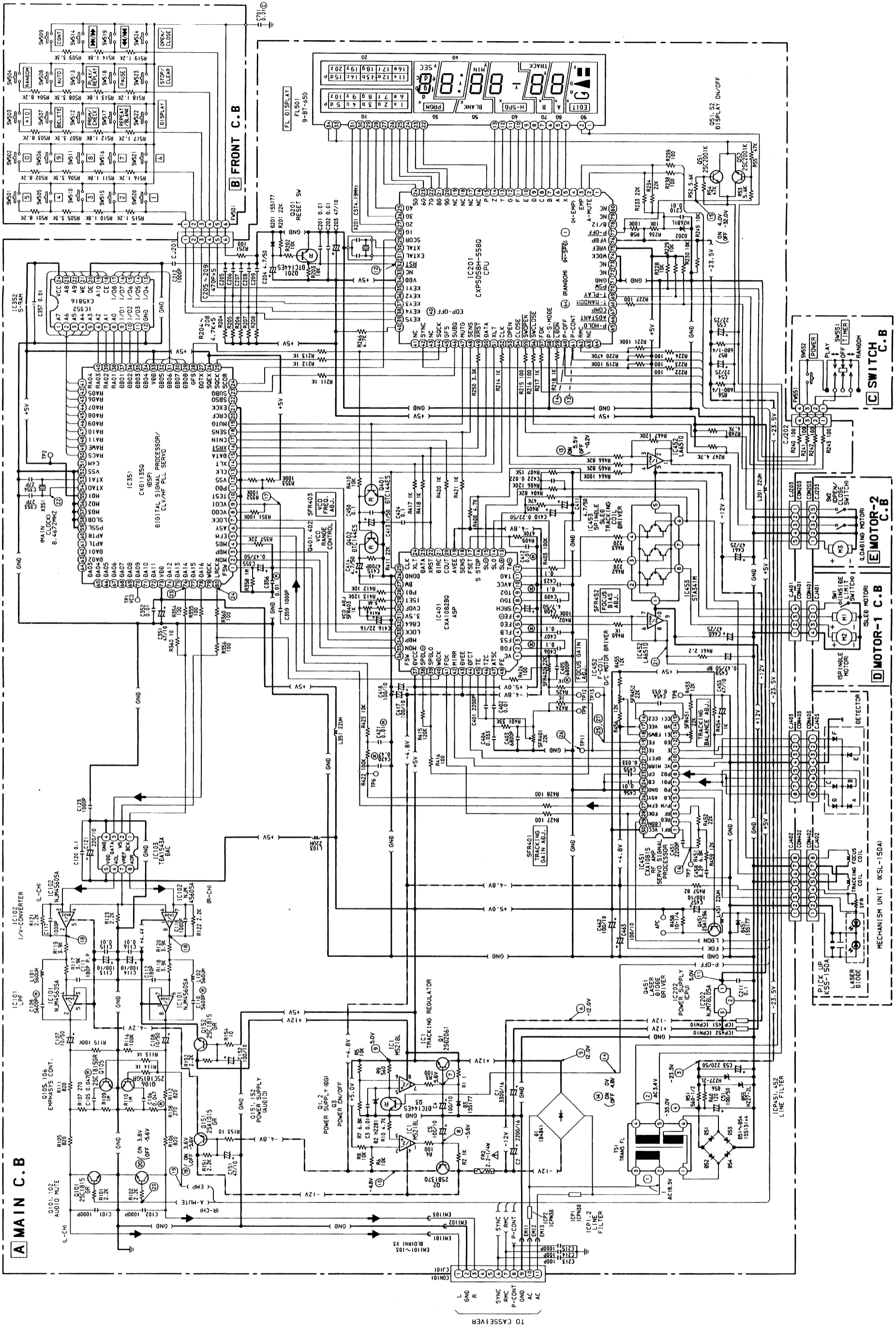

ADJUSTMENT

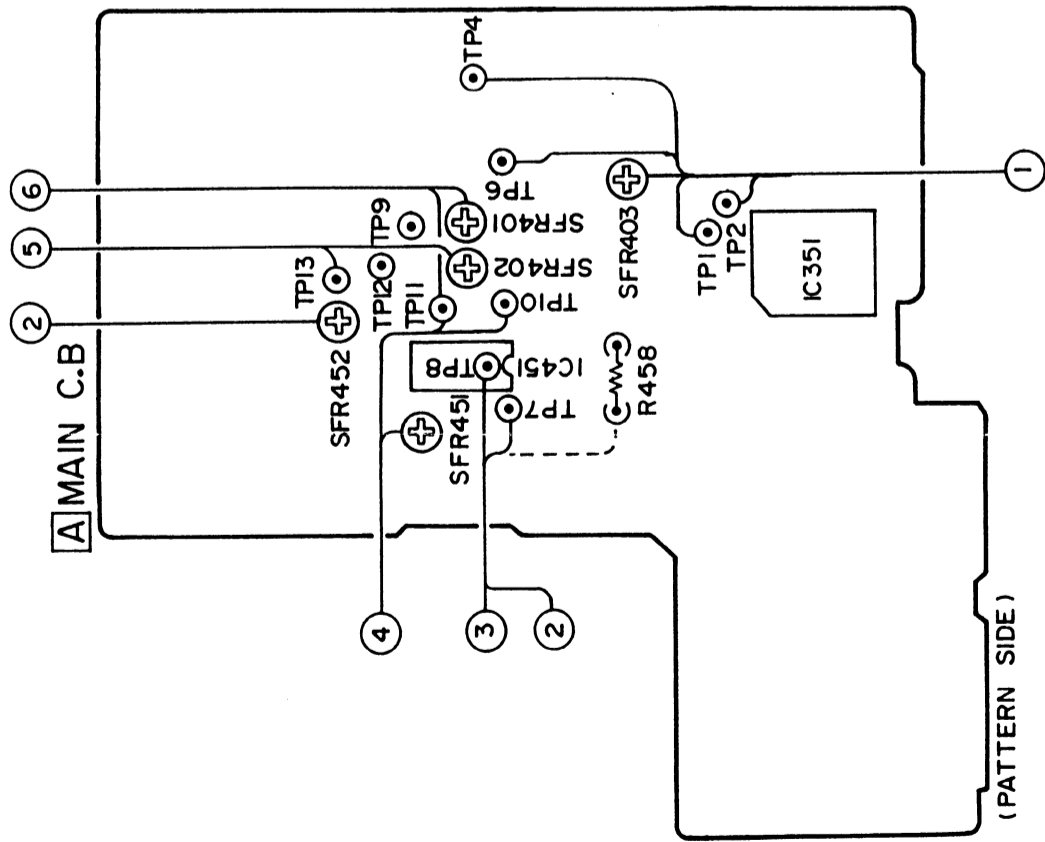

Note: Connect probe(10:1) of frequency counter and oscilloscope to test point.

① VCO Frequency Adjustment

1. Open the tray by pressing the OPEN/CLOSE button.
2. Short between test points TP6 (ASY) and TP4 (GND) using a short lead wire.
3. Connect the frequency counter to TP1 (VCO) and TP2 (GND).
4. Adjust SFR403(VCO) so that the frequency counter readings is 4.35 ± 0.05 MHz.
5. After this adjustment, remove the short lead wire from TP6 (ASY) and TP4 (GND).

② Focus Bias Adjustment

Make the focus bias adjustment when replacing and repairing the optical block.

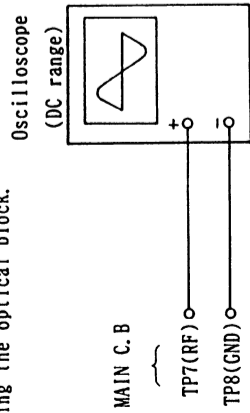

1. Connect the oscilloscope to TP7 (RF) and TP8 (GND).
2. Turn the power switch on.

③ RF Waveform Check

This check should be performed whenever the optical system block is replaced.

1. Connect the oscilloscope to TP7(RF), TP8(GND).
2. Turn on the power switch.
3. Insert the disc YEDS-18 (YEDS-1) and play back the second track.
4. Adjust SFR452(F.B) to make clear and maximize the waveform, diamond shapes (◇) can be distinguished in the center of the waveform.

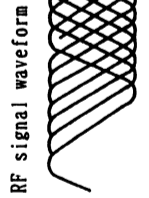

VOLT/DIV : 20mV
TIME/DIV : 0.5μsec

3. Insert the disc YEDS-18 (YEDS-1) and play back the data on the second track.
4. Adjust SPR in pickup so that the waveform on the oscilloscope is as shown in the figure below.

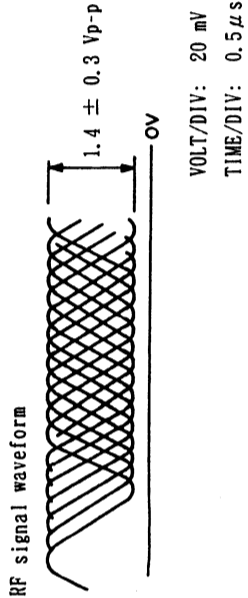

VOLT/DIV: 20 mV
TIME/DIV: 0.5μsec

Note: The current of the laser signal can be checked by checking the voltage across R458(10Ω). The specified current value is shown on the label of the pickup. The difference should be ± 6.0 mA.

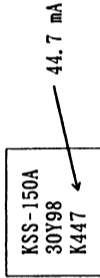

$$\text{Laser current } I_{op} = \frac{\text{Voltage across R458}}{10\Omega}$$

④ Tracking Balance Adjustment

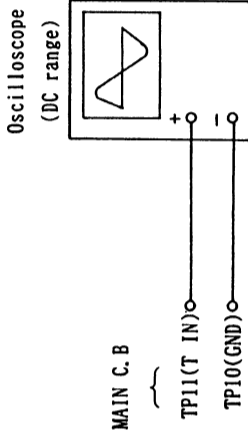

1. Connect the oscilloscope to TP11(T IN), TP10(GND).
2. Connect a center of SFR401(TE) to ground.
3. Turn on the power switch.
4. Insert disc YEDS-18 (YEDS-1) and press the ▷PLAY button.
5. Adjust SFR451(TB) so that the waveform on the oscilloscope is vertically symmetrical as shown in the figure below.

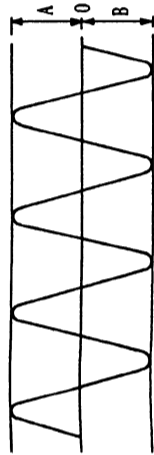

VOLT/DIV : 20mV
TIME/DIV : 2msec

6. After adjustment is completed, remove the ground lead wire.

⑤⑥ Focus/Tracking Gain Adjustment

A frequency response analyzer is necessary in order to perform this adjustment exactly.

However, this gain has a margin, so even if it is slightly off, there is no problem. Therefore, do not perform this adjustment.

Focus/tracking gain determines the pick-up follow-up (vertical and horizontal) relative mechanical noise and mechanical shock when 2-axis device operate.

However, as these reciprocate, the adjustment is at the point where both are satisfied.

- When gain is raised, the noise when the 2-axis device operates increases.
- When gain is lowered, it is more susceptible to mechanical shock and skipping occurs more easily.
- When gain adjustment is off, the symptoms below appear.

Symptoms	Gain	Focus	Tracking
● The time until music starts becomes longer for STOP → PLAY or automatic selection (◀, ▶ buttons pressed.) (Normally takes about 2 seconds.)		low	low or high
● Music does not start and disc continues to rotate for STOP → PLAY or automatic selection (◀, ▶ buttons pressed.)		—	low
● Disc table opens shortly after STOP → PLAY.	low or high	—	—
● Sound is interrupted during PLAY. Or time counter display stops progressing.	—	—	low
● More noise during 2-axis device operation.	high	high	high

The following is a simple adjustment method.

- Simple Adjustment -

Note : Since exact adjustment cannot be performed, remember the positions of the controls before performing the adjustment. If the positions after the simple adjustment are only a little different, return the controls to the original position.

Procedure :

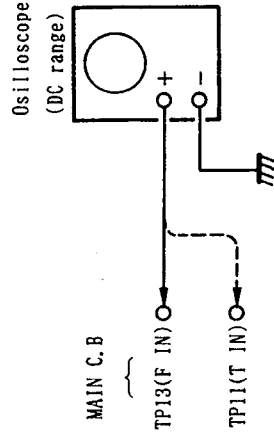

1. Keep the set horizontal.
If the set is not horizontal, this adjustment cannot be performed due to the gravity against the 2-axis device.
2. Insert a disc YEDS-18 (YEDS-1) and play back the second track.
3. Connect an oscilloscope to Main circuit board TP13(F IN)
4. Adjustment SPR402 (FE) so that the waveform is as shown in the figure below. (focus gain adjustment)

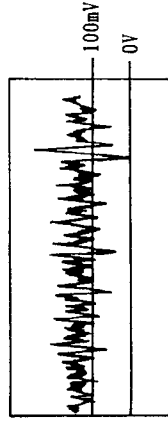

VOLT/DIV : 10mV
TIME/DIV : 2mS

- Incorrect Examples (DC level changes more than on-adjusted waveform)

low focus gain

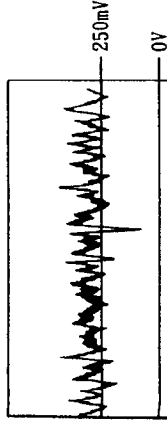

VOLT/DIV : 10mV
TIME/DIV : 2mS

high focus gain

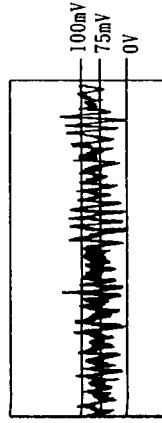

VOLT/DIV : 10mV
TIME/DIV : 2mS

5. Connect oscilloscope to Main circuit board TP11(T IN)
6. Adjust SPR401 (TE) so that the waveform is as shown in the figure below. (tracking gain adjustment)

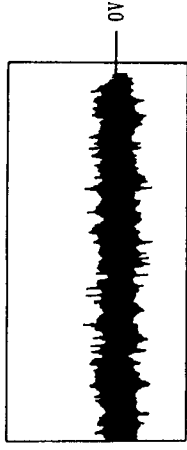

VOLT/DIV : 50mV
TIME/DIV : 2mS

- Incorrect Example (fundamental wave appears low tracking gain

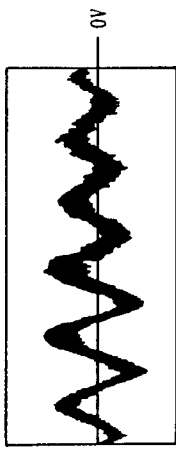

VOLT/DIV : 50mV
TIME/DIV : 2mS

- high tracking gain (higher fundamental wave than for low gain)

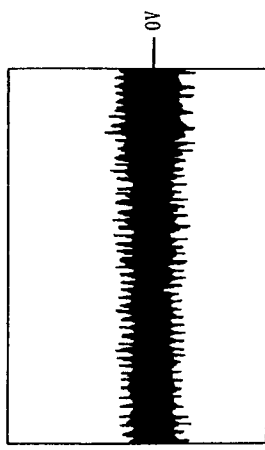

VOLT/DIV : 50mV
TIME/DIV : 2mS

PRACTICAL SERVICE FIGURE

Output level : 1.4 ± 0.2V
(TR - 2.1kHz)
Distortion : Less than 0.06 %
Frequency response : 0 ± 2dB
(20Hz,100Hz,10kHz)
I ± 2dB
(20kHz)

IC DESCRIPTION

For the description of pins as shown below, see the manual of the XC-002.		
	DX-M80	XC-002
①	IC, CXA1082BQ	IC, CXA1082S
②	IC, CXA1081S	IC, CXA1081S

IC, CXP5058H-554Q

Pin No.	Pin Name	I/O	Description
1	H-SPD		Low in high-speed mode. (Reserved)
2	A-MUTE	O	Analog mute output. High when power is on.
3	EMPH		Emphasis switching output. High when emphasis is on.
4	H-EMPH		High when emphasis is on and in high-speed mode. (Reserved)
5	x		} Display segment output.
6	a		
7	b		
8	c		
9	d		
10	e	O	
11	f		
12	g		
13	y		
14	z		
15	p		
16	NC		} Reserved.
17	NC		
18	NC		
19	NC		} Display grid scan output.
20	9G		
21	8G		
22	7G		
23	6G		
24	5G	O	
25	4G		
26	3G		
27	2G		
28	1G		
29	SCOR	I	Sub-code S0 + S1 input interrupt at the leading edge.
30	XTAL	-	} Connected to the ceramic oscillator. 4.19 MHz
31	EXTAL	I	
32	RST	I	Reset input.
33	NC	-	Reserved.
34	VDD	-	Power input terminal. Connected to +B.

Pin No.	Pin Name	I/O	Description
35	KEY1		
36	KEY2		
37	KEY3	I	KEY input.
38	KEY4		
39	KEY5		
40	EOP • OFF	—	Connected to GND.
41	NC	—	Reserved.
42	SYNC	I/O	Sync. signal to other components input or output. (8-bit serial)
43	NC	—	Reserved.
44	SQCK		Sub-code Q read and clock input.
45	GFS	I	Display signal input for frame sync. Lock status.
46	SUBQ		Sub-code Q input.
47	MUTG	O	Muting output to DSP.
48	SENS	I	Connected to DSP SENS terminal.
49	XRST	O	System reset output.
50	DATA	O	Serial data output to DSP.
51	XLT		Data latch output.
52	CLK		Data transmission clock.
53	OPEN	O	Tray open output. High when opening.
54	CLOSE		Tray close output. High when closing.
55	SW OPEN		Tray open detection switch. Low when the tray is open.
56	SW CLOSE		Tray open detection switch. Low when the tray is closed.
57	FOK	I	Indicates the status of focus. High when in focus.
58	P • S MODE		P • S 1 mode: High when peak search is performed every recording. P • S 2 mode: Low when If the disc has not been changed and the program has not been revised, only the peak point is played back.
59	LDON	O	Laser diode ON/OFF output. Low when the laser diode is on.
60	P • OFF	O	System ON/OFF output. High when power is off.
61	P • CONT	I	System ON/OFF output from other components.
62	RMC	I	42-bit serial remote control input.
63	NC	—	Reserved.
64	RANDOM		Indicates random play operation. High in random mode. (Reserved)
65	P • HOLD	O	Holds the peak of input signal from other components in the peak search mode. High when peak search mode.
66	AD START		Initial signal and AD START pulse output to the A/D conversion circuit.
67	COMP		Timing signal input for A/D conversion.
68	T • RANDOM		Random switch input. Low during random play and timer random play.
69	T • PLAY	I	Timer play mode switch input. Low in timer play mode.
70	PSW		Power switch input. ON/OFF (STAND BY) is switched.
71	GND	—	Connected to GND.
72	NC	—	Reserved.
73	NC	—	Reserved.
74	WDCK	I	Reference clock input for the peak search (AD conversion circuit)
75	VREF	—	Connected to +B.

Pin No.	Pin Name	I/O	Description
76	VFDP	-	Power input for FL tube display output. Connected to -B.
77	P-OFF	O	Low when power is off.
78	8/12	-	High when the play time of the disc is less than 23 minutes.
79	NC	-	Reserved.
80	NC	-	Reserved.

IC, CXD1135Q

Pin No.	Pin Name	I/O	Description
1	FSW	O	Output to switch the time constant of the spindle motor output filter.
2	MON	O	Spindle motor on/off control output.
3	MDP	O	Spindle motor drive output. Coarse control in the CLV. S mode and phase control in the CLV. P mode.
4	MDS	O	Spindle motor drive output. Speed control in the CLV. S mode.
5	EFM	I	Inputs an EFM signal from the RF amplifier.
6	ASY	O	Output to control the slice level of the EFM signal.
7	LOCK	O	The GFS signal is sampled by the WFCK/16. When the GFS signal is "H", this pin outputs "H", and when the signal is "L" 8 times continuously, it outputs "L".
8	VCOO	O	VCO output. When this is locked to the EFM signal. f=8.6436MHz
9	VCOI	I	VCO input
10	TEST	I	Connected to GND.
11	PDO	O	Phase comparison output between the EFM signal and VCO/2.
12	VSS	-	GND (0V)
13	CLK	I	Inputs a clock signal for the serial data transfer from CPU. Latches data at the rise of the clock signal.
14	XLT	I	Latch input from CPU.
15	DATA	I	Latches 8 bit shift register data (serial data from CPU) to each register.
16	XRST	I	Inputs serial data from CPU.
17	CNIN	I	System reset input. The system is reset at "L" input.
18	SENSE	I	Tracking pulse input.
19	MUTG	O	Outputs the internal state according to the address.
20	CRCF	O	Muting input. When the ATTM in the internal register is "L", the system is in the normal state if the MUTG is "L" and the sound is muted if the MUTG is "H".
21	EXCK	I	Outputs the CRC checking result of sub-code Q. (Reserved)
22	SBSO	O	Clock input for the sub-code serial output. Connected to GND.
23	SUBQ	O	Sub-code serial output. (Reserved)
24	SCOR	O	Sub-code Q output.
25	SQCK	O	Sub-code sync S0+S1 output.
		I/O	Clock signal for reading of sub-code Q.

Pin No.	Pin Name	I/O	Description
26	SQEX	I	SQCK select input. Connected to VDD.
27	DOTX	O	Digital audio interface output (<u>W</u> F <u>C</u> K is output when being off). (Reserved)
28	GFS	O	Output of the frame sync locking state. Goes "H" when locked.
29	DB8	I/O	Data pin of the external RAM. DATA8 (MSB)
30	DB7	I/O	Data pin of the external RAM. DATA7
31	DB6	I/O	Data pin of the external RAM. DATA6
32	DB5	I/O	Data pin of the external RAM. DATA5
33	VDD	-	Power supply (+5V).
34	DB4	I/O	Data pin of the external RAM. DATA4
35	DB3	I/O	Data pin of the external RAM. DATA3
36	DB2	I/O	Data pin of the external RAM. DATA2
37	DB1	I/O	Data pin of the external RAM. DATA1 (LSB)
38	RA1	O	Address output of the external RAM. ADDR0 (LSB)
39	RA2	O	Address output of the external RAM. ADDR1
40	RA3	O	Address output of the external RAM. ADDR2
41	RA4	O	Address output of the external RAM. ADDR3
42	RA5	O	Address output of the external RAM. ADDR4
43	RA6	O	Address output of the external RAM. ADDR5
44	RA7	O	Address output of the external RAM. ADDR6
45	RA8	O	Address output of the external RAM. ADDR7
46	RA9	O	Address output of the external RAM. ADDR8
47	RA10	O	Address output of the external RAM. ADDR9
48	RA11	O	Address output of the external RAM. ADDR10 (MSB)
49	RAWF	O	Outputs the WRITE ENABLE signal to the external RAM (active at "L").
50	RACS	O	Outputs the CHIP SELECT signal to the external RAM (active at "L").
51	C4M	O	1/2 division output of the crystal oscillator. f = 4.2336MHz (Reserved)
52	VSS	-	Connected to GND.
53	XTA1	I	Crystal oscillator input. f=8.4672MHz
54	XTA0	O	Crystal oscillator output. f=8.4672MHz
55	MD1	I	Mode select input 1 used at "H" } Used in the mode with the clock frequency 8.4672MHz, the digital output OFF, the digital filter ON
56	MD2	I	Mode select input 2 used at "L" } Connected to GND.
57	MD3	I	Mode select input 3 used at "L" } Connected to GND.
58	SLOB	I	Input to switch the code of the audio data output. "L" causes the 2 second complement output and "H" causes the offset binary output. Connected to GND.
59	PSSL	I	Input to switch the mode of the audio data output. "L" causes serial output and "H" causes parallel output. Connected to GND.

Pin No.	Pin Name	I/O	Description
60	APTR	O	Aperture correction control output. 4 4. 1 kHz with the filter OFF. (Reserved)
61	APTL	O	Aperture correction control output. 4 4. 1 kHz with the filter OFF. (Reserved)
62	DA1	O	DA1 (LSB of parallel audio data) output with PSSL = "H". C1F1 output with PSSL = "L". (Reserved)
63	DA2	O	DA2 output with PSSL = "H". C1F2 output with PSSL = "L". (Reserved)
64	DA3	O	DA3 output with PSSL = "H". C2F1 output with PSSL = "L". (Reserved)
65	DA4	O	DA4 output with PSSL = "H". C2F2 output with PSSL = "L". (Reserved)
66	DA5	O	DA5 output with PSSL = "H". C2FL output with PSSL = "L". (Reserved)
67	DA6	O	DA6 output with PSSL = "H". C2PO output with PSSL = "L". (Reserved)
68	DA7	O	DA7 output with PSSL = "H". RFCK output with PSSL = "L". (Reserved)
69	DA8	O	DA8 output with PSSL = "H". WFCK output with PSSL = "L". (Reserved)
70	DA9	O	DA9 output with PSSL = "H". PLCK output with PSSL = "L". (Note 1)(Reserved)
71	DA10	O	DA10 output with PSSL = "H". UGFS output with PSSL = "L". (Reserved)
72	DA11	O	DA11 output with PSSL = "H". GTOP output with PSSL = "L". (Reserved)
73	VDD	-	Power supply (+5V)
74	DA12	O	DA12 output with PSSL = "H". RA0V output with PSSL = "L". (Reserved)
75	DA13	O	DA13 output with PSSL = "H". C4LR output with PSSL = "L". (Reserved)
76	DA14	O	DA14 output with PSSL = "H". C210 output with PSSL = "L". (Note 2)
77	DA15	O	DA15 output with PSSL = "H". C210 output with PSSL = "L". (Reserved)
78	DA16	O	DA16 (MSB of parallel audio data) output with PSSL = "H". DATA output with PSSL = "L". (Note 3)
79	WDCK	O	Strobe signal output. 8 8. 2 kHz with the filter OFF. (Reserved)
80	LRCK	O	Strobe signal output. 4 4. 1 kHz with the filter OFF.

Note 1) $\overline{\text{PLCK}}$: VCO/2 output. When locked to the EFM signal. f=4.3218MHz

Note 2) C210: Bit clock signal. f=2.1168MHz

Note 3) DATA: Audio signal serial data output

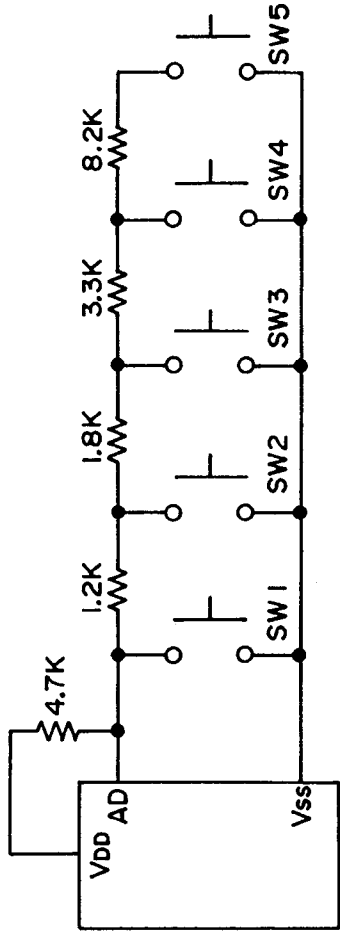

KEY MATRIX

VOLTAGE (V) PIN	0 ~ 0.33 (SW1)	0.82 ~ 1.29 (SW2)	1.78 ~ 2.21 (SW3)	2.69 ~ 3.06 (SW4)	3.56 ~ 4.06 (SW5)
FW501①	1	2	3	4	5
FW501②	6	7	8	9	0
FW501③	DISPLAY	REPEAT /BLANK	PROGRAM /CHECK	DELETE	+ 1 0
FW501④	STOP /CLEAR	PAUSE	PLAY /REPLAY	AUTO	RANDOM
FW501⑤	OPEN /CLOSE	F•BWD /B•SKIP	F•FWD /F•SKIP	CONT.	—

KEY SWITCH INPUT VOLTAGE

ANALOG INPUT VOLTAGE	CONDITION	DIGITAL VALUE
0.0 ~ 0.33V	VDD 5V	000
0.82 ~ 1.29V		001
1.78 ~ 2.21V		010
2.69 ~ 3.06V		011
3.56 ~ 4.06V		100
4.62 ~ 5.0V		101

EXPLODED VIEW - 1

REF. NO.	PART NO.	DESCRIPTION
A	87-743-095-41	UT,+3-8 (W/O SLOT) (B)
B	87-067-688-01	BVTT+3-6
C	87-067-685-01	BVIT,+2,6-8
D	87-067-716-01	BVTT+3-6 (B)
E	87-067-680-01	BVIT,B+3-10
F	87-571-095-41	VIT+3-8
G	87-067-673-01	BVTT+3-8 (B)

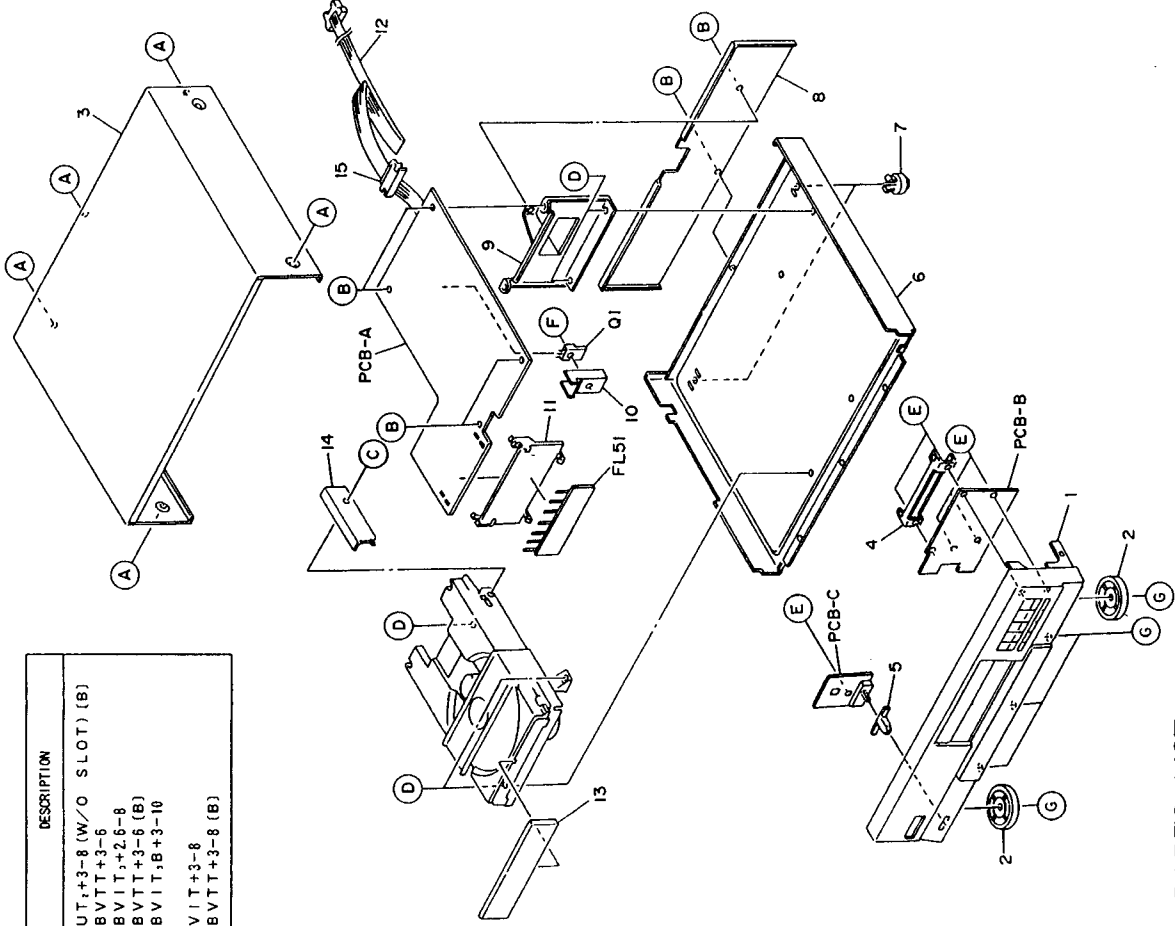

MECHANICAL PARTS LIST

PART NO. CHANGED TO	REF. NO.	PART NO.	DESCRIPTION	COMMON MODEL	Q'TY
	1-1	★09-057-064-010	FRONT CABINET ASSY	※	1
	1-2	★87-085-215-010	FOOT, H12 DIA58	※	2
	1-3	★89-MD1-019-018	CABINET, STEEL (YN, YJ)	※	1
	1-3	★89-VX5-003-019	CABINET, STEEL (YK, YNE)	※	1
	1-4	★89-MD1-201-019	HOLDER, P.C.B (YN, YJ)	※	1
	1-4	★89-MD1-203-018	HOLDER, P.C.B (YK, YNE)	※	1
	1-5	★81-715-029-019	KNOB, SLIDE	※	1
	1-6	----	CHASSIS, MAIN	※	1
	1-7	★87-085-214-010	FOOT, H16	※	2
	1-8	★89-MD1-011-019	PANEL, REAR (YN)	※	1
	1-8	★89-MD1-012-019	PANEL, REAR (YJ)	※	1
	1-8	★89-MD1-014-010	PANEL, REAR (YK, YNE)	※	1
	1-9	★89-VX5-204-019	HOLDER, CENTER (YN, YJ)	※	1
	1-9	★89-MD1-204-018	HOLDER, CENTER (YK, YNE)	※	1
	1-10	----	HEAT SINK CT	※	1
	1-11	★89-VX5-202-010	GUIDE, FL	※	1
	1-12	----	FLAT CABLE 11P FG	※	1
	1-13	★89-MD1-002-019	PANEL, TRAY	※	1
	1-14	★89-VX5-205-019	HOLDER, MECHANISM (YN, YJ)	※	1
	1-14	★89-MD1-205-018	HOLDER, MECHANISM (YK, YNE)	※	1
	1-15	★89-VT5-202-010	BUSHING, CORD	※	1

EXPLODED VIEW - 2

REF. NO.	PART NO.	DESCRIPTION
A	97-685-862-01	BVTT+2.6-6
B	92-642-142-01	SCREW
C	97-685-132-19	B+2.6-5
D	97-685-135-19	B+2.6-10
E	97-685-851-01	BVTT+2-4
F	93-558-708-21	STOPPER WASHER
G	94-812-554-00	WASHER
H	97-621-775-00	B+2.6-3
I	97-621-255-25	PTT+2-4
J	97-685-647-79	B+3-10
K	92-642-172-01	SPACER
L	97-685-143-19	PTPWH+2-8

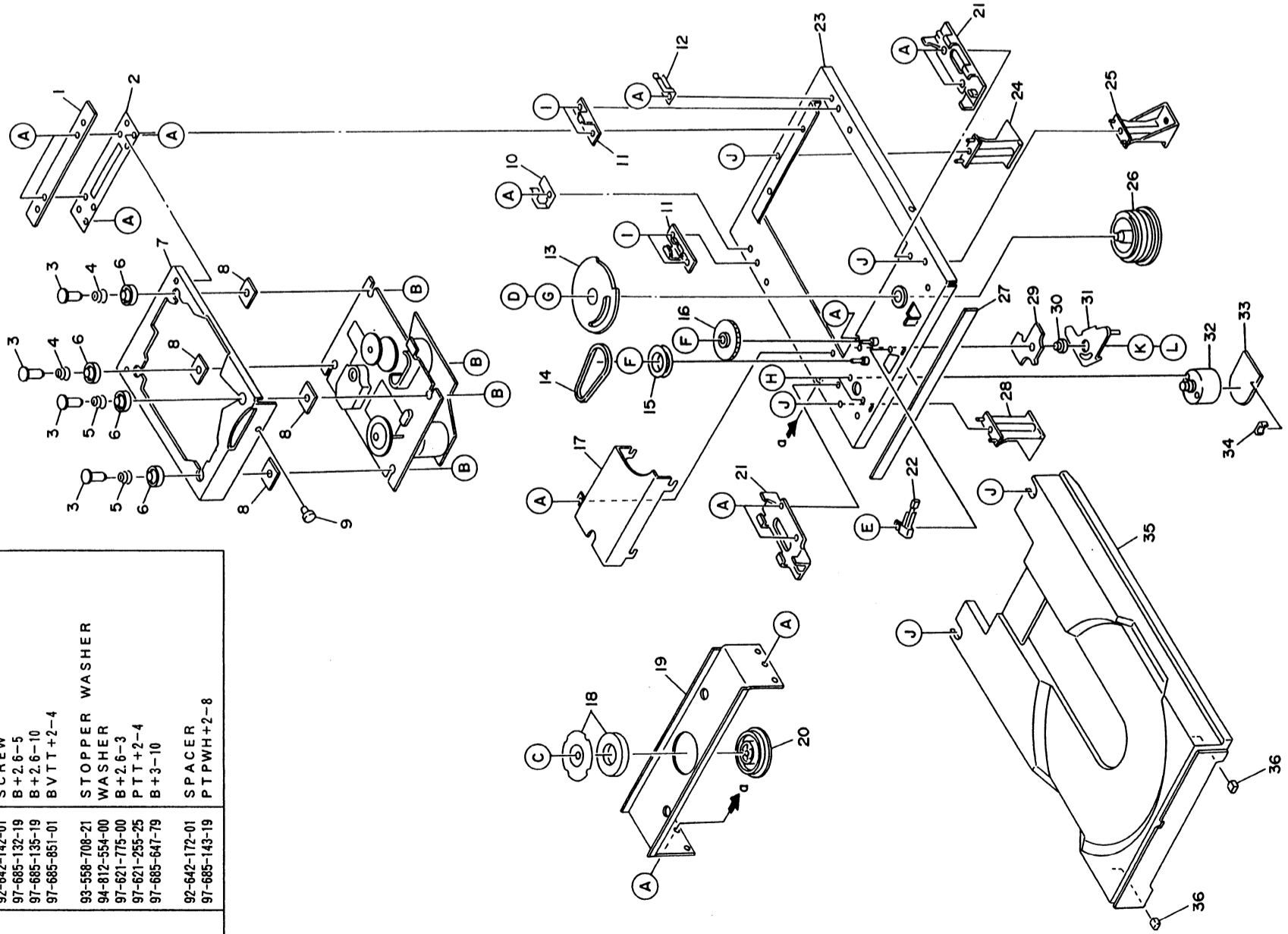

PART NO.
CHANGED TO

COMMON
MODEL

REF. NO.	PART NO.	DESCRIPTION	Q'TY
2-1	★92-642-170-010	HOLDER, HING	1
2-2	★92-642-164-010	SPRING, HING	1
2-3	★92-642-160-010	SHAFT, SPRING T	4
2-4	★92-642-137-010	SPRING, COIL B	2
2-5	★92-642-139-010	SPRING, COIL A	2
2-6	★92-642-158-010	FOOT C	4
2-7	★9X-264-210-510	SPRING SUB CHASSIS ASSY	1
2-8	★92-642-159-010	PLATE, SPRING T	4
2-9	★92-642-169-010	ROLLER	1
2-10	★92-642-147-010	GUIDE, TRAY L	1
2-11	★92-642-162-020	HOLDER, TRAY	2
2-12	★92-642-146-010	GUIDE, TRAY R	1
2-13	★92-642-154-020	GEAR, SPRING DRIVE	1
2-14	93-653-387-000	LM BELT	1
2-15	★94-913-731-010	PULLEY, ROADING	1
2-16	★92-642-148-010	GEAR, SPRING RELAY	1
2-17	★92-642-149-010	COVER, SPRING GEAR	1
2-18	91-452-507-110	MAGNET ASSY	1
2-19	★92-642-165-010	CHUCK CHASSIS	1
2-20	★92-642-432-010	CHUCKING PULLEY	1
2-21	★92-642-161-010	HOLDER, FRONT TRAY	2
2-22	91-571-312-110	LEAF SWITCH (OPEN/CLOSE)	1
2-23	★9X-264-210-610	SPRING MAIN CHASSIS ASSY	1
2-24	★92-642-512-010	MD HOLDER BOSS REAR	1
2-25	★92-642-510-010	MD HOLDER BOSS	1
2-26	★92-642-153-010	CAM, SPRING CONTROL	1
2-27	★92-642-157-030	TAPE, FRONT	1
2-28	★92-642-511-010	MD HOLDER BOSS L	1
2-29	★92-642-173-010	PLATE, RING	1
2-30	★92-642-133-020	BOSS	1
2-31	★9X-264-210-710	STOPPER RING ASSY	1
2-32	9X-264-133-610	MOTOR ASSY (LOADING)	1
2-33	★91-624-793-210	CD MOTOR 2 C.B	1
2-34	★91-564-721-110	CONNECTOR PIN 5 P	1
2-35	★92-642-156-010	TRAY	1
2-36	★92-642-125-010	DAMPER	2

EXPLODED VIEW - 3

REF. NO.	PART NO.	DESCRIPTION
A	92-642-144-01	PTT+2-6
B	97-621-255-35	P+2-5
C	93-303-809-31	SPECIAL SCREW M1.7-3
D	92-641-447-01	STP+2.6-8

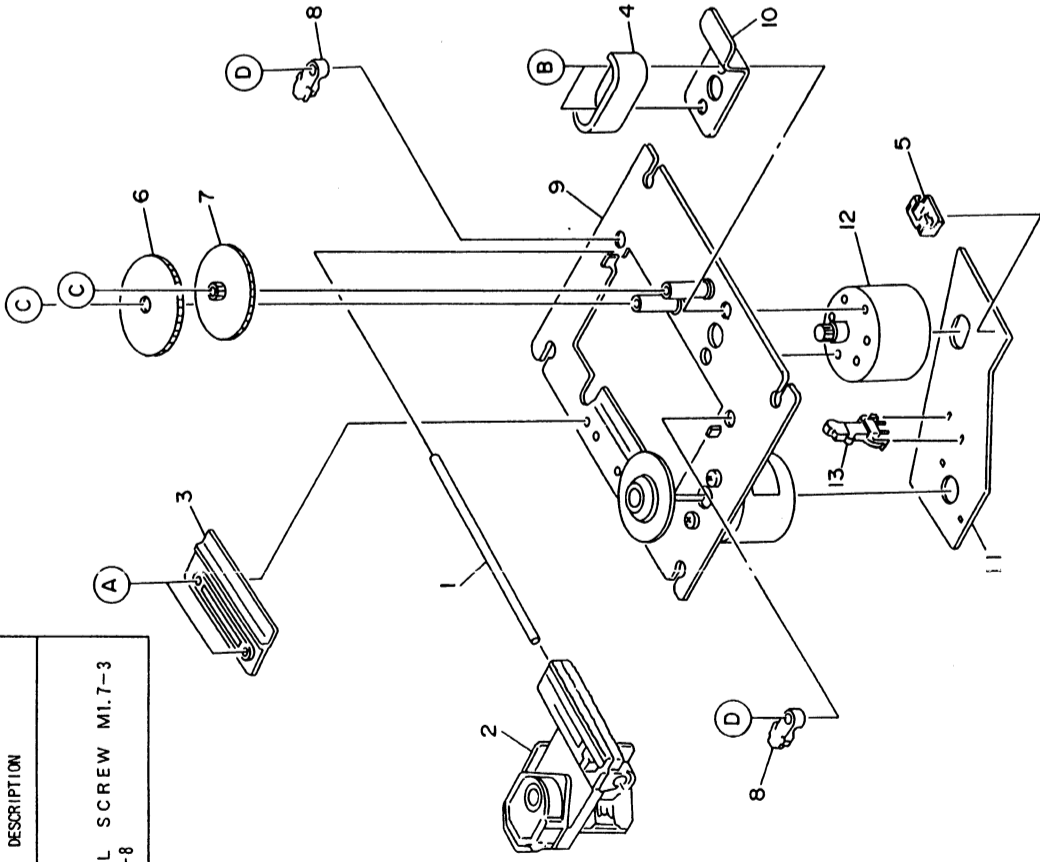

PART NO. CHANGED TO	REF. NO.	PART NO.	DESCRIPTION	COMMON MODEL	Q'TY
	3-1	★94-910-431-010	SHAFT, SLIDE		1
	3-2	98-848-046-510	PICK UP (KSS-150AHRP)		1
	3-3	★92-641-443-010	HOLDER, SLIDE		1
	3-4	★92-641-434-010	COVER, GEAR		1
	3-5	★92-564-720-110	CONNECTOR PIN		1
	3-6	9X-264-076-910	GEAR A		1
	3-7	★92-641-403-050	GEAR B		1
	3-8	★92-641-448-020	CLUMP, SHAFT		2
	※ 3-9	9X-264-133-710	SP MOTOR ASSY (W/CHASSIS, I.T) (DISC) (RF-310T-11400)		1
	※ 3-9	9X-264-134-810	SP MOTOR ASSY (W/CHASSIS, I.T) (DISC) (MDN-4RA3NTAS)		1
	3-10	★92-641-371-010	STOPPER		1
	※ 3-11	★91-625-848-110	CD MOTOR 1 C.B (RF-310T-11400)		1
	※ 3-11	★91-628-263-110	CD MOTOR 1 C.B (MDN-4RA3NTAS/4RA3ETA)		1
	※ 3-12	9X-264-077-010	SLED MOTOR GEAR ASSY (SLED) (RF-310T-11400)		1
	※ 3-12	9X-264-134-410	SLED MOTOR GEAR ASSY (SLED) (MDN-4RA3ETA)		1
	3-13	91-570-822-210	LEAF SWITCH (LIMIT)		1

※Caution

Two types of the spindle (DISC) motor and sled motor are used, but they are not compatible.
Check the part numbers (MDN ..., RF ...) on the labels of motors and replace motors with the same one.