

AKAI SERVICE MANUAL

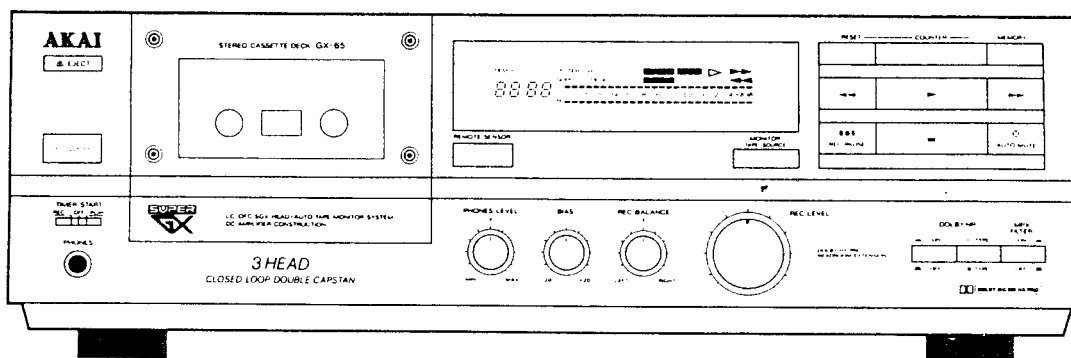

STEREO CASSETTE DECK

MODEL GX-65

SPECIFICATIONS

Track system	4 track 2 channel stereo	Total harmonic distortion .	0.7%
Heads		Input(Level/Impedance)	
Erase head	×1	Line	70mV/47kohms
Recording head	LC-OFC SGX ×1	Output	
Playback head	LC-OFC SGX ×1	(Level/Impedance)	
Motors		Line	388mV/2kohms
Capstan drive	Electronically controlled DC motor ×1	Headphone	1.3mW/8ohms
Reel drive	DC motor ×1	Power requirement	AC 220V, 50Hz for Europe except UK
Wow and flutter	0.06%(DIN), 0.035(WRMS)		AC 240V, 50Hz for UK and Australia
Tape winding time	80 sec.(C-60 Tape)		AC 110V-120V/220V-240V, 50Hz/60Hz convertible for other countries
Frequency response		Dimensions	425(W)×137(H)×353(D) mm (16.7×5.4×13.9 inches)
Normal tape	15Hz to 19,000Hz ±3dB	Weight	5.5kg(12.1 lbs)
CrO2 tape	15Hz to 19,000Hz ±3dB		
Metal tape	15Hz to 21,000Hz ±3dB		
S/N	57dB(Metal tape)		
	Dolby B type NR switch ON: Improves up to 5dB at 1kHz, 10dB above 5kHz		
	Dolby C type NR switch ON: Improves up to 15dB at 500Hz, 20dB at 1kHz to 10kHz	Standard accessories	
		Connection cord	×2
		Operator's manual	×1

- * For improvement purposes, specifications and design are subject to change without notice.
- * Noise reduction manufactured under license from dolby laboratories licensing corporation. "DOLBY" and  symbol are trade marks of dolby licensing corporation.

★ SAFETY INSTRUCTIONS

PRECAUTIONS DURING SERVICING

- Parts identified by the Δ (*) symbol are critical for safety. Replace only with parts number specified.
- In addition to safety, other parts and assemblies are specified for conformance with such regulations as those applying to spurious radiation. These must also be replaced only with specified replacements.
Examples: RF converters, tuner units, antenna selector switches, RF cables, noise blocking capacitors, noise blocking filters, etc.
- Use specified internal wiring. Note especially:
 - Wires covered with PVC tubing
 - Double insulated wires
 - High voltage leads
- Use specified insulating materials for hazardous live parts. Note especially:
 - Insulation Tape
 - PVC tubing
 - Spacers (Insulating Barriers)
 - Insulation sheets for transistors
 - Plastic screws for fixing microswitch (especially in turntable)
- When replacing AC primary side components (transformers, power cords, noise blocking capacitors, etc.), wrap ends of wires securely about the terminals before soldering.

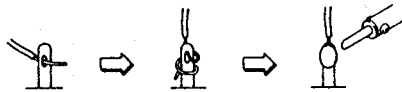

- Observe that wires do not contact heat producing parts (heatsinks, oxide metal film resistors, fusible resistors, etc.).

★ INFORMATION

SYMBOLS FOR PRIMARY DESTINATION

Alphabet indicates the destination of the units as listed below.

Symbols	Principal Destinations
A	USA
B	UK
C	Canada
E	Europe (except UK)
J	Japan
S	Australia
V	W. Germany only
U	Universal Area
Y*	Custom version

- Check that replaced wires do not contact sharp edged or pointed parts.
- Also check areas surrounding repaired locations.
- Use care that foreign objects (screws, solder droplets, etc.) do not remain inside the set.

SAFETY CHECK AFTER SERVICING

After servicing, make measurements of leakage-current or resistance in order to determine that exposed parts are acceptably insulated from the supply circuit.

The leakage-current measurement should be done between accessible metal parts (such as chassis, ground terminal, microphone jacks, signal-input/output connectors, etc.) and the earth ground through a resistor of 1500 ohms paralleled with a 0.15 μ F capacitor, under the unit's normal working conditions. The leakage-current should be less than 0.5 mA rms AC.

The resistance measurement should be done between accessible exposed metal parts and power cord plug prongs with the power switch (if included) "ON". The resistance should be more than 2.2 Mohms.

VOLTAGE CONVERSION (U Model only)

Before connecting the power cord. Set the VOLTAGE SELECTOR located on the rear panel with a screwdriver so that the correct voltage is indicated.

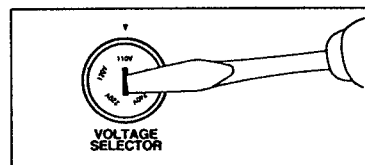

I. CONTROLS

I-1. FRONT PANEL

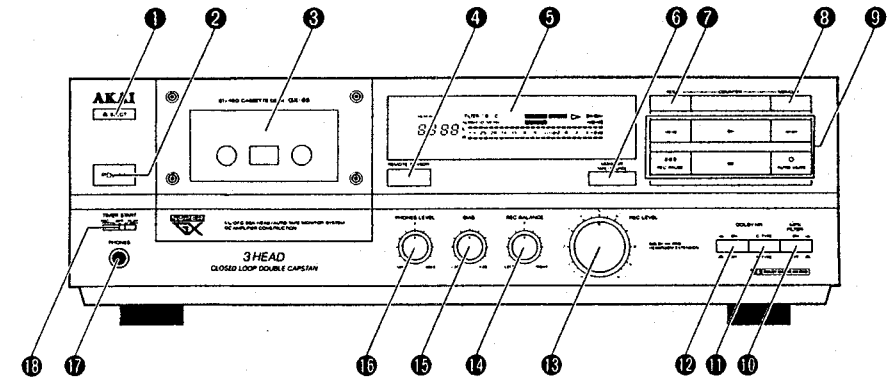

Fig. 1-1

- EJECT button**
To open the cassette holder and eject the cassette tape.
- POWER button**
To turn the power on and off.
- Cassette Lid and Holder**
Load a cassette tape here.
- REMOTE SENSOR Window**
For reception of the remote control signal from the optional RC-G95 remote control unit. Keep away from strong light and direct sunlight as this will interfere with the remote control function.
Note for the RC-G95 remote control unit
The DISPLAY, IPSS, MEMORY A -- B and REC CANCEL buttons no function on the GX-65 remote control.
- FL Display**
Tells you what the cassette deck is doing.
- MONITOR Button (TAPE/SOURCE)**
To select between TAPE and SOURCE monitor modes. This button is incorporated with an auto monitor system.
- COUNTER RESET Button**
To reset the digital tape counter to the "0000" position.
- COUNTER MEMORY Button**
To turn the counter memory system on and off.
- Operation Buttons** (◀◀: Rewind button, ▶▶: Play button, ▶▶▶: Fast forward button, ⏸: REC PAUSE button, ■: Stop button, ○: AUTO MUTE button)
To start and stop recording and playback, to wind the tape and to engage the auto mute mode.
- MPX FILTER Switch** (ON/OFF)
To turn the multiplex filter on and off.
- DOLBY NR C-TYPE/B-TYPE Select Switch** (C-TYPE/B-TYPE)
To select between B type or C type noise reduction for recording and playback purposes.
- DOLBY NR ON/OFF switch** (ON/OFF)
To turn the DOLBY NR system on and off for recording and playback purposes.
- REC LEVEL Control**
To set the recording input level. The level adjustment is the same amount for both left and right channels.
- REC BALANCE Control (LEFT/RIGHT)**
To set the recording input level left and right channel balance. Normally set the control to the center click "1" position.
- BIAS Control (-20/+20)**
To adjust the recording bias current during recording. The bias adjustment range is between -20% and +20% of the proper bias current for Normal, CrO₂ and Metal position tapes. Normally set the control to the center click "0" position.
- PHONES LEVEL Control (MIN/MAX)**
To adjust the output level of the PHONES jack.
- PHONES Jack**
For headphone connection.
- TIMER START Switch (REC/OFF/PLAY)**
To select operation of the timer start function when the power is turned on.

1-2. FL (FLuorescent) display

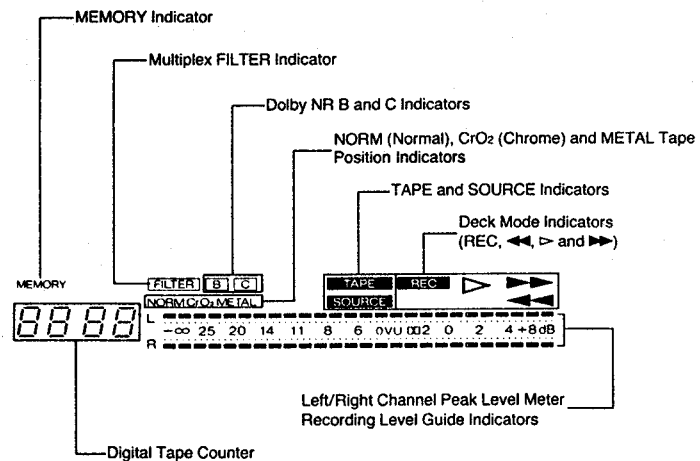

Fig. 1-2

II. DISASSEMBLY

Incase of trouble, etc., necessitating dismantling in the order shown in the illustrations. Reassemble in reverse order.

<p>1. Removal of UPPER COVER</p>	<p>3.</p> <p>Remove CASSETTE LID first, then remove FRONT PANEL next</p>
<p>2. Removal of FRONT PANEL BLK</p>	<p>4. Removal of MECHA. BLK</p> <p>1) Remove LID DECORATION while releasing two LID DECORATION HOOKS. 2) Disconnect all the wire connectors from MECHA BLK. 3) Slide the MECHA BLK to bottom a little and extract the MECHA BLK to rear side.</p>

III. PRINCIPAL PARTS LOCATION

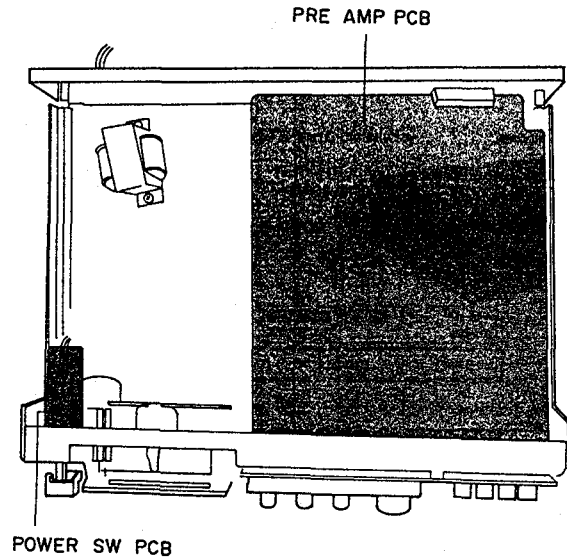

Fig. 3-1

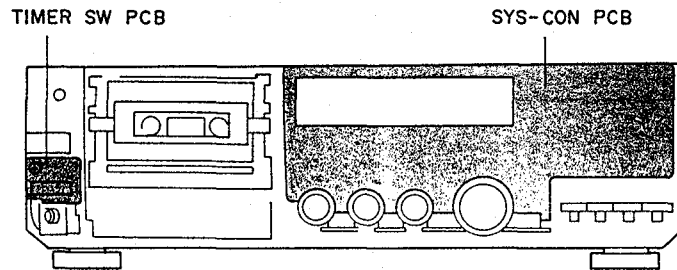
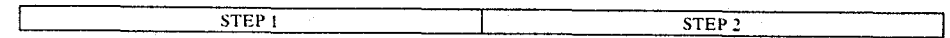

Fig. 3-2

IV. PRINCIPAL PARTS REPLACEMENT OF MECHA BLK

4-1. DISASSEMBLY/ASSEMBLY PROCEDURE OF PRINCIPAL PARTS

* Refer to "II. DISASSEMBLY" for removal of MECHA. BLK.



- HEAD BLOCK
 - PINCH ROLLER BLOCK
 - SEPARATION OF MECH. BLOCK
- DRIVE BELT
 - SOLENOID
 - REEL MOTOR

4-2. REPLACEMENT OF PINCH ROLLER BLK

4-2-1. TAKE UP PINCH ROLLER BLK

- 1) Extract TAKE UP PINCH ROLLER BLK to upper direction while releasing the HOOK of TAKE UP PINCH ROLLER BLK.
- 2) Just push in the TAKE UP PINCH ROLLER BLK when reassemble TAKE UP PINCH ROLLER BLK.

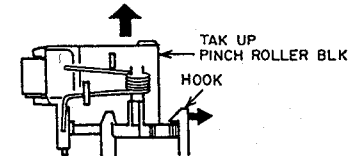

Fig. 4-1

4-2-2. SUPPLY PINCH ROLLER BLK

- 1) Remove the TAPE GUIDE (A) HEIGHT ADJUSTMENT @ SCREW (Refer to Fig. 5-6), then remove the SUPPLY PINCH ROLLER BLK.

[NOTE]
After reassemble SUPPLY PINCH ROLLER BLK, 5-4. TAPE GUIDE HEIGHT ADJUSTMENT is necessary to adjust.

4-3. REPLACEMENT OF REC/PB HEAD

- 1) Remove HEAD FIXATION SCREWS.
- 2) Disconnect the lead wires by soldering iron.
- 3) When reassembling the REC/PB head, connect the lead wires referring Fig. 4-3 by soldering iron. then secure HEAD FIXATION SCREWS.

[NOTE]
Before disconnect the lead wires, confirm that the color of lead wires are same as Fig. 4-3.

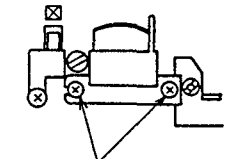

Fig. 4-2

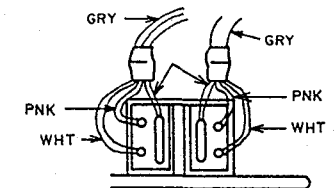

Fig. 4-3

4-4. UPPER AND LOWER SEPARATION OF MECHA. BLK

- 1) Remove two ④ screws and separate UPPER and LOWER PARTS of MECHA. BLK.

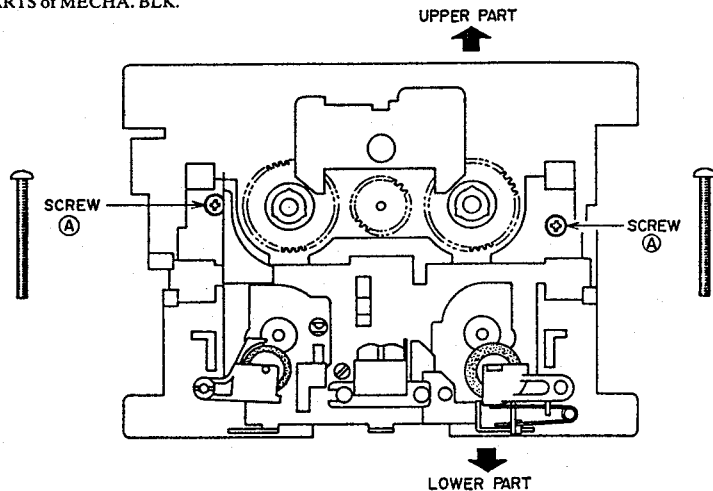

Fig. 4-4

4-5. REPLACEMENT OF CAPSTAN MOTOR

- 1) Separate UPPER and LOWER of MECHA. BLK (Refer to 4-4. UPPER AND LOWER SEPARATION OF MECHA. BLK)
- 2) Disconnect the lead wires by soldering iron.
- 3) Remove MOTOR FIXATION ③ SCREW.
- 4) Reassemble in reverse order and set the drive belt on to motor pulley.

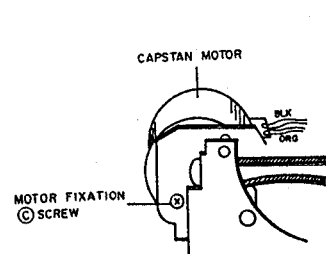

Fig. 4-5

4-6. REPLACEMENT OF DRIVE BELT

- 1) Remove two BRACKET fixation ⑤ SCREWS and remove the BRACKET, then replace the drive belt.
- 2) Reassemble in reverse order.

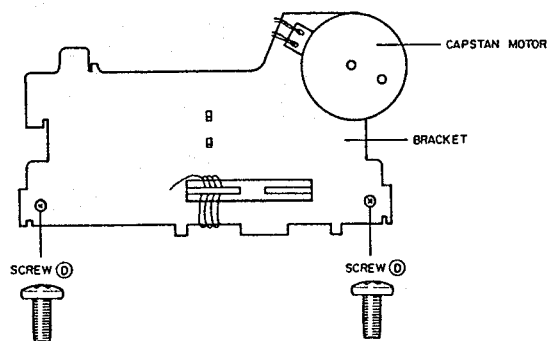

Fig. 4-6

4-7. REPLACEMENT OF REEL MOTOR

- 1) Remove SOLDER of each detection switches, lead wires from solenoid and REEL MOTOR leads by soldering iron.
- 2) Remove REEL PULSE DETECTION PCB while releasing the PCB FIXATION HOOKS of REEL PULSE DETECTION PCB on the front side of MECHA. BLK.
- 3) Remove two REEL MOTOR FIXATION ⑥ SCREWS and remove REEL MOTOR.
- 4) Reassemble in reverse order.

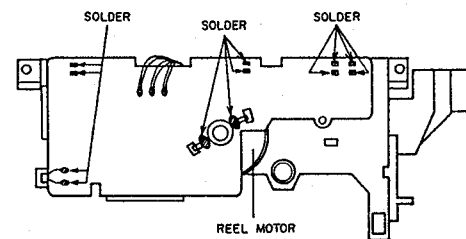

Fig. 4-7

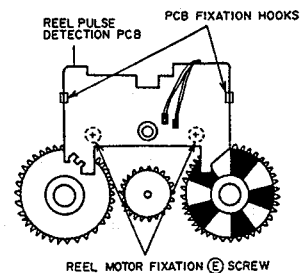

Fig. 4-8

4-8. REPLACEMENT OF SOLENOID

- 1) Separate UPPER and LOWER PART of MECHA. BLK (Refer to 4-4. UPPER AND LOWER SEPARATION OF MECHA. BLK)
- 2) Disconnect the SOLENOID LEAD WIRES by soldering iron.
- 3) Remove the solenoid while releasing the SOLENOID FIXATION HOOK of solenoid.

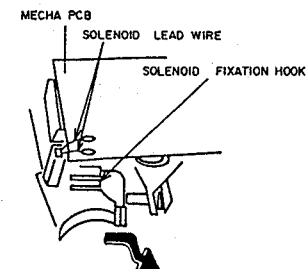

Fig. 4-9

V. MECHANICAL ADJUSTMENT

5-1. CONFIRMATION OF PINCH ROLLER PRESSURE

Put in PLAY mode. Push TAKE UP PINCH ROLLER arm down with the SPRING GAUGE 1 or 2 mm from the capstan, then release the pressure of the SPRING GAUGE and read the SPRING GAUGE at the moment the TAKE UP PINCH ROLLER touches to the capstan and begins to rotate.

Also confirm the SUPPLY PINCH ROLLER pressure as same manner as above.

Specified pressure

- TAKE UP PINCH ROLLER: 320 ± 50 gram
- SUPPLY PINCH ROLLER: 200 ± 40 gram

If the specified pressure is not obtained, replace the PINCH ROLLER SPRING.

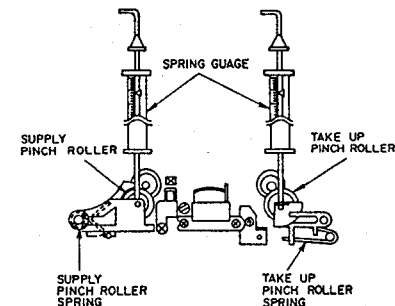

Fig. 5-1

5-2. CONFIRMATION OF WINDING TORQUE IN EACH MODE

Insert a CASSETTE TORQUE METER(AJ-751179) and measure in each mode. For fast forward and rewind, measure at the end of the tape when the tape has stopped running.

PLAY mode
 TAKE UP : 35 to 55 gram
 BACK TENSION : 4 to 7 gram
 FF and REW mode : 70 to 160 gram

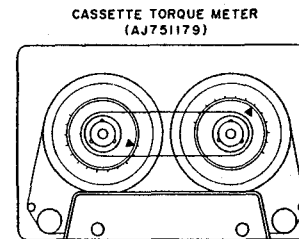

Fig. 5-2

5-3. TAPE SPEED ADJUSTMENT

- 1) Connect a frequency counter to LINE OUT, and playback a 3150 Hz test tape(AT-751263).
- 2) Adjust the tape speed control VR(Inside the capstan motor) by small flat screw driver so that the reading on the frequency counter is 3150 ± 10 Hz.

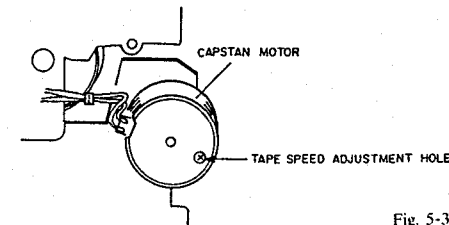

Fig. 5-3

5-4. TAPE GUIDE HEIGHT ADJUSTMENT

- 1) Set the MIRROR CASSETTE TAPE(AJ-751178) and set to PLAY mode.
- 2) Adjust the TAPE GUIDE (A) ADJUSTMENT ④ NUT so that the both space(A and A') on the erase head are equal.
- 3) Similarly turn the REC/PB HEIGHT ADJUSTMENT ③ and ③ SCREWS little by little so that the tape runs smoothly and no curl at the TAPE GUIDES (A) and (B).

※ TAPE GUIDE (A) HEIGHT ADJUSTMENT JIG
 Special nut is used in the tape guide (A) height adjustment nut ④. For easy adjustment, please make height adjustment nut driver by filing ordinary minus screw driver as shown Fig.5-4.

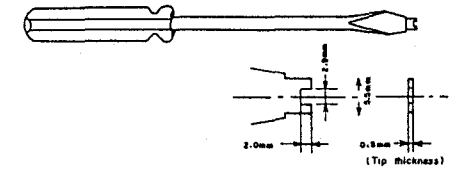

Fig. 5-4

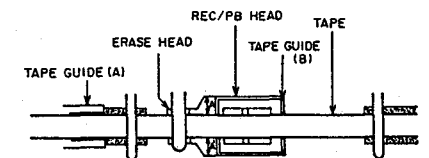

Fig. 5-5

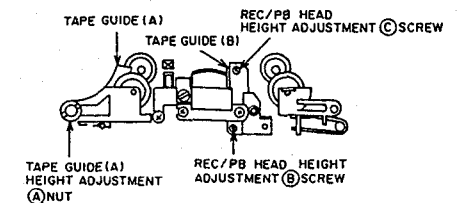

Fig. 5-7

5-5. REC/PB HEAD AZIMUTH ALIGNMENT ADJUSTMENT

- 1) Connect the AC milli-voltmeters to both L CH and R CH of the LINE OUT and connect CH 1 and CH 2 of oscilloscope to output terminals of AC milli-voltmeters.
- 2) Playback a 10 kHz, -15VU test tape(AT-750778) and adjust REC/PB HEAD AZIMUTH ALIGNMENT SCREW so that the reading on the AC milli-voltmeters are at maximum and waveforms on the oscilloscope are in the same phase.
- 3) For best result repeat 5-4. TAPE GUIDE HEIGHT ADJUSTMENT and 5-5. REC/PB HEAD AZIMUTH ALIGNMENT ADJUSTMENT for several times.
- 4) After adjustment paint lock the adjustment SCREWS and NUT.

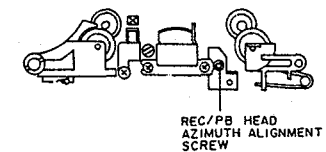

Fig. 5-6

VI. ELECTRICAL ADJUSTMENT

[PRECAUTIONS BEFORE ADJUSTMENT]

- Before adjustment, clean and de-magnetize the heads and tape guides.
- Set the switches and control knobs are as following, without specified.
 BIAS volume : CENTER(Click) position
 REC LEVEL volume : MAX.(10) position
 REC BALANCE volume : CENTER(Click) position
 DOLBY NR switch : OFF
 MPX FILTER switch : OFF
 CD DIRECT switch : OFF
- Input signal is supplied from LINE IN.
- Use the following recording test tapes.
 NORMAL position : MAXELL UDI 60
 CrO2 position : TDK SA 60
 METAL position : TDK MA 60

STEP	ADJUSTMENT ITEM
1.	TEST TAPE/INPUT SIGNAL
2.	MODE
3.	TEST POINT, ADJUSTMENT PART
4.	REMARKS
	* RESULT

TEST point Adjustment part

- | 9 METAL POSITION BIAS |
|------------------------------------------------------------------------|
| 1. 1kHz and 10kHz -29dBm(LINE OUT), METAL recording test tape. |
| 2. REC PLAY - PLAY(play back) |
| 3. LINE OUT, VR401 |
| 4. * Connect AC milli-voltmeter to LINE OUT. |
| * Play back level difference between 1kHz and 10kHz is 0 ± 0.3 dB. |

- | 7 NORMAL POSITION BIAS |
|------------------------------------------------------------------------|
| 1. 1kHz and 10kHz -29dBm(LINE OUT), NORMAL recording test tape. |
| 2. REC PLAY - PLAY(play back) |
| 3. LINE OUT, VR403(L CH)/VR403b(RCH) |
| 4. * Connect AC milli-voltmeter to LINE OUT. |
| * Play back level difference between 1kHz and 10kHz is 0 ± 0.3 dB. |

- | 5 BIAS OSC FREQUENCY |
|-------------------------------------------------------------|
| 1. CrO2 recording test tape |
| 2. REC PLAY |
| 3. P401 pin \odot , T401 |
| 4. * Connect frequency counter between pin \odot and GND. |
| * 100.0 ± 0.2 kHz |

- | 8 CrO2 POSITION BIAS |
|------------------------------------------------------------------------|
| 1. 1kHz and 10kHz -29dBm(LINE OUT), CrO2 recording test tape. |
| 2. REC PLAY - PLAY(play back) |
| 3. LINE OUT, VR402 |
| 4. * Connect AC milli-voltmeter to LINE OUT. |
| * Play back level difference between 1kHz and 10kHz is 0 ± 0.3 dB. |

- | 6 HX-PRO RESONANCE FREQUENCY |
|------------------------------------------------------|
| 1. METAL recording test tape |
| 2. REC PLAY |
| 3. TP1(+) and TP2(-), T402 and T402b |
| 4. * Connect DC voltmeter between TP1(+) and TP2(-). |
| * Reading on the DC voltmeter is at minimum. |

- | 10 RECORDING LEVEL |
|-----------------------------------------------|
| 1. NORMAL Blank Tape |
| 2. REC - PLAY |
| 3. VR303(L CH), VR303b(R CH) |
| 4. * Connect AC milli-volt meter to LINE OUT. |
| * -6.0 ± 0.3 dBm |

- | 2 PLAYBACK LEVEL |
|----------------------------------------------|
| 1. 315Hz test tape(AT-750773) |
| 2. PLAY |
| 3. LINE OUT, VR201(L CH)/VR201b(R CH) |
| 4. * Connect AC milli-voltmeter to LINE OUT. |
| * -6.0 ± 0.2 dBm |

- | 3 PLAYBACK EQUALIZER |
|----------------------------------------------|
| 1. 10kHz test tape(AT-750778) |
| 2. PLAY |
| 3. LINE OUT, VR202(L CH)/VR202b(R CH) |
| 4. * Connect AC milli-voltmeter to LINE OUT. |
| * -21.0 ± 0.3 dBm |

- | 4 MPX FILTER |
|-----------------------------------------------------|
| 1. 19kHz -6.0dBm(LINE OUT, MPX FILTER switch "OFF") |
| 2. REC PAUSE, MPX FILTER switch "ON". |
| 3. LINE OUT, FL301(L CH)/FL301b(R CH) |
| 4. * Connect AC milli-voltmeter to LINE OUT. |
| Minimum output level(Less than -36dBm) |

- | 1 LEVEL METER SENSITIVITY |
|-------------------------------------------------------------------|
| 1. 1kHz -4.5dBm(LINE OUT), NORMAL recording test tape |
| 2. REC PAUSE |
| 3. LEVEL METER, VR502(L CH)/VR502b(R CH) |
| 4. * White segments on the level meter are completely turned "ON" |

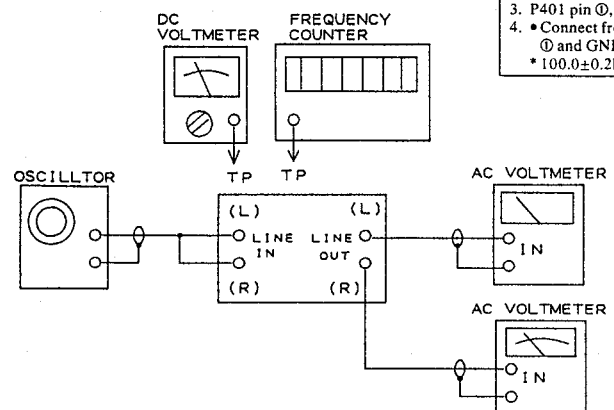
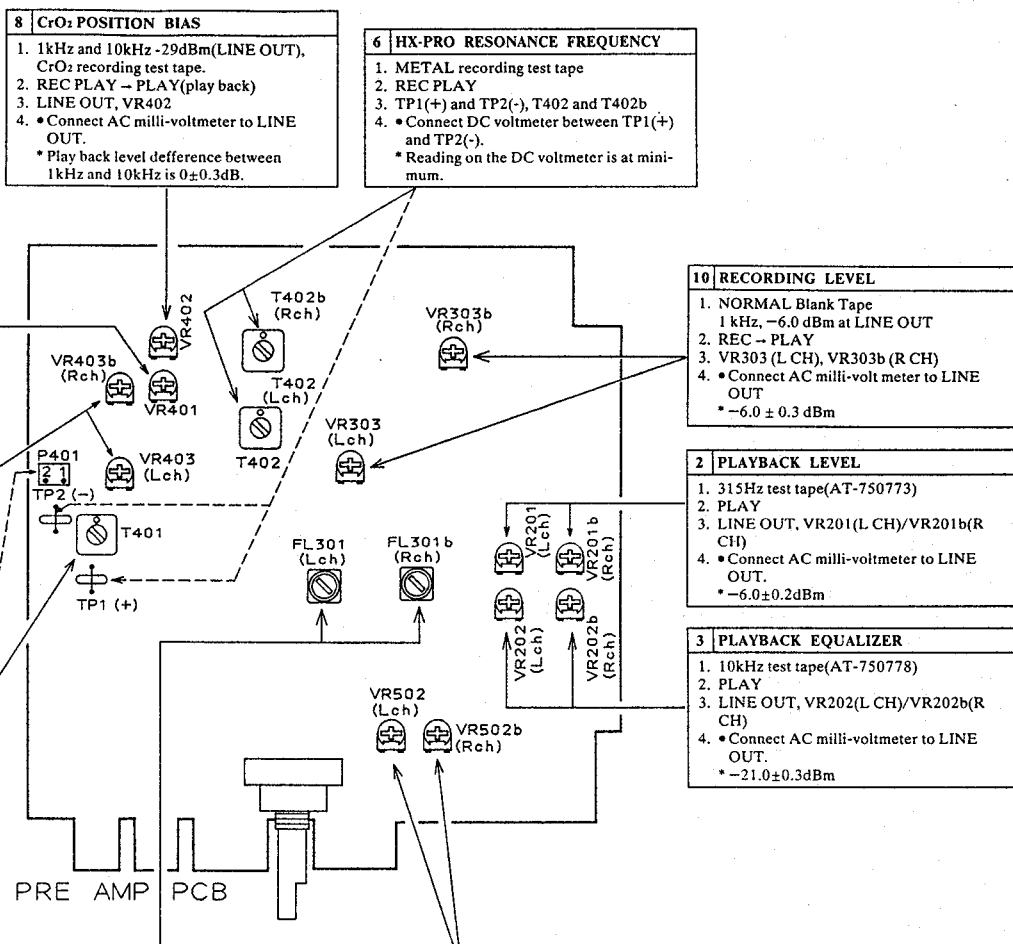

Fig.6-1 Instrument connection



VII. PARTS LIST

ATTENTION

- When placing an order for parts, be sure to list Part No., Model No. and the description of each part. Otherwise, the non-delivery of the part or the delivery of a wrong part may result.
- Please make sure that Part No. is correct when ordering. If not, a part different from the one you ordered may be delivered.
- Since the parts shown in Parts List of Preliminary Service Manual may have been the subject of changes, please use this Parts List for all future reference.

HOW TO USE THIS PARTS LIST

- This Parts List lists those parts which are considered necessary for repairs. Other common parts, such as resistors and capacitors, are listed in the "Common List for Service Parts" from which these parts should be selected and stocked.
- The Recommended Spare Parts List shows those parts in the Parts List which are considered particularly important for service.
- Parts not shown in the Parts List and "Common List for Service Parts" will not in principle be supplied.
- How to read the Parts List.

a) Mechanism Block

2. HEAD BASE BLOCK

REF. NO.	PART NO.	DESCRIPTION
1	BH-T2023A320A	HEAD BASE BLOCK
2	HP-H2206A010A	HEAD R/P PR4-8FU C
3	ZS-477876	PAN20x03STL CMT
4	ZS-536488	BID20x08STL CMT
5	ZG-402895	SP CS ANGLE ADJUST

SP (Service Parts) Classification

This number corresponds with the individual parts index number in that figure.

b) PC Board

6. MAIN PC BOARD

REF. NO.	PART NO.	DESCRIPTION
IC1	EI-324536	IC HD14049BP
IC2	EI-336801	IC MB8841-564M
C1A	EC-338399	C MMY V 223M 250AC [U,E,B,S]
C1B	EC-350949	C MMY V 223M 250DC [J]
C1C	EC-338397	C MMY V 223M 125AC [C,A]
X1	EI-318384	OSC XTAL NC-18C

Symbols for primary destination

[A]: AAL (U.S.A) [S]: SAA (Australia)
 [B]: BEAB (England) [U]: U/T (Universal)
 [C]: CSA (Canada) Area
 [E]: CEE (Europe) [V]: VDE (W. Germany)
 [J]: JPN (Japan) [Y]: Custom Version

SP (Service Parts) Classification

These reference symbols correspond with component symbols in the Schematic Diagrams.

The available PC Board Blocks are listed separately.

- When Part No. is known, Parts Index at end of Parts List can be used to locate where that part is shown in Parts List by its Reference No. listed at right of Part No.

WARNING

Δ(*) INDICATES SAFETY CRITICAL COMPONENTS. FOR CONTINUED SAFETY, REPLACE SAFETY CRITICAL COMPONENTS ONLY WITH MANUFACTURE'S RECOMMENDED PARTS.

AVERTISSEMENT

Δ(*) IL INDIQUE LES COMPOSANTS CRITIQUES DE SÉCURITÉ. POUR MAINTENIR LE DEGRÉ DE SÉCURITÉ DE L'APPAREIL, NE REMPLACER QUE DES PIÈCES RECOMMANDÉES PAR LE FABRICANT.

1. RECOMMENDED SPARE PARTS

We suggest you to stock the following Recommended Spare Part items listed below since they can cover most of the routine service.

Ref. No.	Part No.	Description
1	BB-T2118A040B	MECHA BLK GX-65
2	BH-729542J	HEAD BLK GX-Z6100
3	BM-729455J	MOTOR CAPSTAN SHE2L55(GX-Z6100)
4	BM-729478J	MOTOR REEL PART SGE09009
5	*BT-391564J	TRANS POW T2118 BS [B,S]
6	*BT-391563J	TRANS POW T2118 E [E]
7	*BT-391561J	TRANS POW T2118 U [U]
8	ED-389252J	D LED SLR-54VRSF RED
9	ED-307572	D SILICON H 1S5131
10	*ED-389840J	D SILICON 1SH139-100HS F10
11	ED-346573	D ZENER H HZ22-1L
12	ED-346583	D ZENER H HZ30-3L
13	ED-346598	D ZENER H HZ4 C2
14	ED-346602	D ZENER H HZ5 B3
15	ED-343410	D ZENER H HZ6A1L
16	ED-346525	D ZENER H HZ6A3L
17	ED-346532	D ZENER H HZ7A3L
18	ED-351418	D ZENER H HZ7B1L
19	ED-346538	D ZENER H HZ9A2L
20	ED-346546	D ZENER H HZ9C3L
21	*EF-368701	FUSE BET T 250V 250MA [B]
22	*EF-358641	FUSE BET T 250V 800MA [B]
23	*EF-399906	FUSE SEMKO T 250V 250MA [E,S]
24	*EF-258344	FUSE SEMKO T 250V 800MA [E,S]
25	*EF-309387	FUSE TSC A 250V 1.00A [U]
26	*EF-309389	FUSE TSC A 250V 400MA [U]
27	EH-370972	FILTER LC LP 370972
28	EI-367572	IC BA15218
29	EI-373980	IC BA15218N
30	EI-337845	IC BA6146
31	EI-353421	IC BA6229
32	EI-384868J	IC BU4030B
33	EI-359985	IC CX20187
34	EI-356327	IC HA12067NT
35	EI-345765	IC LB1292
36	EI-389254J	IC M50743-123SP T2118
37	EI-360043	IC M5220P
38	EI-310036	IC TC4066BP
39	EI-373383	IC UPC1297CA
40	EI-372031	OSC CE W/C FCR8.0MC 8.0MHZ
41	EM-389253J	IND FL CP5388GR DOUBLE
42	EO-356809	COIL TUN 1 100Z-121 100.00KHZ
43	EO-323982	COIL TUN 1 100Z-431 100.00KHZ
44	EP-729487J	SOLENOID
45	ER-344129	R FUSE H S10 ERD2FC 1/4W 3300G
46	*ER-318248	R FUSE H S10 ERD2FC 1/4W 47R0G
47	*ER-307565	R FUSE H S10 ERD2FC 1/4W 6R8J
48	*ER-344161	R FUSE H S10 ERD2FC 1/4W 82R0G
49	ES-729477J	LEAF SW
50	*ES-371104	SW PUSH SDDL1 01-1 [POWER]
51	ES-389265J	SW PUSH SPUY33 3THROW
52	ES-729443J	SW ROTARY
53	ES-359606	SW SELECTOR JUH1420-0201 01-4 [U]
54	ES-370965	SW SLIDE SSSU02 1-01-03N [TIMER]
55	ES-349474	SW TACT SKHAM004A [COUNTER RESET]

Ref. No.	Part No.	Description
56	ET-381637J1	DETECTOR GP1U521X [REMOTE SENSOR]
57	ET-373982	TR DT143ZS
58	ET-393897	TR DT114ES
59	ET-354371	TR DT124ES
60	ET-373391	TR DT143ZS
61	ET-370310	TR DT144TS
62	ET-729486J	TR PHOT NJL5161FKI B
63	ET-347738	TR ZSA1282A E,F F05
64	ET-352726	TR ZSA1392 T,U
65	ET-389808J	TR ZSA933S R,S
66	ET-389837J	TR ZSC1740S S F05
67	ET-389251J	TR ZSC1740S S F05
68	ET-308977	TR ZSC2274K F F05
69	ET-365394	TR ZSC2242A E,F,G F05
70	ET-378524J	TR ZSC3383 S,T,U
71	ET-379239	TR ZSD1380 Q,R
72	ET-389802J	TR ZSD2159 V F05
73	*EW-363680	AC CORD 200 LCFL B250 A B [B]
74	*EW-363655	AC CORD 200 0129AVFF B250 A UT [U]
75	*EW-363668	AC CORD 200 0364 LCFL B250 A EV [E]
76	*EW-363694	AC CORD 220 0436 LCFL B250 A S [S]
77	HE-729469J	HEAD E 876-30-03
78	HR-H2408A010A	HEAD COMB RP4-10TG RP4-10TG
79	MB-729506J	BELT
80	MB-729451J	BELT CAPSTAN
81	MI-729448J	FLYWHEEL
82	MI-729453J	FLYWHEEL
83	MP-729460J	PINCH ROLLER
84	MP-729472J	PINCH ROLLER
85	MR-729484J	PULLEY BRAKE (S) PART (BK)
86	MR-729482J	PULLEY BRAKE (T) PART(WH)
87	MR-729505J	PULLEY PART
88	MT-729492J	REEL TABLE (S)
89	MT-729493J	REEL TABLE (T)
90	MZ-729442J	CAM
91	MZ-729441J	GEAR ASSIST
92	MZ-729475J	GEAR IDLER

MECHA BLOCK

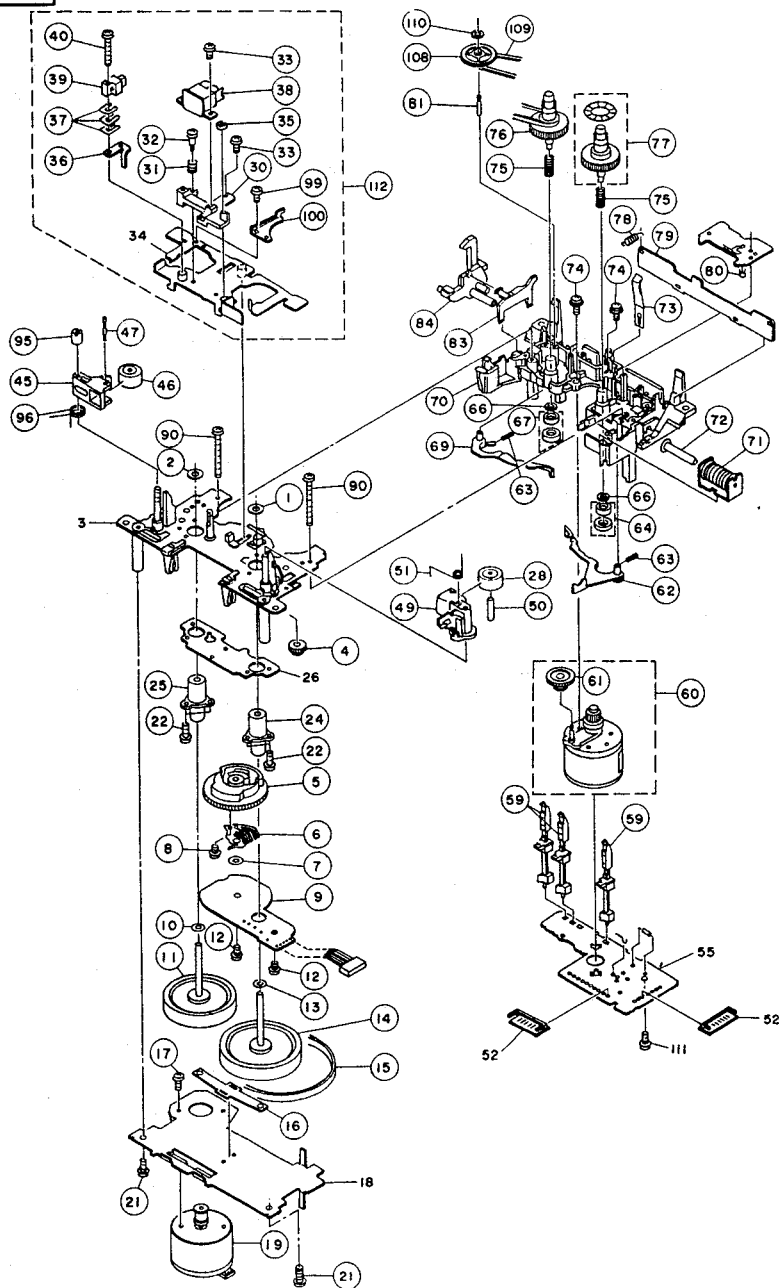

2. MECHA BLOCK

Ref. No.	Part No.	Description
1	ZW-729545J	TW25
2	ZW-729440J	TW22
4	MZ-729441J	GEAR ASSIST
5	MZ-729442J	CAM
6	ES-729443J	SW ROTARY
7	ZW-729444J	WASHER 30X080X050 PSL
8	ZS-729445J	PAN 20X03
9	EA-729446J	PC CONTROL
10	ZW-729447J	WASHER
11	MI-729448J	FLYWHEEL
12	ZS-729449J	PAN 20X30
13	ZW-729450J	WASHER 26X047X050 PSL
14	MI-729453J	FLYWHEEL
15	MB-729451J	BELT CAPSTAN
16	MZ-729452J	HOLDER THRUST
17	ZS-729454J	PAN 26X03
19	BM-729455J	MOTOR CAPSTAN SHE2L55(GX-Z6100)
21	ZS-729456J	SCREW TAPPING 26X08
22	ZS-729457J	ST PAN 20X08
24	MV-729458J	MAIN CASE (L)
25	MV-729459J	MAIN CASE (R)
28	MP-729460J	PINCH ROLLER
30	HZ-729461J	BASE HEAD
31	ZG-729462J	SP AZIMUTH
32	MS-729463J	SHAFT
33	ZS-729464J	ST PAN 26X04
35	ZW-729466J	NUT ADJ
36	HZ-729467J	BASE E HEAD
37A	ZW-729468J	SPACER
37B	ZW-729465J	SPACER
37C	ZW-729546J	SPACER
38	HR-H2408A010A	HEAD COMB RP4-10TG RP4-10TG
39	HE-729469J	HEAD E 876-30-03
40	ZS-729470J	BID 20X12
45	ML-729471J	ARM PINCH ROLLER (S)
46	MP-729472J	PINCH ROLLER
47	MS-729473J	SHAFT PINCH ROLLER
49	ML-729474J	ARM PINCH ROLLER (R)
50	MS-729475J	SHAFT PINCH ROLLER
51	ZG-729476J	SP ARM PINCE ROLLER (R)
59	ES-729477J	LEAF SW
60	BM-729478J	MOTOR REEL PART SGE09009
61	MZ-729479J	GEAR IDLER
62	ML-729480J	LEVER ASSIST (A)
63	ZG-729481J	SP LEVER ASSIST
64	MR-729482J	PULLEY BRAKE (T) PART(WH)
66	ZW-729483J	WASHER 26X055X013(PSL)
67	MR-729484J	PULLEY BRAKE (S) PART (BK)
69	ML-729485J	LEVER ASSIST (B)
70	TC-729486J	CHASSIS SUB SME2351
71	EP-729487J	SOLENOID
72	MS-729488J	SHAFT SOLENOID
73	ZG-729489J	SP PLATE CASSETTE HOLDER
74	ZS-729490J	SCREW SPECIAL 26X016
75	ZG-729491J	SP REEL TABLE
76	MT-729492J	REEL TABLE (S)
77	MT-729493J	REEL TABLE (T)
78	ZG-729494J	SP PULL CASSETTE PLATE
79	MZ-729495J	PLATE HOLDER CASSETTE
80	ET-729496J	TR PHOT NLS161FKI B
81	MS-729497J	SHAFT PULLEY
83	ML-729498J	LEVER
84	ML-729499J	LEVER EJECT
90	ZS-729500J	PAN 26X30
95	ZS-729501J	SCREW ADJ ARM PINCH ROLER
96	ZG-729502J	SP PINCH ROLER (S)
99	ZS-729503J	PAN 20X025
100	MZ-729504J	STOPPER
108	MR-729505J	PULLEY PART
109	MB-729506J	BELT
110	ZW-729507J	WASHER
112	BH-729542J	HEAD BLK GX-Z6100

NOTE:
Parts will not be supplied if they are not listed in the parts list, even if they appear on the assembling illustrations with reference No.

3. P.C BOARD BLOCK

Ref. No.	Part No.	Description
1A	BA-T2118A020B	PC(#1) PRE AMP BLK GX-65(U)[U]
1B	BA-T2118A020C	PC(#1) PRE AMP BLK GX-65(E)[E,B,S]
2	BA-T2118A030B	PC(#1) SYSCON BLK GX-65

PC (#) PRE AMP BLK CONSISTS OF FOLLOWING P.C BOARD

- PRE AMP P.C BOARD
- POWER SW P.C BOARD
- HEAD PHONE P.C BOARD

PC (#) SYS CON BLK CONSISTS OF FOLLOWING P.C BOARD.

- SYS CON P.C BOARD
- TIMER SW P.C BOARD

4. PRE AMP P.C BOARD

Ref. No.	Part No.	Description
C201	EC-393223J	C MC V T05 FM 121J 500DC
C412	EC-427948	C MC V FM 100J 500DC
C414	EC-347247	C MC V F05 FM 101J 500DC
C807	EC-363490	C EC V CUT SME 222M 16.0DC
C808	EC-375358	C EC V CUT SME 103M 16.0DC
D201	ED-351418	D ZENER H HZ7B1L
D202	ED-351418	D ZENER H HZ7B1L
D301	ED-307572	D SILICON H 1SS131
D302	ED-307572	D SILICON H 1SS131
D303	ED-307572	D SILICON H 1SS131
D701	ED-346538	D ZENER H HZ8A2L
D702	ED-346538	D ZENER H HZ8A2L
D703	ED-346573	D ZENER H HZ22-4L
D704	ED-346583	D ZENER H HZ30-3L
D705	ED-346525	D ZENER H HZ6A3L
D706	ED-346546	D ZENER H HZ8C3L
D707	ED-307572	D SILICON H 1SS131
D801	*ED-389840J	D SILICON 1SR139-100HS F10
D802	*ED-389840J	D SILICON 1SR139-100HS F10
D803	*ED-389840J	D SILICON 1SR139-100HS F10
D804	*ED-389840J	D SILICON 1SR139-100HS F10
D805	*ED-389840J	D SILICON 1SR139-100HS F10
D806	*ED-389840J	D SILICON 1SR139-100HS F10
D807	*ED-389840J	D SILICON 1SR139-100HS F10
D808	*ED-389840J	D SILICON 1SR139-100HS F10
D809	*ED-389840J	D SILICON 1SR139-100HS F10
D810	*ED-389840J	D SILICON 1SR139-100HS F10
D811	*ED-389840J	D SILICON 1SR139-100HS F10
D812	ED-343410	D ZENER H HZ6A1L
D813	*ED-389840J	D SILICON 1SR139-100HS F10
D814	ED-346602	D ZENER H HZ5 B3
D822	ED-346598	D ZENER H HZ4 C2
D823	ED-346532	D ZENER H HZ7A3L
D825	ED-307572	D SILICON H 1SS131
FL201	EO-356809	COIL TUN 1 100Z-121 100.00KHZ
FL301	EH-370972	FILTER LC LP 370972
FL302	EO-323982	COIL TUN 1 100Z-431 100.00KHZ
FR401	*ER-307565	R FUSE H S10 ERD2FC 1/4W 6R8J
FR701	*ER-344161	R FUSE H S10 ERD2FC 1/4W 82R0G
FR702	*ER-318248	R FUSE H S10 ERD2FC 1/4W 47R0G
FR703	ER-344129	R FUSE H S10 ERD2FC 1/4W 3300G
IC201	EI-360043	IC M5220P
IC202	EI-359985	IC CX20187
IC301	EI-359985	IC CX20187
IC302	EI-367572	IC BA1521B
IC306	EI-310036	IC TC4066BP
IC401	EI-373383	IC UPC1297CA
IC501	EI-373980	IC BA15218N
IC601	EI-384868J	IC BU4030B
IC822	EI-353421	IC BA6229
J201	EJ-391777J	PIN J YKC21-0018A 4P
L201	EO-372996	COIL FIX 1 RC875 22J
L301	EO-372996	COIL FIX 1 RC875 22J
L302	EO-389896J	COIL FIX 1 RC875 562J
R506	ER-378672J	R OMF H S10 FS 1/2W 181J

Ref. No.	Part No.	Description
R507	ER-378672J	R OMF H S10 FS 1/2W 181J
R826	ER-322787	R CB H S10 FS RDS 1/4W 100U
SW601	ES-368265J	SW PUSH SPUY33 3THROW
TR201	ET-389251J	TR 25C1740S S F05
TR202	ET-352726	TR 25A1392 T,U
TR203	ET-378524J	TR 25C3983 S,T,U
TR301	ET-389251J	TR 25C1740S S F05
TR302	ET-389251J	TR 25C1740S S F05
TR303	ET-389251J	TR 25C1740S S F05
TR304	ET-389251J	TR 25C1740S S F05
TR305	ET-389251J	TR 25C1740S S F05
TR306	ET-389251J	TR 25C1740S S F05
TR308	ET-373382	TR DTA1432S
TR309	ET-373382	TR DTA1432S
TR310	ET-360399	TR DTC114TS
TR311	ET-389251J	TR 25C1740S S F05
TR312	ET-389803J	TR 25A930S R,S
TR313	ET-389251J	TR 25C1740S S F05
TR401	ET-389802J	TR 2SD2159 V F05
TR402	ET-354371	TR DTC124ES
TR403	ET-370310	TR DTC144TS
TR404	ET-370310	TR DTC144TS
TR405	ET-308977	TR 25C2274K F F05
TR406	ET-308977	TR 25C2274K F F05
TR407	ET-389837J	TR 25C1740S E F05
TR408	ET-389837J	TR 25C1740S E F05
TR409	ET-373391	TR DTC1432S
TR701	ET-365394	TR 25C3242A E,F,G F05
TR702	ET-347738	TR 25A1282A E,F F05
TR703	ET-379239	TR 25D1380 Q,R
TR704	ET-389251J	TR 25C1740S S F05
TR705	ET-389802J	TR 2SD2159 V F05
TR706	ET-378524J	TR 25C3983 S,T,U
TR801	ET-389251J	TR 25C1740S S F05
TR821	ET-353897	TR DTC114ES
TR823	ET-389802J	TR 2SD2159 V F05
TR824	ET-353897	TR DTC114ES
TR825	ET-389802J	TR 2SD2159 V F05
TR826	ET-353897	TR DTC114ES
TR827	ET-389802J	TR 2SD2159 V F05
TR828	ET-353897	TR DTC114ES
T401	EO-389245J	COIL OSC 1 T2118 100.0KHZ
T402	EO-389266J	COIL OSC 1 2118 811116036 100K
VR201	EV-356575	R S-FIX H RH0615C 0.10W 222
VR202	EV-362115	R S-FIX H RH0615C 0.10W 153
VR301	EV-389259J	VR ROTARY RK163110IEAA W254 [REC BALANCE]
VR302	EV-389260J	VR ROTARY RK16Y12B0 104X2 [REC LEVEL]
VR303	EV-358829	R S-FIX H RH0615C 0.10W 223
VR401	EV-356577	R S-FIX H RH0615C 0.10W 103
VR402	EV-358861	R S-FIX H RH0615C 0.10W 683
VR403	EV-356679	R S-FIX H RH0615C 0.10W 682
VR404	EV-389258J	VR ROTARY RK1631110 B102 [BIAS]
VR501	EV-389262J	VR ROTARY RK16312A0 A503X2 [PHONES LEVEL]
VR502	EV-356582	R S-FIX H RH0615C 0.10W 473
F1A	*EF-309389	FUSE TSC A 250V 400MA [U]
F1B	*EF-339906	FUSE SEMKO T 250V 250MA [E,S]
F1C	*EF-368701	FUSE BET T 250V 250MA [B]
F2A	*EF-309389	FUSE TSC A 250V 400MA [U]
F2B	*EF-339906	FUSE SEMKO T 250V 250MA [E,S]
F2C	*EF-368701	FUSE BET T 250V 250MA [B]
F3A	*EF-309387	FUSE TSC A 250V 1.00A [U]
F3B	*EF-258344	FUSE SEMKO T 250V 800MA [E,S]
F3C	*EF-358641	FUSE BET T 250V 800MA [B]
F4A	*EF-309387	FUSE TSC A 250V 1.00A [U]

Ref. No.	Part No.	Description
F4B	*EF-258344	FUSE SEMKO T 250V 800MA [E,S]
F4C	*EF-358641	FUSE BET T 250V 800MA [B]

5. POWER SW P.C BOARD

Ref. No.	Part No.	Description
C801A	*EC-320548	C CE V F 103Z 250AC [U]
C801B	*EC-338411	C CE V DE7 FZ 103P 400AC [E,S,B]
SW801	*ES-371104	SW PUSH SDDL01 01-1 [POWER]

6. HEAD PHONE P.C BOARD

Ref. No.	Part No.	Description
J501	EJ-369995	PHONE J 3P HLJ0540-410 GP 6.3 [PHONES]

7. SISCON P.C BOARD

Ref. No.	Part No.	Description
D101	ED-307572	D SILICON H 1SS131
D102	ED-307572	D SILICON H 1SS131
D103	ED-307572	D SILICON H 1SS131
IC101	EI-389254J	IC M50743-123SP T2118
IC102	EI-356327	IC HA12067NT
IC103	EI-345765	IC LB1292
IC104	EI-345765	IC LB1292
IC105	EI-345765	IC LB1292
IC106	EI-345765	IC LB1292
IN101	EM-389253J	IN D FL CP5386GR DOUBLE
RM101	ET-381637J1	DETECTOR GP1U521X [REMOTE SENSOR]
TR101	ET-389251J	TR 25C1740S S F05
TR102	ET-373391	TR DTC1432S
TS101	ES-349474	SW TACT SKHHAM004A [COUNT RESET]
TS104	ES-349474	SW TACT SKHHAM004A [E,FASC]
TS105	ES-349474	SW TACT SKHHAM004A [REI]
TS106	ES-349474	SW TACT SKHHAM004A [PLAE]
TS107	ES-349474	SW TACT SKHHAM004A [FF]
TS108	ES-349474	SW TACT SKHHAM004A [REC PAUSE]
TS109	ES-349474	SW TACT SKHHAM004A [STOP]
TS110	ES-349474	SW TACT SKHHAM004A [REC MUTE]
TS111	ES-349474	SW TACT SKHHAM004A [MONITOR]
X101	EI-372031	OSC CE W/C FCR8.0MC 8.0MHZ

8. TIMER SW P.C BOARD

Ref. No.	Part No.	Description
SW101	ES-370965	SW SLIDE SSSU02 1-01-03N [TIMER]

10. METER DRIVE P.C BOARD

Ref. No.	Part No.	Description
IC850	EI-337845	IC BA6146

FINAL ASSEMBLY BLOCK

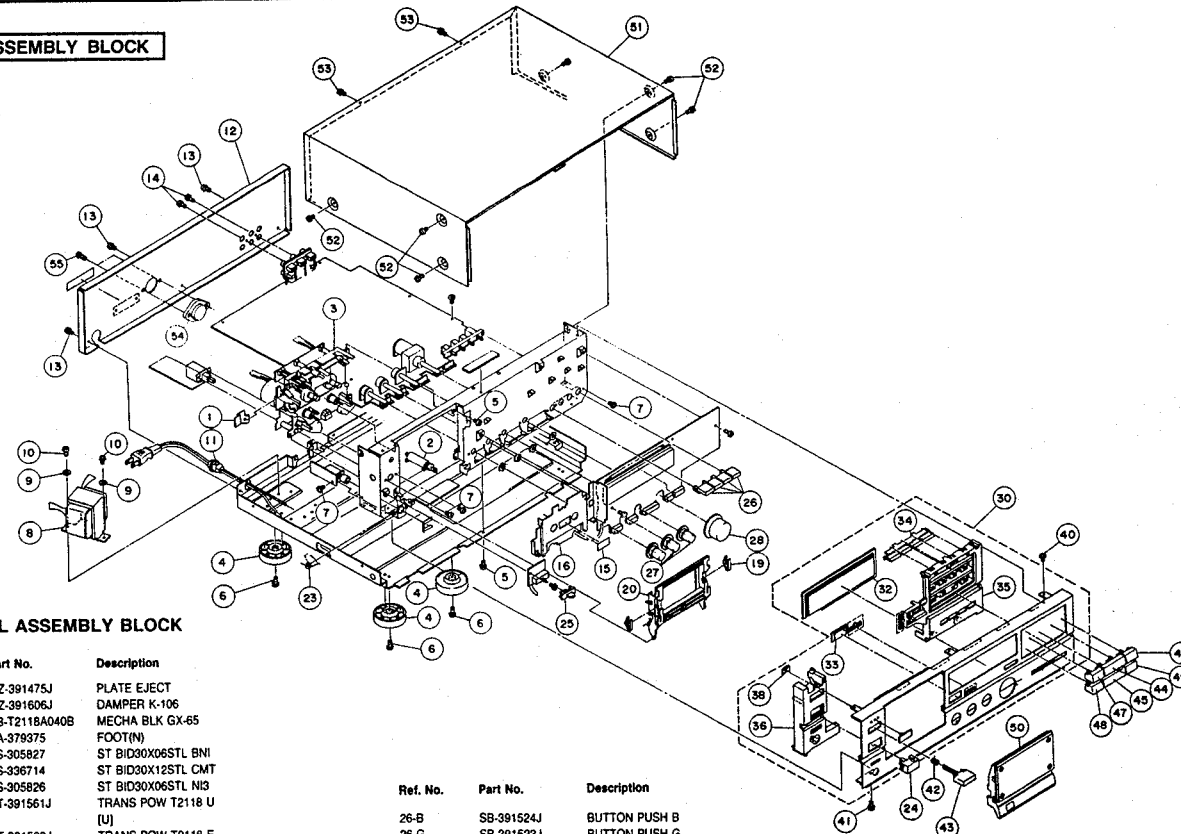

11. FINAL ASSEMBLY BLOCK

Ref. No.	Part No.	Description
1	MZ-391475J	PLATE EJECT
2	MZ-391606J	DAMPER K-106
3	BB-T2118A040B	MECHA BLK GX-65
4	SA-378375	FOOT(N)
5	ZS-305827	ST BID30X06STL BNI
6	ZS-336714	ST BID30X12STL CMT
7	ZS-305826	ST BID30X06STL NI3
8A	*BT-391561J	TRANS POW T2118 U
	[U]	
8B	*BT-391563J	TRANS POW T2118 E
	[E]	
8C	*BT-391564J	TRANS POW T2118 BS
	[B,S]	
9	ZW-273914	SW40
10	ZS-322580	ST BID40X08STL BNI
11A	*EW-363655	AC CORD 200 0129AVFF B250 A UT
	[U]	
11B	*EW-363668	AC CORD 200 0364 LCFL B250 A EV
	[E]	
11C	*EW-363680	AC CORD 200 LCFL B250 A B
	[B]	
11D	*EW-363694	AC CORD 220 0436 LCFL B250 A S
	[S]	
12A	SP-391496J	PANEL REAR GX-65(U)
	[U]	
12B	SP-391497J	PANEL REAR GX-65(E)
	[E,B]	
12C	SP-391499J	PANEL REAR GX-65(B,S)
	[S]	
13	ZS-358953	ST BID30X08STL BNI
14	ZS-331532	PT BID30X08STL BNI
15	SZ-357722	REFLECTOR
16	SP-391527J	DECORATION PLATE MECHA
19	ZG-336815	SP PLATE CASSETTE HOLDER (B)
20	TC-391477J	CASSETTE CASE
23	ZG-391478J	SP TORSION CASSETTE
24-B	SK-373236B	KNOB POWER-B
24-G	SK-373236A	KNOB POWER-G
25-B	SK-391526J	KNOB SLIDE B
25-G	SK-391525J	KNOB SLIDE G

Ref. No.	Part No.	Description
26-B	SB-391524J	BUTTON PUSH B
26-G	SB-391523J	BUTTON PUSH G
27-B	SK-391517J	KNOB VR B
27-G	SK-391516J	KNOB VR G
28-B	SK-391611J	KNOB REC (2) PART
28-G	SK-391612J	KNOB REC (3) PART
30-B	BD-T2118A060A	PANEL FRONT BLK GX-65-B
30-G	BD-T2118A060C	PANEL FRONT BLK GX-65-G
32	SE-391502J	WINDOW METER
34-B	SK-384079J1	KNOB B
34-G	SK-384078J1	KNOB G
35-B	SB-391491J	BUTTON OPERATE B
35-G	SK-391490J	BUTTON OPERATE G
38-B	SP-391534J	ESCUTCHEON SIDE B
38-G	SP-391533J	ESCUTCHEON SIDE G
40	ZS-305827	ST BID30X08STL BNI
41	ZS-331532	PT BID30X08STL BNI
42	ZG-392662J	SP PUSH OPEN
43-B	SB-391513J	BUTTON EJECT B
43-G	SB-391512J	BUTTON EJECT G
44-B	SB-391519J	BUTTON PLAY B
44-G	SB-391518J	BUTTON PLAY G
45-B	SK-381888J	KNOB OPERATION(A2) STOP B
45-G	SK-391122J	KNOB OPERATION(A2) STOP(T) G
46-B	SK-373337A	KNOB OPERATION(B) FF-BLACK
46-G	SK-391123J	KNOB OPERATION(B) FF(T) G
47-B	SK-373337C	KNOB OPERATION(B) REW-BLACK
47-G	SK-391114J	KNOB OPERATION(B) REW(T) G
48-B	SK-373337E	KNOB OPERATION(B) PAUSE-BLACK
48-G	SK-391115J	KNOB OPERATION(B) PAUSE(T) G
49-B	SK-373337G	KNOB OPERATION(B) MUTE B
49-G	SK-391117J	KNOB OPERATION(B) MUTE(T) G

Ref. No.	Part No.	Description
50-B	BD-T2118A070A	LID PANEL BLK GX-65-B
50-G	BD-T2118A070C	LID PANEL BLK GX-65-G
51-B	SP-391493J	COVER UPPER B
51-G	SP-391492J	COVER UPPER G
52-B	ZS-322580	ST BID40X08STL BNI
52-G	ZS-322570	ST BID40X08STL NI3
53	ZS-358963	ST BID30X08STL BNI
54	ES-359606	SW SELECTOR JUH1420-0201 01-4
	[U]	
55	ZS-361450	ST BID30X10STL CMT
	[U]	

NOTE:
Parts will not be supplied if they are not listed in the parts list, even if they appear on the assembling illustrations with reference No.

12. ACCESSORY

Ref. No.	Part No.	Description
1	EW-383168J	CORD TC-C-05S P-P 2P 2PCS

PARTS LIST

INDEX

Table with 8 columns: Part No., Ref. No., Part No., Ref. No., Part No., Ref. No., Part No., Ref. No. containing a comprehensive list of parts and their reference numbers.

PARTS LIST

Table with 8 columns: Part No., Ref. No., Part No., Ref. No., Part No., Ref. No., Part No., Ref. No. containing a comprehensive list of parts and their reference numbers.

PARTS LIST

AKAI

MODEL **GX-65**

SCHEMATIC DIAGRAMS AND PC BOARDS

TABLE OF CONTENTS

1. POWER SW PC BOARD	2
2. CONNECTION DIAGRAM	3
3. SYSCON AND OTHER PC BOARDS	4
4. SYSCON SCHEMATIC DIAGRAM	5
5. PRE AMP SCHEMATIC DIAGRAM	6
6. PRE AMP PC BOARD	7
7. BLOCK DIAGRAM	8
8. IC	9

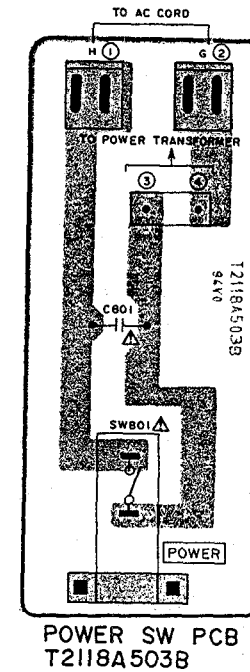

WARNING Δ INDICATES SAFETY CRITICAL COMPONENTS FOR CONTINUED SAFETY.
REPLACE SAFETY CRITICAL COMPONENTS ONLY WITH MANUFACTURER'S
RECOMMENDED PARTS.
AVERTISSEMENT: Δ IL INDIQUE LES COMPOSANTS CRITIQUES DE SÉCURITÉ.
POUR MAINTENIR LE DEGRÉ DE SÉCURITÉ DE L'APPAREIL,
NE REMPLACER QUE DES PIÈCES RECOMMANDÉES PAR LE FABRICANT

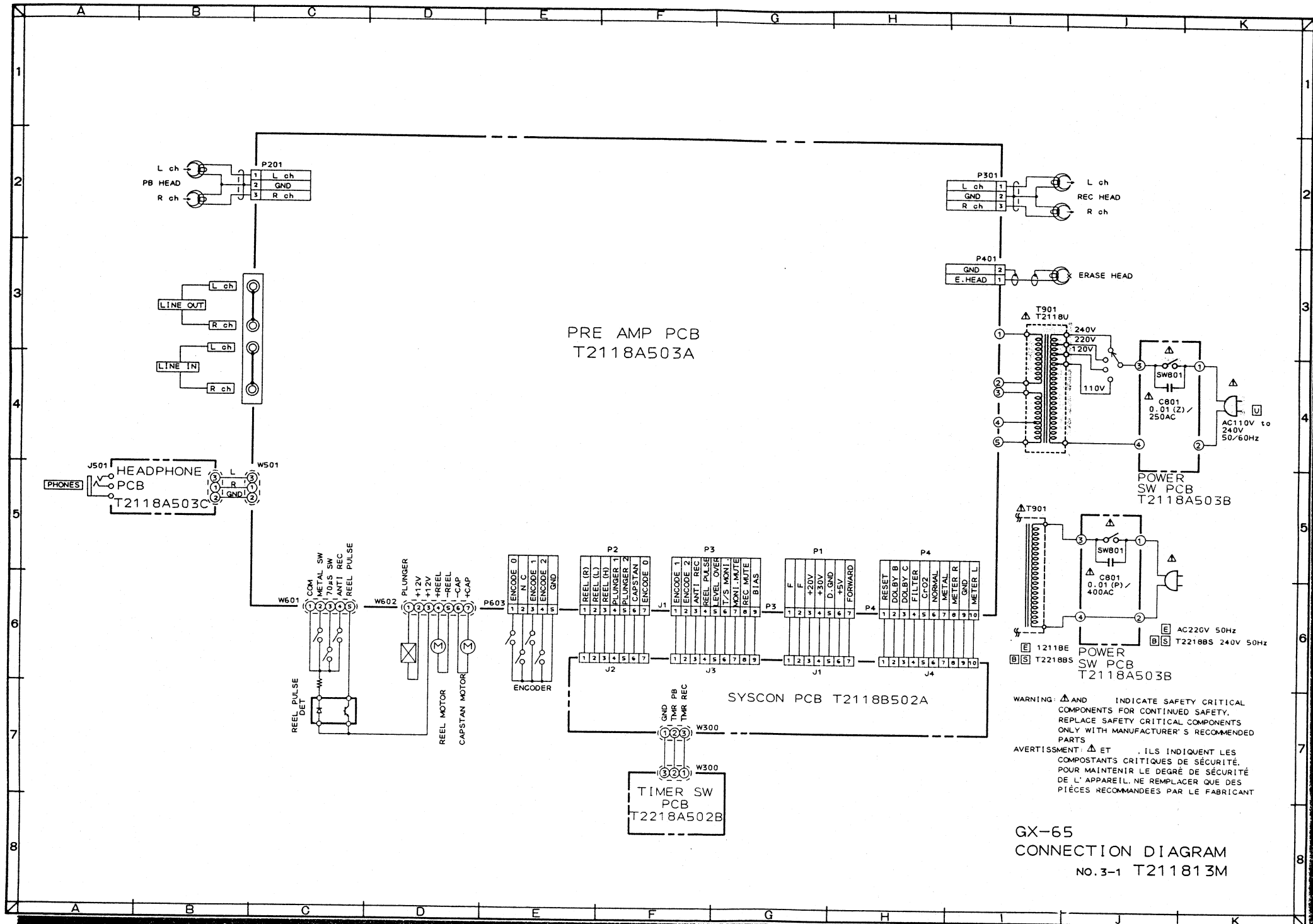

WARNING: ⚠ AND ⚡ INDICATE SAFETY CRITICAL COMPONENTS FOR CONTINUED SAFETY. REPLACE SAFETY CRITICAL COMPONENTS ONLY WITH MANUFACTURER'S RECOMMENDED PARTS.

AVERTISSEMENT: ⚠ ET ⚡ ILS INDIQUENT LES COMPOSANTS CRITIQUES DE SÉCURITÉ. POUR MAINTENIR LE DEGRÉ DE SÉCURITÉ DE L'APPAREIL, NE REMPLACER QUE DES PIÈCES RECOMMANDÉES PAR LE FABRICANT.

GX-65
 CONNECTION DIAGRAM
 NO. 3-1 T211813M

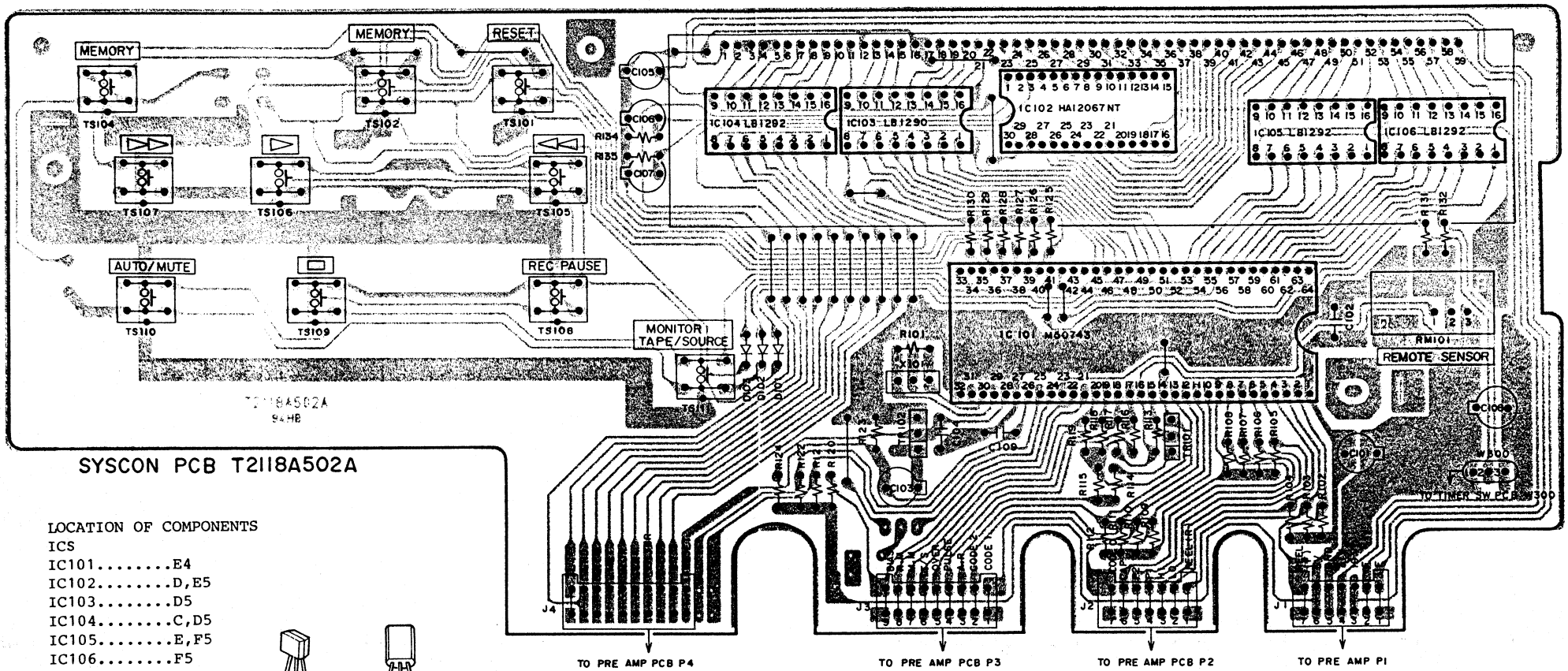

SYSCON PCB T2118A502A

LOCATION OF COMPONENTS

ICS

- IC101.....E4
- IC102.....D,E5
- IC103.....D5
- IC104.....C,D5
- IC105.....E,F5
- IC106.....F5

TRANSISTORS

- TR101.....E4
- TR102.....D3,4

CONNECTORS

- W100.....D3
- W200.....D3
- W300.....D3
- J1.....F3
- J2.....E3
- J3.....D3
- J4.....C3



DTC143ZS



2SC1740S

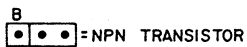

= NPN TRANSISTOR

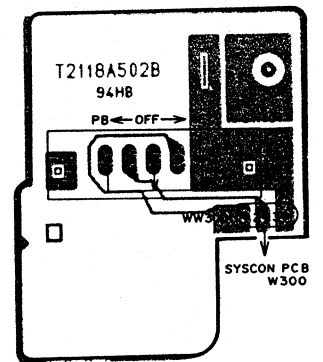

TIMER SW PCB
T2118A502B

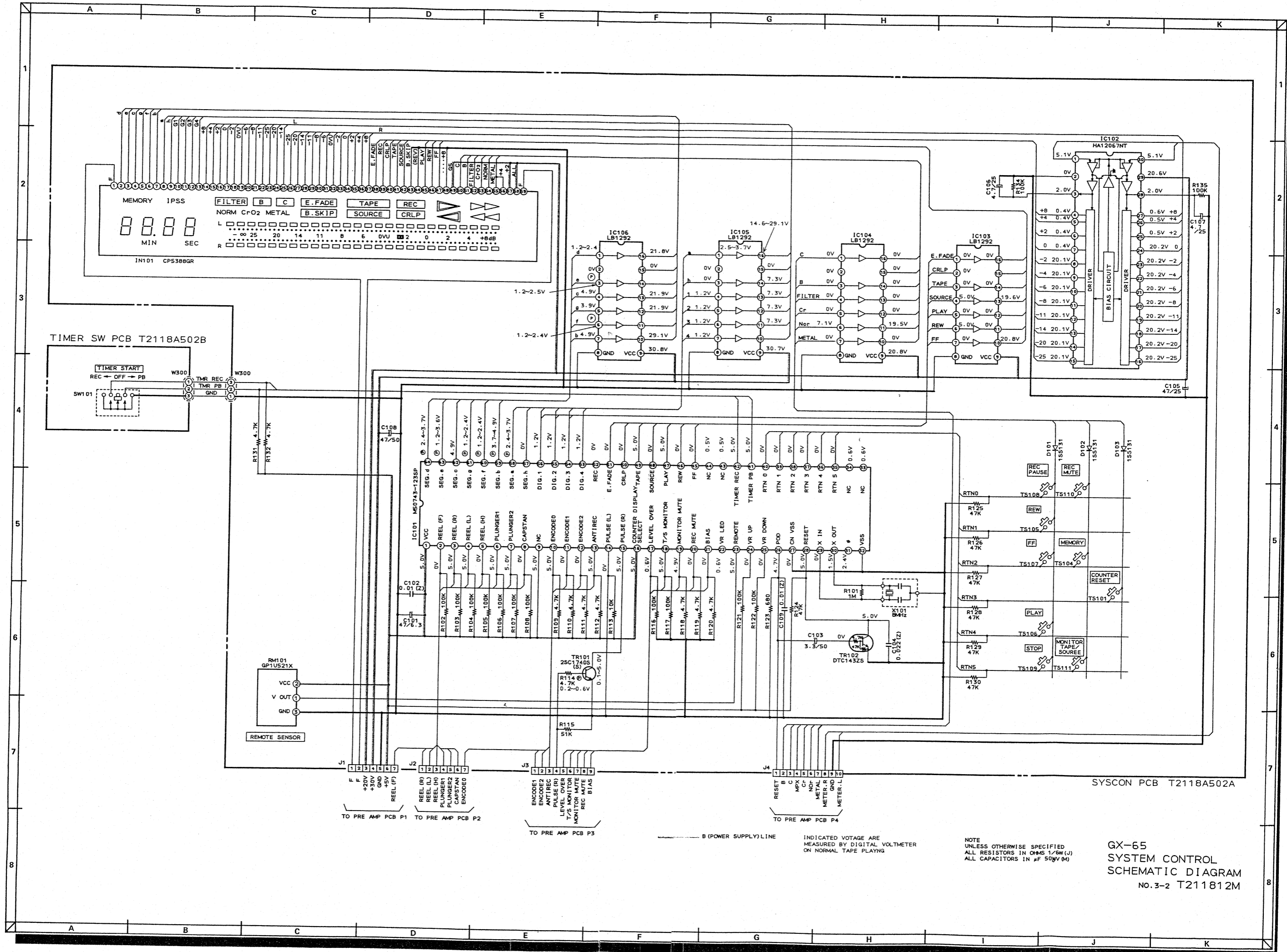

INDICATED VOLTAGE ARE MEASURED BY DIGITAL VOLTMETER ON NORMAL TAPE PLAYING

NOTE UNLESS OTHERWISE SPECIFIED ALL RESISTORS IN OHMS 1/8W(J) ALL CAPACITORS IN μ F 50V(M)

GX-65 SYSTEM CONTROL SCHEMATIC DIAGRAM NO. 3-2 T211812M

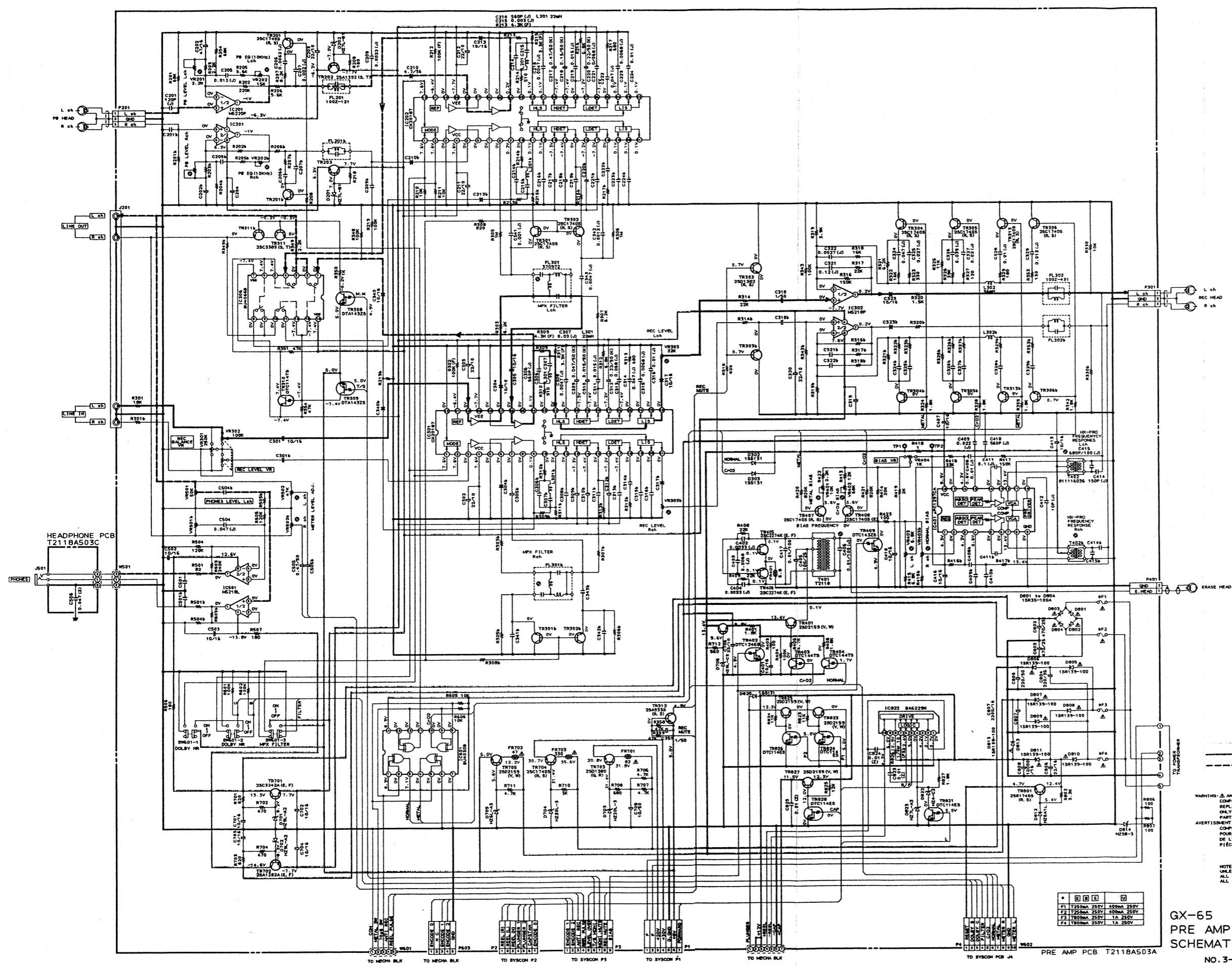

- - - - - 18 POWER SUPPLY LINE
 - - - - - 18 REC SIGNAL LINE
 - - - - - 18 PB MONITOR LINE
 MEASURED IN DC PLAY MODE

WARNING: Δ AND ∇ INDICATE SAFETY CRITICAL COMPONENTS FOR CONTINUED SAFETY. REPLACE SAFETY CRITICAL COMPONENTS ONLY WITH MANUFACTURER'S RECOMMENDED PARTS.
 AVERTISSEMENT: Δ ET ∇ ILS INDICENT LES COMPOSANTS CRITIQUES DE SÉCURITÉ. POUR MAINTENIR LE DEGRÉ DE SÉCURITÉ DE L'APPAREIL, NE REMPLACER QUE DES PIÈCES RECOMMANDÉES PAR LE FABRICANT.

NOTE: UNLESS OTHERWISE SPECIFIED ALL RESISTORS IN ΩMS 1/4W 1% ALL CAPACITORS IN #F 50V 90

RES	VAL	RES	VAL
F1	175ΩMA 250V 400MA 250V	F2	175ΩMA 250V 400MA 250V
F3	175ΩMA 250V 1A 250V	F4	175ΩMA 250V 1A 250V

GX-65
 PRE AMP
 SCHEMATIC DIAGRAM
 NO.3-3 T211811M

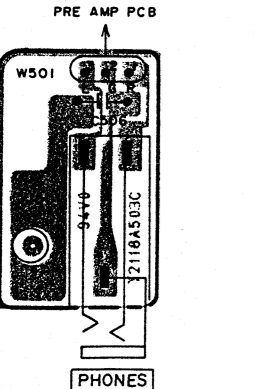
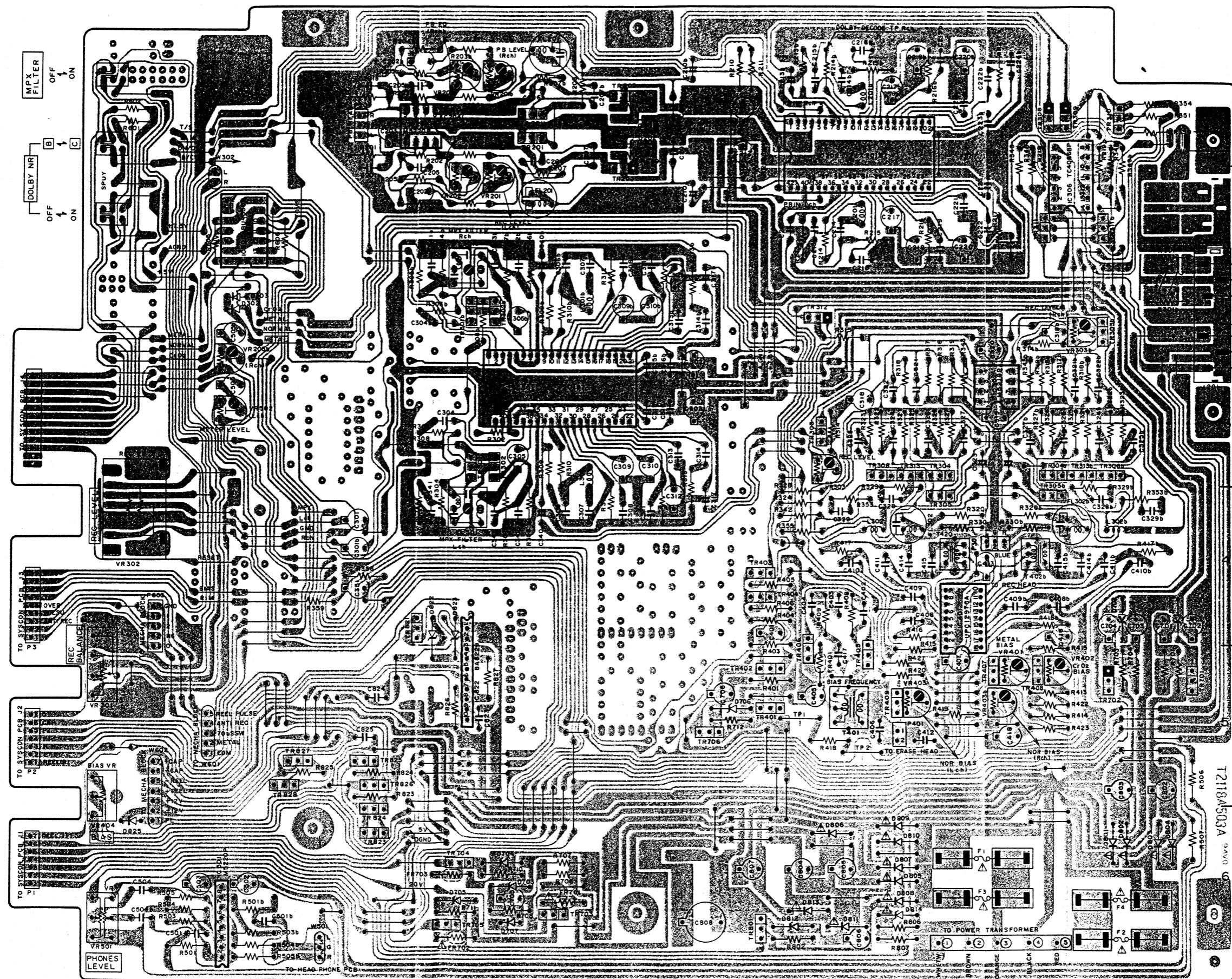

HEAD PHONE PCB
T2118A503C

PRE AMP PCB T2118A503A

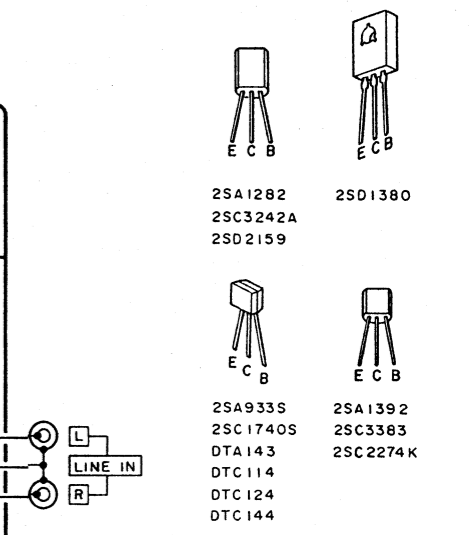

LOCATION OF COMPONENTS

ICS	
IC201	F1
IC202	C1,2
IC301	D,E3
IC302	B3
IC306	A,B1,2
IC401	B4
IC501	G6
IC601	G2
IC822	E4,5

TRANSISTOR	
TR201	E1
TR201b	E1
TR202	D1
TR203	D1
TR301	E3
TR302	E2
TR302b	E3
TR303	C3
TR303b	A2,3
TR304	B3
TR305	B4
TR306	C3
TR306b	A3
TR308	B1
TR309	B1
TR310	A1
TR311	B2
TR311b	A2
TR312	C2,3
TR313	B,C3
TR313b	A3
TR401	C,D5
TR402	C,D5
TR403	C,D4
TR404	C,D4
TR405	C4,5

CONNECTOR	
J201	A3
J501	A1
W301	A2, G1
W302	A2, G1
W501	A1, F6
W601	G5
W602	G5, 6
P1	H6
P2	H5
P3	H4
P4	H3
P201	F1
P301	B4
P401	C5
P603	G4,5

■ PNP TRANSISTOR
 □ NPN TRANSISTOR

WARNING: INDICATES SAFETY CRITICAL COMPONENTS FOR CONTINUED SAFETY. REPLACE SAFETY CRITICAL COMPONENTS ONLY WITH MANUFACTURER'S RECOMMENDED PARTS.
 AVERTISSEMENT: Δ IL INDIQUE LES COMPOSANTS CRITIQUES DE SÉCURITÉ. POUR MAINTENIR LE DEGRÉ DE SÉCURITÉ DE L'APPAREIL, NE REMPLACER QUE DES PIÈCES RECOMMANDÉES PAR LE FABRICANT.

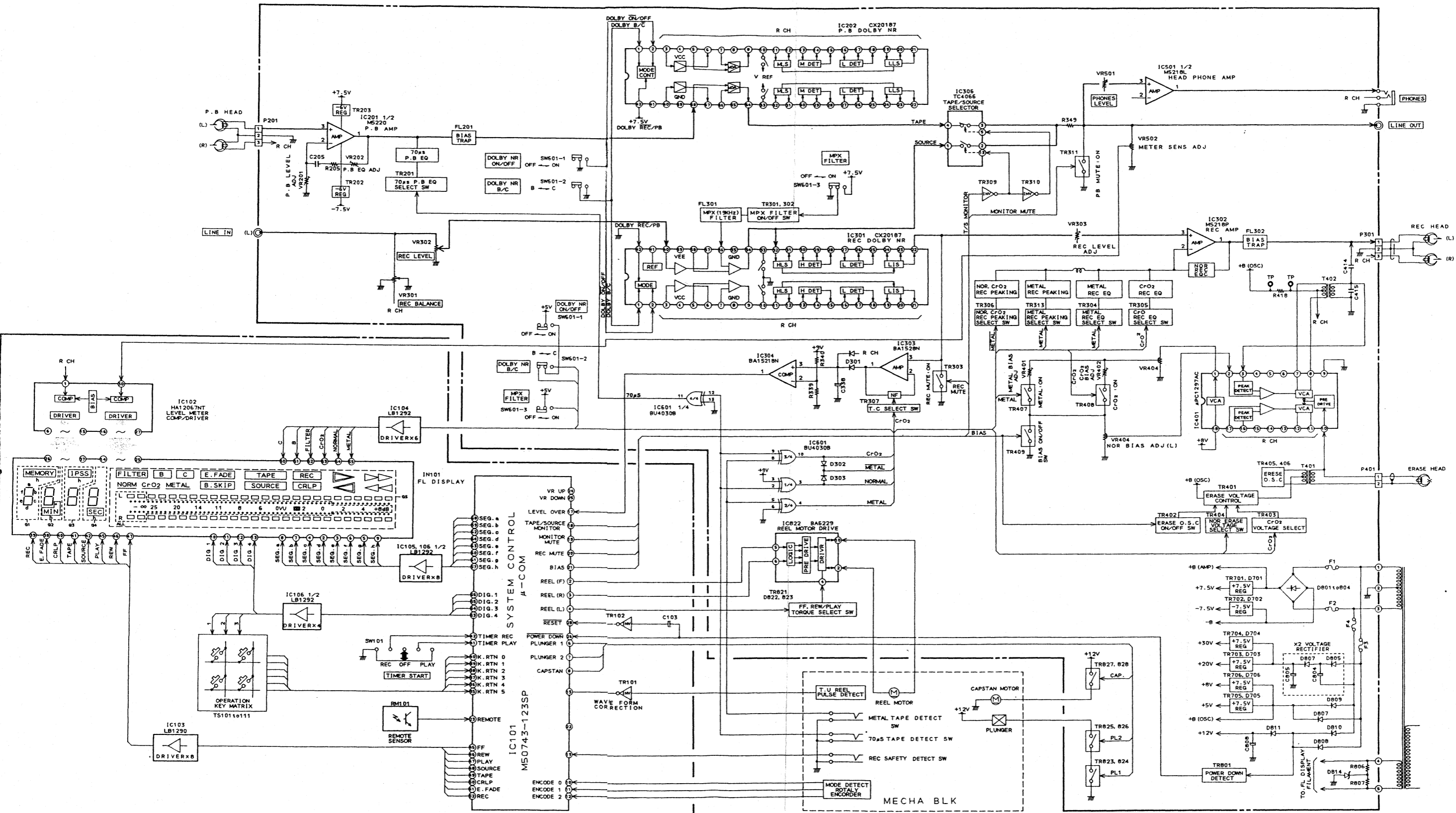

SYSTEM CONTROL P.C.B

PRE AMP PCB

GX-65
BLOCK DIAGRAM
NO. T211852M

M50743-123SP (SYSTEM CONTROL MI-COM)

Pin No.	SYMBOL	I/O	DESCRIPTION
1	Vcc		+5V
2	REEL(F)	O	Reel motor control output. L: Normal(FWD) direction
3	REEL(R)	O	Reel motor control output. L: Reverse(REV) direction
4	REEL(L)	O	Reel motor torque(Low) control output. H: PLAY, REC PLAY, MUTE PLAY mode L: Other mode
5	REEL(H)	O	Reel motor torque(High) control output. H: FF, REW, AUTO PLAY mode L: Other mode
6	PLUNGER 1	O	Plunger ON/OFF control output.
7	PLUNGER 2	O	L: Plunger ON(Active)
8	CAPSTAN	O	Capstan motor ON/OFF control output. L: capstan motor ON
9	NC		
10	ENCODER 0	I	Encode data(Mecha. mode) input *Refer to Fig. 1
11	ENCODER 1	I	
12	ENCODER 2	I	
13	ANTI REC	I	Anti recording control input. H: Inhibited recording mode
14	PULSE(L)		Not used
15	PULSE(R)	I	Take up pulse input.
16			Not used
17	LEVEL OVR	I	Level over input H: At source level is higher than proper level. (On CRLP mode, this "H" input make source signal level down)
18	T/S MONI	O	TAPE monitor/SOURCE monitor select control output. H: TAPE monitor, L: SOURCE monitor
19	MONI MUTE	O	Monitor signal mute control output. L: Monitor signal muted
20	REC MUTE	O	REC mute control output. L: REC mute ON
21	BIAS	O	Bias OSC ON/OFF control output. L: Bias OSC is ON
22	VR LED	O	REC volume LED ON/OFF control output. LED ON: In REC PAUSE, REC PLAY, REC MUTE mode LED FLICK(1 sec interval): CRLP system is ON LED FLICK(125 msec interval): VR down mode
23	REMOTE	I	Serial data input from remote control.
24	VR UP	O	REC VOLUME motor control output. L: VOLUME UP
25	VR DOWN	O	REC VOLUME motor control output. L: VOLUME DOWN
26	POD	I	Power down detect input. L: Power down detect
27	CNVss		GND
28	RESET		Reset input
29	Xin		Crystal connection terminals for clock OSC.
30	Xout		
31			Not used
32	Vss		GND

Pin No.	SYMBOL	I/O	DESCRIPTION
33			Not used
34			Not used
35	RTN 5	I	Key return data input from key matrix.
36	RTN 4	I	
37	RTN 3	I	
38	RTN 2	I	
39	RTN 1	I	
40	RTN 0	I	
41	TIMER PB	I	Timer playback control input. L: Into the playback mode when power is ON
42	TIMER REC	I	Timer recording control input. L: Into the recording mode when power is ON
43	NC		
44	NC		
45	FF	O	Control output forlighting ▷▷ on the FL display.
46	REW	O	Control output forlighting ◁◁ on the FL display.
47	PLAY	O	Control output forlighting ▷ on the FL display.
48	SOURCE	O	Control output forlighting SOURCE on the FL display.
49	TAPE	O	Control output forlighting TAPE on the FL display.
50	CRLP	O	Control output forlighting CRLP on the FL display.
51	EFADE	O	Control output forlighting E.FADE on the FL display.
52	REC	O	Control output forlighting REC on the FL display.
53	DIG 4	O	Grid select output for FLD and key scan signals for key matrix.
54	DIG 3	O	
55	DIG 2	O	
56	DIG 1	O	
57	SEG h	O	Control signals for lighting 7 segments(a to g) on the FL display
58	SEG a	O	
59	SEG b	O	
60	SEG f	O	
61	SEG g	O	
62	SEG c	O	
63	SEG e	O	
64	SEG d	O	

[Encode output and MECHA. mode]

Encoder	Mode	STOP FF REW	REC PAUSE	PLAY REC PLAY REC MUTE PLAY
Encoder 0		L	H	H
Encoder 1		H	H	L
Encoder 2		H	H	L

Fig. 1