

AKAI SERVICE MANUAL

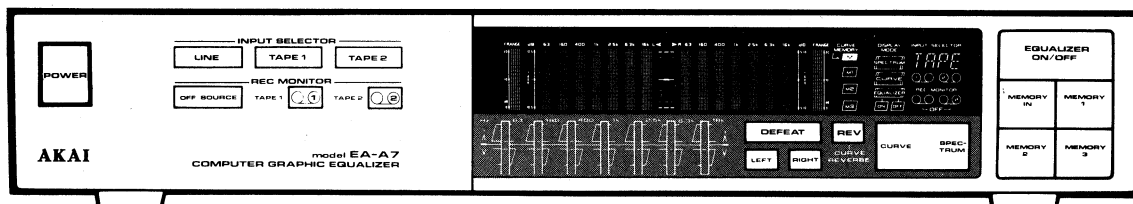

COMPUTER GRAPHIC EQUALIZER

MODEL **EA-A7**

ABBREVIATIONS FOR SERVICE MANUAL MODEL EA-A7

ABBREVIATION	EXPLANATION
AC	Alternating Current
BPF	Band Pass Filter
COMP	COMParetor
CPU	Central Processing Unit
EQ	EQUALizer
EVR	Electronic Variable Resistor
FLD	FLuorescent Display
REC	RECOrd
SW	SWitch

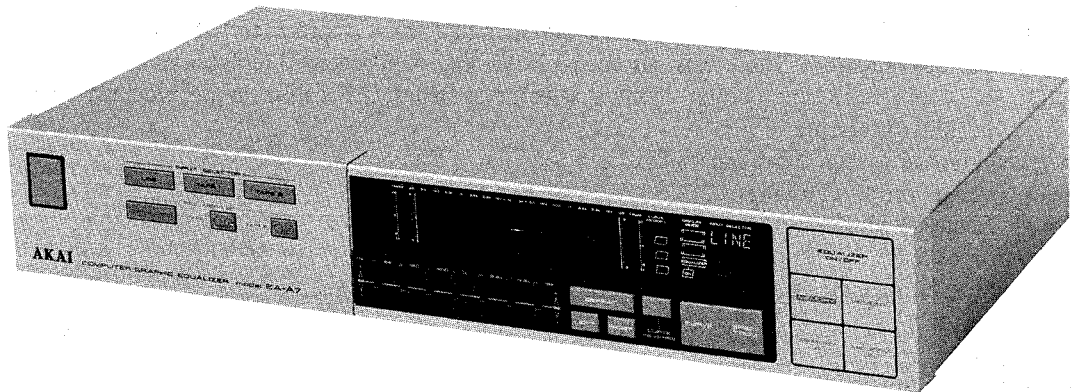

COMPUTER GRAPHIC EQUALIZER MODEL EA-A7

THIS MANUAL IS APPLICABLE TO BOTH SILVER AND BLACK PANEL MODEL

SECTION 1	SERVICE MANUAL	3
SECTION 2	PARTS LIST	9

SAFETY INSTRUCTIONS

SAFETY CHECK AFTER SERVICING

Confirm the specified insulation resistance between power cord plug prongs and externally exposed parts of the set is greater than 10 Mohms, but for equipment with external antenna terminals (tuner, receiver, etc.) and is intended for [C] or [A], specified insulation resistance should be more than 2.2 Mohms (ground terminals, microphone jacks, headphone jacks, line-in-out jacks etc.)

PRECAUTIONS DURING SERVICING

1. Parts identified by the Δ symbol parts are critical for safety.
Replace only with parts number specified.
2. In addition to safety, other parts and assemblies are specified for conformance with such regulations as those applying to spurious radiation. These must also be replaced only with specified replacements.
Examples: RF converters, tuner units, antenna selector switches, RF cables, noise blocking capacitors, noise blocking filters, etc.
3. Use specified internal wiring. Note especially:
 - 1) Wires covered with PVC tubing
 - 2) Double insulated wires
 - 3) High voltage leads
4. Use specified insulating materials for hazardous live parts. Note especially:
 - 1) Insulation Tape
 - 2) PVC tubing
 - 3) Spacers (Insulating Barriers)
 - 4) Insulation sheets for transistors
 - 5) Plastic screws for fixing microswitch (especially in turntable)
5. When replacing AC primary side components (transformers, power cords, noise blocking capacitors, etc.), wrap ends of wires securely about the terminals before soldering.

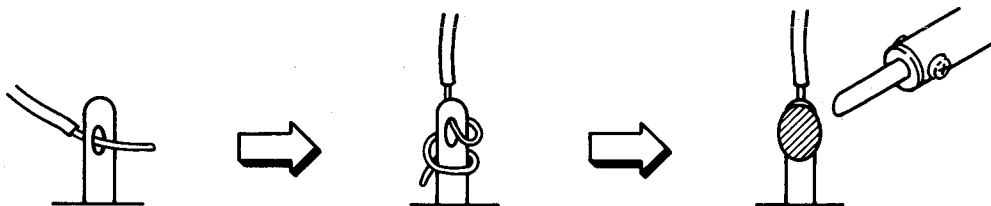

6. Observe that wires do not contact heat producing parts (heatsinks, oxide metal film resistors, fusible resistors, etc.).
7. Check that replaced wires do not contact sharp edged or pointed parts.
8. Also check areas surrounding repaired locations.
9. Use care that foreign objects (screws, solder droplets, etc.) do not remain inside the set.

VOLTAGE CONVERSION

Each machine is preset at the factory according to its destination, but some machine can be set to 110V, 120V, 220V or 240V as required. If your machine's voltage can be converted:

Before connecting the power cord, turn the **VOLTAGE SELECTOR** located on the rear panel with a screwdriver until the correct voltage is indicated. Models for USA, Canada, Europe, UK and Australia are not equipped with this facility.

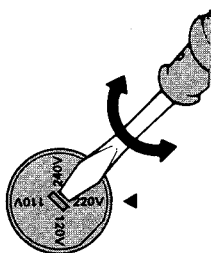

SECTION 1

SERVICE MANUAL

TABLE OF CONTENTS

I. SPECIFICATIONS	4
II. DISMANTRING OF UNIT	5
III. CONTROLS	6
IV. PRINCIPAL PARTS LOCATION	7
V. PC BOARD TITLES AND NUMBERS	8

For basic adjustments, measuring methods, and operating principles, refer to GENERAL TECHNICAL MANUAL.

I. SPECIFICATIONS

CENTER FREQUENCIES	63Hz/160Hz/400Hz/1kHz/2.5kHz/6.3kHz/16kHz
CONTROL RANGE	±10dB
INPUT SENSITIVITY/IMPEDANCE LINE IN	150mV/47k ohms
OUTPUT IMPEDANCE	500 ohms
S/N (IHF-A)	95dB
GAIN (Flat Position)	0dB
DISTORTION	0.03% (20Hz to 20kHz)
POWER REQUIREMENTS	100V, 50/60Hz for Japan 120V, 60Hz for USA & Canada 220V, 50Hz for Europe except UK 240V, 50Hz for UK and Australia 110V/120V/220V/240V, 50/60Hz switchable for other countries
DIMENSIONS	440 (W) × 70 (H) × 255 (D) mm (17.6 × 2.8 × 10.2 inches)
WEIGHT	3.3kg (7.3 lbs)

* For improvement purposes, specifications and design are subject to change without notice.

II. DISMANTLING OF UNIT

In case of trouble, etc. necessitating dismantling, please dismantle in the order shown in the photographs. Reassemble in reverse order.

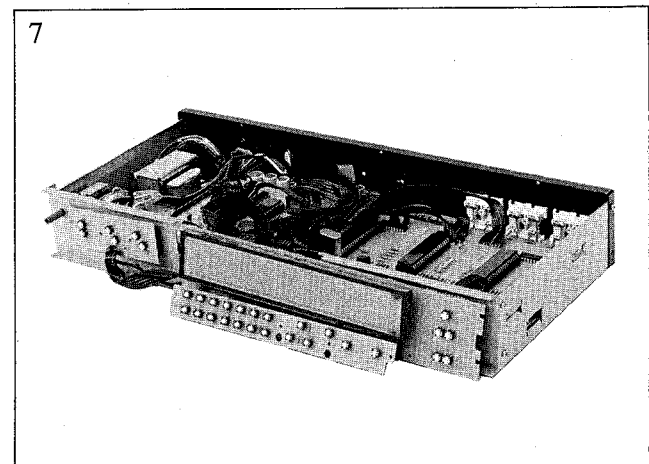
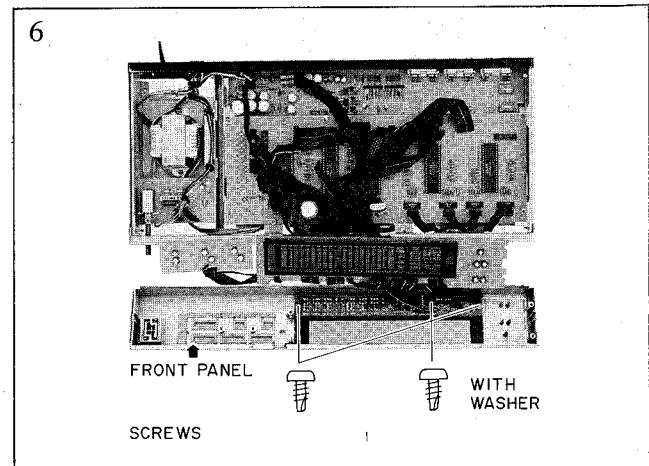
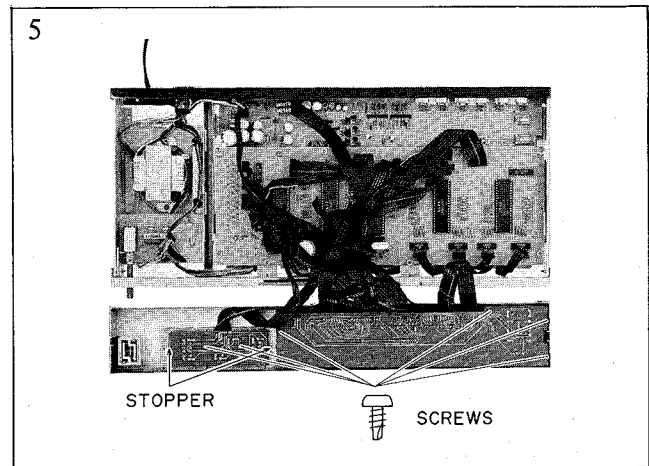
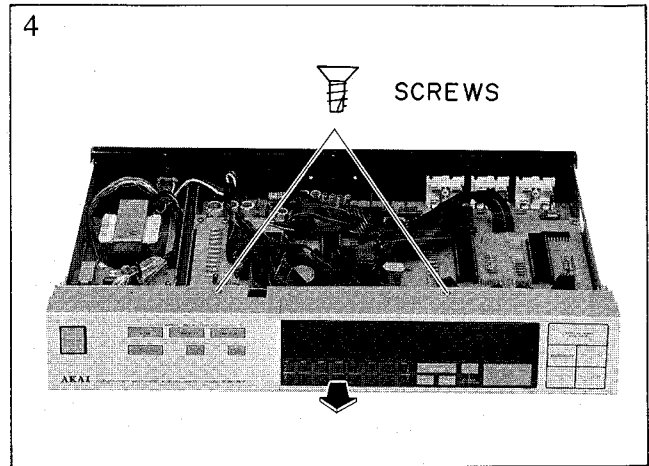
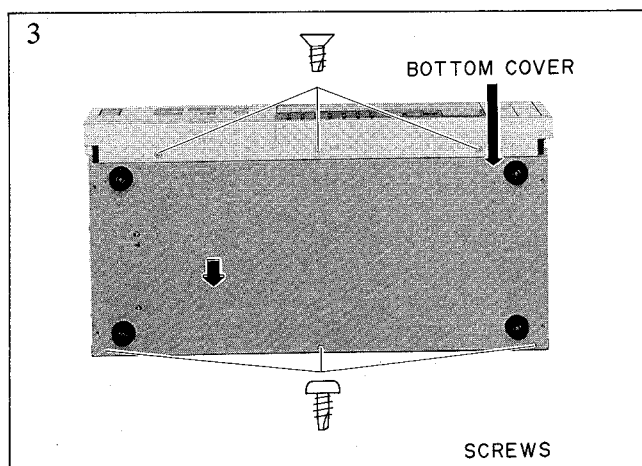
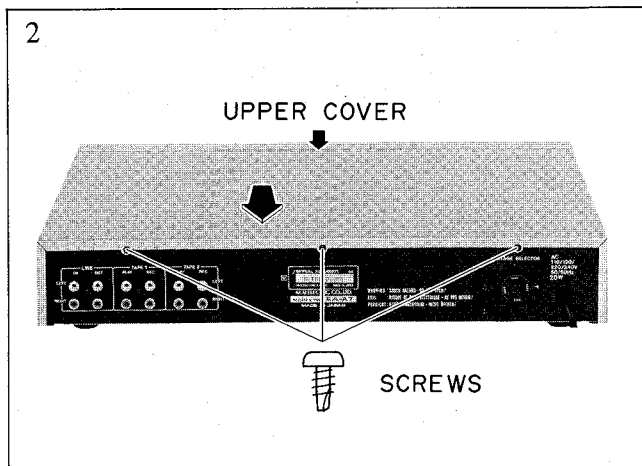
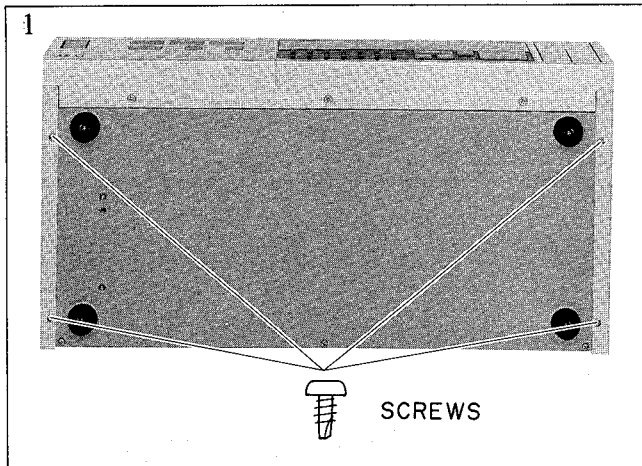

III. CONTROLS

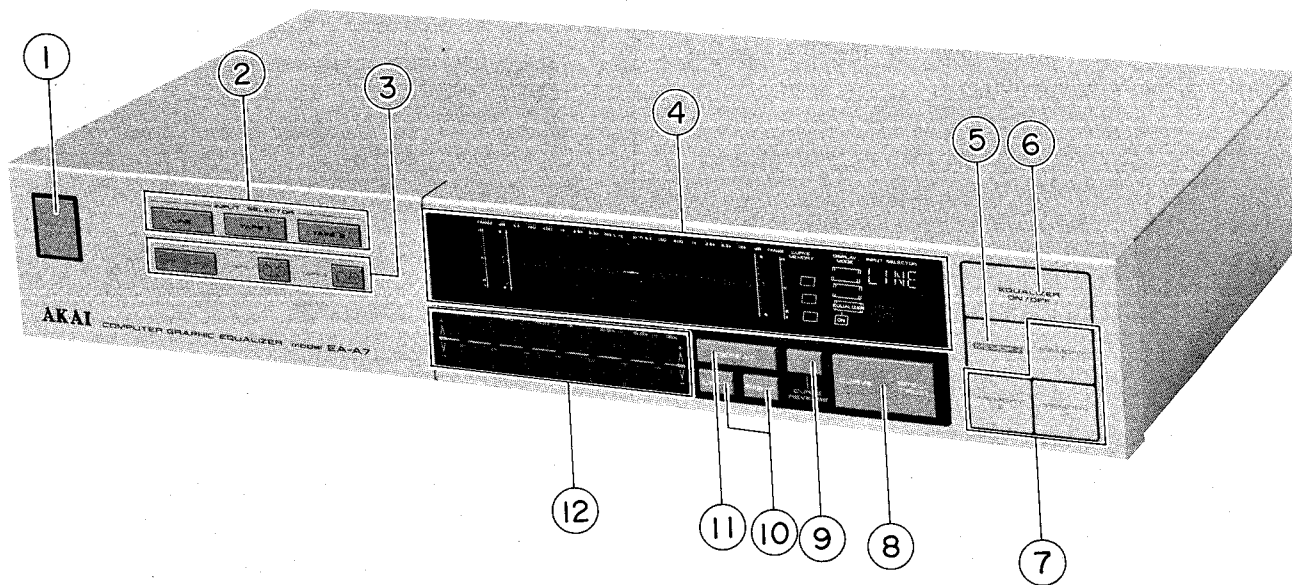

Fig. 3-1

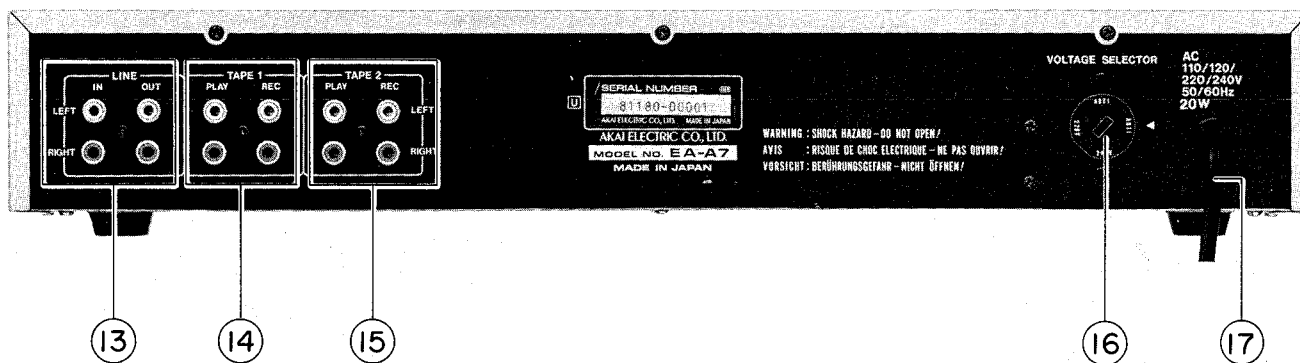

Fig. 3-2

- | | |
|--|---|
| 1. POWER SWITCH | 10. CHANNEL (LEFT/RIGHT) SELECTORS |
| 2. INPUT SELECTOR (LINE, TAPE1, TAPE2) | 11. DEFEAT BUTTON |
| 3. REC MONITOR (OFF (SOURCE), TAPE1,, TAPE2) | 12. FREQUENCY LEVEL CONTROL BUTTONS (+ and -) |
| 4. FL DISPLAY | 13. LINE (IN/OUT) JACKS |
| 5. MEMORY IN BUTTON | 14. TAPE1 (PLAY/REC) JACKS |
| 6. EQUALIZER ON/OFF BUTTON | 15. TAPE2 (PLAY/REC) JACKS |
| 7. MEMORY (1 to 3) BUTTONS | 16. VOLTAGE SELECTOR |
| 8. CURVE/SPECTRUM BUTTON | 17. POWER CORD |
| 9. CURVE REVERSE BUTTON | |

IV. PRINCIPAL PARTS LOCATION

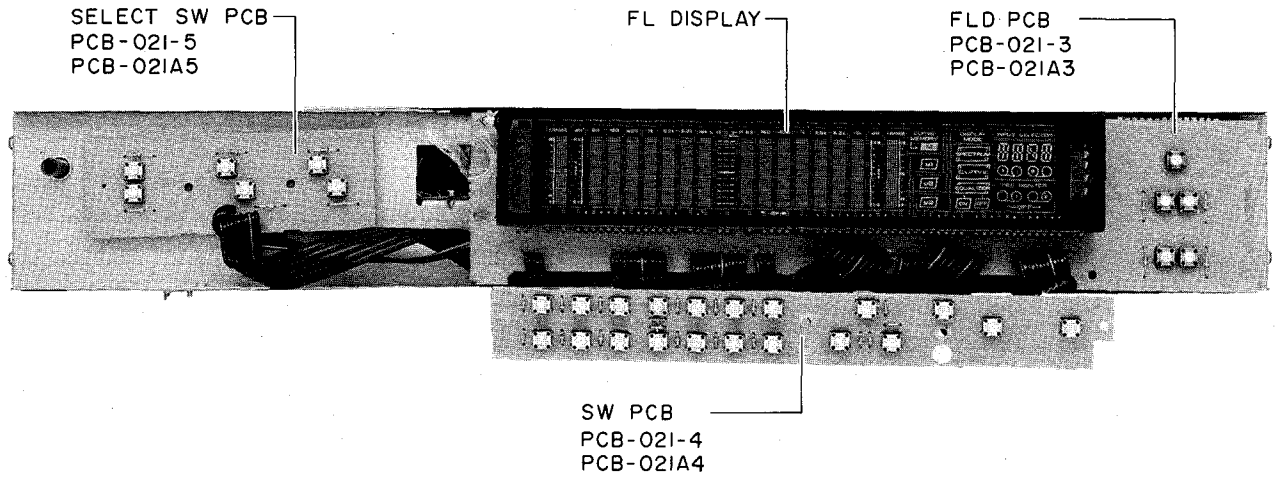

Fig. 4-1

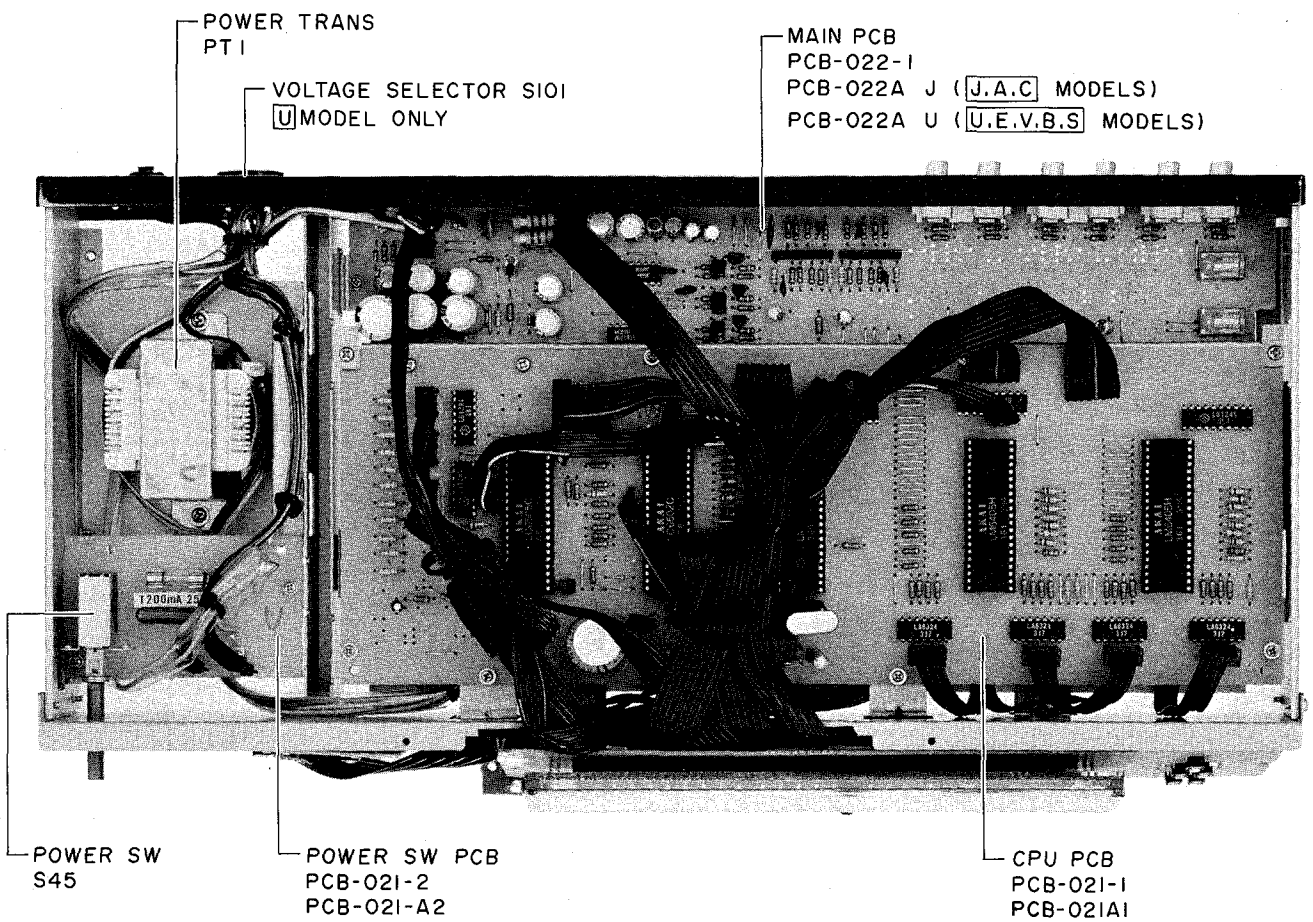

Fig. 4-2

V. PC BOARD TITLES AND NUMBERS

MODEL EA-A7 is employed two types of PC BOARDS shown in CHART – 1. Confirm your PC BOARD number when you repair the set.

PC BOARD TITLE		PC BOARD NUMBER
MAIN	PC BOARD	PCB-022A J <input type="text" value="J, A, C"/>
		PCB-022A U <input type="text" value="U, E, V, B, S"/>
		PCB-022-1
CPU	PC BOARD	PCB-021A1
		PCB-021-1
POWER SW	PC BOARD	PCB-021A2
		PCB-021-2
FLD	PC BOARD	PCB-021A3
		PCB-021-3
SW	PC BOARD	PCB-021A4
		PCB-021-4
SELECT SW	PC BOARD	PCB-021A4
		PCB-021-4

CHART – 1

SECTION 2

PARTS LIST

TABLE OF CONTENTS

RECOMMENDED SPARE PARTS	11
1. MAIN PC BOARD BLOCK	11
2. MICOM PC BOARD BLOCK	12
3. ASSEMBLY BLOCK	13
4. FINAL ASSEMBLY BLOCK	14
INDEX	15

Resistor and Capacitor which is not listed in this parts list, please refer to
COMMON LIST FOR SERVICE PARTS.

ATTENTION

1. When placing an order for parts, be sure to list the parts no., model no., and description. There are instances in which if any of this information is omitted, parts cannot be shipped or the wrong parts will be delivered.
2. Please be careful not to make a mistake in the parts no. If the parts no. is in error, a part different from the one ordered may be delivered.
3. Because parts number and parts unit supply in the Preliminary Parts List may be partially changed, please use this parts list for all future reference.

HOW TO USE THIS PARTS LIST

1. This Parts List shows the parts that are considered necessary for repairs. Other parts, such as resistors and capacitors, are shown in the "Common List for Service Parts". Select and order such parts from the "Common List for Service Parts".
2. The Recommended Spare Parts shows those parts in the Parts List which are considered particularly important for service.
3. Parts not shown in the Parts List and "Common List for Service Parts" will not be supplied in principle.
4. How to read list
 - a) Mechanism Block
 - b) P.C Board Block

2. HEAD BASE BLOCK

REF. NO.	PARTS NO.	DESCRIPTION
2-1x	BH-T2023A320A	HEAD BASE BLOCK GX-F66R
2-2	HP-H2206A010A	HEAD R/P PR4-8FU C
2-3	ZS-477876	PAN20x03STL CMT
2-4	ZS-536488	BID20x08STL CMT
2-5	ZG-402895	CS ANGLE ADJUST SPRING

SP (Service Parts) Classification
 A small "x" indicates the inability to show that particular part in the Photo or Illustration.
 This number corresponds with the individual parts index number in that figure
 This number corresponds with the Figure Number

6. SYS. CON. P.C BOARD BLOCK

REF. NO.	PARTS NO.	DESCRIPTION
6-1	BA-T2034A070A	PC SYS CON BLK GX-F44R
6-IC1	EI-324536	IC HD14049BP
6-IC2	EI-336801	IC MB8841-564M
6-IC3	EI-331661	IC SN7405N
6-IC4	EI-336725	IC M54527P
6-TR1to4	ET-200985	TR 2SC2603 F,G
6-TR5to28	ET-554657	TR 2SA733A P,Q
6-D1	ED-318292	D SILICON H 1S2473T-77 T26
6-D2to4	ED-308952	D GERMA V 1K34A-LR F07
6-D5to10	ED-318292	D SILICON H 1S2473T-77 T26
6-X1	EI-318384	OSC X'TAL NC-18C 3.579545MHZ

SP (Service Parts) Classification
 This reference numbers corresponds with symbol numbers of Schematic Diagrams.

5. Both the kind of part and installation position can be determined by the Parts Number. To determine where a parts number is listed, utilize Parts Index at end of Parts List. It is necessary first of all to find the Parts Number. This can be accomplished by using the Reference Number listed at right of parts number in the Parts Index.

WARNING

△ INDICATES SAFETY CRITICAL COMPONENTS FOR CONTINUED SAFETY, REPLACE SAFETY CRITICAL COMPONENTS ONLY WITH MANUFACTURE'S RECOMMENDED PARTS

AVERTISSEMENT

△ IL INDIQUE LES COMPOSANTS CRITIQUES DE SÉCURITÉ. POUR MAINTENIR LE DEGRÉ DE SÉCURITÉ DE L'APPAREIL, NE REMPLACER QUE DES PIÈCES RECOMMANDÉES PAR LE FABRICANT

RECOMMENDED SPARE PARTS

Because, if the parts listed below are on hand, almost any repair can be accomplished, we suggest that you stock these Recommended Spare Parts Items.

REF. NO.	PARTS NO.	DESCRIPTION
1	BT-780170	△ TRANS POWER CS4-9529 (J)
2	BT-780171	△ TRANS POWER CS4-9530 (C,A)
3	BT-780172	△ TRANS POWER CS4-9599 (E,V)
4	BT-780173	△ TRANS POWER CS4-9600 (B,S)
5	BT-780174	△ TRANS POWER CS4-9601 (U)
6	EI-780148	OSC CE KBR400B
7	ED-712568	D SILICON H DSF10B
8	ED-344280	D SILICON H GMA-01-FY2 F05
9	ED-780157	D ZENER GZA 51X
10	ED-780154	D ZENER GZA 6.2Z
11	ED-780155	D ZENER GZA 6.8X
12	ED-712928	D ZENER GZA5.6 X
13	ED-780156	D ZENER GZA9.1Y
14	ED-708061	D ZENER H GZA16 Z
15 N	EF-322975	△ FUSE EAWK T 250V 0.16A (U,E,V,B,S)
16 N	EF-300588	△ FUSE EAWK T 250V 0.20A (J)
17 N	EF-300586	△ FUSE EAWK T 250V 0.25A (U,E,V,B,S)
18	EF-780159	△ FUSE TIME 250V 0.063A (U,E,V,B,S)
19	EF-487427	△ FUSE ULCS-61M A 250V 0.20A (C,A)
20	EI-780147	IC LA6324
21	EI-336761	IC LA6458S
22	EI-349874	IC LB1245
23	EI-345765	IC LB1292
24	EI-343417	IC LB1294
25	EI-349871	IC LC6502C-658
26	EI-349870	IC LC6505C-650
27	EI-349873	IC LM6405H-360
28	EI-349872	IC LM6405H-361
29	EI-780152	IC MC14016B
30	EI-712581	IC TC9170P
31	EI-780150	OSC CE CSA1.000MK
32	EI-780149	OSC CE KBR800H
33	EM-349875	IND FL BG-205ZK
34	EQ-712575	RELAY POWER G5A237P
35	ES-348998	△ SW PUSH SDL1P 01-1
36	ES-780175	△ SW SELECTOR HXW-0103-01-430 (U) (S101)
37	ES-336780	SW TACT KHH10902
38	ET-322598	TR 2SB632K E,F
39	ET-223446	TR 2SC1571NP G,H
40	ET-403413	TR 2SC536NP H
41	ET-780153	TR 2SD1153
42	ET-321596	TR 2SD600K F
43	ET-350948	TR 2SD612K F

"NOTE" N: New Parts

SYMBOL FOR DESTINATION

- A: AAL (U.S.A.)
- B: UK (England)
- C: CSA (Canada)
- E: CEE (Europe)
- J: JPN (Japan)
- S: SAA (Australia)
- U: U/T (Universal Area)
- V: VDE (West Germany)

1. MAIN PC BOARD BLOCK

REF. NO.	PARTS NO.	DESCRIPTION
1-1U	BA-780193	PC MAIN BLK EA-A7 (U,E,V,B,S)
1-1J	BA-780192	PC MAIN BLK EA-A7 (J,C,A)
MAIN PC BOARD		
1-IC101		
to 103	EI-780152	IC MC14016B
1-IC104	EI-336761	IC LA6458S
1-IC106		
to 112	EI-712581	IC TC9170P
1-IC113		
to 118	EI-336761	IC LA6458S
1-IC201		
to 203	EI-780152	IC MC14016B
1-IC204	EI-336761	IC LA6458S
1-IC214		
to 218	EI-336761	IC LA6458S
1-Q104		
to 110	ET-223446	TR 2SC1571NP G,H
1-Q111,		
112	ET-350948	TR 2SD612K F
1-Q113	ET-322598	TR 2SB632K E,F
1-Q114	ET-321596	TR 2SD600K F
1-Q115	ET-780153	TR 2SD1153
1-Q204		
to 210	ET-223446	TR 2SC1571NP G,H
1-D101		
to 110	ED-344280	D SILICON H GMA-01-FY2 F05
1-D111	ED-780154	△ D ZENER GZA 6.2Z
1-D112	ED-712928	D ZENER GZA5.6 X
1-D113		
to 117	ED-712568	D SILICON H DSF10B
1-D120	ED-712568	D SILICON H DSF10B
1-D121,		
122	ED-708061	△ D ZENER H GZA16 Z
1-D123		
to 126	ED-712568	D SILICON H DSF10B
1-D127	ED-780157	△ D ZENER GZA 51X
1-D128,		
129	ED-712568	D SILICON H DSF10B
1-D130	ED-780155	D ZENER GZA 6.8X
1-D140,		
141	ED-780156	D ZENER GZA9.1Y
1-D201		
to 210	ED-344280	D SILICON H GMA-01-FY2 F05
1-RL1,2	EQ-712575	RELAY POWER G5A237P
1-R191,		
192	ER-304175	△ R OMF H FS 2W 151J
1-R193,		
194	ER-306879	R CB H S15 FS RDS 1/2W 221J
1-R197,		
198	ER-306127	△ R CB H S15 FS RDS 1/2W 681J
1-R199	ER-780158	△ R OMF H FS 2W 242J
1-R291	ER-308503	△ R OMF H FS 1W 181J
1-R295,		
296	ER-306879	R CB H S15 FS RDS 1/2W 221J
1-C195,		
196	EC-700458	C CE 472J 500V
1-F101,		
102	EF-322975	△ FUSE EAWK T 250V 0.16A (U,E,V,B,S)
1-F103,		
104	EF-300586	△ FUSE EAWK T 250V 0.25A (U,E,V,B,S)
1-F105,		
106	EF-780159	△ FUSE TIME 250V 0.063A (U,E,V,B,S)
1-2	EJ-709341	PIN J AJC-035-AAB 4P (TAPE 1, TAPE 2, AUX)

2. MICOM PC BOARD BLOCK

REF. NO.	PARTS NO.	DESCRIPTION
2-1U	BA-780195	PC MICOM BLK EA-A7 (U)
2-1J	BA-780194	PC MICOM BLK EA-A7 (J)
2-1C	BA-713034	PC MICOM BLK EA-A7 (C,A)
2-1E	BA-780196	PC MICOM BLK EA-A7 (E,V,B,S)

CPU PC BOARD

2-IC301, 302	EI-343417	IC LB1294
2-IC303	EI-349870	IC LC6505C-650
2-IC304	EI-349871	IC LC6502C-658
2-IC305	EI-349873	IC LM6405H-360
2-IC306, 307	EI-349872	IC LM6405H-361
2-IC308 to 311	EI-780147	IC LA6324
2-IC312	EI-345765	IC LB1292
2-IC313 to 316	EI-349874	IC LB1245
2-Q302, 303	ET-403413	TR 2SC536NP H
2-D301, 302	ED-344280	D SILICON H GMA-01-FY2 F05
2-D310	ED-344280	D SILICON H GMA-01-FY2 F05
2-D332	ED-344280	D SILICON H GMA-01-FY2 F05
2-D333	ED-344280	△ D SILICON H GMA-01-FY2 F05
2-D334	ED-344280	D SILICON H GMA-01-FY2 F05
2-D335	ED-344280	△ D SILICON H GMA-01-FY2 F05
2-D336	ED-712568	D SILICON H DSF10B
2-X1	EI-780148	OSC CE KBR400B
*2-X2	EI-780149	OSC CE KBR800H (OLD)
*2-X2	EI-780150	OSC CE CSA1.000MK (NEW)
2-C317	EC-713033	C DOUBLE LAYER 474Z 5.5VDC

POWER SW PC BOARD

2-S45	ES-348998	△ SW PUSH SDL1P 01-1 (POWER SW)
2-F107	EF-322975	△ FUSE EAWK T 250V 0.16A (U)
2-F107	EF-300588	△ FUSE EAWK T 250V 0.20A (J)
2-F107	EF-487427	△ FUSE ULCS-61M A 250V 0.20A (C,A)
2-C326J	EC-780151	△ C MY V ECQUH 103M 125AC (J,A,C)
2-C326U	EC-330308	△ C MMY V ECQUF 103M 250AC (U,E,V,B,S)

FLD PC BOARD

2-D313	ED-344280	D SILICON H GMA-01-FY2 F05
2-D315 to 317	ED-344280	D SILICON H GMA-01-FY2 F05
2-S14	ES-336780	SW TACT KHH10902
2-S24	ES-336780	SW TACT KHH10902
2-S26 to 28	ES-336780	SW TACT KHH10902
2-IND1	EM-349875	IND FL BG-205ZK

SW PC BOARD

2-D303	ED-344280	D SILICON H GMA-01-FY2 F05
2-D311, 312	ED-344280	D SILICON H GMA-01-FY2 F05
2-D314	ED-344280	D SILICON H GMA-01-FY2 F05
2-D318 to 331	ED-344280	D SILICON H GMA-01-FY2 F05
2-S15	ES-336780	SW TACT KHH10902
2-S22,23	ES-336780	SW TACT KHH10902
2-S25	ES-336780	SW TACT KHH10902
2-S29 to 44	ES-336780	SW TACT KHH10902

SELECT SW PC BOARD

2-D304 to 309	ED-344280	D SILICON H GMA-01-FY2 F05
2-S16 to 21	ES-336780	SW TACT KHH10902

"NOTE 2-X2: Due to the change, J model after SERIAL No 90410-03301 are employed new parts. And also OTHERS models after SERIAL No 90580-00101 are employed new parts.

ASSEMBLY BLOCK

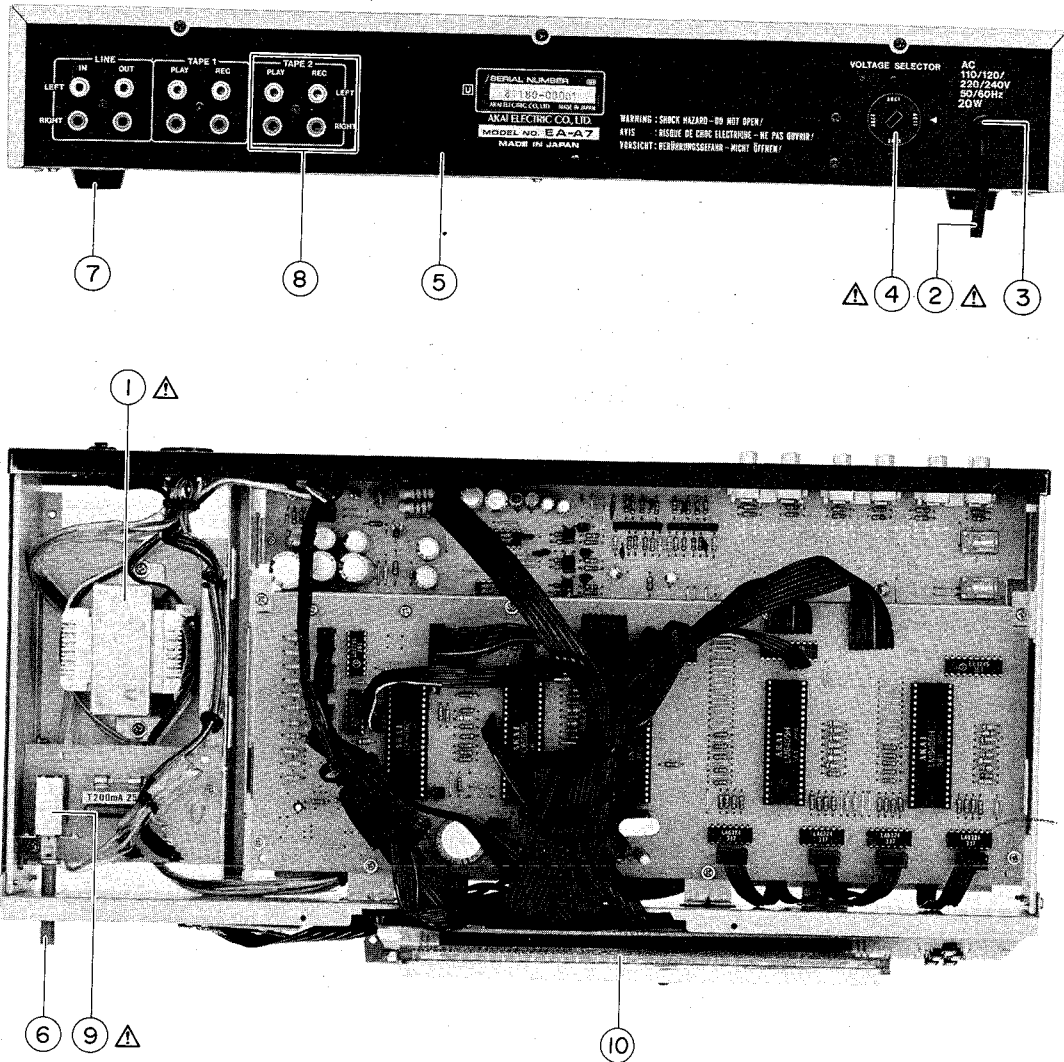

3. ASSEMBLY BLOCK

REF. NO.	PARTS NO.	DESCRIPTION	REF. NO.	PARTS NO.	DESCRIPTION
3-1U	BT-780174	△ TRANS POWER CS4-9601 (U) (U)	3-2B	EW-313884	△ AC CORD 2 CORES GTBS-2F
3-1J	BT-780170	△ TRANS POWER CS4-9529 (J) (J)			24/0.20x2 B (B) (S,P)
3-1C	BT-780171	△ TRANS POWER CS4-9530 (C,A) (C,A)	3-2BB	EW-780177	△ AC CORD 2 CORES GTBS-2F
3-1E	BT-780172	△ TRANS POWER CS4-9599 (E,V) (E,V)			BLACK (B) (BL)
3-1B	BT-780173	△ TRANS POWER CS4-9600 (B,S) (B,S)	3-2S	EW-336924	△ AC CORD 2 CORES KP-560,
3-2U	EW-780176	△ AC CORD 2CORES KP-700 GRAY VFF U/T (U) (S,P)	3-2SB	EW-780178	△ AC CORD 2 CORES KP-560
3-2UB	EW-306428	△ AC CORD 2 CORES KP-700A, (U) (BL)			BLACK (S) (BL)
3-2J	EW-306427	△ AC CORD 2 CORES KP-211, VFF J (J) (S)	3-3U	EZ-631945	STRAIN RELIEF SR-4N-4 (U,J,C,A)
3-2JB	EW-351961	△ AC CORD 2 CORES KP-211 VFF J (J) (BL)	3-3E	EJ-692908	STRAIN RELIEF SR-5N-4 (E,V,B,S)
3-2C	EW-780179	△ AC CORD 2 CORES KP-10 BROWN (C,A) (S,P)	3-4	ES-780175	△ SW SELECTOR HXW-0103-01-430 (U) (S101)
3-2CB	EW-348215	△ AC CORD 2 CORES KP10,SPT1 105CCB UC (C,A) (BL)	3-5U	SP-780161	PANEL REAR EA-A7 (U) (U)
3-2E	EW-336923	△ AC CORD 2 CORES KP-419C, LTCE-2F EV (E,V) (S,P)	3-5J	SP-780160	PANEL REAR EA-A7 (J) (J)
3-2EB	EW-338516	△ AC CORD KP-419C,LTCE-2F E (E,V) (BL)	3-5C	SP-780163	PANEL REAR EA-A7 (C,A) (C,A)
			3-5E	SP-780162	PANEL REAR EA-A7 (E,V) (E,V)
			3-5B	SP-780164	PANEL REAR EA-A7 (B,S) (B,S)
			3-6	MZ-780167	JOINT POWER
			3-7	SA-710514	RUBBER FOOT EA-M7
			3-8	EJ-709341	PIN J AJC-035-AAB 4P
					MICOM PC BOARD BLOCK
			3-9	ES-348998	△ SW PUSH SDL1P 01-1 (S45)
			3-10	EM-349875	IND FL BG-205ZK

FINAL ASSEMBLY BLOCK

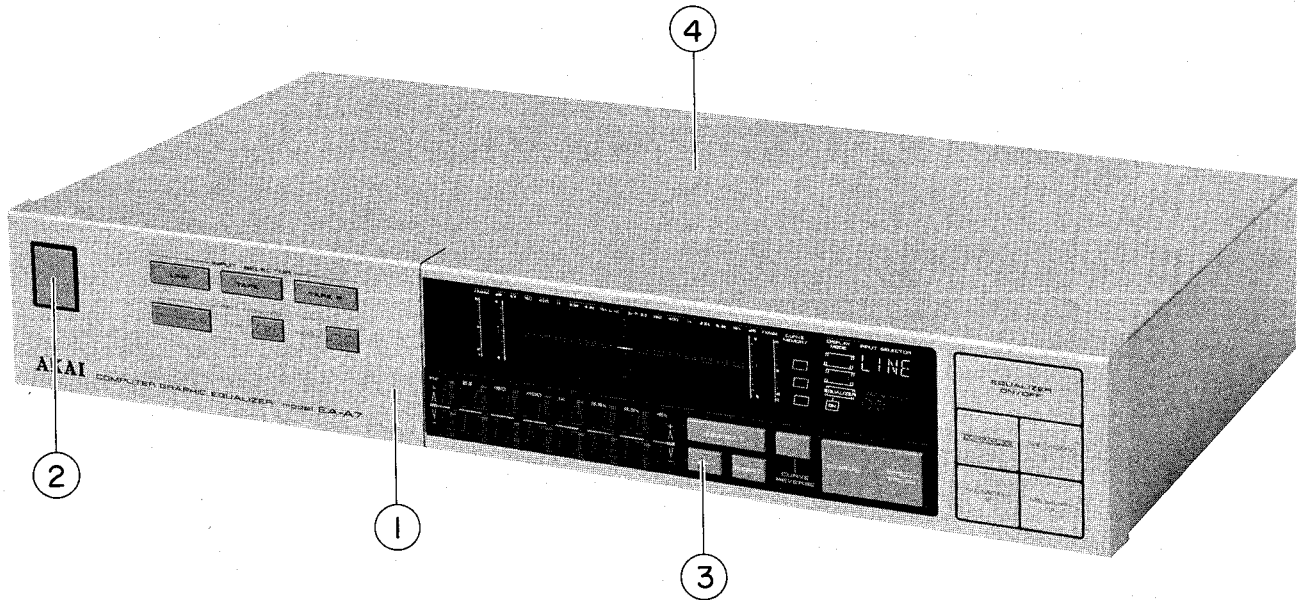

4. FINAL ASSEMBLY BLOCK

REF. NO.	PARTS NO.	DESCRIPTION
4-1S	BD-780180	PANEL FRONT-S PART
4-1P	BD-780181	PANEL FRONT-P PART (EXCEPT J)
4-1B	BD-780182	PANEL FRONT-B PART
4-2S	SK-343017C	KNOB POWER (2)
4-2P	SK-343017B	KNOB POWER-P (EXCEPT J)
4-2B	SK-343017F	KNOB POWER-B
4-3S	SK-780186	KNOB RUBBER-S
4-3P	SK-780187	KNOB RUBBER-P (EXCEPT J)
4-3B	SK-780188	KNOB RUBBER-B
4-4S	SP-780189	COVER UPPER-S
4-4P	SP-780190	COVER UPPER-P (EXCEPT J)
4-4B	SP-780191	COVER UPPER-B

SYMBOL FOR COLOR VARIATION

S: SILVER
P: PEARL SHADOW
B or BL: BLACK

INDEX

PARTS NO.	REF. NO.	PARTS NO.	REF. NO.	PARTS NO.	REF. NO.	PARTS NO.	REF. NO.	PARTS NO.	REF. NO.
BA-713034	2-1C	ED-712568	1-D124	ER-306879	1-R194	SK-780187	4-3P		
BA-780192	1-1J	ED-712568	1-D116	ER-306879	1-R296	SK-780188	4-3B		
BA-780193	1-1U	ED-712568	1-D123	ER-306879	1-R193	SP-780160	3-5J		
BA-780194	2-1J	ED-712568	1-D117	ER-306879	1-R295	SP-780161	3-5U		
BA-780195	2-1U	ED-712568	1-D115	ER-308503	1-R291	SP-780162	3-5E		
BA-780196	2-1E	ED-712568	1-D120	ER-780158	1-R199	SP-780163	3-5C		
BD-780180	4-1S	ED-712568	1-D126	ES-336780	2-S44	SP-780164	3-5B		
BD-780181	4-1P	ED-712568	1-D114	ES-336780	2-S43	SP-780189	4-4S		
BD-780182	4-1B	ED-712568	1-D113	ES-336780	2-S39	SP-780190	4-4P		
BT-780170	3-1J	ED-712568	2-D336	ES-336780	2-S42	SP-780191	4-4B		
BT-780171	3-1C	ED-712928	1-D112	ES-336780	2-S36				
BT-780172	3-1E	ED-780154	1-D111	ES-336780	2-S20				
BT-780173	3-1B	ED-780155	1-D130	ES-336780	2-S25				
BT-780174	3-1U	ED-780156	1-D140	ES-336780	2-S37				
EC-330308	2-C326U	ED-780156	1-D141	ES-336780	2-S26				
EC-700458	1-C196	ED-780157	1-D127	ES-336780	2-S17				
EC-700458	1-C195	EF-300586	1-F104	ES-336780	2-S15				
EC-713033	2-C317	EF-300586	1-F103	ES-336780	2-S32				
EI-780148	2-X1	EF-300588	2-F107	ES-336780	2-S28				
EC-780151	2-C326J	EF-322975	1-F102	ES-336780	2-S24				
ED-344280	1-D204	EF-322975	1-F101	ES-336780	2-S18				
ED-344280	1-D104	EF-322975	2-F107	ES-336780	2-S27				
ED-344280	1-D109	EF-487427	2-F107	ES-336780	2-S38				
ED-344280	1-D108	EF-780159	1-F106	ES-336780	2-S41				
ED-344280	1-D106	EF-780159	1-F105	ES-336780	2-S31				
ED-344280	1-D101	EI-336761	1-IC116	ES-336780	2-S19				
ED-344280	1-D103	EI-336761	1-IC117	ES-336780	2-S40				
ED-344280	1-D210	EI-336761	1-IC118	ES-336780	2-S21				
ED-344280	1-D209	EI-336761	1-IC215	ES-336780	2-S33				
ED-344280	1-D205	EI-336761	1-IC114	ES-336780	2-S35				
ED-344280	1-D206	EI-336761	1-IC216	ES-336780	2-S30				
ED-344280	1-D110	EI-336761	1-IC214	ES-336780	2-S22				
ED-344280	1-D107	EI-336761	1-IC217	ES-336780	2-S16				
ED-344280	1-D105	EI-336761	1-IC113	ES-336780	2-S29				
ED-344280	1-D203	EI-336761	1-IC204	ES-336780	2-S23				
ED-344280	1-D102	EI-336761	1-IC115	ES-336780	2-S14				
ED-344280	1-D202	EI-336761	1-IC104	ES-336780	2-S34				
ED-344280	1-D207	EI-336761	1-IC218	ES-348998	2-S45				
ED-344280	1-D208	EI-343417	2-IC302	ES-348998	3-9				
ED-344280	1-D201	EI-343417	2-IC301	ES-780175	3-4				
ED-344280	2-D309	EI-345765	2-IC312	ET-223446	1-Q204				
ED-344280	2-D333	EI-349870	2-IC303	ET-223446	1-Q104				
ED-344280	2-D310	EI-349871	2-IC304	ET-223446	1-Q108				
ED-344280	2-D332	EI-349872	2-IC306	ET-223446	1-Q105				
ED-344280	2-D335	EI-349872	2-IC307	ET-223446	1-Q210				
ED-344280	2-D334	EI-349873	2-IC305	ET-223446	1-Q205				
ED-344280	2-D316	EI-349874	2-IC313	ET-223446	1-Q209				
ED-344280	2-D317	EI-349874	2-IC314	ET-223446	1-Q207				
ED-344280	2-D313	EI-349874	2-IC316	ET-223446	1-Q206				
ED-344280	2-D311	EI-349874	2-IC315	ET-223446	1-Q109				
ED-344280	2-D324	EI-712581	1-IC111	ET-223446	1-Q107				
ED-344280	2-D308	EI-712581	1-IC112	ET-223446	1-Q106				
ED-344280	2-D305	EI-712581	1-IC109	ET-223446	1-Q208				
ED-344280	2-D320	EI-712581	1-IC110	ET-223446	1-Q110				
ED-344280	2-D312	EI-712581	1-IC108	ET-321596	1-Q114				
ED-344280	2-D302	EI-712581	1-IC107	ET-322598	1-Q113				
ED-344280	2-D329	EI-712581	1-IC106	ET-350948	1-Q112				
ED-344280	2-D319	EI-780147	2-IC311	ET-350948	1-Q111				
ED-344280	2-D328	EI-780147	2-IC309	ET-403413	2-Q302				
ED-344280	2-D323	EI-780147	2-IC310	ET-403413	2-Q303				
ED-344280	2-D322	EI-780147	2-IC308	ET-780153	1-Q115				
ED-344280	2-D306	EI-780149	2-X2	EW-306427	3-2J				
ED-344280	2-D321	EI-780150	2-X2	EW-306428	3-2UB				
ED-344280	2-D327	EI-780152	1-IC101	EW-313884	3-2B				
ED-344280	2-D326	EI-780152	1-IC103	EW-336923	3-2E				
ED-344280	2-D325	EI-780152	1-IC102	EW-336924	3-2S				
ED-344280	2-D330	EI-780152	1-IC203	EW-338516	3-2EB				
ED-344280	2-D301	EI-780152	1-IC201	EW-348215	3-2CB				
ED-344280	2-D304	EI-780152	1-IC202	EW-351961	3-2JB				
ED-344280	2-D307	EJ-692908	3-3E	EW-780176	3-2U				
ED-344280	2-D331	EJ-709341	1-2	EW-780177	3-2BB				
ED-344280	2-D315	EJ-709341	3-8	EW-780178	3-2SB				
ED-344280	2-D318	EM-349875	2-IND1	EW-780179	3-2C				
ED-344280	2-D314	EM-349875	3-10	EZ-631945	3-3U				
ED-344280	2-D303	EQ-712575	1-RL2	MZ-780167	3-6				
ED-708061	1-D122	EQ-712575	1-RL1	SA-710514	3-7				
ED-708061	1-D121	ER-304175	1-R191	SK-343017C	4-2S				
ED-712568	1-D125	ER-304175	1-R192	SK-343017B	4-2P				
ED-712568	1-D129	ER-306127	1-R197	SK-343017F	4-2B				
ED-712568	1-D128	ER-306127	1-R198	SK-780186	4-3S				

AKAI

MODEL EA-A7

**PC BOARD
SCHEMATIC DIAGRAM**

EA-A7

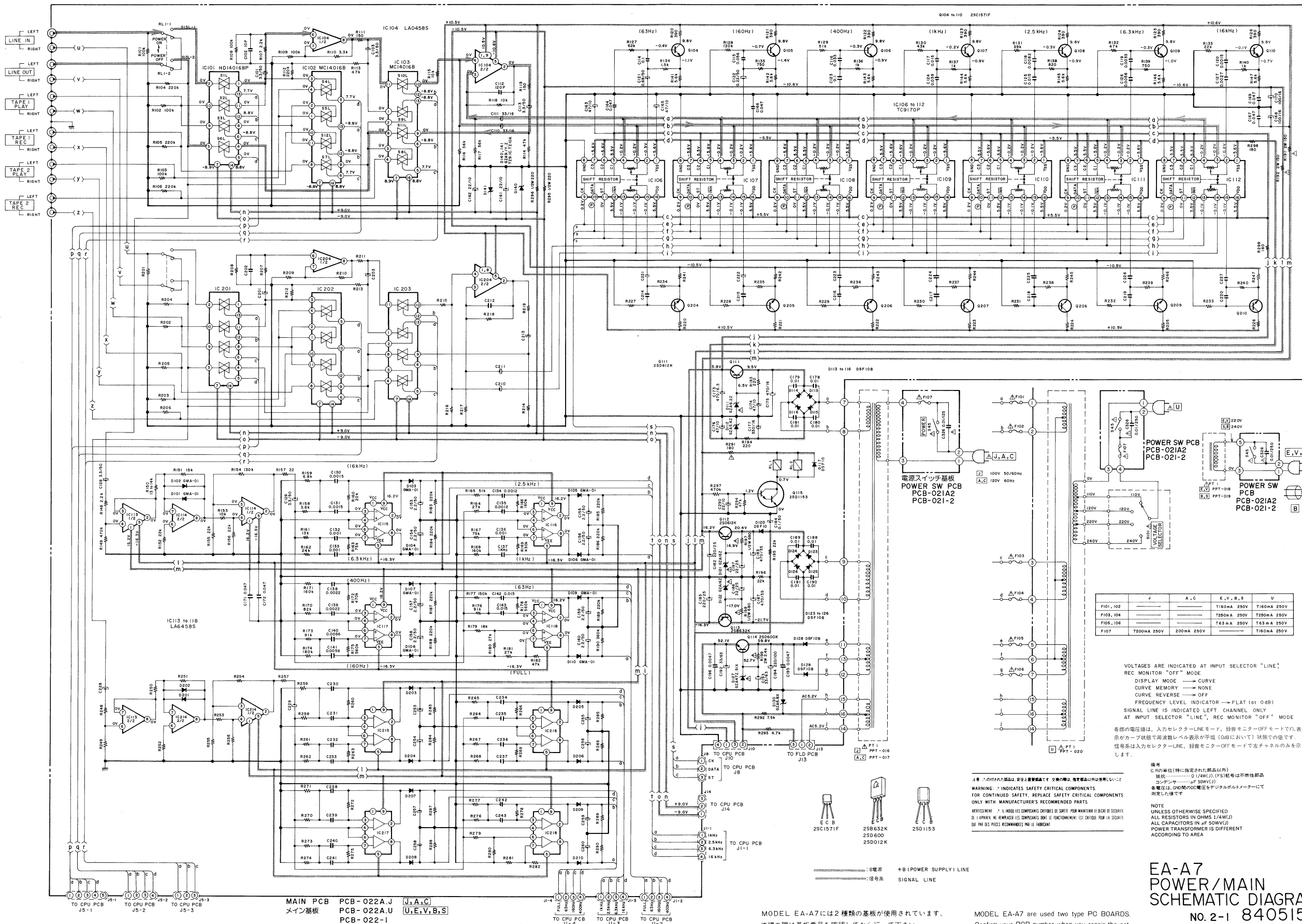

	J	A, C	E, V, B, S	U
F101, 102			T160mA 250V	T160mA 250V
F103, 104			T250mA 250V	T250mA 250V
F105, 106			T63mA 250V	T63mA 250V
F107	T200mA 250V	200mA 250V		T160mA 250V

VOLTAGES ARE INDICATED AT INPUT SELECTOR "LINE",
REC MONITOR "OFF" MODE
DISPLAY MODE → CURVE
CURVE MEMORY → NONE
CURVE REVERSE → OFF
FREQUENCY LEVEL INDICATOR → FLAT (0dB)
SIGNAL LINE IS INDICATED LEFT CHANNEL ONLY
AT INPUT SELECTOR "LINE", REC MONITOR "OFF" MODE

各部の電圧値は、入力セクター-LINEモード、録音モニター-OFFモードでFL表示
がカーブ状態で周波数レベル表示が平坦(0dBにおいて)状態での値です。
信号系は入力セクター-LINE、録音モニター-OFFモードで左チャンネルのみを示
します。

備考
Cの単位(特に指定された部品以外)
抵抗値……………Ω(1kΩ), (PS)記号は不燃性部品
コンデンサ……………μF(50V(J))
※電圧は、GND間の電圧をデジタルポルトメーターにて
測定した値です

NOTE
UNLESS OTHERWISE SPECIFIED
ALL RESISTORS IN OHMS (1/4W(J))
ALL CAPACITORS IN μF (50V(J))
POWER TRANSFORMER IS DIFFERENT
ACCORDING TO AREA

警告
*の付いた部品は、安全上重要部品で、交換の際は、指定部品は使用しないこと
FOR CONTINUED SAFETY, REPLACE SAFETY CRITICAL COMPONENTS
ONLY WITH MANUFACTURER'S RECOMMENDED PARTS
REMARKS
* IN MODEL'S COMPONENT LISTINGS IS SPECIFIED FOR MAINTENANCE USE ONLY IN SECONDARY
OR REPAIR USE. REMARKS ARE COMPONENTS WHICH ARE NOT RECOMMENDED FOR USE IN SECONDARY
OR REPAIR USE. RECOMMENDED PARTS ARE INDICATED.

●電源
●+B (POWER SUPPLY) LINE
●信号系
●SIGNAL LINE

EA-A7
POWER/MAIN
SCHEMATIC DIAGRAM
NO. 2-1 840515A

MODEL EA-A7には2種類の基板が使用されています。
修理の際は基板番号を確認してから行って下さい

MODEL EA-A7 are used two type PC BOARDS.
Confirm your PCB number when you repair the set.

注意: △の付された部品は、安全上重要部品です。交換の際は、指定部品以外は使用しないこと。

WARNING: △ INDICATES SAFETY CRITICAL COMPONENTS. FOR CONTINUED SAFETY, REPLACE SAFETY CRITICAL COMPONENTS ONLY WITH MANUFACTURER'S RECOMMENDED PARTS.

AVERTISSEMENT: △ IL INDIQUE LES COMPOSANTS CRITIQUES DE SURETE. POUR MAINTENIR LE DEGRE DE SECURITE DE L'APPAREIL, NE REMPLACER LES COMPOSANTS DONT LE FONCTIONNEMENT EST CRITIQUE POUR LA SECURITE QUE PAR DES PIECES RECOMMANDEES PAR LE FABRICANT.

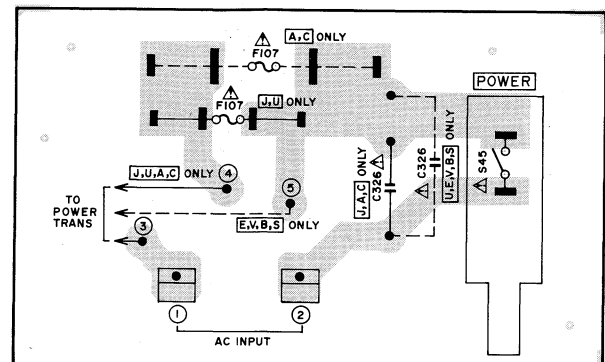

- Q104 to I10, 204 to 210 ---- 2SC1571
- Q111, I12 ---- 2SD612K
- Q113 ---- 2SD632K
- Q114 ---- 2SD600K
- Q115 ---- 2SD1153

MAIN PCB PCB-022AJ J,A,C
メイン基板 PCB-022AU U,E,V,B,S

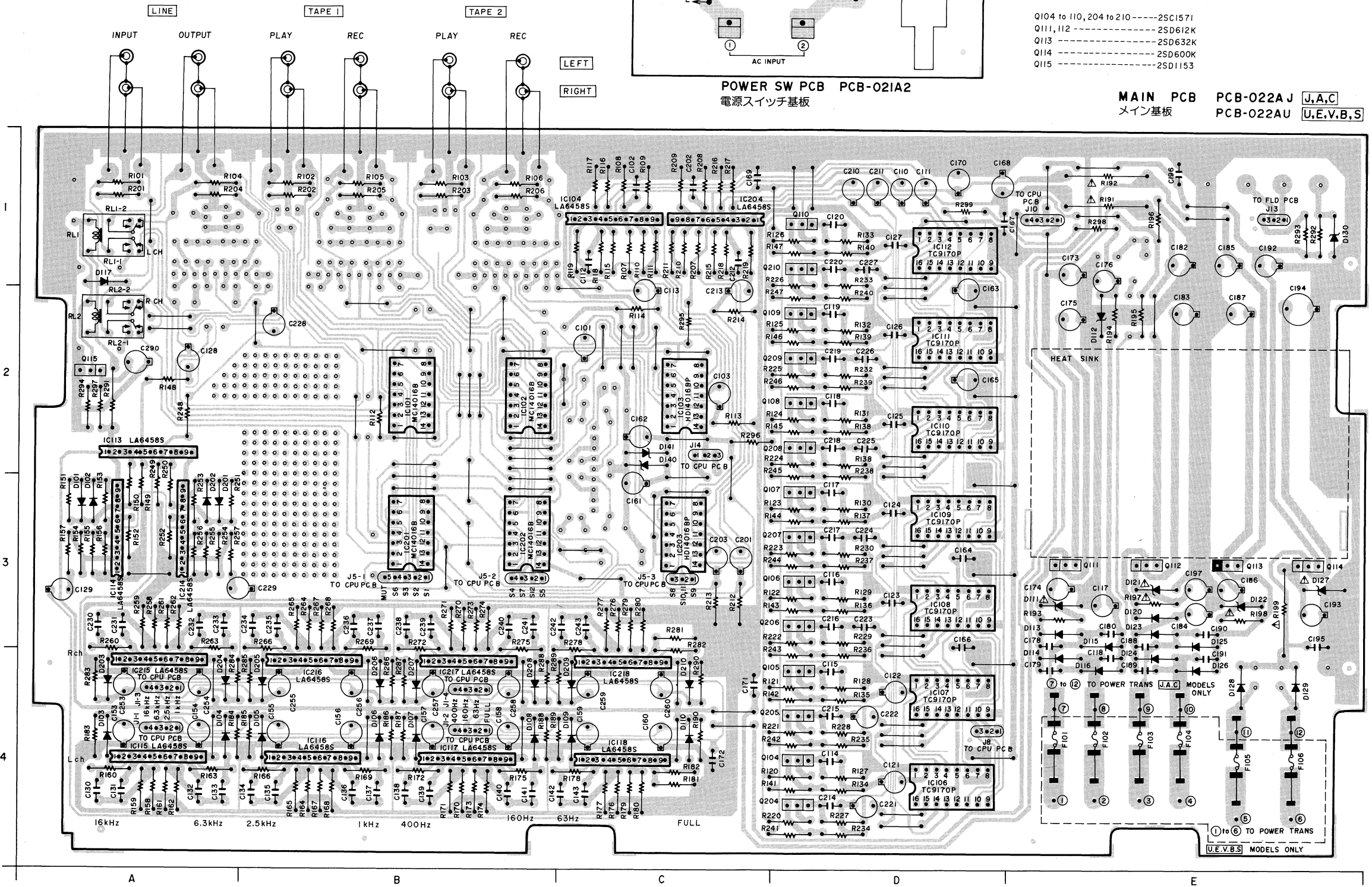

- LOCATION OF COMPONENTS
- IC'S
- IC101, 102 ---- B2
 - IC103 ---- C2
 - IC104, 204 ---- C1
 - IC106, 107 ---- D4
 - IC108, 109 ---- D3
 - IC110, 111 ---- D2
 - IC112 ---- D1
 - IC113 ---- A2
 - IC114, 214 ---- A3
 - IC115, 215 ---- A4
 - IC116, 117, 216, 217 ---- B4
 - IC118, 218 ---- C4
 - IC201, 202 ---- B3
 - IC203 ---- C3

- TRANSISTORS
- Q104, 105, 204, 205 ---- D4
 - Q106, 107, 206, 207 ---- D3
 - Q108, 109, 208, 209 ---- D2
 - Q110, 210 ---- D1
 - Q111 to 114 ---- E3
 - Q115 ---- A2

- TERMINAL
- J1-1, 1-3 ---- A4
 - J1-2, 1-4 ---- B4
 - J5-1, 5-2 ---- B3
 - J5-3 ---- C3
 - J8 ---- D4
 - J10, 13 ---- E1
 - J14 ---- D2
 - ① to ② ---- E4

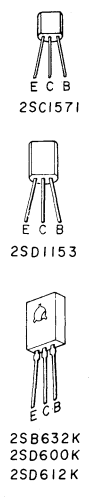

MODEL EA-A7には2種類の基板が使用されています。
修理の際は基板番号を確認してから行って下さい。

MODEL EA-A7 are used two type PC BOARDS.
Confirm your PCB number when you repair the set.

EA - A7

IC101 : MC14016B
IC102,103 : HD14016BP

IC106 to IC112 ELECTRONIC VARIABLE RESISTOR

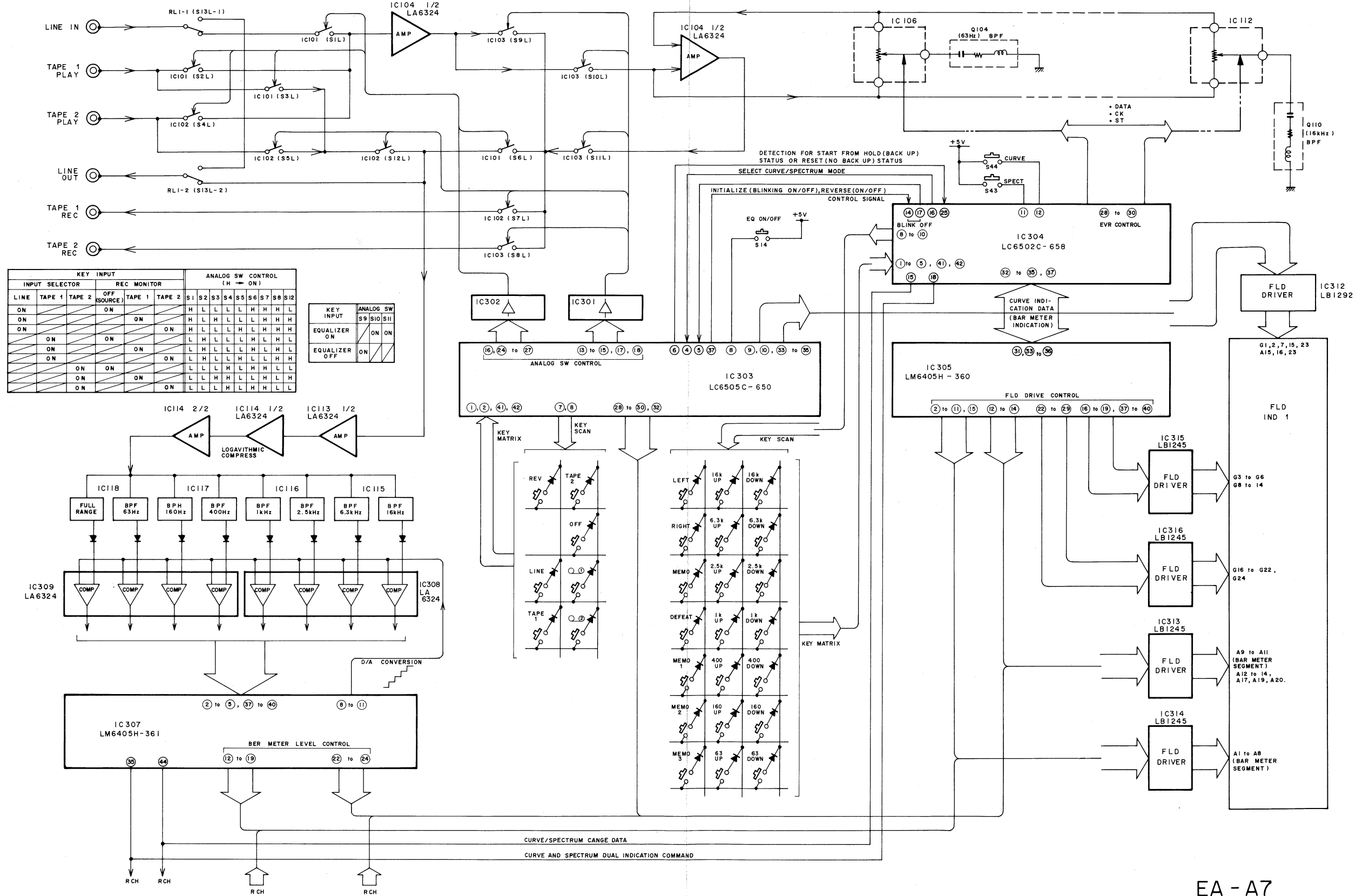

KEY INPUT				ANALOG SW CONTROL (H → ON)								
LINE	TAPE 1	TAPE 2	REC MONITOR	S1	S2	S3	S4	S5	S6	S7	S8	S12
ON			ON	H	L	L	L	L	H	H	H	L
ON			ON	H	L	L	L	L	H	H	H	H
ON			ON	L	H	L	L	L	H	L	H	L
ON	ON		ON	L	H	L	L	L	H	L	H	L
ON	ON	ON	ON	L	L	L	L	L	H	L	H	L
ON	ON	ON	ON	L	L	L	L	L	H	L	H	L
ON	ON	ON	ON	L	L	L	L	L	H	L	H	L
ON	ON	ON	ON	L	L	L	L	L	H	L	H	L

KEY INPUT	ANALOG SW
EQUALIZER ON	ON ON
EQUALIZER OFF	ON

EA - A7
BLOCK DIAGRAM
NO. 840514A(A2)