

DENON

Hi Fi Component/Record Player

SERVICE MANUAL

SERVO-CONTROLLED
DIRECT DRIVE RECORD PLAYER

MODEL DP-59L



NIPPON COLUMBIA CO., LTD.

TABLE OF CONTENTS

| | |
|---|-------|
| FEATURES | 2 |
| MAIN SPECIFICATIONS | 3 |
| BLOCK DIAGRAM | 4 |
| NAMES OF PARTS AND FUNCTION | 5 |
| EXPLANATION OF THE MICROPROCESSOR | 6~ 7 |
| TERMINAL FUNCTION EXPLANATION OF LF3735 | |
| PLL SPEED CONTROL | 8~ 9 |
| ADJUSTMENT METHOD | 10~11 |
| PARTS LIST OF EXPLODED VIEW | 12 |
| EXPLODED VIEW | 13 |
| SCHEMATIC DIAGRAM | 14 |
| P.W. BOARD OF MOTOR SERVO UNIT | 15 |
| P.W. BOARD OF POWER SUPPLY UNIT AND PARTS | |
| LIST OF P.W. BOARD | 16 |
| PARTS LIST OF P.W. BOARD | 17 |

FEATURES

1. Electronic Q-damping (Dynamic Servo Tracer)

Low frequency resonance, dependent upon cartridge compliance and the effective mass of the tonearm, is electronically damped both horizontally and vertically to eliminate crosstalk and inter-modulation distortion. This optimizes the performance of the DP-59L's arm and results in record reproduction with outstanding stereo imaging characteristics and a minimum of noise or vibration.

2. Low-mass straight arm tube with lamination damped headshell

Dual construction of the arm tube greatly reduces headshell resonance. This, together with the lowmass straight arm tube improves tracing ability and further contributes to the DP-59L's clarity and stable stereo imaging.

3. Thick precision turntable platter exhibits superb acoustic characteristics

The use of a thick turntable platter to minimize vibrations transmitted from external sources is essential for clear sound reproduction.

4. Quartz-lock speed control

The system uses phase-locked loop speed control (PLL method) to increase/decrease the turntable speed precisely (within $\pm 9.9\%$).

5. Excellent rotational characteristics

The DP-59L's high performance AC servo motor; magnetic record head speed detection system; quartz lock, bi-directional servo result in phenomenal performance specifications: 0.006% wrms (rotation system) wow and flutter; 82 dB (DIN-B) S/N ratio and rotational accuracy of 0.002%.

6. Auto-lift mechanism with non-contact end-of-record detection system

When the record is finished, the stylus automatically lifts off the record and the turntable stops rotation. This avoids unnecessary wear of the stylus tip.

7. Beautifully finished wood cabinet

The cabinet has a mirror-finish surface, measures 110 mm in height, and uses a new insulator to prevent howling.

8. Interchangeable straight and S-shape arm tubes via standard 4P connectors

Optimum cartridge matching can be achieved quickly and easily through interchangeable tonearm tubes.

Note:

The S-shape arm tube and headshell are sold separately from the system.

MAIN SPECIFICATIONS

Turntable motor

| | |
|------------------------------|---|
| Drive method: | Servo controlled direct drive |
| Speeds: | 33-1/3rpm, 45 rpm |
| Wow and flutter: | less than 0.006% wrms (servo system) less than 0.02% wrms (JIS) |
| S/N ratio: | more than 82dB (DIN-B) |
| Rise time: | Nominal speed within 1.6 seconds (at 33-1/3rpm) |
| Turntable platter: | Aluminum die-cast, 325mm diameter Moment of inertia 430kg · cm ² (incl. turntable sheet) |
| Motor type: | AC servo motor |
| Speed control method: | Speed servo via frequency detection and phase servo control |
| Load characteristics: | 0% (stylus force 200g, outermost groove) |
| Brake method: | Electronic brake |
| Speed deviation: | less than 0.002% |

Tonearm

| | |
|---|--|
| Type: | Static balance type tonearm with electronic damping mechanism (interchangeable tube section) |
| Effective length: | 244mm |
| Overhang: | 14mm |
| Tracking error: | within 2.5° |
| Stylus force range: | 0 – 3g (1g per 1 rotation, 1 scale = 0.1g) |
| Suitable cartridge weight range: | approx. 3~14g (using the straight type arm tube, incl. screws, nuts) |
| Arm height adjustment range: | approx. 7mm |
| Output cable: | Low capacitance type |
| Arm lifter: | Servo control via the angular control motor (Cueing device) |

General

| | |
|---------------------------|--|
| Power supply: | 50Hz/60Hz compatible. The rated voltage is indicated on the rating label at the rear of cabinet. |
| Power consumption: | 10W |
| Dimensions: | 490 x 219 x 410mm (W x H x D) 19.3 x 8.6 x 16.1 in (dust cover closed) |
| Weight: | 15 kg 33 lb |

* For product improvement purposes, the above specifications are subject to change without notice.

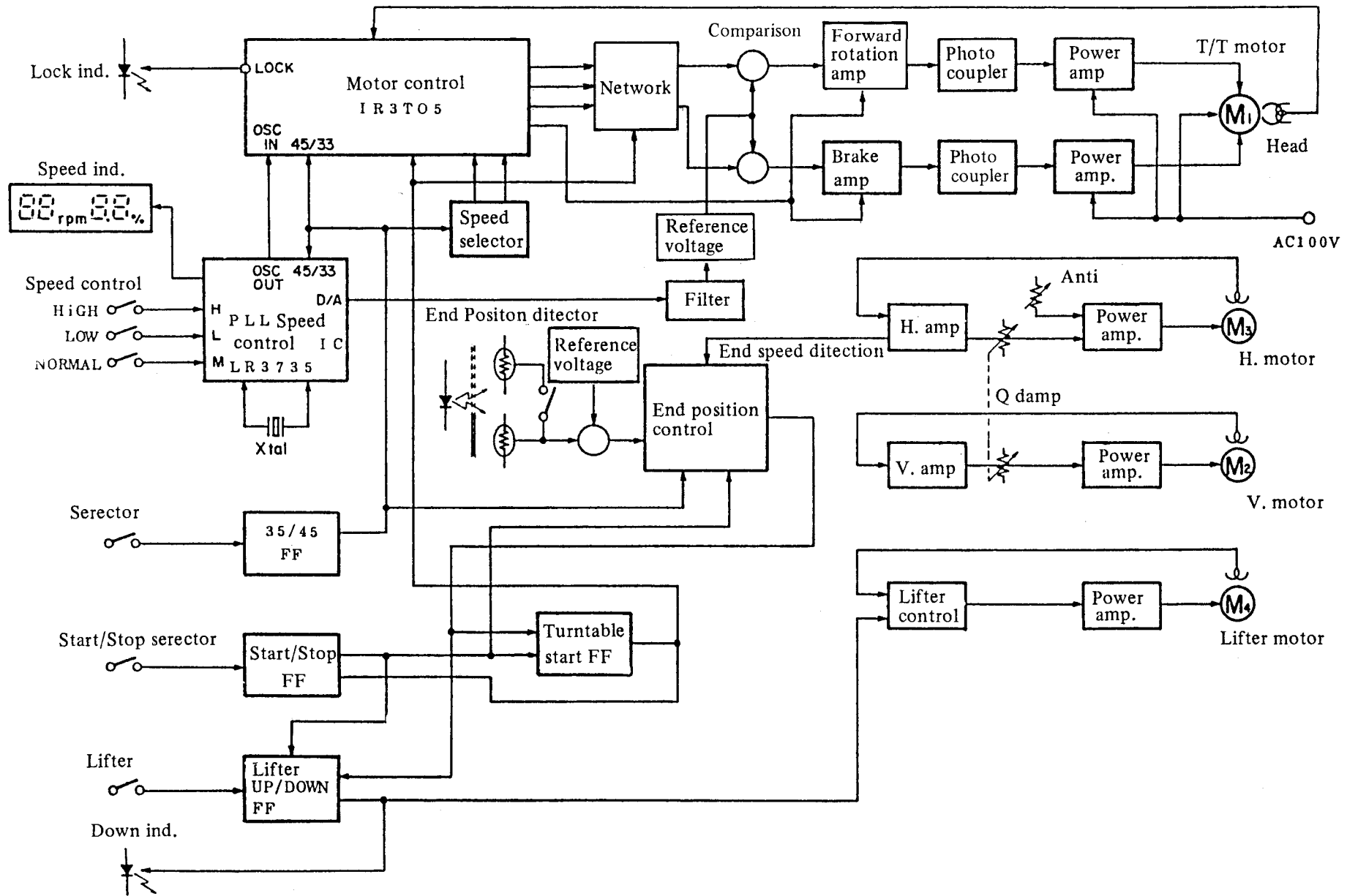

BLOCK DIAGRAM

NAMES OF PARTS AND FUNCTION

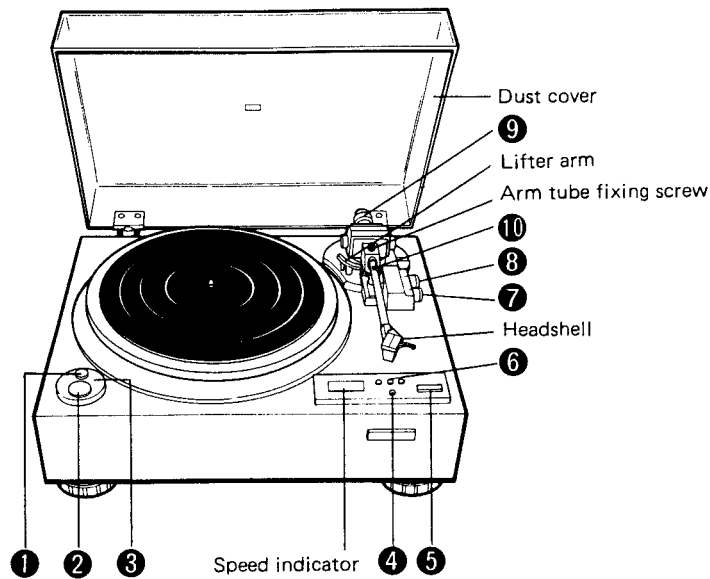

① Power switch POWER

Press the power switch (⏻) to turn on the power supply, and the "LOCK" LED and "33 rpm 0.0%" are displayed on the speed indicator. If the power switch (⏻) is pressed when the arm lift is in its lower most position, it will move up.

② Start/Stop button START/STOP

If the start/stop button is pressed when the turntable is at rest, it will rotate, the arm lift will move down and the "DOWN" LED lights up. Pressing the button while the turntable is rotating causes the arm lift to move up and the "DOWN" LED goes off. The turntable stops when the arm lift reaches its uppermost position.

③ Lock indicator LOCK

The lock indicator will light when the turntable speed reaches the specified phase-lock state. It flickers when the turntable speed is in transition, such as when stopping, starting or changing speeds. It remains off during stop.

④ Speed button SPEED 33/45

When the power switch (⏻) goes on, it automatically sets the turntable speed to 33-1/3 rpm. Press the speed button once to change the speed to 45 rpm, and once again to reset it to 33-1/3. Speed selection can be repeated this way.

⑤ Arm Lifter button LIFTER UP/DOWN

Each time the button is pressed, the arm lifter moves up/down. The lamp will light when the lifter is down.

⑥ Pitch control button PITCH CONTROL

The turntable speed can be increased or decreased precisely by the quartz-lock system. The speed increases 0.1% every time the "HIGH" button is pressed, and automatically increases 0.4% per second if the button is kept pressed in. The speed can be increased up to a maximum of +9.9%, and it is displayed on the digital speed indicator. The "LOW" button decreases the speed up to (9.9% max.) in a similar way to the "HIGH" button.

Pressing the "NORMAL" button resets the speed which was changed by pressing either the "HIGH" or "LOW" button, to the predetermined value (0.0%).

⑦ Anti-skating knob

When a record is being played, a force which pulls the stylus towards the center of the turntable is generated. This force is compensated for by adjusting the Anti-skating knob.

⑧ Q damping knob Q DAMPING

The recommended amount of Q damping can be achieved by setting the Q damping knob to the same value as the stylus force.

⑨ Weight ring

Use this ring to obtain zero balance of the tonearm.

⑩ Arm rest

By holding the finger grip of the headshell and moving it to the left, the tonearm lock is disengaged. When locking the tonearm, push it in the opposite direction.

EXPLANATION OF THE MICROPROCESSOR

• **Motor Control IC IR3T05 (at standard revolution of 33 rpm)**

The numbers on the left hand side indicates the terminal number.

1. Stop output

during stop control: 0V
 during start: open

2. Lock indicator

during lock (LED lit dimly)
 69HZ

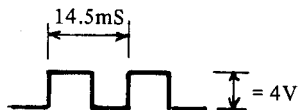

stop (LED lit)
 during transition (LED flashes)

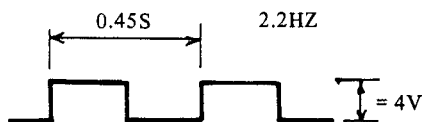

3. 0.22μs (0%)

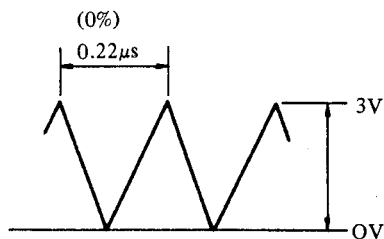

* Frequency will vary by changing turntable revolution within the range of ±9.9%.

4. rpm selector

H: 45 rpm
 L: 33 rpm

5. Power source input

Vcc: 5V ±0.5V

6. FGI bypass terminal

E6 ≙ ½ Vcc

7. FGI lowpass terminal

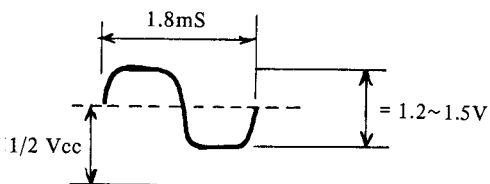

8. FGI output

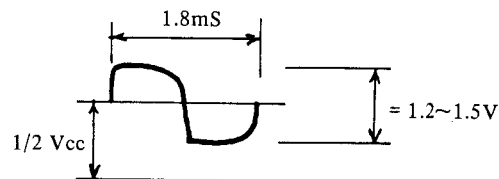

9. FGI inverse input

The gain set element is connected.
 E9 ≙ ½ Vcc

10. FGI non-inverse input

10mVpp ~ 100mVpp
 E10 ≙ ½ Vcc

11. FG II non-inverse input

10mVpp ~ 100mVpp
 E11 ≙ ½ Vcc

12. FG II inverse input

The gain set element is connected.
 E12 ≙ ½ Vcc

13. FG II output

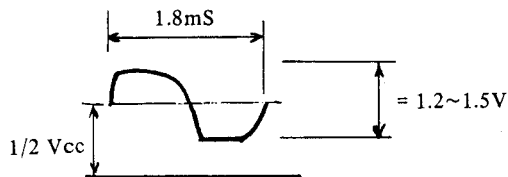

20. PD triangular wave

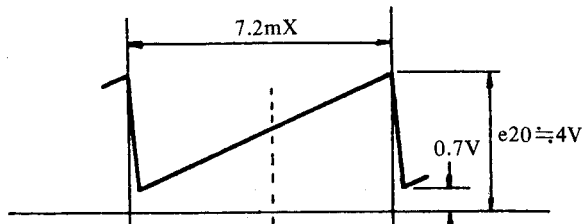

14. ground terminal

15. F/V output

slower than normal revolution: 2 ~ 4.5V
 normal revolution: ≈ 2V
 faster than normal revolution: 0 ~ 2V

21. Sample pulse monitor terminal

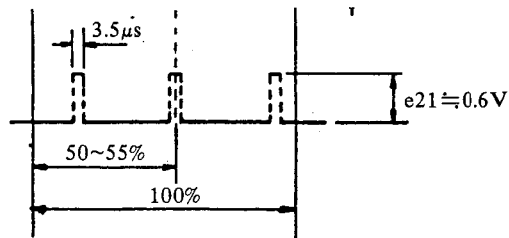

16. F/V hold terminal

same as terminal 15

23. PD hold terminal

slow phase: 2 ~ 4V
 normal phase: ≈ 2V
 advanced phase: 1 ~ 3V

17. F/V triangular wave

slower than normal revolution

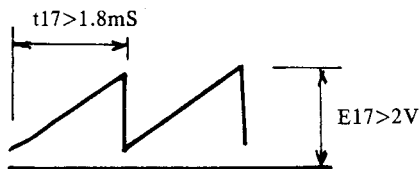

normal revolution

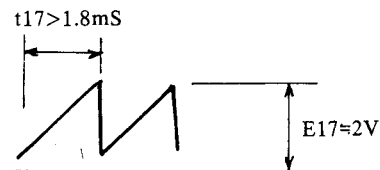

faster than normal revolution

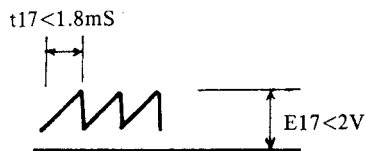

24. PD output

same as terminal 23

25. Lock detector time set terminal

during lock: 0.6V
 lock disengaged: 0V

26. Direction detector output

normal revolution: 0V
 reverse revolution: ≈ 4V

27. Revolution detector

during revolution  ≈ 4V
 stop: 0V

28. START/STOP terminal

H → START
 L → STOP

• TERMINAL FUNCTION EXPLANATION OF LF3735 PLL SPEED CONTROL

The serial numbers on the left hand side indicate the terminal numbers of LF3735.

- | | | |
|-----------------------|-----|--|
| 1) LCD segment output | S8 | } Output of converted pulses for indicating turntable revolution 33 or 45 and their $\pm 9.9\%$ variable revolution range. |
| 2) " " | S9 | |
| 3) " " | S10 | |
| 4) " " | S11 | |
| 5) " " | S6 | |
| 6) " " | S7 | |
| 7) LCD common output | H2 | |
| 8) " " | H1 | |
| 9) D/A output | | |

Output of periodic pulses inversely proportional to oscillation frequency.

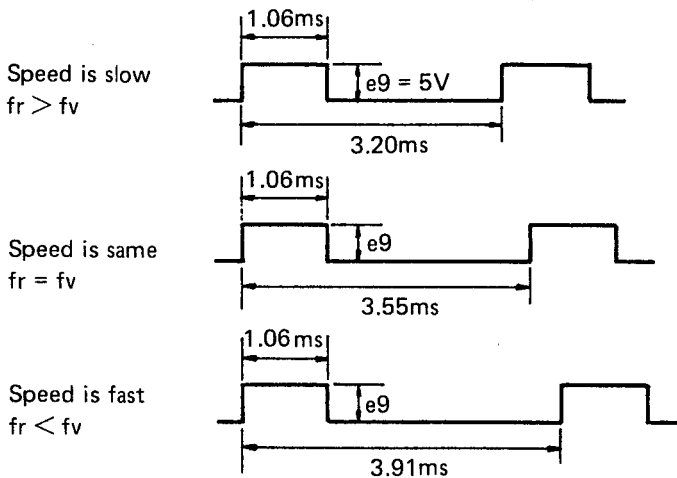

10) UP KEY input

Pushing the HIGH button momentarily shifts the input terminal from L to H and to increase the speed 0.1%.

Hold pushing the HIGH button increases the speed 0.4% per second until releasing the button, then the speed is set at this value.

11) DOWN KEY input

Each time to push the LOW button momentarily shifts the input terminal from L to H and to decrease the speed 0.1%.

Continuously pushing the LOW button decreases the speed 0.4% per second until releasing the button, then the speed is set at this value.

12) NORMAL KEY input

The speed is set to 0.0% when NORMAL KEY input terminal shifts from L to H.

13) 45/33rpm change input

Input terminal for LCD revolution indication.

H = 45rpm; L = 33rpm

14) X'tal input

By connecting 4.5MHz crystal oscillator to pins 14) 15) oscillates standard 4.5MHz frequency.

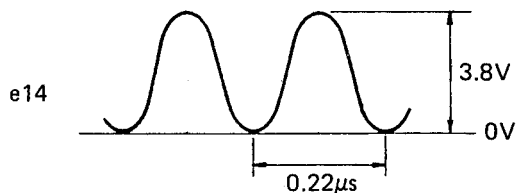

15) X'tal input

By connecting 4.5MHz crystal oscillator to pins 14) 15) oscillates standard 4.5MHz frequency.

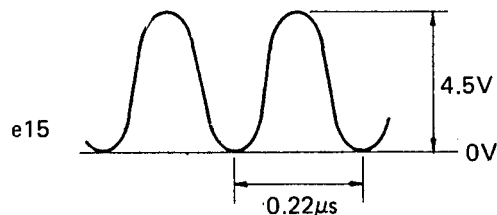

16) P terminal

The terminal normally not used. The terminal to compensate internal voltage controlled oscillator (VCO).

17) Reference frequency oscillation output

$f_0 = 4.5\text{MHz} \pm 9.9\%$ variable range

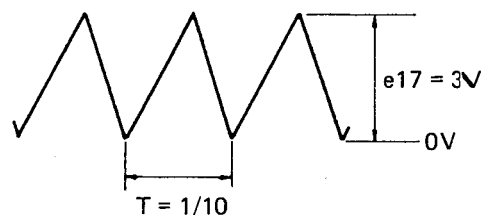

18) Power supply voltage

$V_{DD} = 5V$

19) Voltage controlled oscillator (VCO) input

| | | |
|--------|-------|--------|
| + 9.9% | 0% | - 9.9% |
| 3.43V | 3.08V | 2.78V |

Approx. 3.08VDC input for speed 0.0%

- 20) L.P.F. output
Output terminal to provide ripple signal in proportion to the phase difference to external Low Pass Filter (L.P.F.).
- 21) L.P.F. input
Input terminal to apply output signal from external Low Pass Filter (L.P.F.) to control voltage controlled oscillator (VCO).
- 22) Phase difference detection output
Output terminal of generated voltage in proportion to the phase difference of divided frequency f_r (phase ϕ_r) from X'tal and the frequency to set revolution f_v (phase ϕ_v).
- When phase ϕ_r is advanced from phase ϕ_v : L level
When phase ϕ_r is equal to phase ϕ_v : Open
When phase ϕ_r is delayed from phase ϕ_v : H level

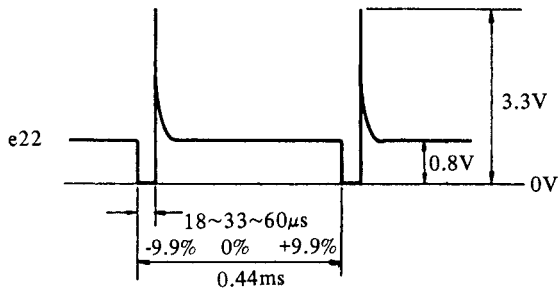

- 23) GND
Standard 0V potential for GND.
- 24) TEST
Test terminal for IC. By injecting a 250Hz or more higher frequency of clock pulse within the operating limits to increase UP/DOWN counting thus reduces time for operation test.
- 25) ACL
Immediately after the power is turned on, the primary input level becomes L level once prior to the operation starts.
- | | | |
|-----|----------------|--|
| 26) | LCD segment S1 | } Output of converted pulses for indicating turntable revolution 33 or 45 and their ±9.9% variable revolution range. |
| 27) | " S2 | |
| 28) | " S3 | |
| 29) | " S4 | |
| 30) | " S5 | |

ADJUSTMENT METHOD

• Adjusting the phonomotor section

Prepare a two-channel oscilloscope for the measuring instrument; make the adjustments in the following order.

CH-1 Probe connect to test point TP1 of the motor control circuit board, and CH-2 Probe connect to test point TP2.

Both probe ground terminal connect to G.

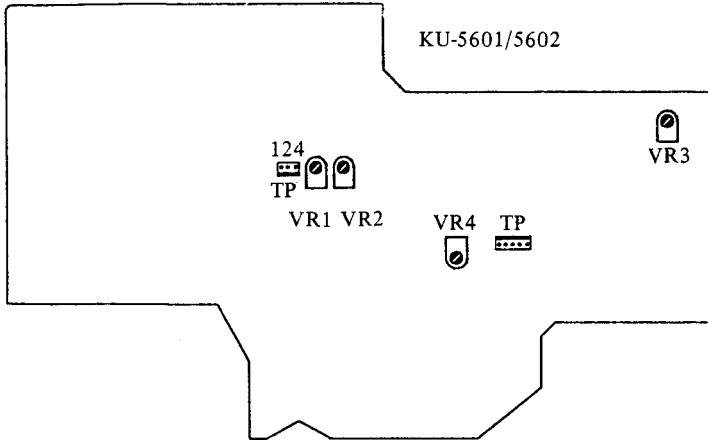

1. Adjusting the head gap

Make sure the detection head is Perpendicular to the magnetic coating surface of the turntable. The gap of the detection head should be adjusted to 0.18mm. Be careful the head is not tilted to the left or the right.

Note: If a gap is greater than the value, turntable will not stop promptly, and if a gap is lesser, turntable may revolute reversely after it stoped.

2. Lock adjustments for 45 rpm

- 1) Fix the arm to the armrest.
- 2) After pressing the start button, set the speed selector switch to 45 rpm.

Note: Make sure that the speed indication shows 0.0%.

- 3) Adjust VR2 so that the positions of the triangular wave form and the pulse form TP2 are as shown in the diagram below.

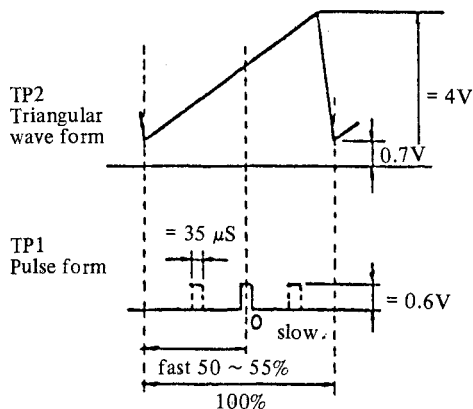

3. Lock adjustments for 33 rpm

- 1) Set the speed selector switch to 33 rpm and proceed to adjust VR1, just as in the adjustments for 45 rpm.

• Adjusting the arm control section

1. Horizontal Amp Off-set Voltage Adjustment

- 1) Fix the tonearm to the arm rest. Connect the high input resistance DC voltmeter (tester) between TP3 and TP4.
- 2) Adjust the voltage to $0 \pm 0.01V$ with VR3.

2. Lifter Amp Off-set Voltage Adjustment

- 1) Connect the DC voltmeter (tester) to TP303 and TP304 while short circuiting the test points TP302 and TP304.
- 2) Adjust the voltage to $0 \pm 0.1V$ with VR4.

3. End Detecting Position Adjustment

- 1) Fix the stylus point at a position 60 mm from the center spindle by using the straight arm.
- 2) Connect the DC voltmeter (tester) to the test points TP301 and TP304.
- 3) Adjust the voltage to $1.55 \pm 0.05V$ by adjusting the cam with a flat headed screwdriver. The cam adjustment hole is located at the back of the arm base.

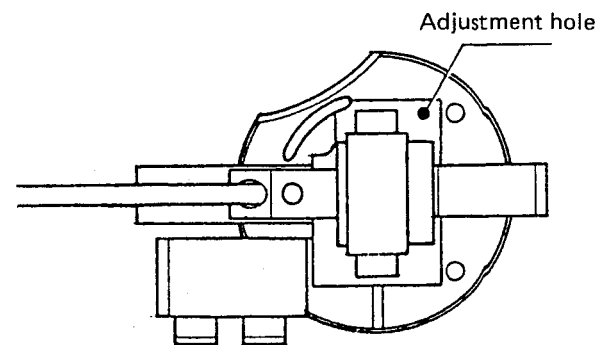

NOTE:

1. Be sure not to interfere with the function of any parts when connecting the measuring instrument for adjusting. Check that there is no loading resistance or loading capacity problem. Refer to the following example for the exact measuring technique.
2. While adjusting or measuring the detecting positions, close the bottomplate or cover the unit with a black cloth or paper so that no light enters. Also when adjusting the speed detector, be sure no magnetic sources are near and that there are no vibrations.

*** Speed Adjustment**

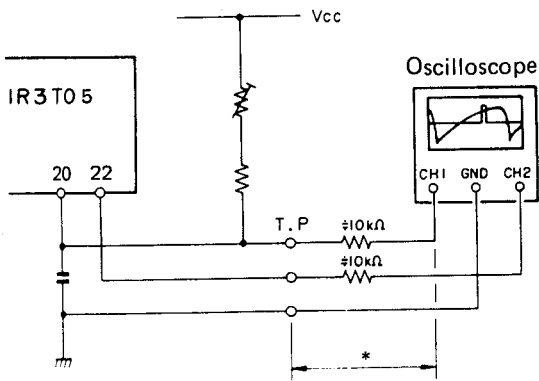

* Keep the wire as short as possible. If it is long, connect the resistors in series.

*** Off-set Voltage Measurement**

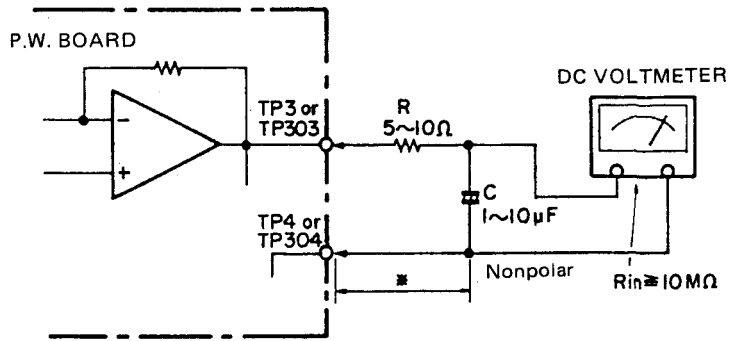

* This distance should be as short as possible.

*** FG Signal Check or Wow/Flutter Measurement**

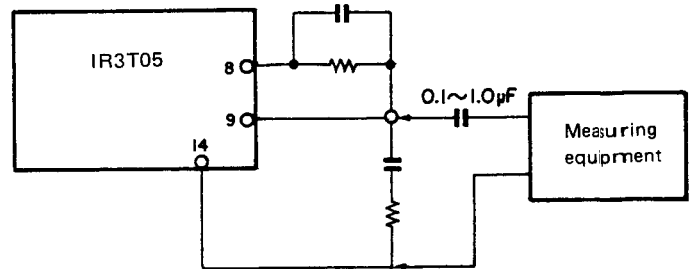

By utilizing the legs of parts as much closer to the IC pins as possible to connect a measuring equipment.

WARNING:

1. Component parts

Parts marked with \triangle and/or shading in this service manual have special characteristics important to safety. Be sure to use the specified parts for replacement.

2. Leakage current

Before returning the appliance to customer, test the leakage current when the power plug is connected. Use a calibrated (with an error of not more than 5%) leakage current tester and measure the leakage current from any exposed metal to the earth ground. Reverse the power plug polarity and test the above again.

Any current measured **MUST NOT EXCEED 0.5 milliamps**. Corrective measure must be taken if it exceeds the limit.

PARTS LIST OF EXPLODED VIEW

| Ref. No. | Part No. | Part Name | Remarks |
|----------|------------|----------------------|--------------|
| 1 | 1468173303 | FRAME | |
| 2 | 4118312602 | SHIELD PLATE | |
| 2 | 4118312615 | SHIELD PLATE | (E1) |
| ⚠ | 3 | 2178077109 | MOTOR |
| 4 | 4753100004 | 4TWA | |
| 5 | 4713411018 | 4x25 CBS | |
| 6 | 1018437716 | CABINET ASS'Y | |
| 6 | 1018437729 | CABINET ASS'Y | (E1) |
| 7 | 4418245000 | BUSHING PLATE (D) | |
| 7 | 4418244302 | BUSHING PLATE (C) | (E1) |
| 8 | 4418584004 | BUSHING PLATE (H) | |
| 9 | 4018006209 | HINGE | |
| 10 | 4720307034 | 3.1x13 CRWS | |
| 11 | 4498079005 | LOCKING SUPPORT | |
| 12 | EP-4772 | CORD HOLDER | |
| 13 | 4733305010 | 3x10 CBTS (1) | |
| 14 | FPR0464-3 | DENON MARK | |
| 15 | 4732309017 | 3x16 CFTS (1) | |
| 16 | 4733808009 | 3x25 CBTS (1) | |
| 17 | 3918425004 | MAGNETIC HEAD ASS'Y | |
| 18 | 4700010011 | 3x8 CPS W | |
| 19 | 3159000408 | TONE ARM ASS'Y | |
| 20 | 4128864108 | VOLUME BRACKET | |
| 21 | 1128093202 | VOLUME KNOB | |
| 22 | 4733809011 | 4x25 CBTS (1) | |
| 23 | 4128865204 | OVER PLATE | |
| 24 | 4730306012 | 3x12 CBRTS (1) | |
| 25 | WA-0107H4 | WASHER | |
| 26 | 1038267306 | CONTROL PANEL ASS'Y | |
| 27 | 1138204308 | LIFTER KNOB ASSY | |
| 28 | 4610224007 | CUSHION | |
| 29 | 1138205307 | PUSH KNOB (B) ASS'Y | |
| 30 | KU-56011 | SERVO CONTROL UNIT | (E2) |
| 30 | KU-56021 | SERVO CONTROL UNIT | (E1) |
| 31 | 4730304014 | 3x8 CBRTS (1) | |
| 32 | 4428228101 | FIXING BASE | |
| 33 | 1038268305 | POWER SW PANEL ASS'Y | |
| 34 | 1138027307 | PUCH KNOB (A) ASS'Y | |
| 35 | 4610222106 | CUSHION | |
| 36 | 4751106042 | WASHER | |
| 37 | KU-56012 | SERVO CONTROL UNIT | (E2) |
| 37 | KU-56022 | SERVO CONTROL UNIT | (E1) |
| ⚠ | 38 | 2129136015 | POWER SWITCH |
| 39 | 4428229100 | POWER SW BRACKET | |
| 40 | 4713303016 | 3x6 CBS | |
| 41 | 1140056007 | FLEXIBLE RING | |
| 42 | 1138206209 | POWER KNOB ASS'Y | |
| 43 | 4737002005 | 3x6 CBTS (S) | |
| ⚠ | 44 | 2335497001 | POWER TRANS |
| ⚠ | 44 | 2335496002 | POWER TRANS |
| 45 | 4620027003 | RUBBER BUSH | |
| 46 | 4438158067 | COLLAR | |
| 47 | 4730310011 | 3x20 CBRTS (1) | |
| 48 | 4118452106 | ARM CHASSIES | |
| 49 | 4248019202 | ADJUST CAM | |
| 50 | 3158451003 | FRICTION WASHER | |
| 51 | 4751005004 | 4W | |
| 52 | 4761003009 | 3E RING | |
| 53 | 4358022008 | COLLAR | |
| 54 | 4418938207 | SENSOR PLATE | |
| 55 | 4338180009 | YOKE (A) ASS'Y | |
| 56 | 4744304000 | 3x3 BSS (D) | |
| 57 | 3468136102 | COIL ASS'Y | |
| 58 | 4730356017 | 3x12 CBRTS (2) | |

| Ref. No. | Part No. | Part Name | Remarks |
|----------|------------|--------------------|-------------------|
| 59 | 4638221008 | SPRING | |
| 60 | 3418017200 | MAGNET ASS'Y | |
| 61 | KU-56014 | SERVO CONTROL UNIT | (E2) |
| 61 | KU-56024 | SERVO CONTROL UNIT | (E1) |
| 62 | KU-56015 | SERVO CONTROL UNIT | (E2) |
| 62 | KU-56025 | SERVE CONTROL UNIT | (E1) |
| 63 | 4468100205 | SENSOR HOLDER | |
| 64 | 4713314018 | 3x35 CBS | |
| 65 | 2178065205 | MOTOR C ASS'Y | |
| 66 | 4128681006 | MOTOR BRACKET | |
| 67 | 4148170018 | PLATE | |
| 68 | 4148170005 | PLATE | |
| 69 | 4248021203 | LIFTER CAM | |
| 70 | 4730812001 | 3x8 CPTS (2) | |
| 71 | 4338212000 | SHUTTER | |
| 72 | 4712304016 | 3x8 CFS | |
| 73 | 4418926206 | ARM BRACKET | |
| 74 | KU-56013 | SERVO CONTROL UNIT | (E2) |
| 74 | KU-56023 | SERVO CONTROL UNIT | (E1) |
| ⚠ | 75 | 2062002031 | AC CORD WITH PLUG |
| ⚠ | 75 | 2006031026 | AC CORD |
| 76 | - | - | |
| ⚠ | 77 | 4450020005 | CORD BUSH |
| ⚠ | 77 | MD-3802 | BUSHING |
| 78 | 2039616010 | OUTPUT CORD | |
| 79 | 4458024003 | CORD BUSH | |
| 80 | 2098309009 | SOLDERING WIRE | |
| 81 | 4148173002 | SHIELD COVER | |
| 82 | 1058111306 | BOTTOM BOARD ASS'Y | |
| 83 | 4610219009 | DAMPER PLATE | |
| 84 | 4420007003 | DAMPING BLOCK | |
| 85 | 1048081307 | INSULATOR ASS'Y | |
| 86 | 4218417106 | RECORDED TURNTABLE | |
| 87 | 4218094040 | RUBBER SHEET | |
| 88 | KU-5601 | SERVO CONTROL UNIT | (E2) |
| 88 | KU-5602 | SERVO CONTROL UNIT | (E1) |
| 89 | 1468076031 | DUST COVER ASS'Y | |
| 90 | FPR0460 | DENON MARK | |
| 91 | 4628006107 | BUSHING | |
| 92 | FTS0701 | HINGE PLATE | |
| 93 | 4712404055 | 4x8 CFS | |
| 94 | - | - | |
| 95 | 4713809002 | 4x25 CBS (R) | |
| 96 | 2118082002 | V16V15KB102 | ANTI |
| 97 | 2118081003 | V1620V15KB102B102 | Q. DAMP |
| 98 | 4730812001 | 3x8 CPTS (2) | |
| 99 | PS-1680 | POWER SUPPLY UNIT | (E1) |
| 99 | PS-1670 | POWER SUPPLY UNIT | (E2) |
| 100 | 2123315023 | VOLTAGE SELECTOR | (E1) |
| 101 | 4730205016 | 2.6x10 CPTS (1) | (E1) |

Remarks symbols in the parts list refer to the following countries and areas.

EU : U.S.A.

E1 : Multiple voltage model

E2 : European continent

EXPLODED VIEW

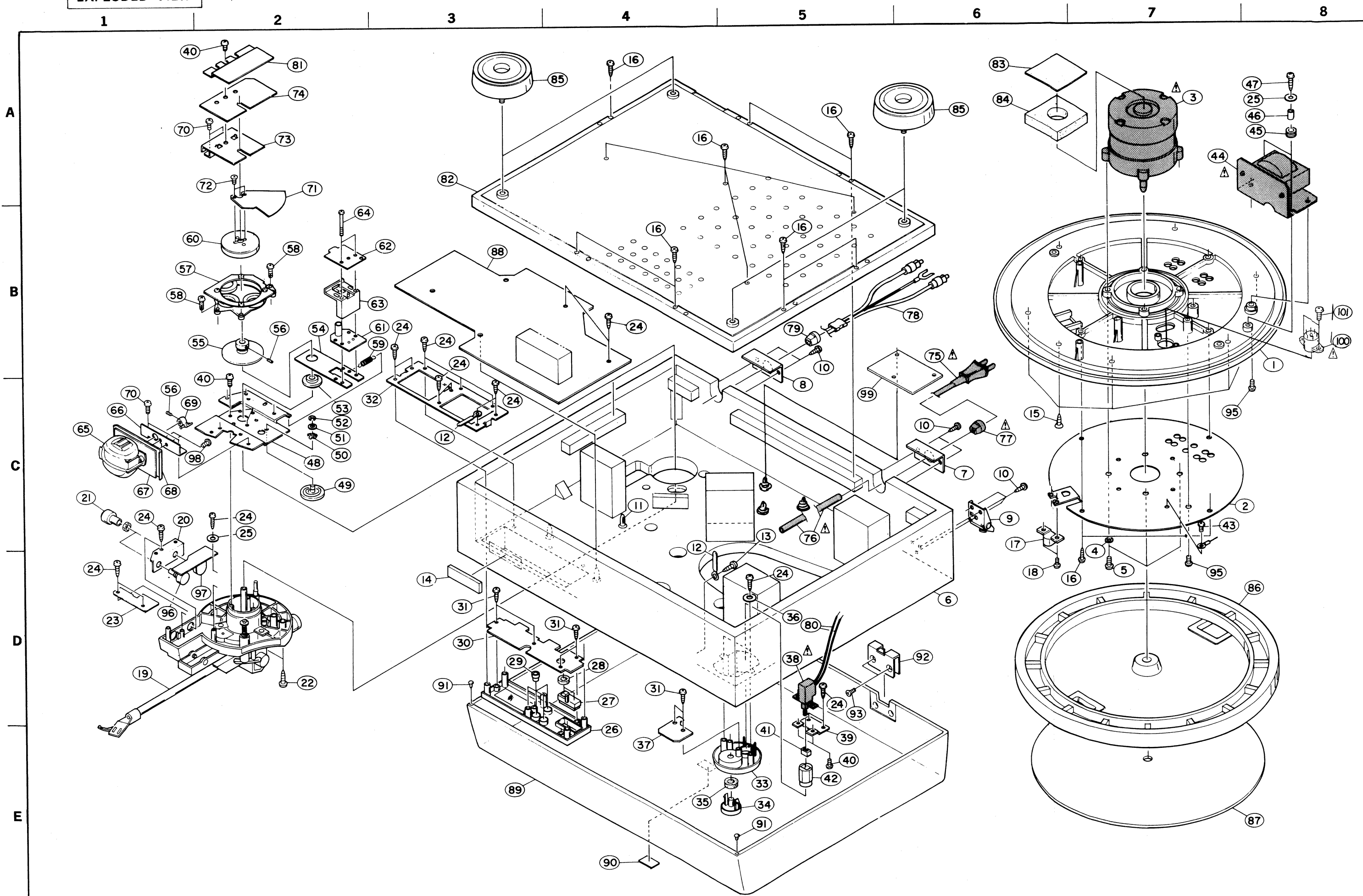

SCHEMATIC DIAGRAM

**DP-59 L
CIRCUIT DIAGRAM**

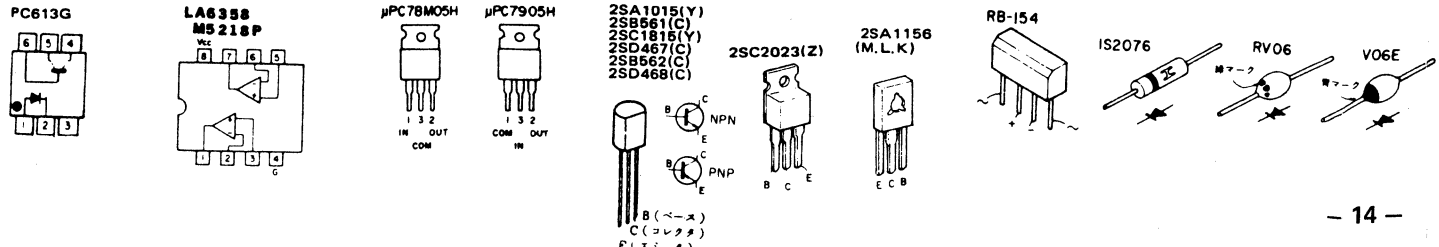
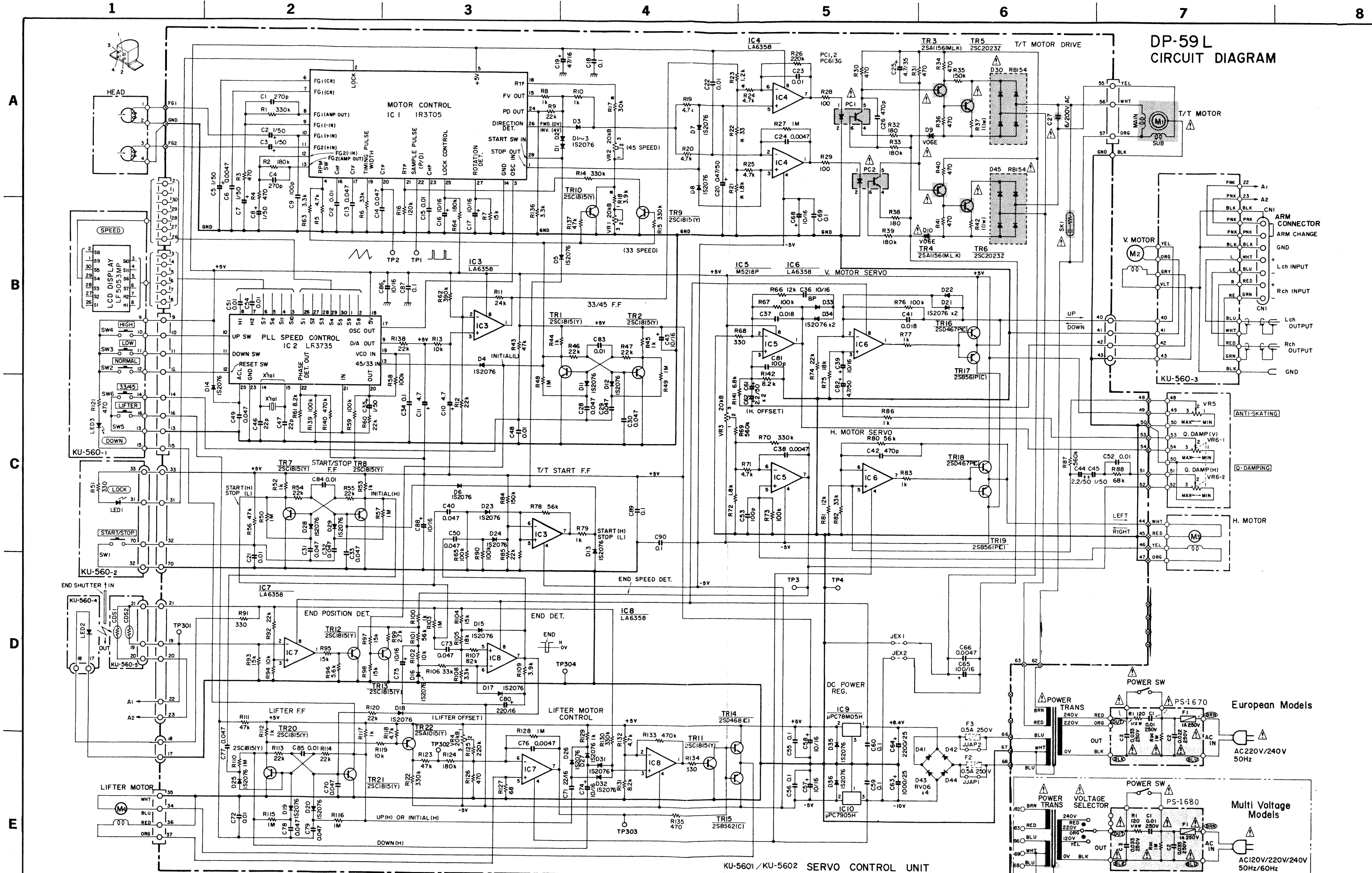

Note:

- Resistance shall be 1/4W unless otherwise specified and the unit is Ω.
- The unit of capacitor is μF, P is pF unless otherwise specified.
- This circuit diagram shows the basic circuit. It is subject to change for the purpose of improvement.
- Parts marked with Δ are of importance in respect to the safety, use the specified type without fail.

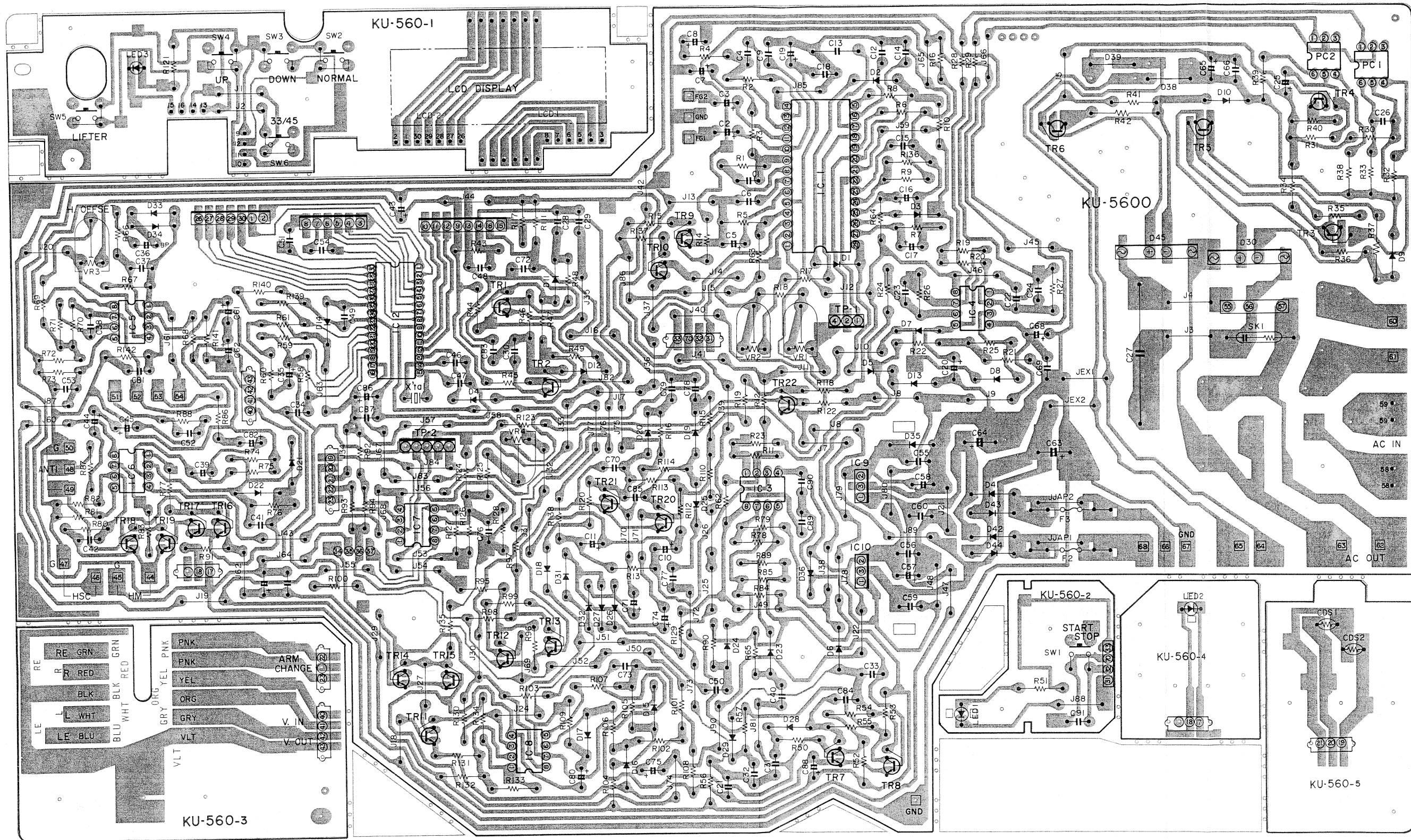

PARTS LIST OF P.W. BOARD

KU-5601/5602 SERVO CONTROL UNIT

| Ref. No. | Part No. | Part Name | Remarks |
|----------------------------|------------|-----------------|-----------------------|
| SEMICONDUCTOR GROUP | | | |
| IC1 | 2630320006 | IR3T05 | |
| IC2 | 2620556000 | LR3735 | |
| IC3, 4 | 2630237005 | LA6358 | |
| 6, 7, 8 | | | |
| IC5 | 2630257001 | M5218P | |
| IC9 | 2630147001 | μPC78M05H | |
| IC10 | 2630160004 | μPC7905H | |
| TR1, 2 | 2730198002 | 2SC1815 (Y) | |
| 7~13 | | | |
| 20, 21 | | | |
| TR3, 4 | 2710159003 | 2SA1156 (M.L.K) | |
| TR5, 6 | 2730196004 | 2SC2023Z | |
| TR14 | 2740036002 | 2SD468 (C) | |
| TR15 | 2720025004 | 2SB562 (C) | |
| TR16, 18 | 2740038000 | 2SD467 (P) | |
| TR17, 19 | 2720046009 | 2SB561P (C) | |
| TR22 | 2710102005 | 2SA1015 (Y) | |
| D1~8 | 2760049008 | 1S2076 | |
| 11~29 | | | |
| 31~36 | | | |
| D9, 10 | 2760057029 | V06E | |
| D30, 45 | 2760280003 | RB154 | |
| D41~44 | 2760237001 | RV06 | |
| PC1, 2 | 3939027012 | PC-613G | |
| CD1, 2 | 3939053028 | CDS | |
| LE1, 2 | 3939041001 | LN81RP-HL | |
| LE3 | 3939223007 | LD101VR | |
| | 3939267005 | LF5053MP | |
| RESISTOR GROUP | | | |
| R17 | 2452218008 | RN14K2E303G | Metal film 30KΩ ¼W |
| R18 | 2452197006 | RN14K2E392G | 3.9KΩ ¼W |
| R21 | 2452189001 | RN14K2E182G | 1.8KΩ ¼W |
| R22 | 2452147001 | RN14K2E330G | 33Ω ¼W |
| R23 | 2452185005 | RN14K2E122G | 1.2KΩ ¼W |
| R37, 42 | 2440005029 | RS14B3A010JNBF | 1Ω 1W |
| VR1~4 | 2116019035 | K08PB203 | 20KΩB |
| CAPACITOR GROUP | | | |
| C21, 48 | 2531024003 | CK45F1H103Z | Ceramic 0.01μF 50V |
| 51, 54 | | | |
| 72, 83 | | | |
| 84, 91 | | | |
| C26, 42 | 2531002009 | CK45B1H471K | 470PF 50V |
| C24, 66 | 2531008003 | CK45B1H472K | 4700PF 50V |
| 76 | | | |
| C18, 34 | 2539036006 | CK45=1E104Z | 0.1μF 25V |
| 55, 56 | | | |
| 59, 60, 69, | | | |
| 87, 89, 90 | | | |

| Ref. No. | Part No. | Part Name | Remarks |
|--------------------------|------------|---------------|---------------------------|
| C85 | 2531024003 | CK45F1H103Z | 0.01μF 50V |
| C46, 47 | 2533611003 | CC45SL1H220J | 22PF 50V |
| C1, 4 | 2533637003 | CC45SL1H271J | 270PF 50V |
| C53, 81, 9 | 2533627000 | CC45SL1H101J | 100PF 50V Electrolytic |
| C20 | 2544145005 | CE04W1HR47= | 0.47μF 50V |
| C2, 3 | 2544146004 | CE04W1H010= | 1μF 50V |
| 5, 7 | | | |
| 8, 35 | | | |
| 45 | | | |
| C44, | 2544147003 | CE04W1H2R2= | 2.2μF 50V |
| 61, 62 | | | |
| C11, 25 | 2544140000 | CE04W1V4R7= | 4.7μF 35V |
| 82 | | | |
| C16, 17 | 2544132005 | CE04W1C100= | 10μF 16V |
| 39, 57 | | | |
| 58, 68 | | | |
| 74, 75 | | | |
| 43, 86 | | | |
| 88 | | | |
| C19 | 2544135002 | CE04W1C470= | 47μF 16V |
| C65 | 2544136001 | CE04W1C101= | 100μF 16V |
| C71 | 2544133004 | CE04W1C220= | 22μF 16V |
| C80 | 2544131006 | CE04W1A221= | 220μF 10V |
| C63 | 2544080005 | CE04W1E102M | 1000μF 25V |
| C64 | 2544086009 | CE04W1E222M | 2200μF 25V |
| C10 | 2544140000 | CE04W1V4R7= | 4.7μF 35V |
| C36 | 2543014027 | CE04D1C100MBP | 10μF 16V |
| C12, 15 | 2551072006 | CQ93M1H103K | 0.01μF 50V |
| 22, 23 | | | |
| 53 | | | |
| C37, 41 | 2551121054 | CQ93M1H183J | 0.018μF 50V |
| C14 | 2551122008 | CQ93M1H473J | 0.047μF 50V |
| C28~33 | 2551080001 | CQ93M1H473K | 0.047μF 50V |
| 40, 49 | | | |
| 50, 70 | | | |
| 73 | | | |
| 77~79 | | | |
| C6, 38 | 2551068007 | CQ93M1H472K | 4700PF 50V |
| C13 | 2554194017 | CQ93P1H473J | 0.047μF 50V |
| C27 | 2568013087 | CF99=2DAC605J | 6μF AC200V |
| OTHER PARTS GROUP | | | |
| SK1 | 4178028101 | HEAT SINK | |
| | 4178020400 | HEAT SINK | |
| | 4618161007 | CUSHION | |
| | 3998023002 | CRYSTAL | 4.5MHZ |
| | FEP0429K | SPARK KILLER | |
| | 2124388004 | TACT SWITCH | |
| | 4438568107 | LED HOLDER | |

• The carbon resistors rated at ¼W are not listed herein.

P. W. BOARD OF POWER SUPPLY UNIT

PS-1670/1680 POWER SUPPLY UNIT

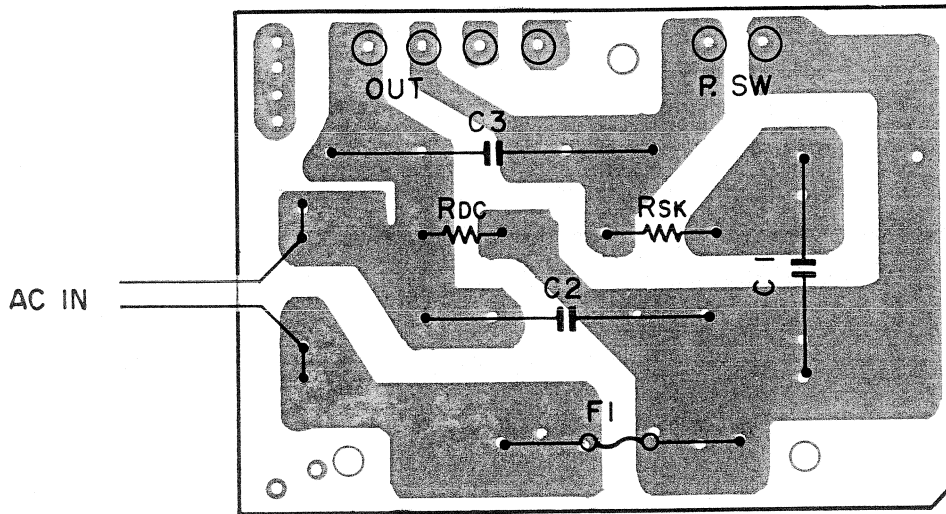

PARTS LIST OF P.W. BOARD

PS-1670 POWER SUPPLY UNIT

| Ref. No. | Part No. | Part Name | Remarks |
|--------------------------|------------|---------------|----------------------|
| RESISTOR GROUP | | | |
| R-DC | 2410765001 | RD14B2E105J | 1M Ω 1/4W |
| R-SK | 2410163001 | RD14B2H121J | 120 Ω 1/2W |
| CAPACITOR GROUP | | | |
| C1 | 2568023006 | CF93A2EAC103M | 0.01 μ F 250VAC |
| C2 | 2568023019 | CF93A2EAC223M | 0.022 μ F 250VAC |
| C3 | 2568023022 | CF93A2EAC333M | 0.033 μ F 250VAC |
| OTHER PARTS GROUP | | | |
| | EE-1656 | BASE TERMINAL | |
| | 2061015029 | FUSE | 1A/250V |
| | FEP1287 | FUSE HOLDER | |
| | 2050087042 | 4P TERMINAL | |
| | 2050087026 | 2P TERMINAL | |

WARNING:

Parts marked with and/or shading have special characteristics important to safety. Be sure to use the specified parts for replacement.

PS-1680 POWER SUPPLY UNIT

| Ref. No. | Part No. | Part Name | Remarks |
|--------------------------|------------|---------------|----------------------|
| RESISTOR GROUP | | | |
| R-DC | 2410765001 | RD14B2E105J | 1M Ω 1/4W |
| R-SK | 2410163001 | RD14B2E121J | 120 Ω 1/2W |
| CAPACITOR GROUP | | | |
| C1 | 2568023019 | CF93A2EAC223M | 0.022 μ F 250VAC |
| C2, 3 | 2568023022 | CF93A2EAC333M | 0.033 μ F 250VAC |
| OTHER PARTS GROUP | | | |
| | EE-1656 | BASE TERMINAL | |
| | EP-72663 | FUSE | 1A/250V |
| | 2050087042 | 4P TERMINAL | |
| | 2050087026 | 2P TERMINAL | |

ACCESSORIES AND PACKING GROUP

| Ref. No. | Part No. | Part Name | Remarks |
|----------|------------|-----------------------|-----------|
| | 5050025072 | CABINET COVER | |
| | 5058133102 | PACKING (D) | |
| | 5058134208 | PACKING (U) | |
| | 5298004004 | MINI DRIVER | |
| | 3158547001 | SHELL ACCESSORY ASS'Y | |
| | 5298006002 | 45 ADAPTOR | |
| | 5058006006 | ENVELOPE | |
| | 5298042105 | OVER HANG GAUGE | |
| | 5028010103 | ACCESSORY COVER | |
| | 5050112008 | SIDE PACKING | |
| | 5028014206 | PACKING | |
| | 5111288004 | INSTRUCTION MANUAL | |
| | 2033667007 | PLUG ADAPTER | (E1 only) |

DENON



NIPPON COLUMBIA CO., LTD.

No. 14-14, 4-CHOME AKASAKA,
MINATO-KU, TOKYO JAPAN

TEL: 03-584-8111

TLX: JAPANOLA J22591

CABLE: NIPPON COLUMBIA TOKYO