

Service Manual

 **PIONEER®**
The Art of Entertainment

DEH-68/UC



ORDER NO.
CRT2017

HIGH POWER CD PLAYER WITH ID-LOGIC TUNER

DEH-68 UC

DEH-635 UC

HIGH POWER CD PLAYER WITH FM/AM TUNER

DEH-58 UC

DEH-535 UC

DEH-53 UC

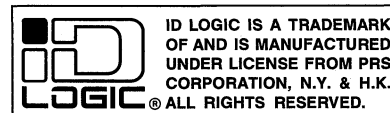

COMPACT
disc
DIGITAL AUDIO

- See the separate manual CX-597(CRT1829) for the CD mechanism description, disassembly and circuit description.
- The CD mechanism employed in this model is one of CX-597 series.

CONTENTS

1. SAFETY INFORMATION	2	7. GENERAL INFORMATION	61
2. EXPLODED VIEWS AND PARTS LIST	3	7.1 PARTS	61
3. SCHEMATIC DIAGRAM	12	7.1.1 IC.....	61
4. PCB CONNECTION DIAGRAM	38	7.1.2 DISPLAY	70
5. ELECTRICAL PARTS LIST	48	7.2 DIAGNOSIS	71
6. ADJUSTMENT.....	57	7.2.1 DISASSEMBLY	71
		7.2.2 TEST MODE	72
		7.3 BLOCK DIAGRAM	76
		8. OPERATIONS AND SPECIFICATIONS.....	78

PIONEER ELECTRONIC CORPORATION 4-1, Meguro 1-Chome, Meguro-ku, Tokyo 153, Japan
PIONEER ELECTRONICS SERVICE INC. P.O.Box 1760, Long Beach, CA 90801-1760 U.S.A.
PIONEER ELECTRONIC [EUROPE] N.V. Haven 1087 Keetberglaan 1, 9120 Melsele, Belgium
PIONEER ELECTRONICS ASIACENTRE PTE.LTD. 501 Orchard Road, #10-00, Lane Crawford Place, Singapore 0923

© PIONEER ELECTRONIC CORPORATION 1997

K-FFA. FEB. 1997 Printed in Belgium

DEH-68,635,58,535,53

● CD Player Service Precautions

1. For pickup unit(CXX1230) handling, please refer to "Disassembly"(CX-597 Service Manual CRT1829).
During replacement, handling precautions shall be taken to prevent an electrostatic discharge(Protection by a short pin).
2. During disassembly, be sure to turn the power off since an internal IC might be destroyed when a connector is plugged or unplugged.
3. Please check the grating after changing the service pickup unit(see page 59).
4. This device employs an inverter as the power supply for the EL. Utmost care should be used not to suffer from a possible electric shock, accordingly.

1. SAFETY INFORMATION

CAUTION

This service manual is intended for qualified service technicians; it is not meant for the casual do-it-yourselfer. Qualified technicians have the necessary test equipment and tools, and have been trained to properly and safely repair complex products such as those covered by this manual. Improperly performed repairs can adversely affect the safety and reliability of the product and may void the warranty. If you are not qualified to perform the repair of this product properly and safely; you should not risk trying to do so and refer the repair to a qualified service technician.

WARNING

Lead in solder used in this product is listed by the California Health and Welfare agency as a known reproductive toxicant which may cause birth defects or other reproductive harm (California Health & Safety Code, Section 25249.5). When servicing or handling circuit boards and other components which contain lead in solder, avoid unprotected skin contact with the solder. Also, when soldering do not inhale any smoke or fumes produced.

2. EXPLODED VIEWS AND PARTS LIST

2.1 PACKING

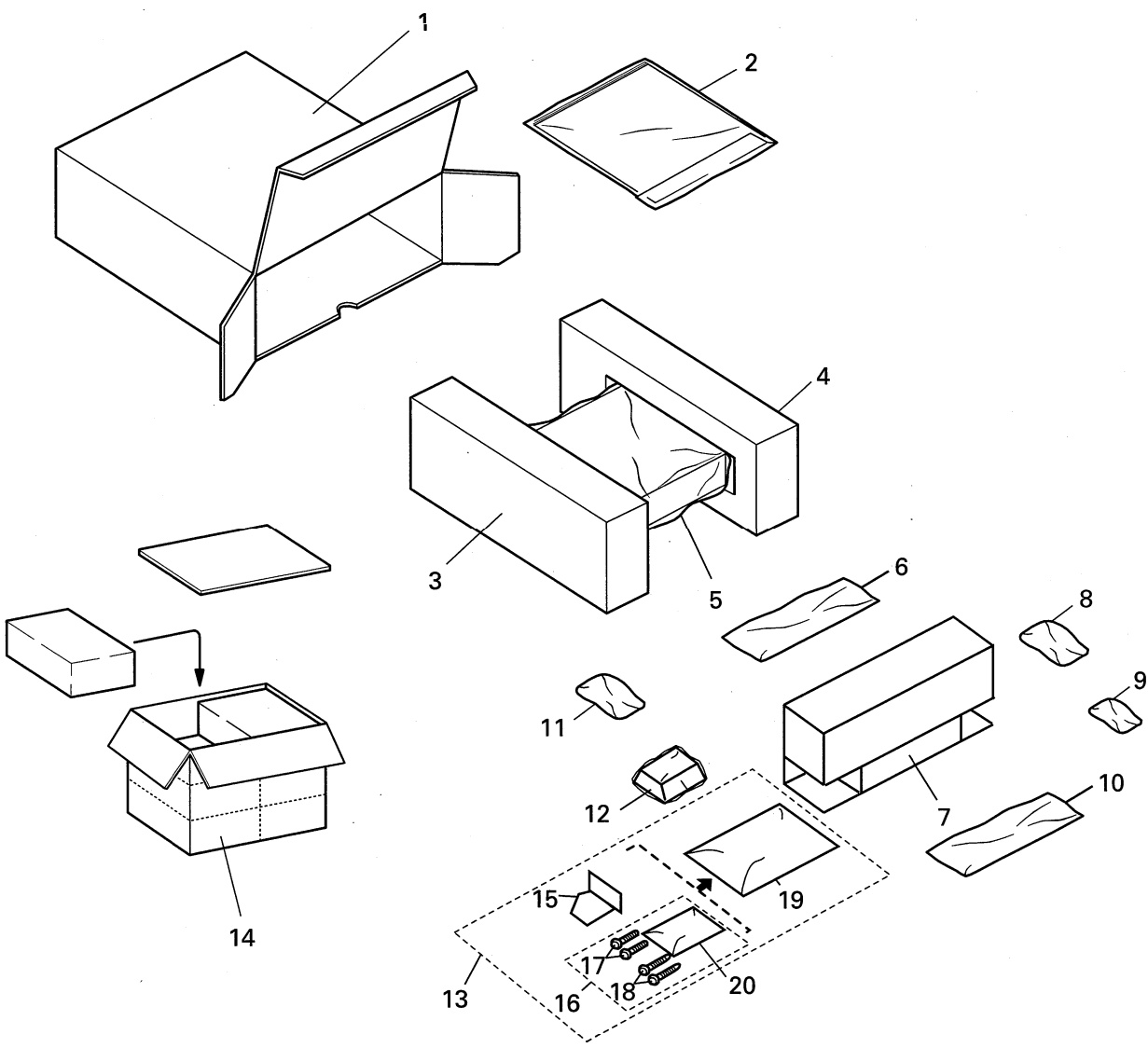

Fig. 1

DEH-68,635,58,535,53

NOTE:

- Parts marked by “*” are generally unavailable because they are not in our Master Spare Parts List.
- Screws adjacent to ▼ mark on the product are used for disassembly.

● **Parts List**

Mark No. Symbol & Description	Part No.				
	DEH-68/UC	DEH-635/UC	DEH-58/UC	DEH-535/UC	DEH-53/UC
1 Carton	CHG3245	CHG3244	CHG3252	CHG3250	CHG3251
2-1 Owner's Manual	CRD2264	CRD2267	CRD2266	CRD2269	CRD2269
2-2 Installation Manual	CRD2265	CRD2268	CRD2379	CRD2270	CRD2271
* 2-3 Label	CRW1343	CRW1343	CRW1343	Not used	Not used
* 2-4 Warranty Card	CRY1070	Not used	CRY1070	Not used	Not used
* 2-5 Card	Not used	ARY1048	Not used	ARY1048	ARY1048
2-6 Polyethylene Bag	CEG1116	CEG1116	CEG1116	CEG1116	CEG1116
3 Protector	CHP1766	CHP1766	CHP1766	CHP1766	CHP1766
4 Protector	CHP1767	CHP1767	CHP1767	CHP1767	CHP1767
5 Polyethylene Bag	CEG1173	CEG1173	CEG1173	CEG1173	CEG1173
6 Cord Assy	CDE5186	CDE5186	CDE5186	CDE5324	CDE5324
7 Inner Box	CHW1628	CHW1628	Not used	Not used	Not used
8 Remote Control Assy	CXB1160	CXB1160	CXB1225	CXB1225	CXB1225
9 Battery	CEX1006	CEX1006	CEX1030	CEX1030	CEX1030
10 Case Assy	CXB1063	CXB1063	CXB1063	CXB1063	CXB1063
11 Accessory Assy	CEA1918	CEA1918	CEA1918	CEA1918	CEA1918
12 Base Assy	CEA2344	CEA2344	Not used	Not used	Not used
12-1 Polyethylene Bag	CZE3188	CZE3188	Not used	Not used	Not used
* 13 Bracket Assy	CEA2346	CEA2346	Not used	Not used	Not used
14 Contain Box	CHL3245	CHL3244	CHL3252	CHL3250	CHL3251
15 Bracket	CZN6467	CZN6467	Not used	Not used	Not used
16 Screw Assy	CZE3198	CZE3198	Not used	Not used	Not used
17 Screw	BPZ30P100FZK	BPZ30P100FZK	Not used	Not used	Not used
18 Screw	BNC40P120FZK	BNC40P120FZK	Not used	Not used	Not used
* 19 Polyethylene Bag	CZE3201	CZE3201	Not used	Not used	Not used
* 20 Polyethylene Bag	CEG-127	CEG-127	Not used	Not used	Not used

● **Owner's Manual, Installation Manual**

Model	Part No.	Language
DEH-68/UC	CRD2264	English, French
	CRD2265	English, French
DEH-635/UC	CRD2267	English, French
	CRD2268	English, French
DEH-58/UC	CRD2266	English, French
	CRD2379	English, French
DEH-535/UC, DEH-53/UC	CRD2269	English, French, Spanish
DEH-535/UC	CRD2270	English, French, Spanish
DEH-53/UC	CRD2271	English, French, Spanish

● Accessory Assy

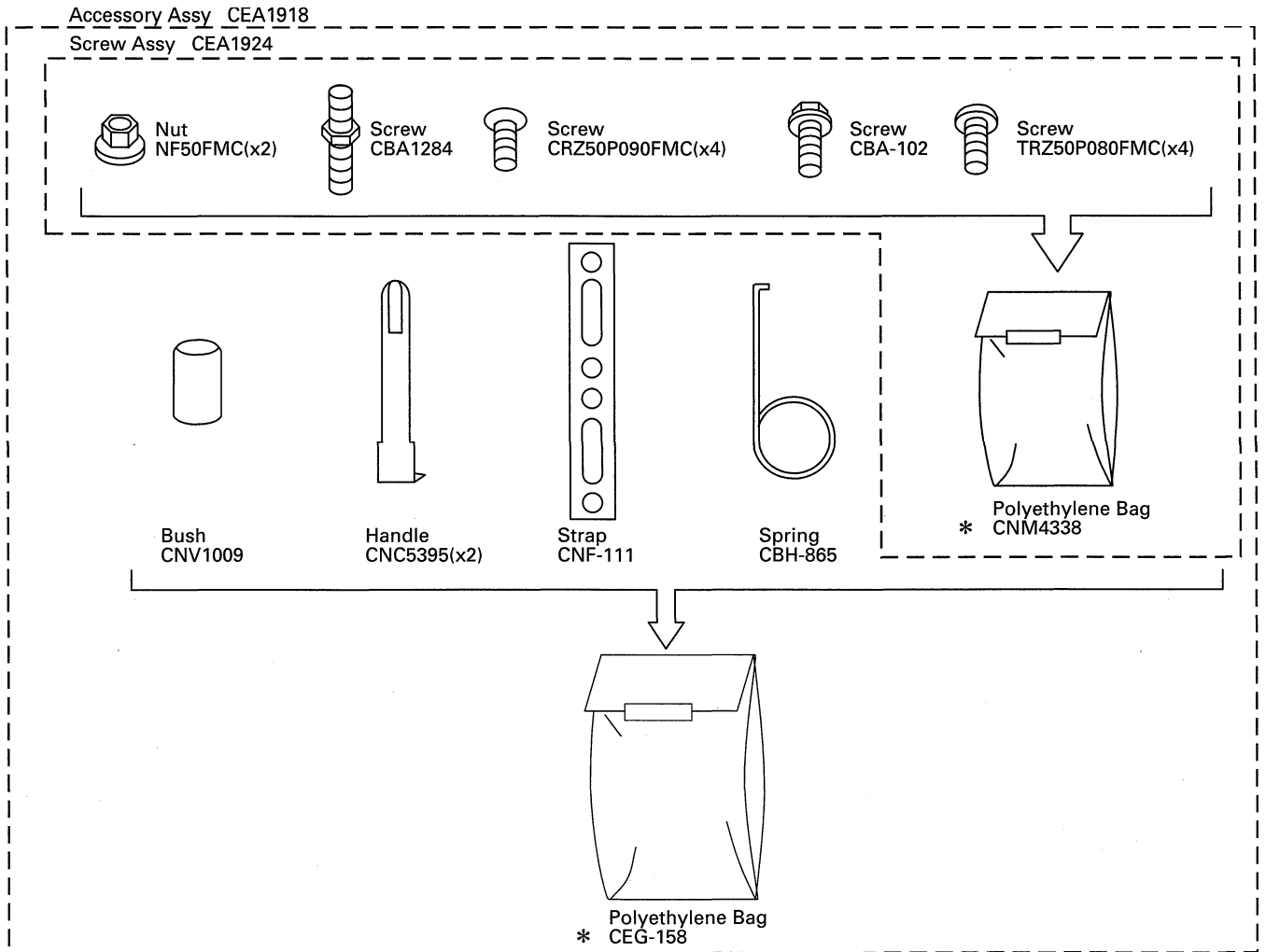

Fig. 2

DEH-68,635,58,535,53

2.2 EXTERIOR

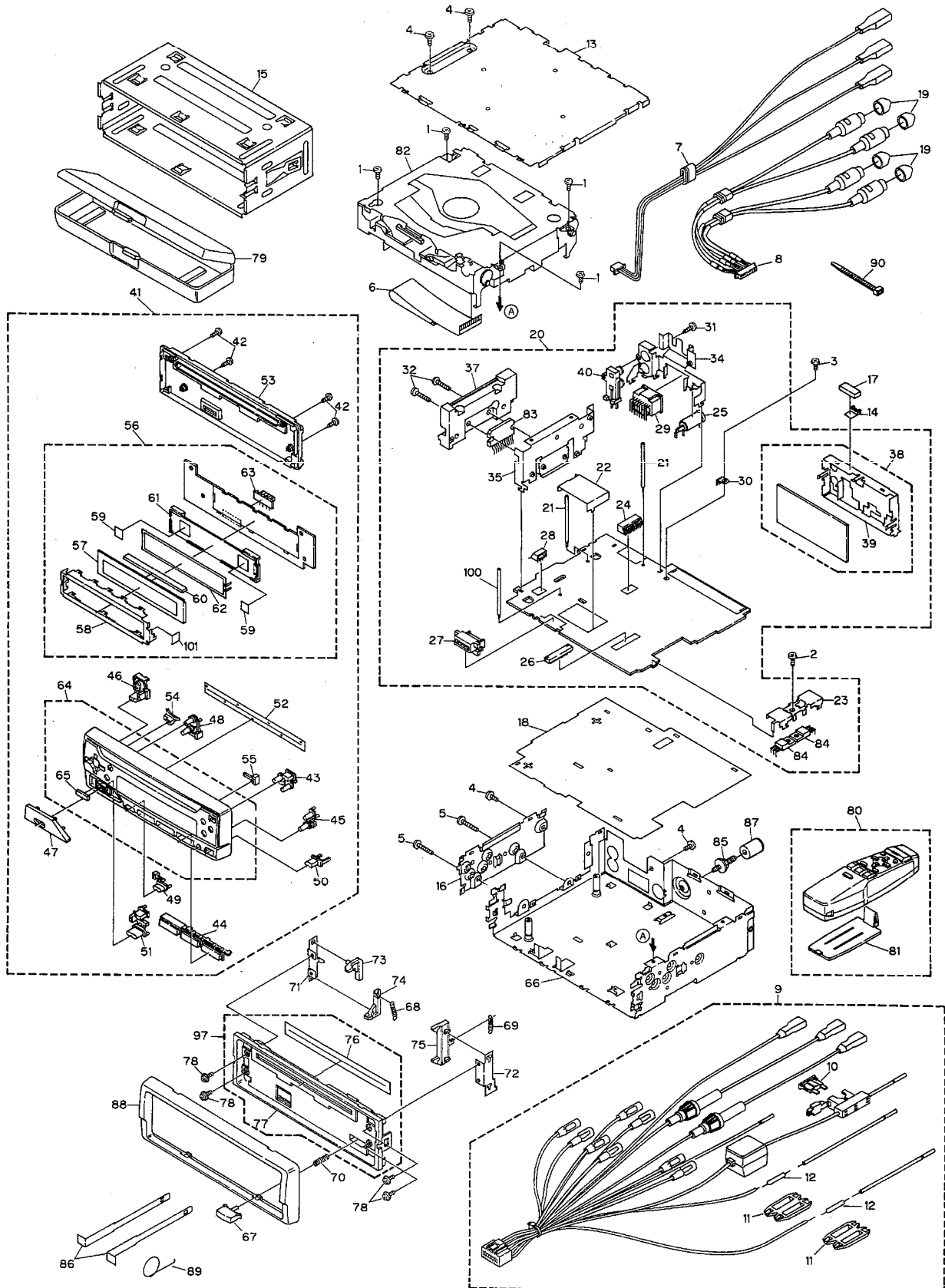

Fig. 3

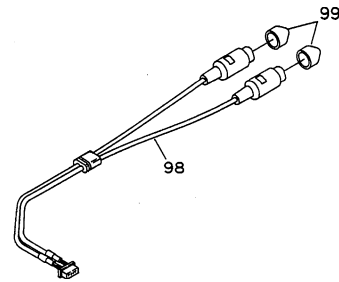
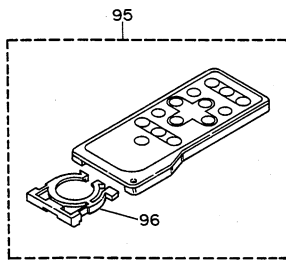
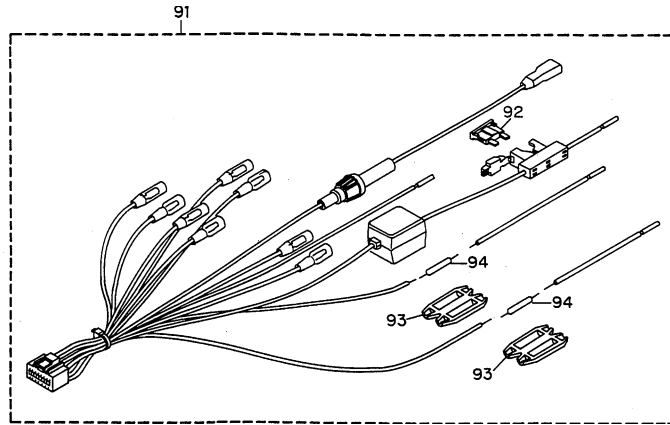

Fig. 4

DEH-68,635,58,535,53

(1)PARTS LIST

Mark No.	Description	Part No.	Mark No.	Description	Part No.
1	Screw	BSZ26P050FMC	51	Button(SOURCE)	CAC5021
2	Screw	ASZ26P080FMC	52	Cover	CNM4704
3	Screw	BSZ30P055FUC	53	Cover	CNS4208
4	Screw	BSZ30P060FMC	54	Lighting Conductor	CNV4799
5	Screw	BSZ30P180FMC	55	Lighting Conductor	CNV4800
6	Cable	CDE4869	56	Keyboard Unit	See Contrast table(2)
7	Cord Assy	See Contrast table(2)	57	LCD	CAW1393
8	Cord Assy	See Contrast table(2)	58	Holder	CNC6864
9	Cord Assy	See Contrast table(2)	59	Film	CNM4349
10	Fuse	See Contrast table(2)	60	Connector	CNV4770
11	Cap	See Contrast table(2)	61	Housing	CNV4797
12	Resistor	See Contrast table(2)	62	EL(IL1801)	CEL1489
13	Case	CNB2119	63	Connector(CN1801)	CKS3580
14	Holder	CNC6469	64	Grille Unit	See Contrast table(2)
15	Holder	CNC6798	65	Cushion	CNM5156
16	Holder	CNC6862	66	Chassis Unit	See Contrast table(2)
17	Cushion	CNM4870	67	Button	CAC5180
18	Insulator	CNM5053	68	Spring	CBH1834
19	Cap	See Contrast table(2)	69	Spring	CBH1835
20	Tuner Amp Unit	See Contrast table(2)	70	Spring	CBH1996
21	Clamper	See Contrast table(2)	71	Bracket	CNC6135
22	Holder	CNC5968	72	Bracket	CNC6791
23	Holder	CNC6132	73	Arm	CNV4692
24	Connector(CN251)	See Contrast table(2)	74	Arm	CNV4693
25	Antenna Jack(CN502)	CKX1056	75	Arm	CNV4951
26	Connector(CN651)	CKS2228	76	Cover	CNM4875
27	Connector(CN801)	CKS3581	77	Panel	See Contrast table(2)
28	Connector(CN851)	See Contrast table(2)	78	Screw	IMS20P030FZK
29	Plug(CN901)	CKM1187	79	Case Assy	CXB1063
30	Wrapping Terminal(CN501)	CKF1059	80	Remote Control Assy	See Contrast table(2)
31	Screw	BPZ26P080FMC	81	Battery Cover	See Contrast table(2)
32	Screw	BSZ26P140FMC	82	CD Mechanism Module	CXK5001
33		83	IC(IC201)	TDA7386
34	Holder	See Contrast table(2)	84	Transistor(Q951, 971)	2SD2396
35	Holder	CNC7006	85	Screw	CBA1284
36		86	Handle	CNC5395
37	Heat Sink	CNR1434	87	Bush	CNV1009
38	FM/AM Tuner Unit	CWE1417	88	Panel	CNS4200
39	Holder	CNC6555	89	Spring	CBH-865
40	Pin Jack(CN253)	CKB1028	* 90	Lock Tie	See Contrast table(2)
41	Detach Grille Assy	See Contrast table(2)	91	Cord Assy	See Contrast table(2)
42	Screw	BPZ20P100FZK	92	Fuse	See Contrast table(2)
43	Button(EJECT)	CAC4875	93	Cap	See Contrast table(2)
44	Button(1-6)	CAC4876	94	Resistor	See Contrast table(2)
45	Button(PGM)	See Contrast table(2)	95	Remote Control Unit	See Contrast table(2)
46	Button(∧, <)	CAC4878	96	Cover	See Contrast table(2)
47	Button(VOLUME)	CAC4879	97	Panel Unit	See Contrast table(2)
48	Button(A, F)	CAC4880	98	Cord Assy	See Contrast table(2)
49	Button(BAND)	CAC4881	99	Cap	See Contrast table(2)
50	Button(DETACH)	CAC4883	100	Clamper	See Contrast table(2)
			* 101	Spacer	CNM5379

(2) CONTRAST TABLE

DEH-68/UC, DEH-635/UC, DEH-58/UC, DEH-535/UC and DEH-53/UC have the same construction except for the following:

Mark No.	Symbol & Description	Part No.				
		DEH-68/UC	DEH-635/UC	DEH-58/UC	DEH-535/UC	DEH-53/UC
7	Cord Assy	CDE5184	Not used	CDE5184	Not used	Not used
8	Cord Assy	CDE5210	Not used	CDE5210	Not used	Not used
9	Cord Assy	CDE5186	CDE5186	CDE5186	Not used	Not used
10	Fuse(10A)	CEK1136	CEK1136	CEK1136	Not used	Not used
11	Cap	CNS1472	CNS1472	CNS1472	Not used	Not used
12	Resistor	RS1/2P102JL	RS1/2P102JL	RS1/2P102JL	Not used	Not used
19	Cap	CNV2680	Not used	CNV2680	Not used	Not used
20	Tuner Amp Unit	CWM5002	CWM5003	CWM5006	CWM5007	CWM5008
21	Clamper	CEF1009	CEF1009	CEF1009	CEF1009	Not used
24	Connector	CKS3602(CN251)	CKS3598(CN255)	CKS3602(CN251)	CKS3598(CN255)	Not used
28	Connector(CN851)	CKS3597	Not used	CKS3597	Not used	Not used
34	Holder	CNC6887	CNC6886	CNC6887	CNC6886	CNC6888
41	Detach Grille Assy	CXA9612	CXA9613	CXA9616	CXA9617	CXA9618
45	Button	CAC4877	CAC4877	CAC5079	CAC5079	CAC5079
56	Keyboard Unit	CWM5012	CWM5013	CWM5016	CWM5017	CWM5018
64	Grille Unit	CXA9700	CXA9760	CXA9765	CXA9762	CXA9764
66	Chassis Unit	CXA9659	CXA9662	CXA9659	CXA9662	CXA9662
77	Panel	CNS4451	CNS4451	CNS4450	CNS4209	CNS4209
80	Remote Control Assy	CXB1160	CXB1160	Not used	Not used	Not used
81	Battery Cover	CNS4406	CNS4406	Not used	Not used	Not used
*	90 Lock Tie	CNV-754	Not used	CNV-754	Not used	Not used
	91 Cord Assy	Not used	Not used	Not used	CDE5324	CDE5324
	92 Fuse(10A)	Not used	Not used	Not used	CEK1136	CEK1136
	93 Cap	Not used	Not used	Not used	CNS1472	CNS1472
	94 Resistor	Not used	Not used	Not used	RS1/2P102JL	RS1/2P102JL
	95 Remote Control Unit	Not used	Not used	CXB1225	CXB1225	CXB1225
	96 Cover	Not used	Not used	CNS4139	CNS4139	CNS4139
	97 Panel Unit	Not used	Not used	CXB1284	CXB1401	CXB1401
	98 Cord Assy	Not used	CDE5208	Not used	CDE5208	Not used
	99 Cap	Not used	CNV2680	Not used	CNV2680	Not used
100	Clamper	CEF1009	Not used	CEF1009	Not used	Not used

2.3 CD MECHANISM MODULE

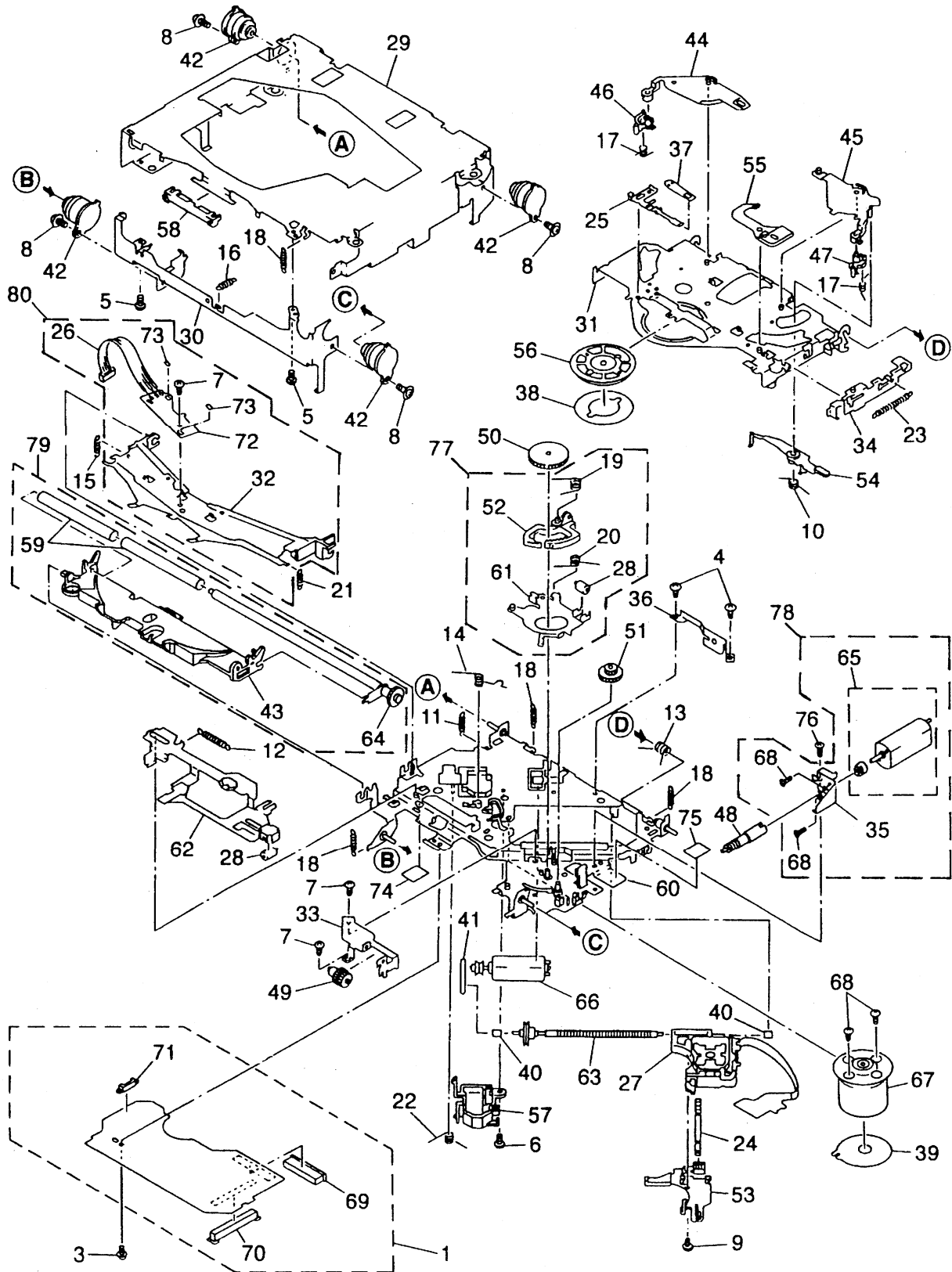

Fig. 5

● Parts List

Mark No.	Description	Part No.	Mark No.	Description	Part No.
1	Control Unit	CWX1889	46	Arm	CNV4124
2		47	Arm	CNV4125
3	Screw	IMS26P035FMC	48	Gear	CNV4128
4	Screw	BMZ20P040FMC	49	Gear	CNV4129
5	Screw	BSZ20P040FMC	50	Gear	CNV4130
6	Screw(M2×3)	CBA1077	51	Gear	CNV4131
7	Screw(M2×2)	CBA1250	52	Arm	CNV4136
8	Screw(M2×5)	CBA1296	53	Holder	CNV4663
9	Screw(M2×3.85)	CBA1362	54	Arm	CNV4138
10	Spring	CBH1945	55	Arm	CNV4139
11	Spring	CBH1724	56	Clamper	CNV4140
12	Spring	CBH1939	57	Holder	CNV4664
13	Spring	CBH1729	58	Guide	CNV4484
14	Spring	CBH1730	59	Roller	CNV4509
15	Spring	CBH1731	60	Chassis Unit	CXA9515
16	Spring	CBH1732	61	Arm Unit	CXA8565
17	Spring	CBH1736	62	Lever Unit	CXA9300
18	Spring	CBH1745	63	Screw Unit	CXA8699
19	Spring	CBH1832	64	Gear Unit	CXA8701
20	Spring	CBH1833	65	Load Motor Unit(M3)	CXA8702
21	Spring	CBH1848	66	CRG Motor Unit(M2)	CXA8986
22	Spring	CBH1849	67	Motor Unit(M1)	CXA8912
23	Spring	CBH1863	68	Screw	JFZ20P025FMC
24	Spring	CBL1214	69	Connector(CN101)	CKS1953
25	Spring	CBL1269	70	Connector(CN701)	CKS2774
26	Connector(CN1)	CDE4576	71	Connector(CN801)	CKS2196
27	Pickup Unit(Service)	CXX1230	* 72	Gathering PCB	CNX2445
28	Roller	CLA2627	73	Photo-transistor(Q1, 2)	CPT-230S-X
29	Frame	CNC5796	74	Sheet	CNM4873
30	Frame	CNC5797	75	Cushion	CNM3917
31	Arm	CNC5799	76	Screw	BMZ20P025FMC
32	Arm	CNC5801	77	ELBO Arm Assy	CXA8889
33	Bracket	CNC5871	78	Load Motor Assy	CXA8891
34	Lever	CNC6054	79	LO Arm Assy	CXA8892
35	Bracket	CNC6056	80	Guide Arm Assy	CXA8893
* 36	Bracket	CNC6376			
37	Spacer	CNM3315			
38	Sheet	CNM4849			
39	PCB	CNP4230			
40	Bearing	CNR1415			
41	Belt	CNT1071			
42	Damper	CNV3974			
43	Arm	CNV4120			
44	Arm	CNV4122			
45	Arm	CNV4123			

3. SCHEMATIC DIAGRAM

3.1 OVERALL CONNECTION DIAGRAM(GUIDE PAGE)

(DEH-68/UC, 635/UC, 58/UC)

Note: When ordering service parts, be sure to refer to "EXPLODED VIEWS AND PARTS LIST" or "ELECTRICAL PARTS LIST".

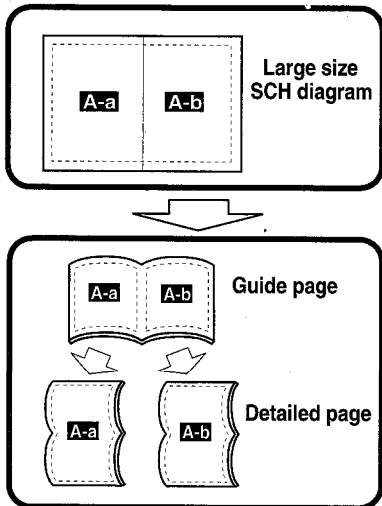

A-a

NOTE
 □ Symbol indicates a resistor.
 No differentiation is made between chip resistors and discrete resistors.
 □ Symbol indicates a capacitor.
 No differentiation is made between chip capacitors and discrete capacitors.
 The Δ mark found on some component parts indicates the importance of the safety factor of the part. Therefore, when replacing, be sure to use parts of identical designation.
 Decimal points for resistor and capacitor fixed values are expressed as:
 2.2=2R2
 0.022=0022

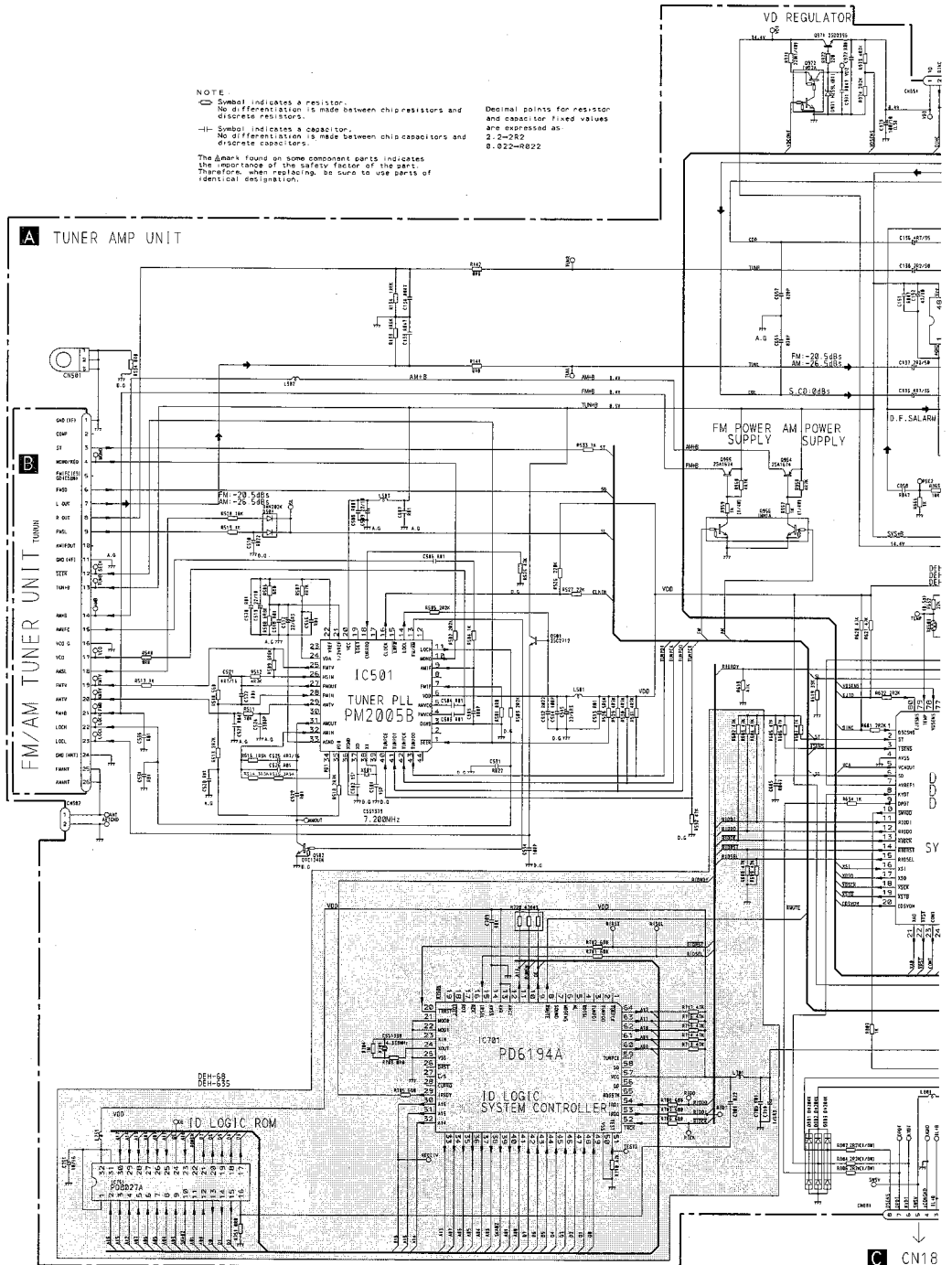

A-b

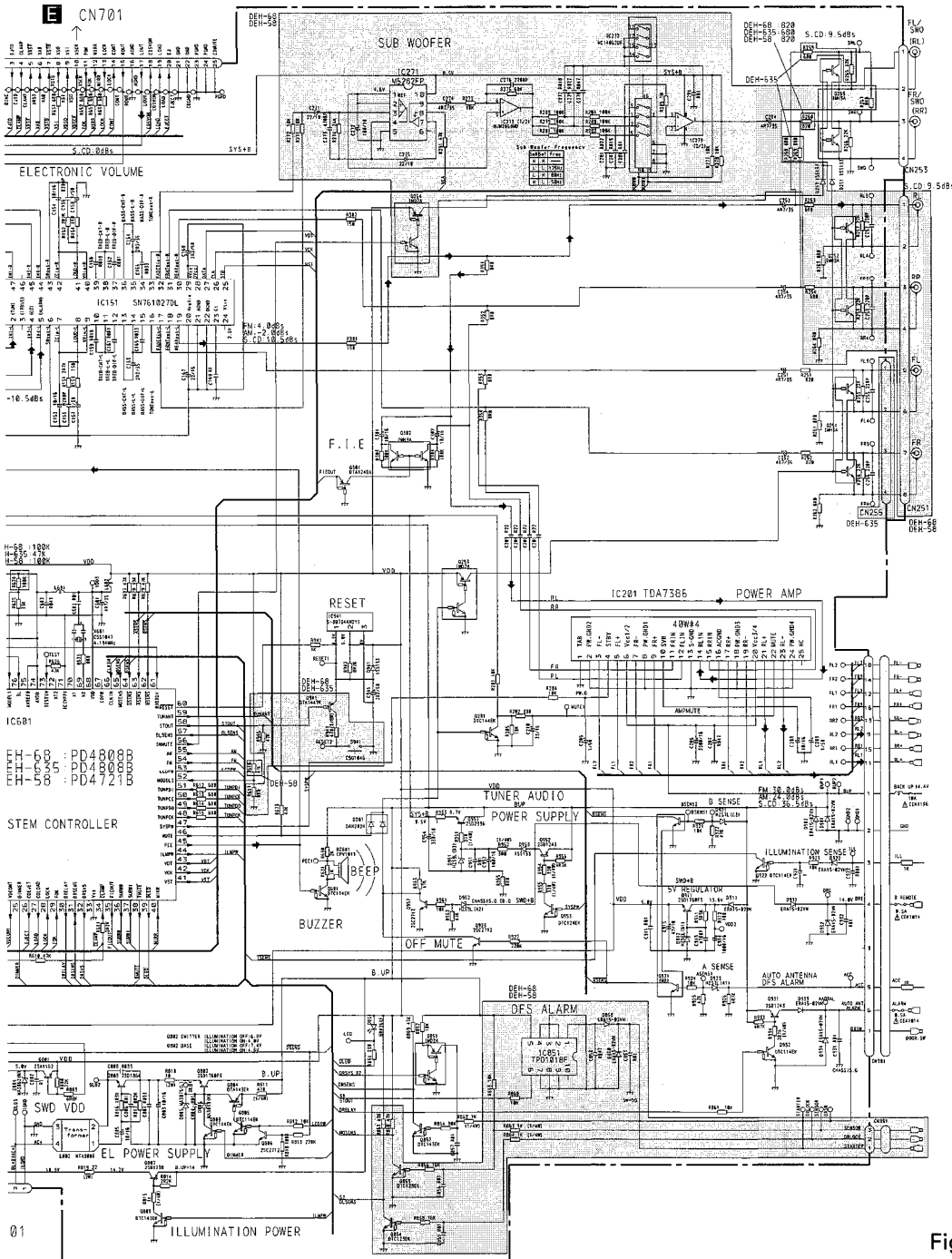
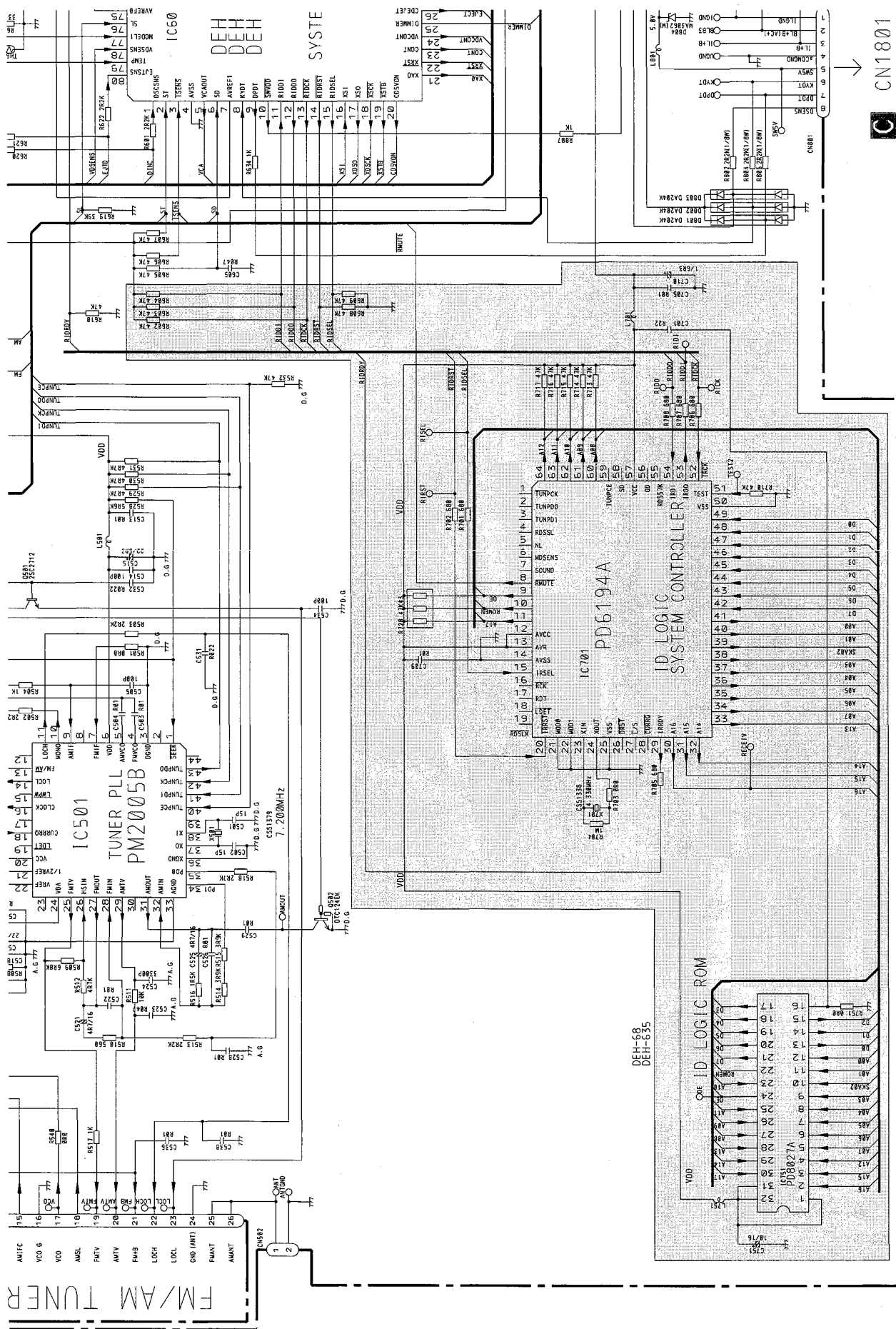

Fig. 6



A-a A-b

Fig. 7

DEH-68,635,58,535,53

A-a A-b

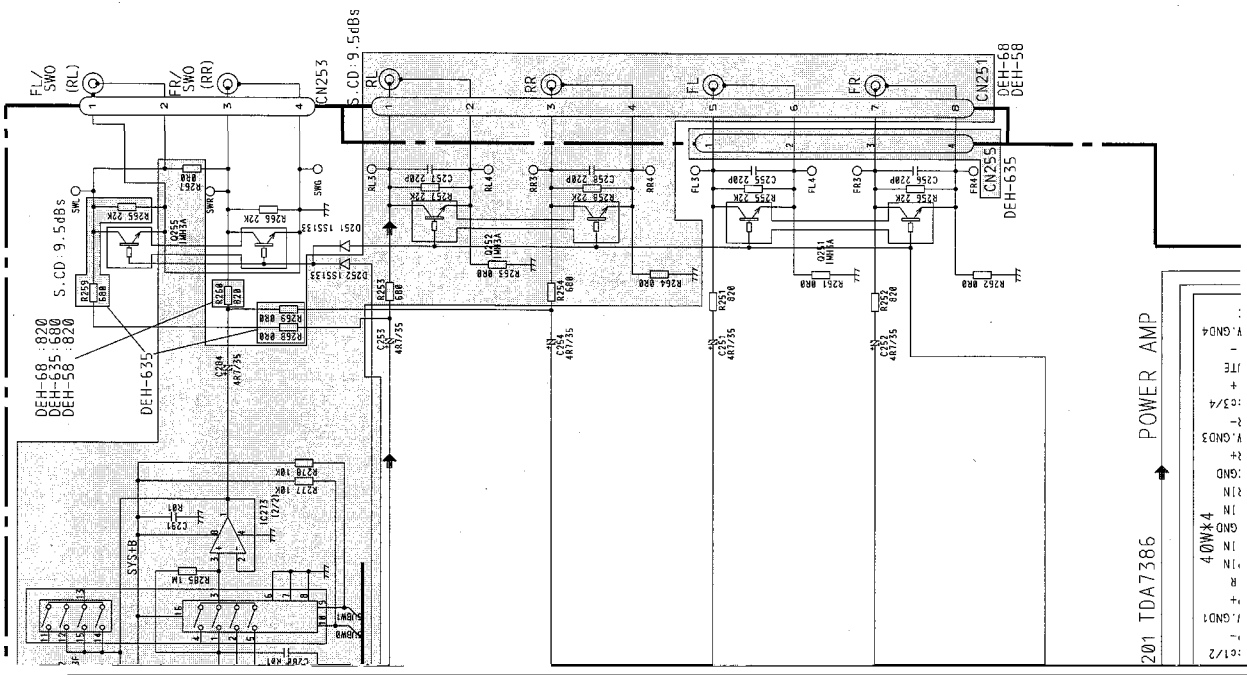

A-a A-b

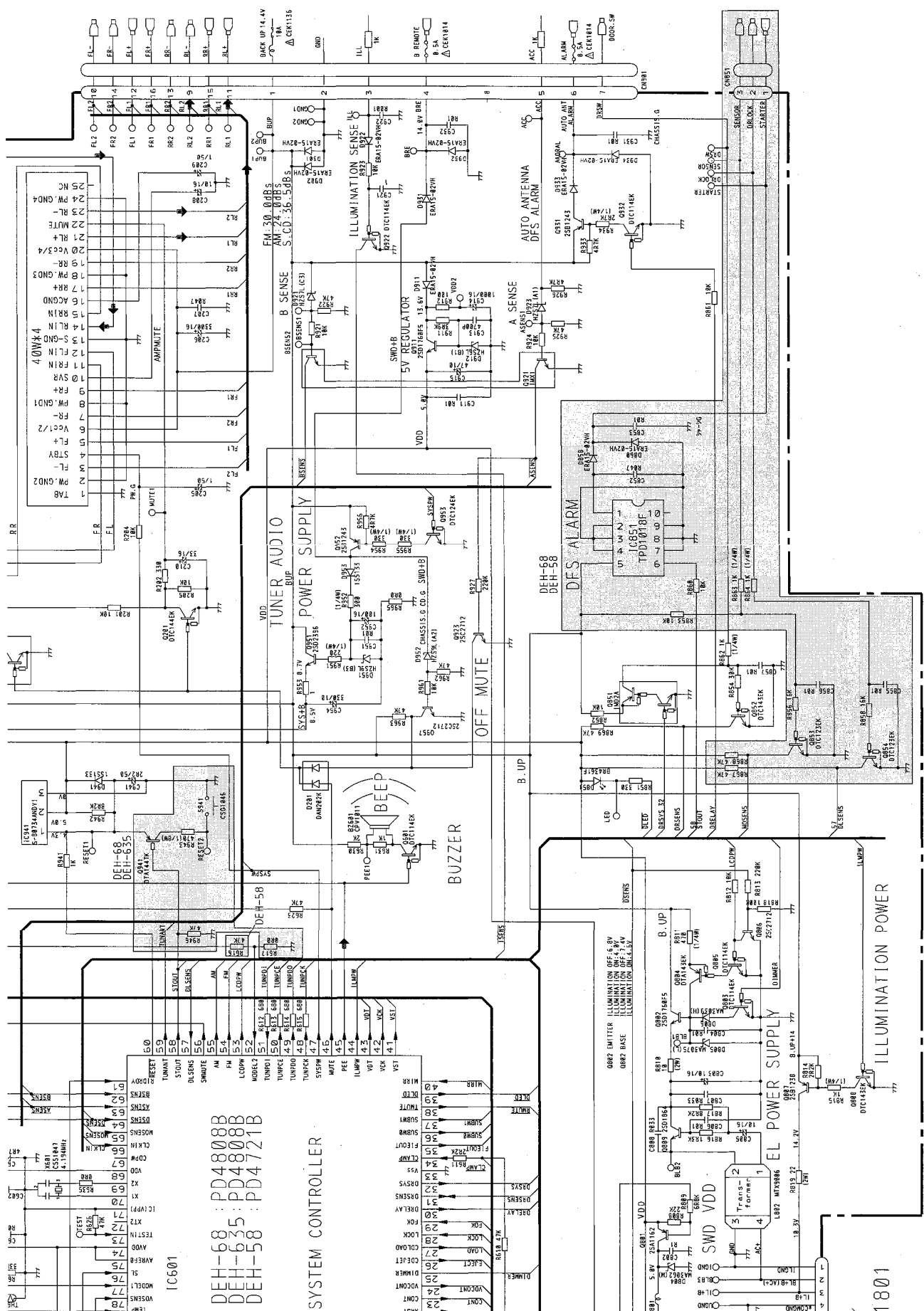

DEH-68 : PD48008B
 DEH-635 : PD48008B
 DEH-58 : PD4721B

SYSTEM CONTROLLER

1801

Fig. 8

A-b

3.2 OVERALL CONNECTION DIAGRAM(GUIDE PAGE)(DEH-535/UC, 53/UC)

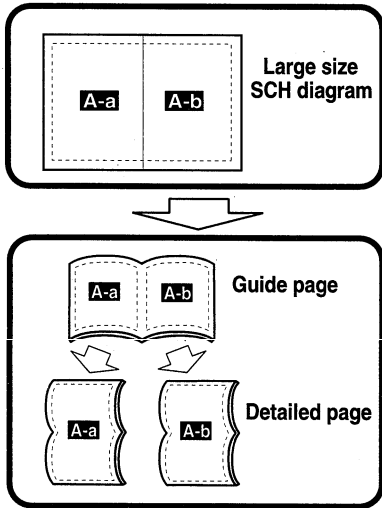

A-a

NOTE:
 □ Symbol indicates a resistor.
 No differentiation is made between chip resistors and discrete resistors.
 -||- Symbol indicates a capacitor.
 No differentiation is made between chip capacitors and discrete capacitors.
 The Δ mark found on some component parts indicates the importance of the safety factor of the parts. Therefore, when replacing, be sure to use parts of identical designation.
 Decimal points for resistor and capacitor fixed values are expressed as:
 2.2-2R2
 0.022-R022

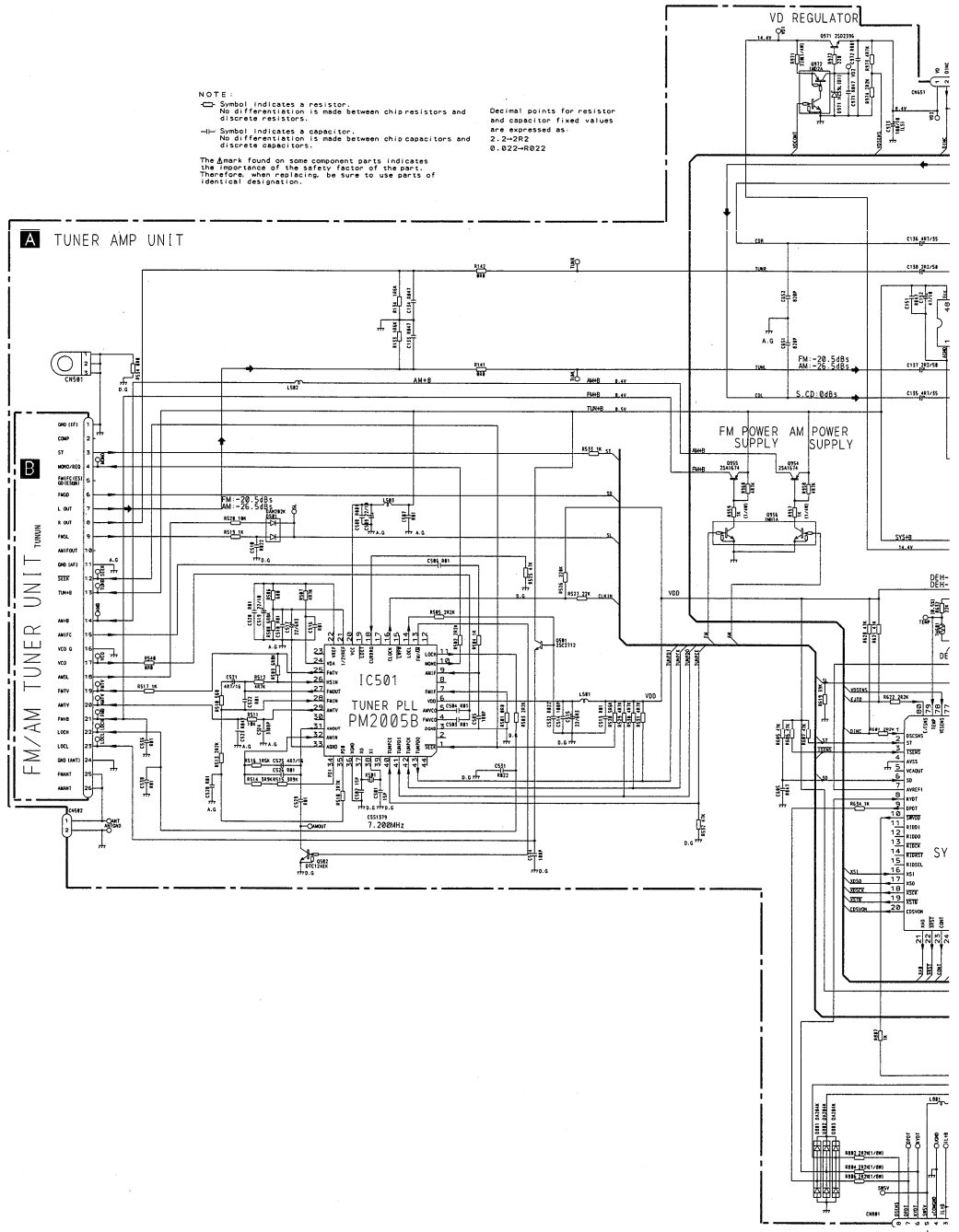

C CN18

A-b

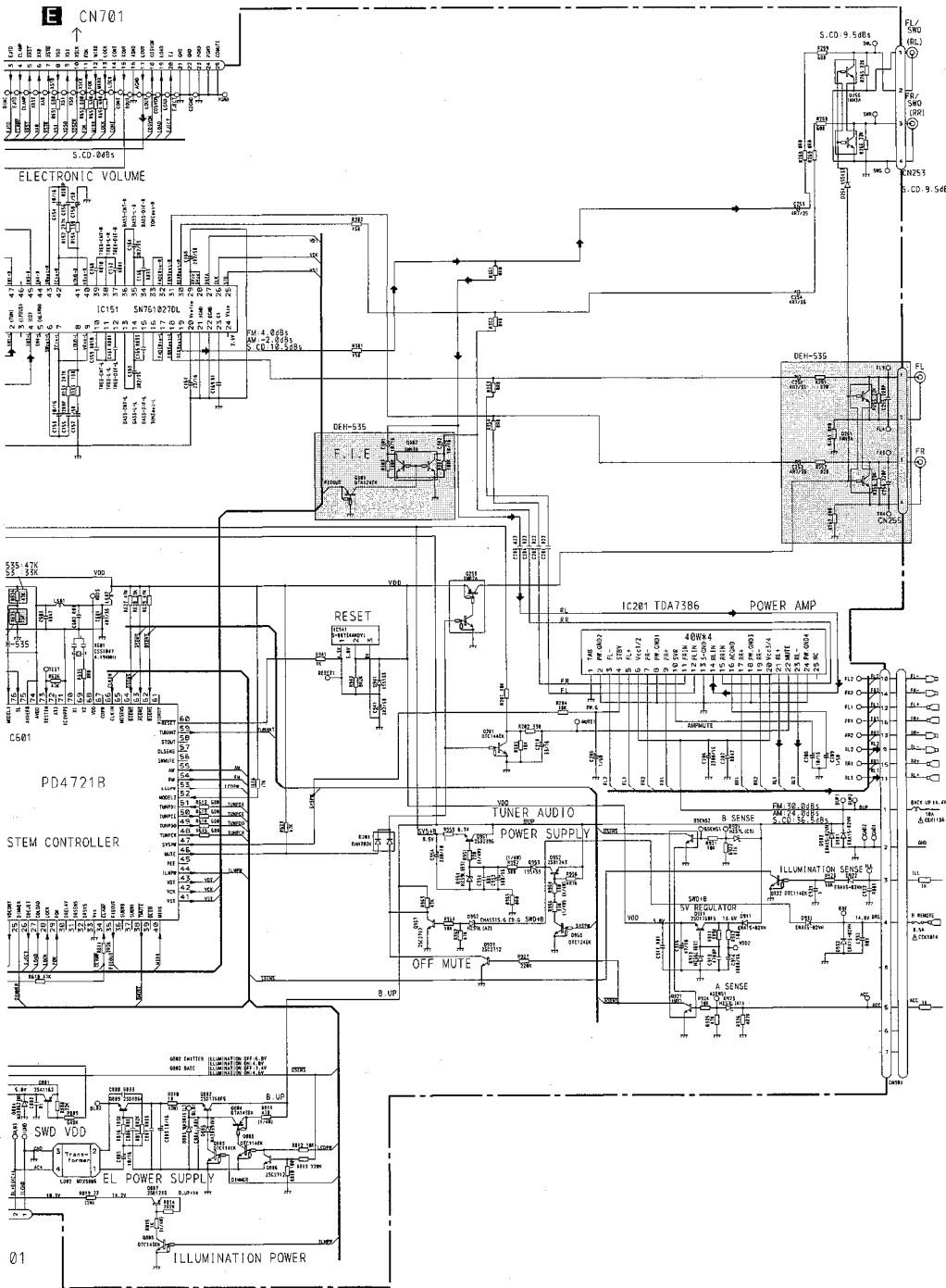
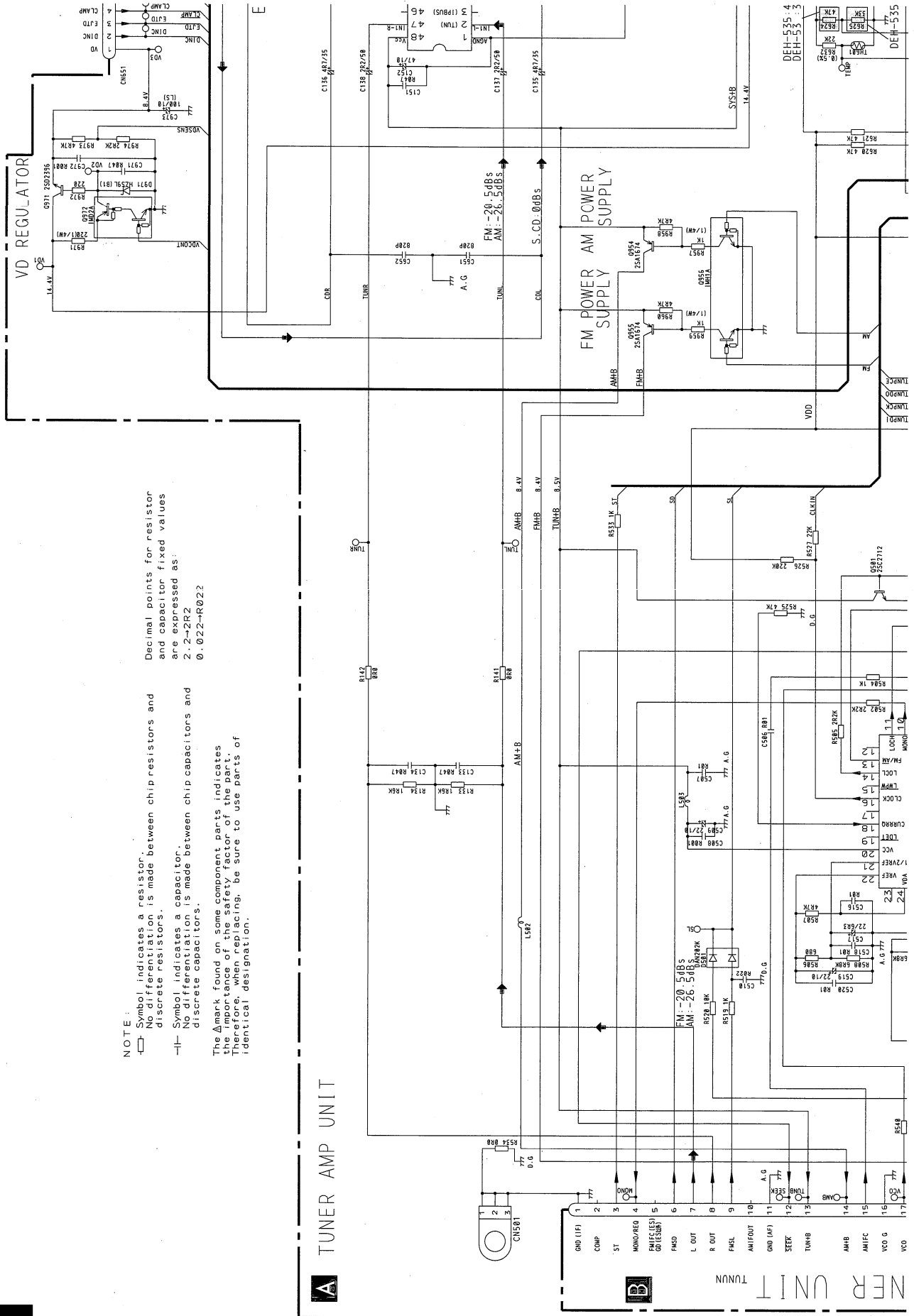

Fig. 9

A-a A-b



NOTE:
 □ Symbol indicates a resistor. No differentiation is made between chip resistors and discrete resistors.
 □ Symbol indicates a capacitor. No differentiation is made between chip capacitors and discrete capacitors.

The Δ mark found on some component parts indicates that the part is a safety factor of the part. Therefore, when replacing, be sure to use parts of identical designation.

TUNER AMP UNIT

TUNER UNIT

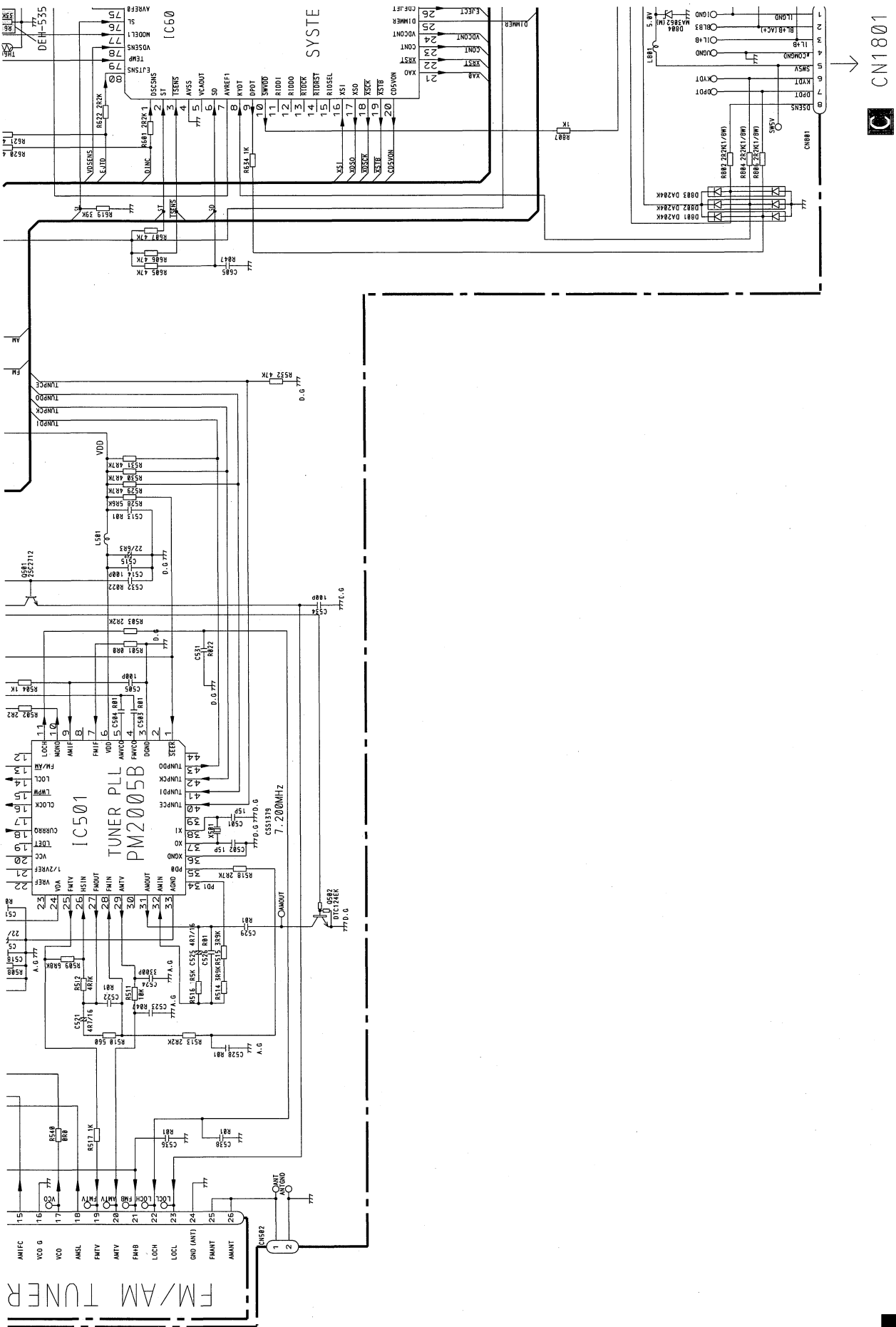

A-a A-b

Fig. 10

DEH-68,635,58,535,53

A-a

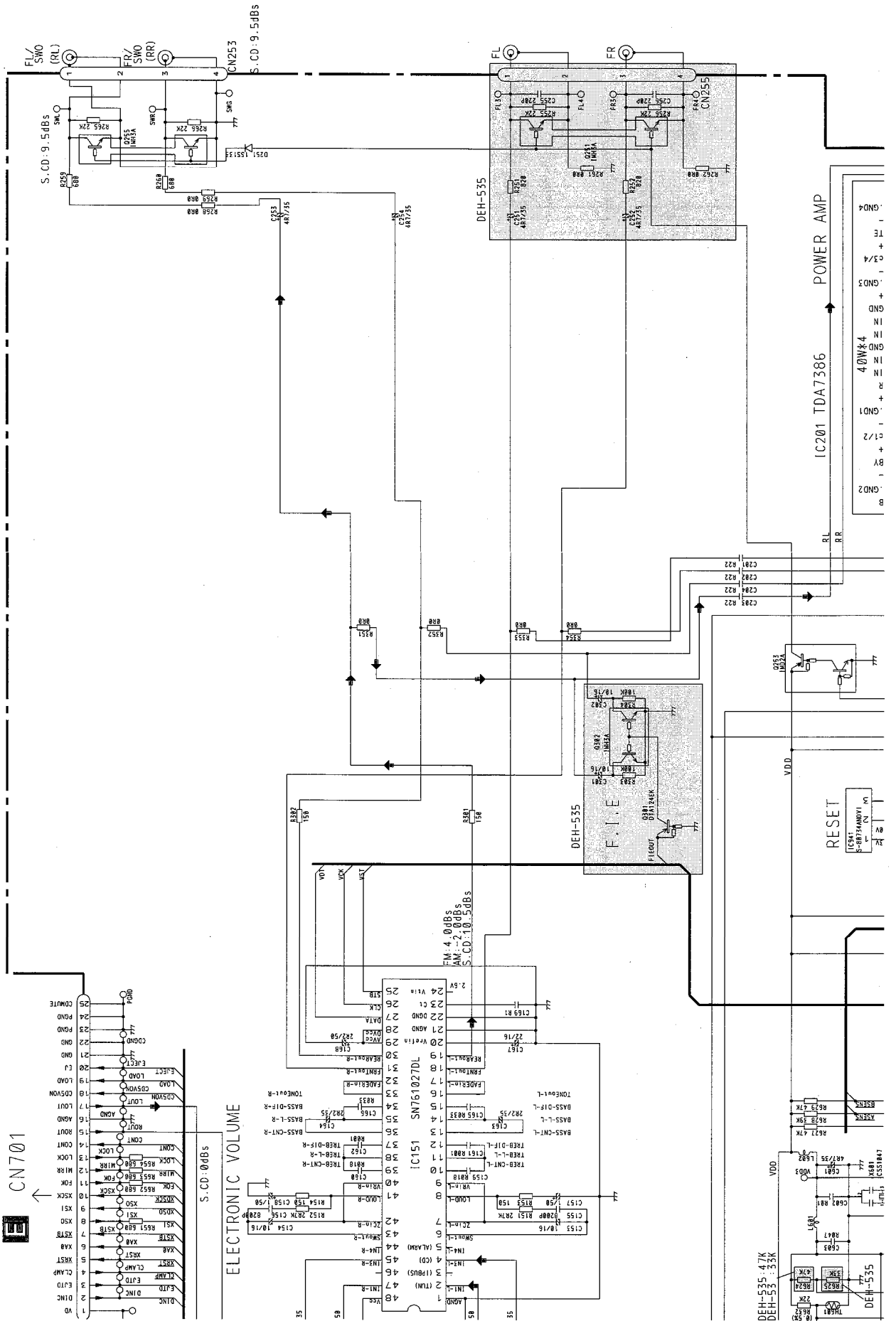

22

A-b

A-a
A-b

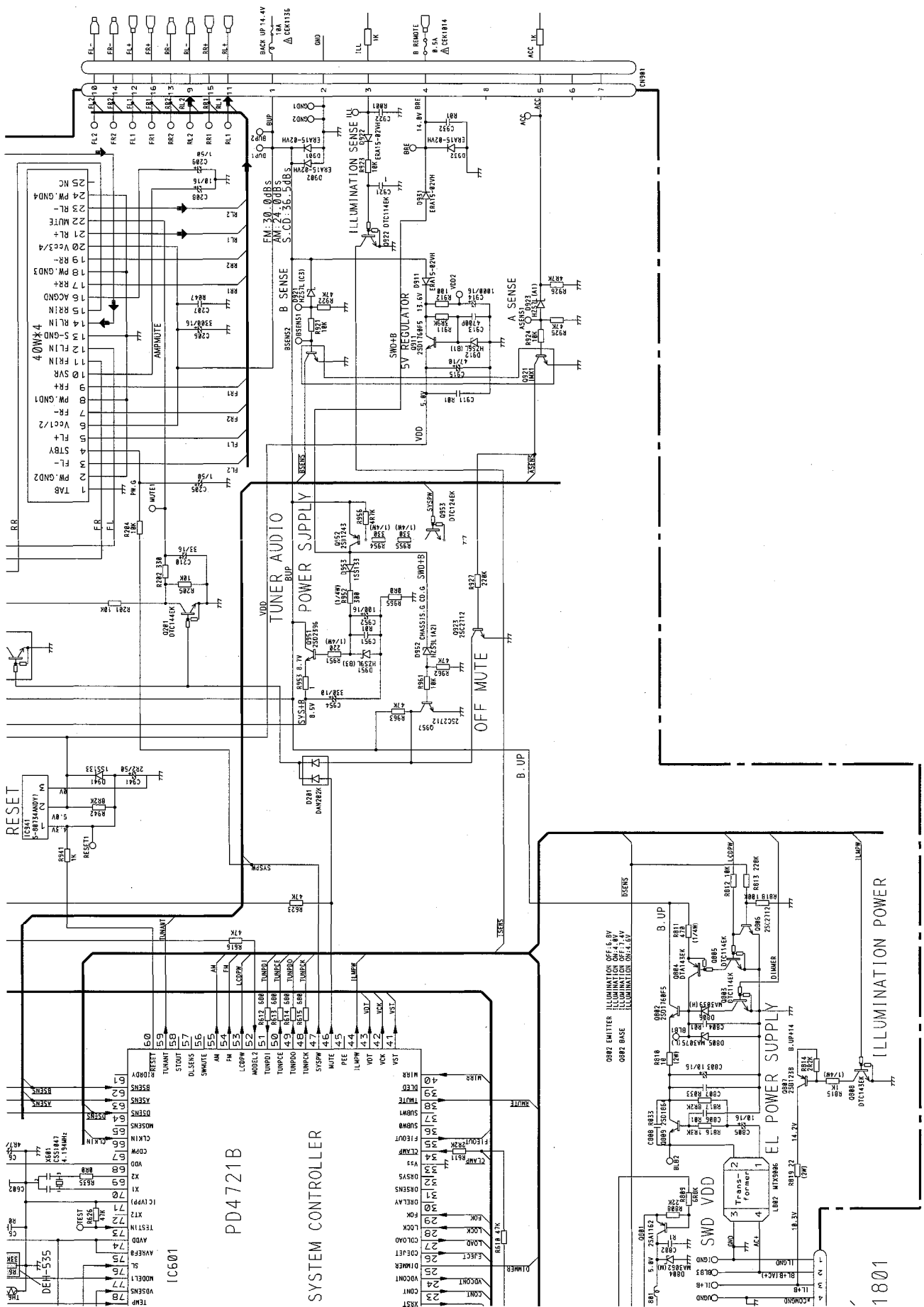
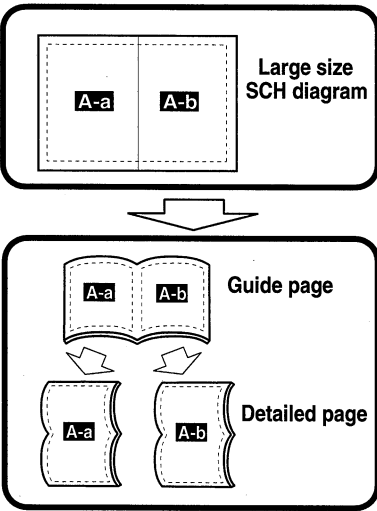

Fig. 11

A-b

3.3 CD MECHANISM MODULE(GUIDE PAGE)



PICKUP UNIT
(SERVICE) (CXX1230)

E CONTROL UNIT

E-a

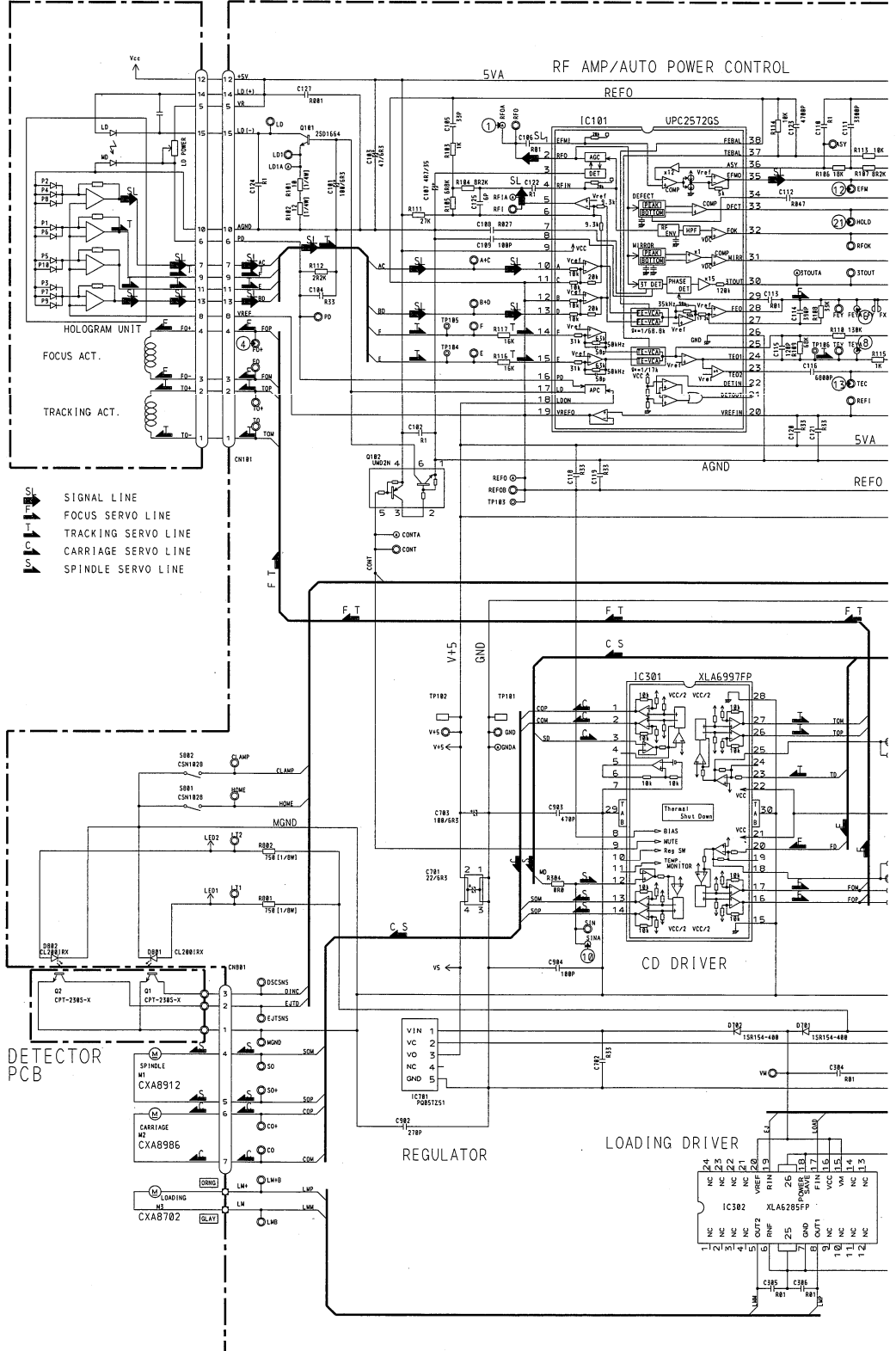

PICKUP UNIT (SERVICE) (CXX1230) E CONTROL UNIT

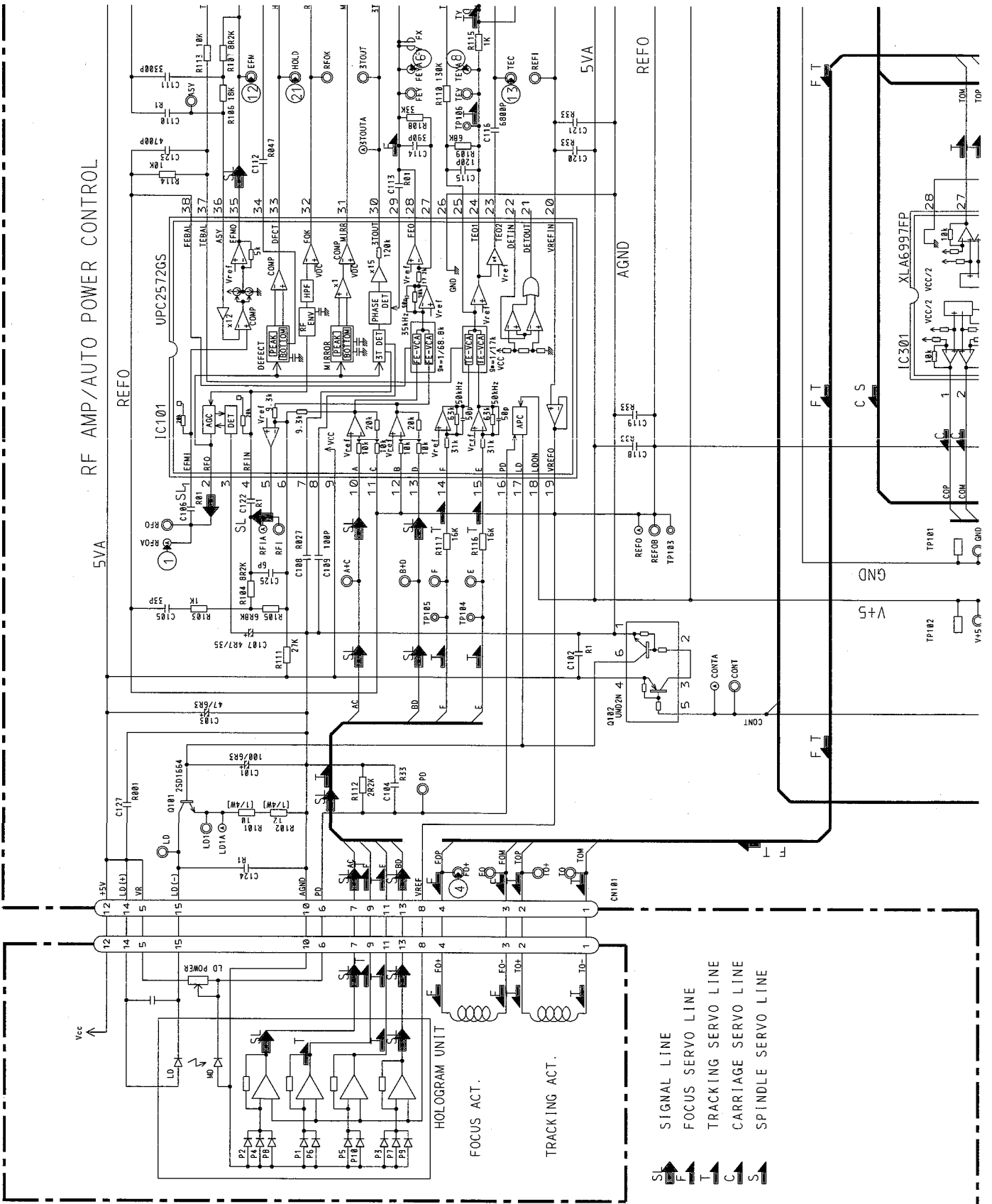

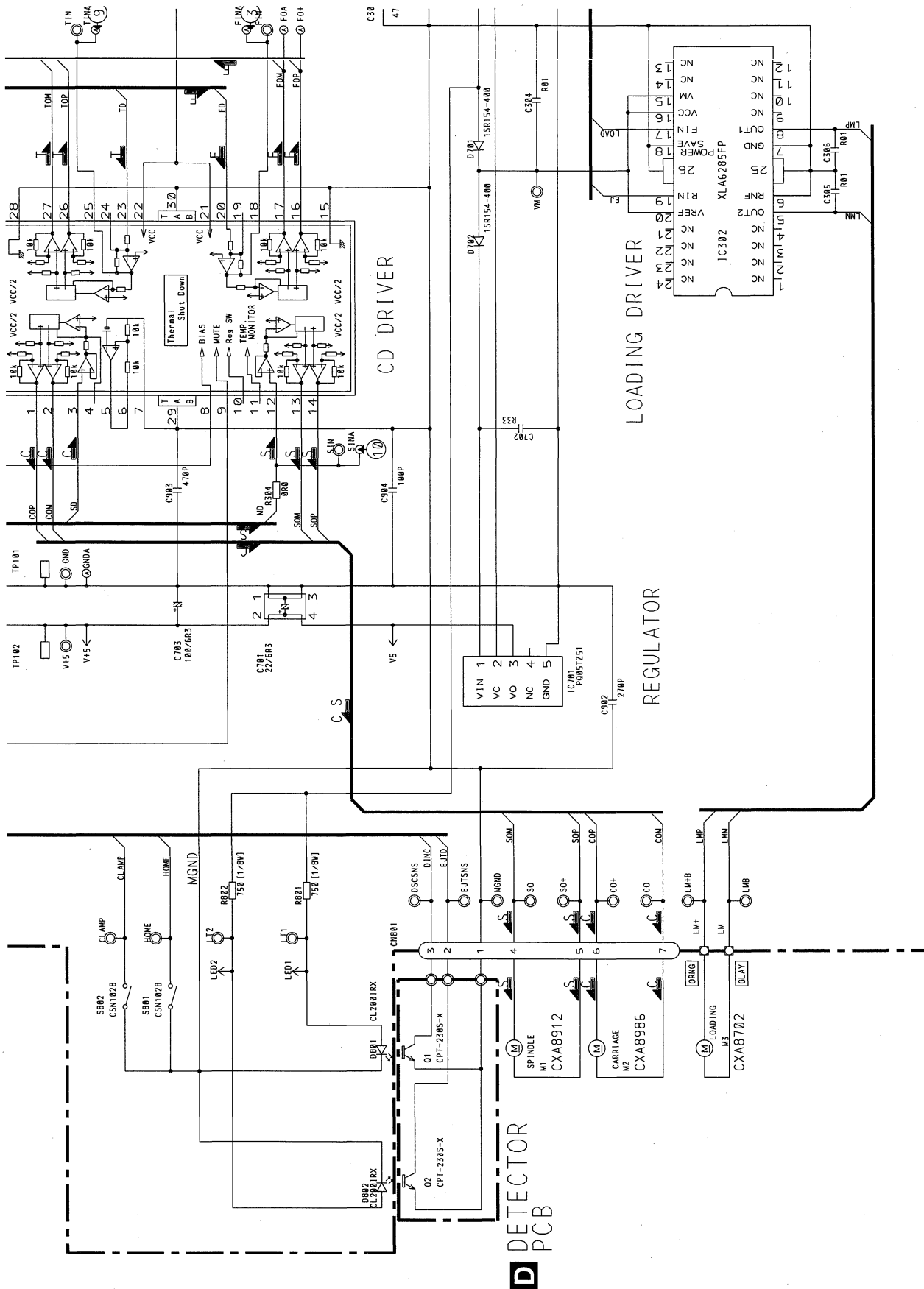

SWITCHES:
 CONTROL UNIT
 S801: HOME SWITCH.....ON-OFF
 S802: CLAMP SWITCH.....ON-OFF
 The underlined indicates the switch position.

E-a E-b

Fig. 13

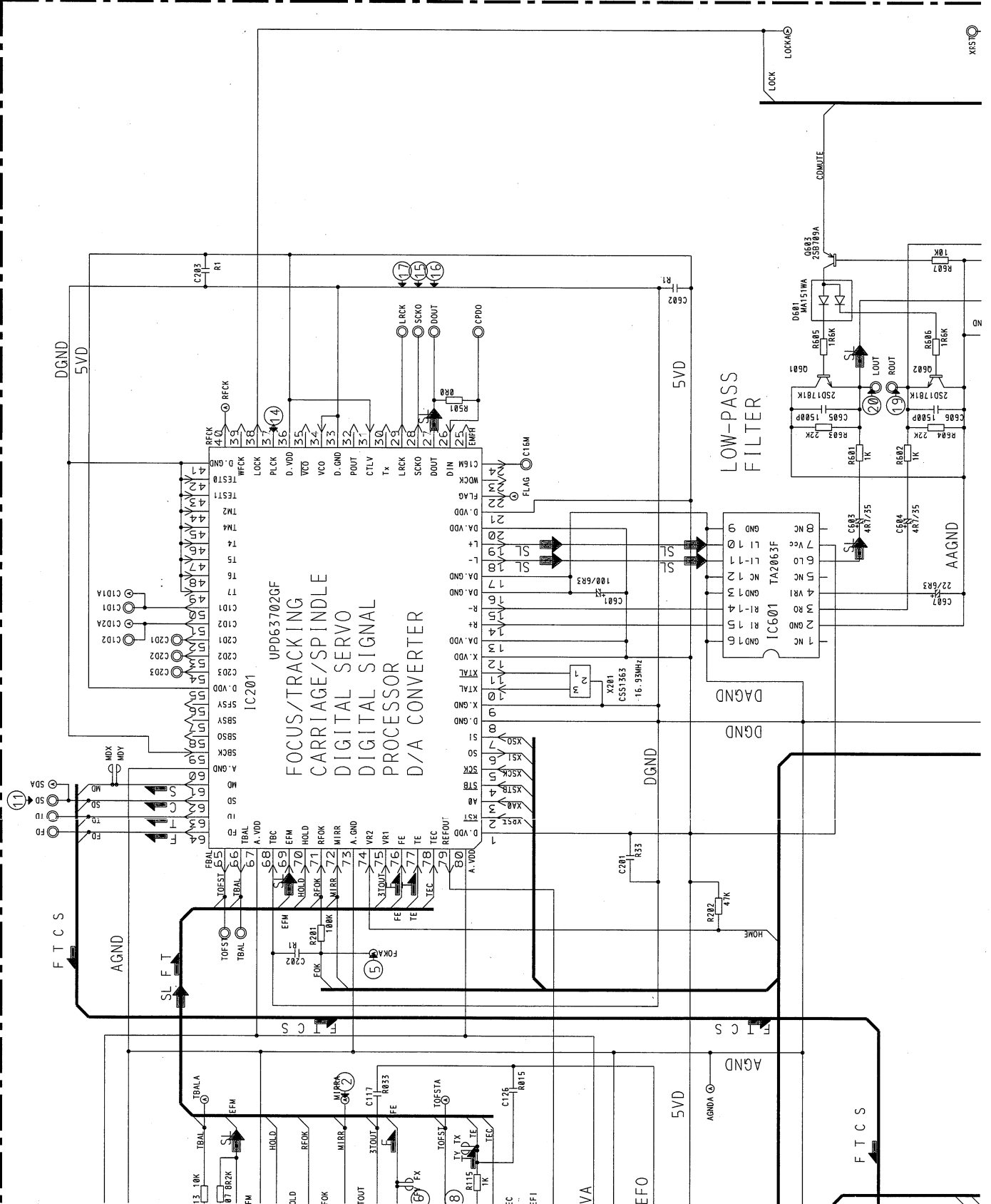

UPD63702GF
 FOCUS/TRACKING
 CARRIAGE/SPINDLE
 DIGITAL SERVO
 DIGITAL SIGNAL
 PROCESSOR
 D/A CONVERTER

LOW-PASS
 FILTER

IC601 TAZ063F

AAGND

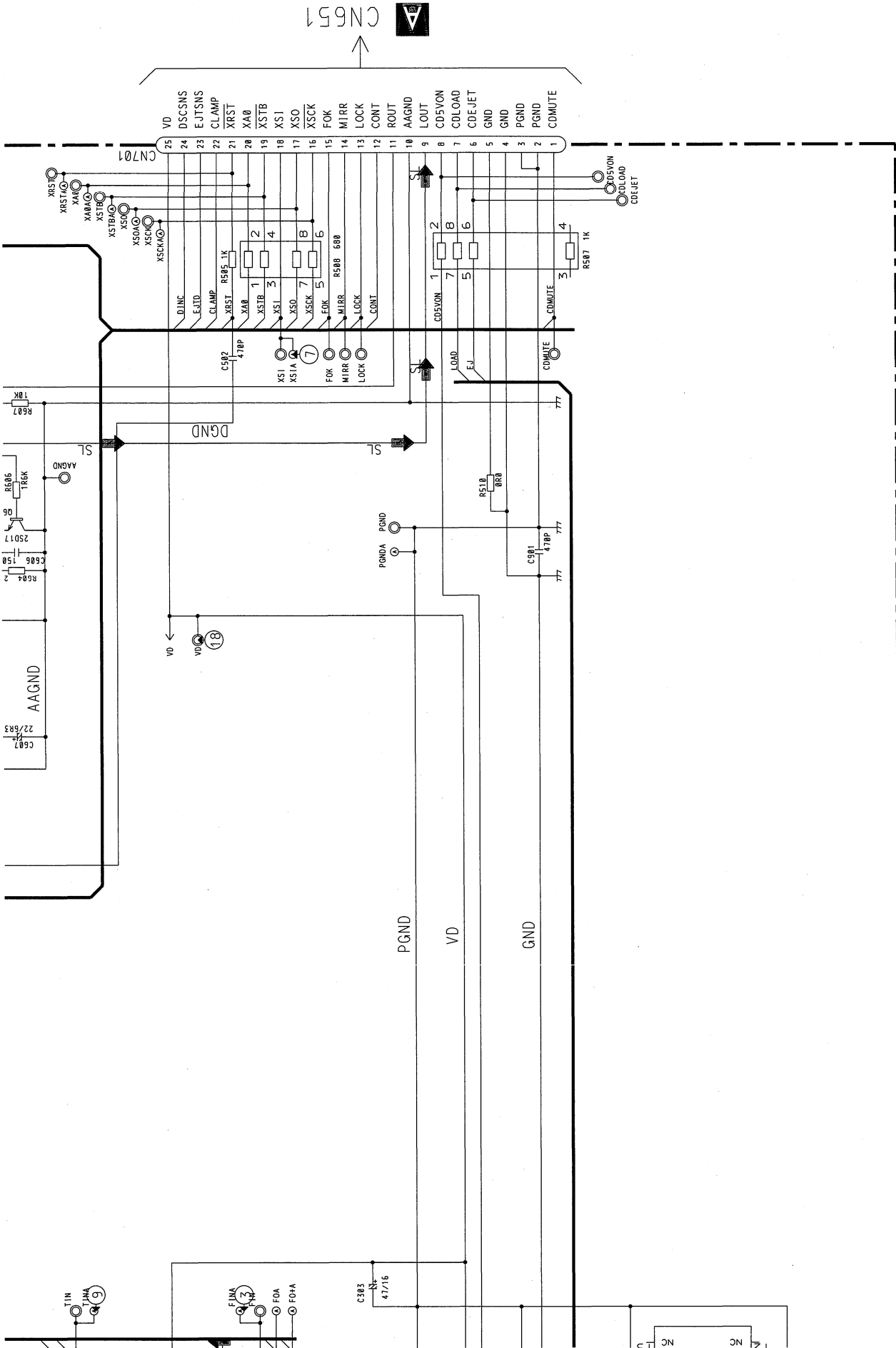
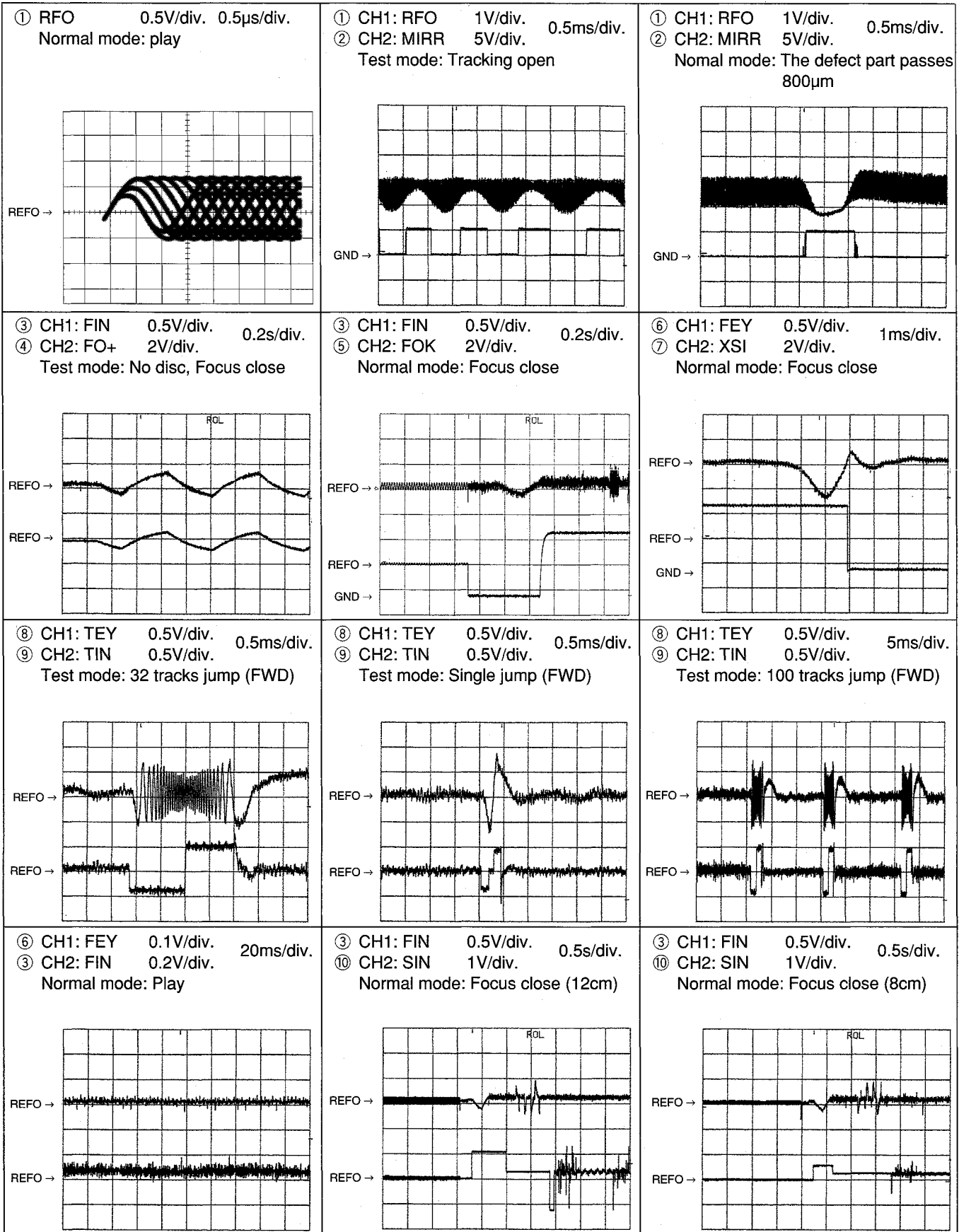
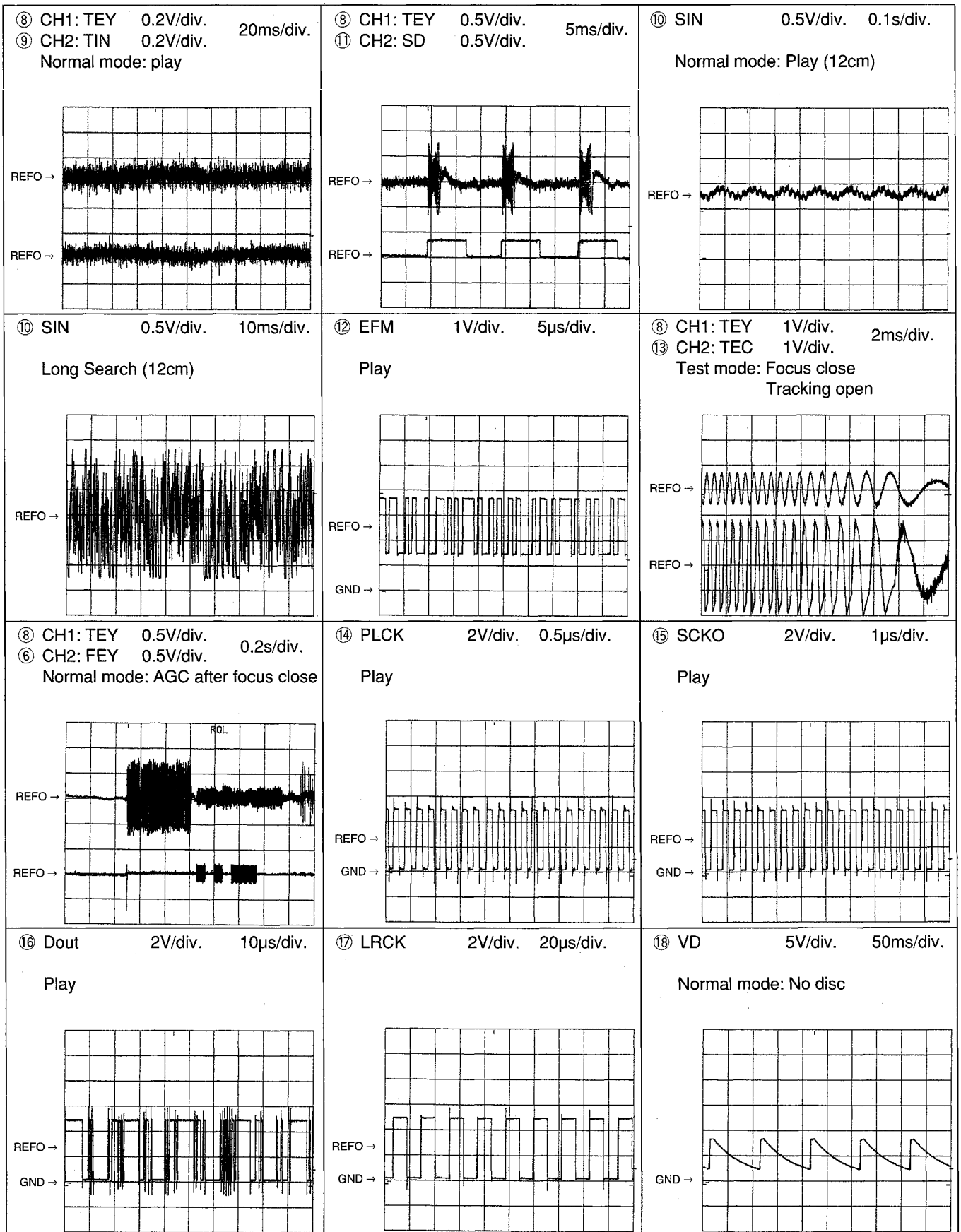

Fig. 14

Note:1. The encircled numbers denote measuring pointes in the circuit diagram.
 2. Reference voltage
 REFO:2.5V

● **Waveforms**





DEH-68,635,58,535,53

⑱ CH1: R OUT 1V/div. 0.2ms/div.
 ⑳ CH2: L OUT 1V/div. 0.2ms/div.
 Normal mode: Play (1kHz 0dB)

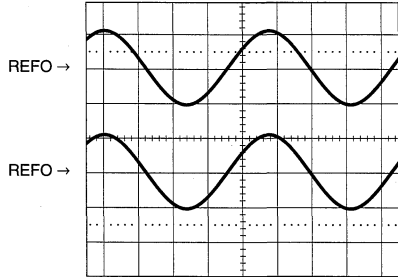

⑥ CH1: FEY 0.2V/div. 1ms/div.
 ③ CH2: FIN 0.5V/div. 1ms/div.
 Normal mode: During AGC

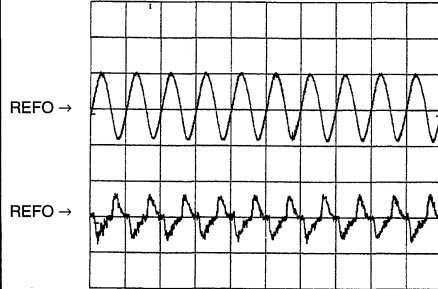

⑧ CH1: TEY 0.2V/div. 1ms/div.
 ⑨ CH2: TIN 0.5V/div. 1ms/div.
 Normal mode: During AGC

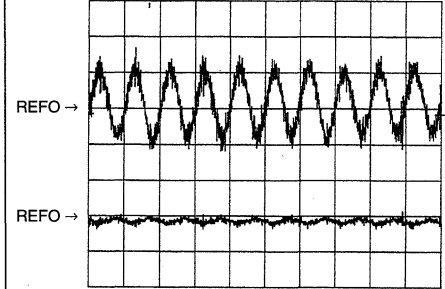

① CH1: RFO 1V/div. 0.5ms/div.
 ② CH2: HOLD 5V/div. 0.5ms/div.
 Normal mode: The defect part passes 800μm

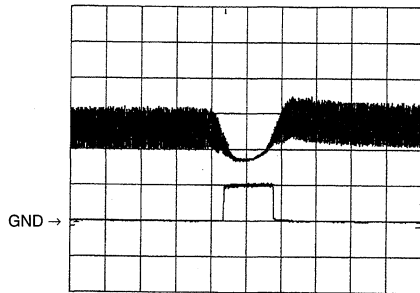

③ CH1: FIN 1V/div. 0.5ms/div.
 ② CH2: HOLD 5V/div. 0.5ms/div.
 Normal mode: The defect part passes 800μm

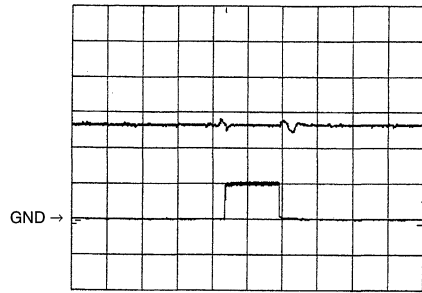

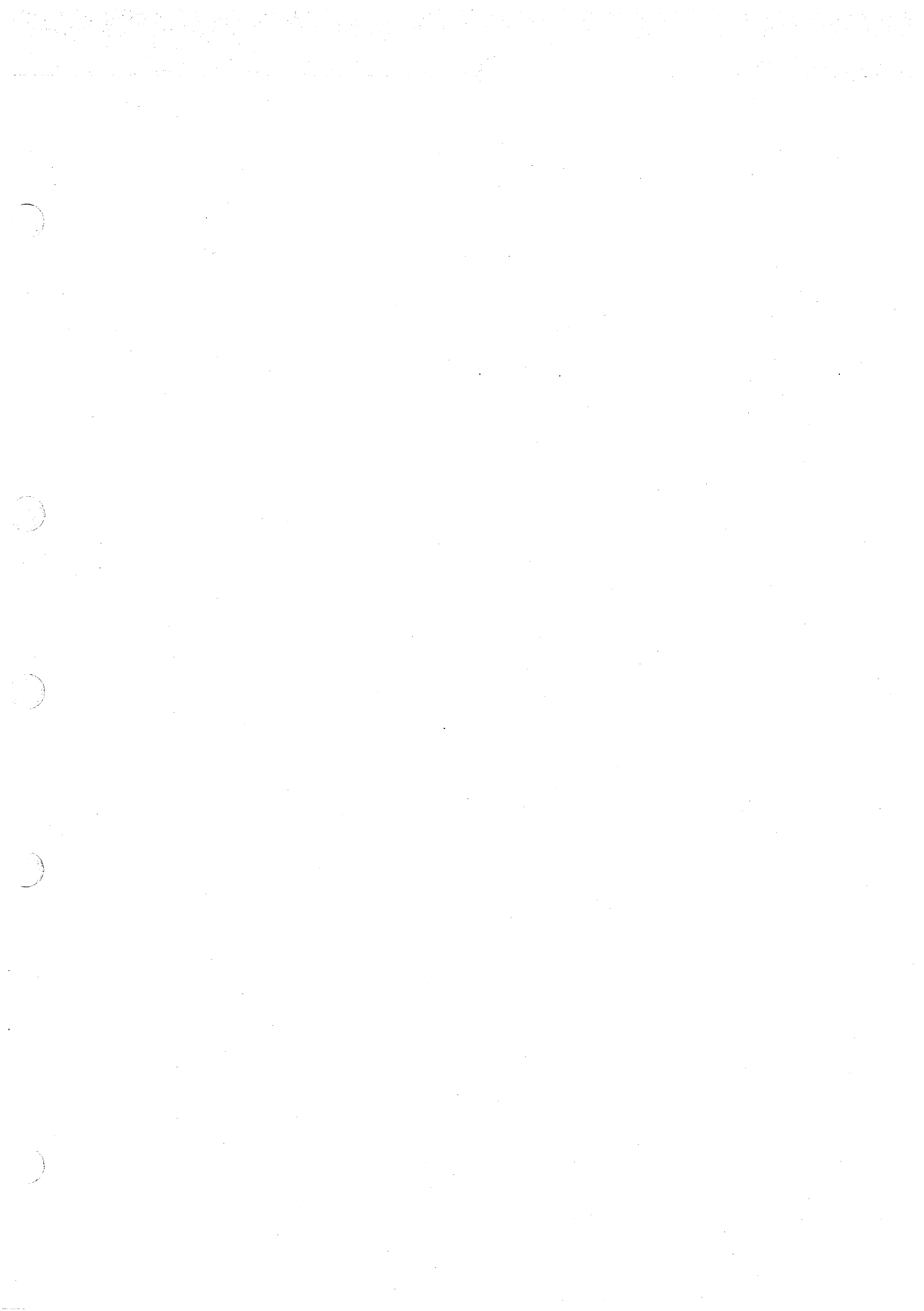

3.4 KEYBOARD UNIT

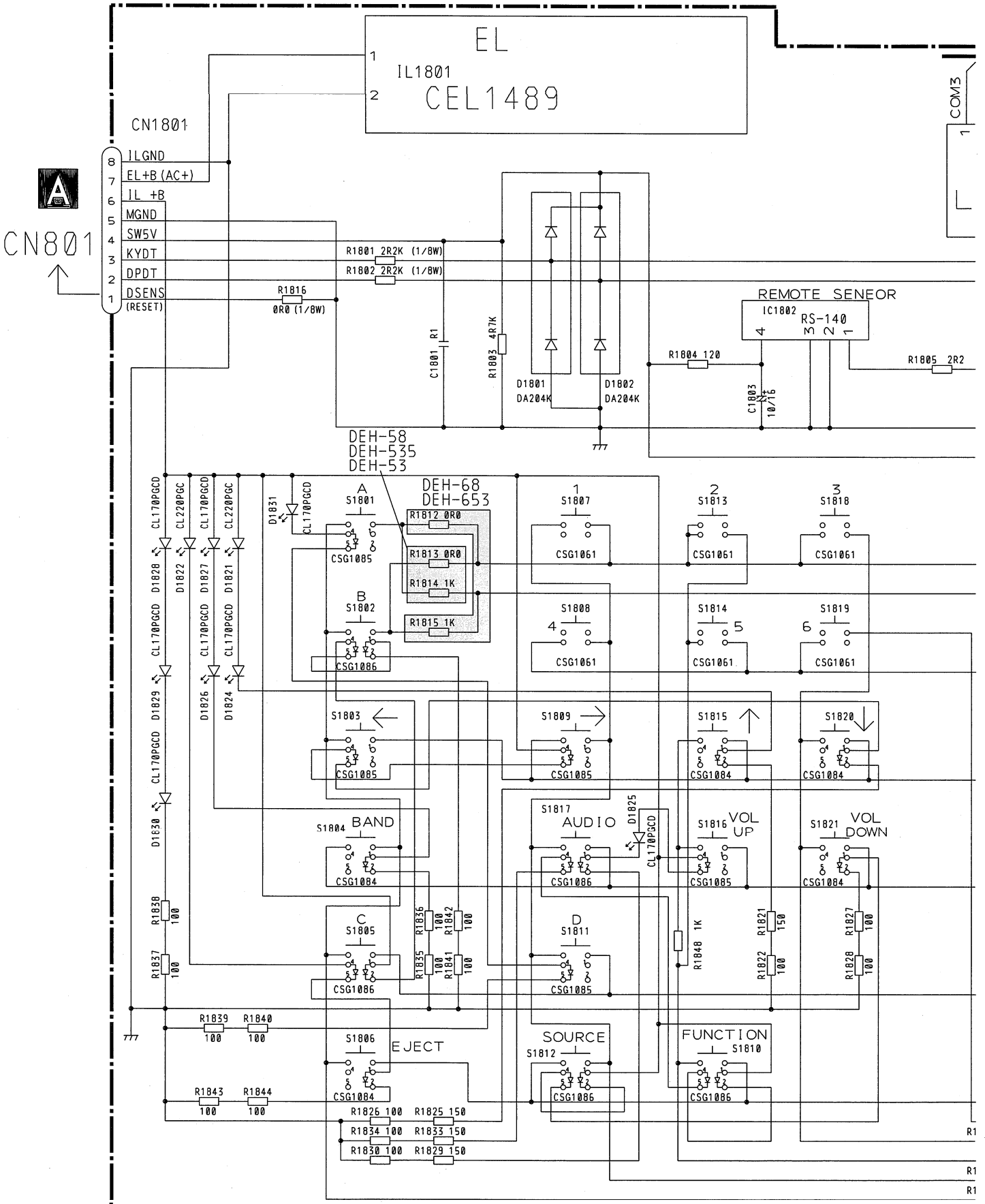



KEYBOARD UNIT

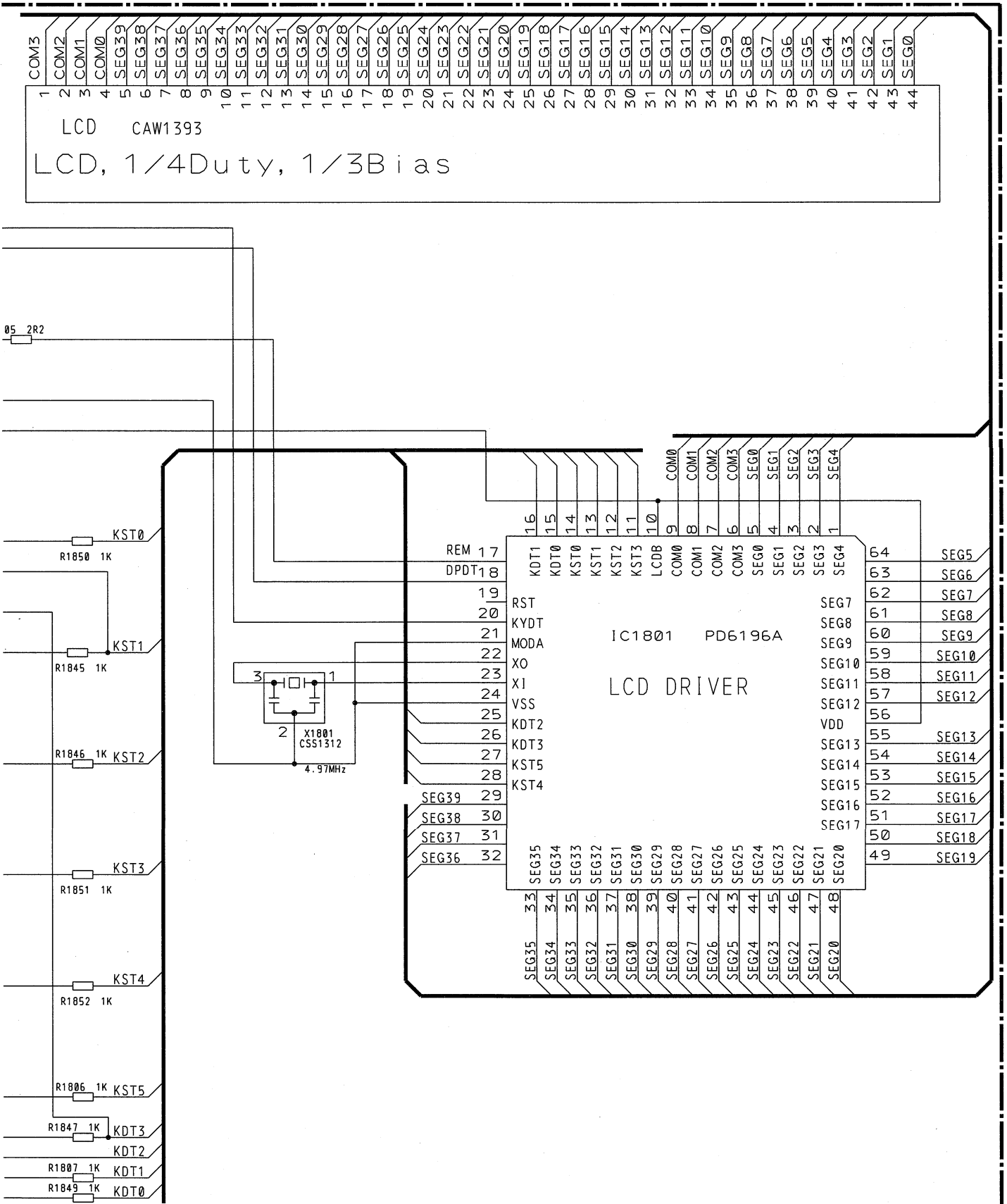

Fig. 15



3.5 FM/AM TUNER UNIT

A

B FM/AM TUNER UNIT

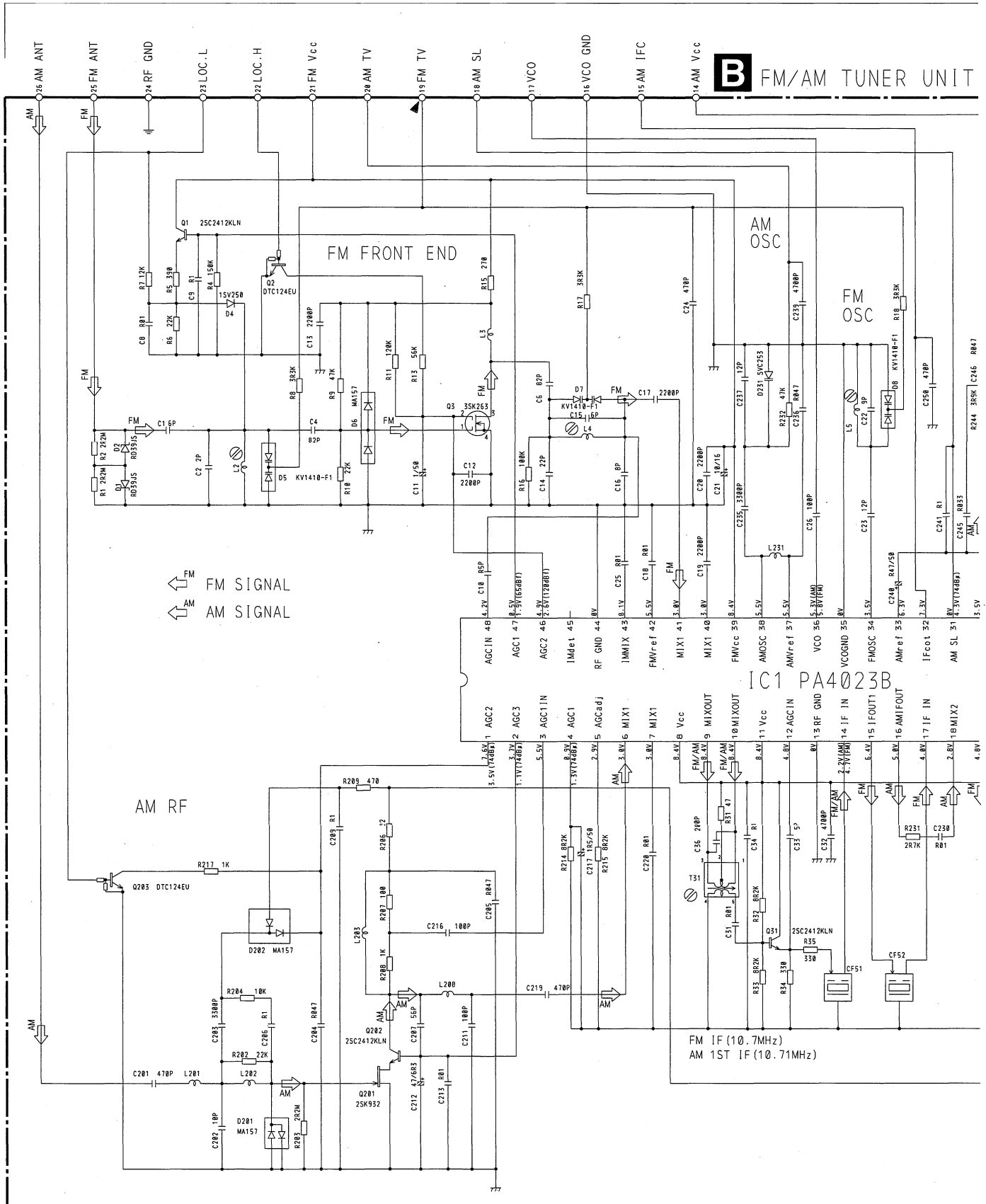

B

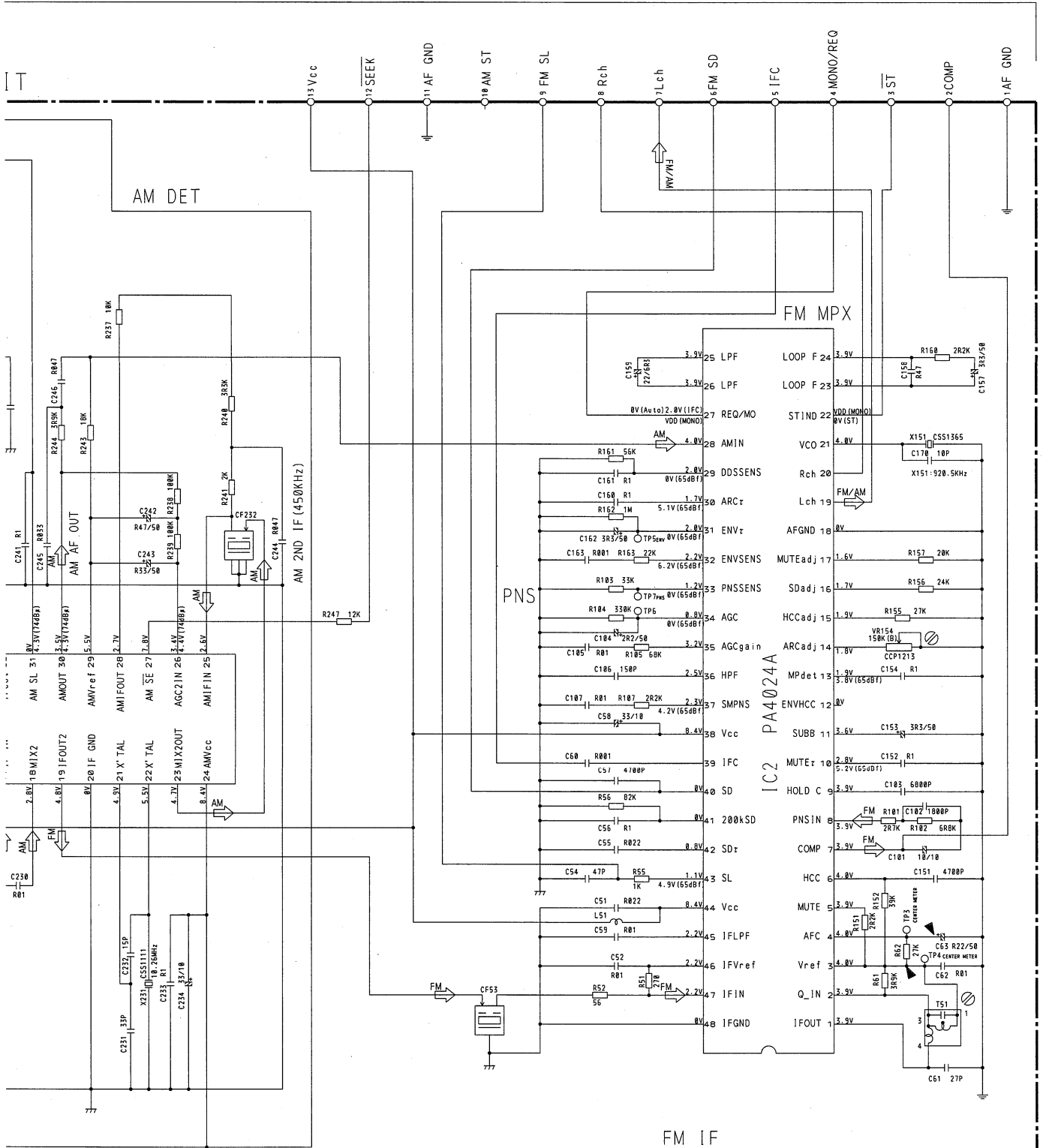
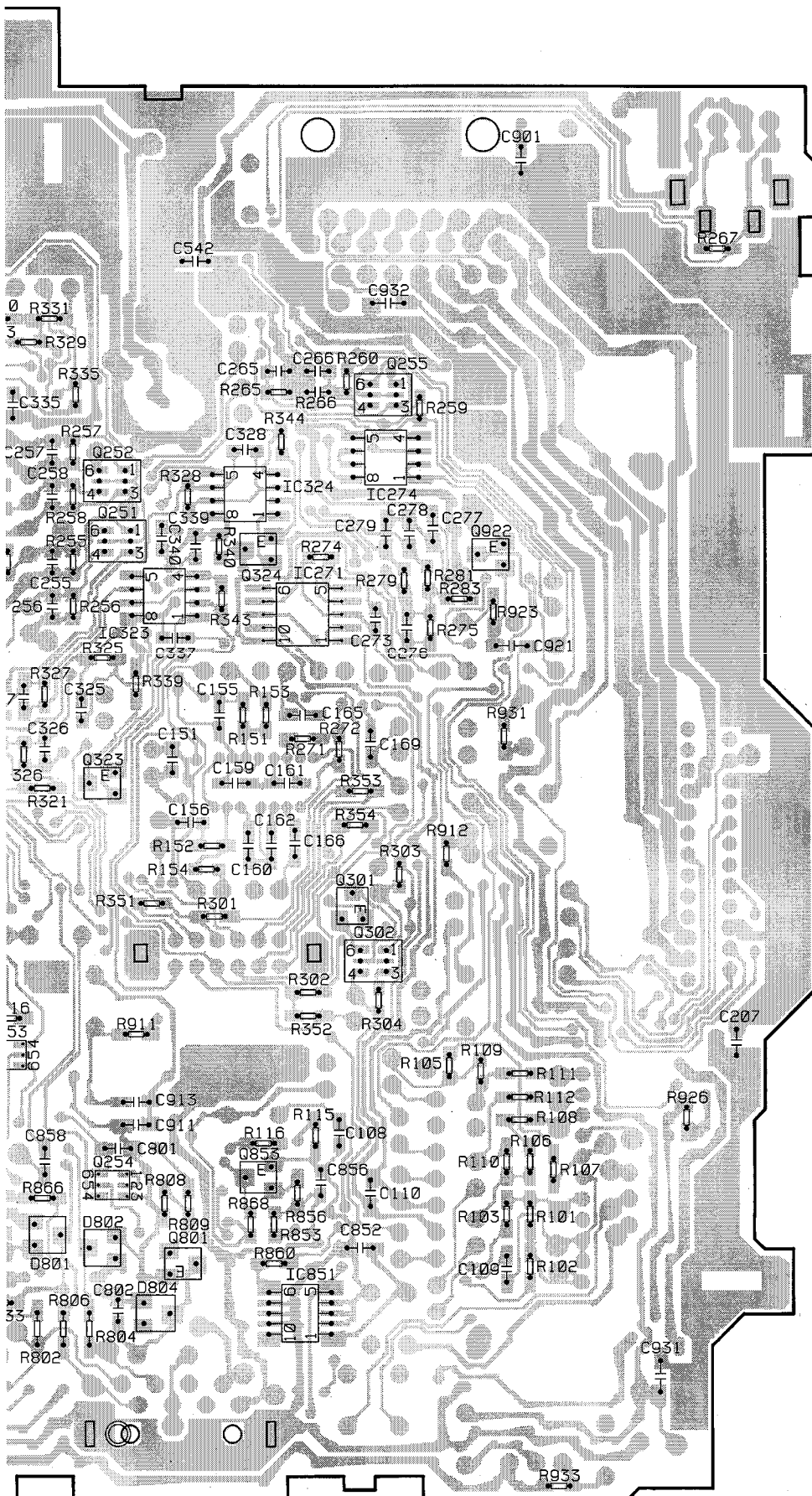

Fig. 16





IC, Q

SIDE B

Q501
Q143 Q144

Q141
Q701

Q255

Q252
IC324
IC274
Q251
Q922

Q324 IC271

IC732
IC323

IC702

Q323

Q301

Q302

Q253

Q806
Q254 Q853

Q808
Q803
Q801
Q972 Q102
Q805

Q923
Q941 Q804
Q957 Q601

Q921

Fig. 18

4.2 CD MECHANISM MODULE

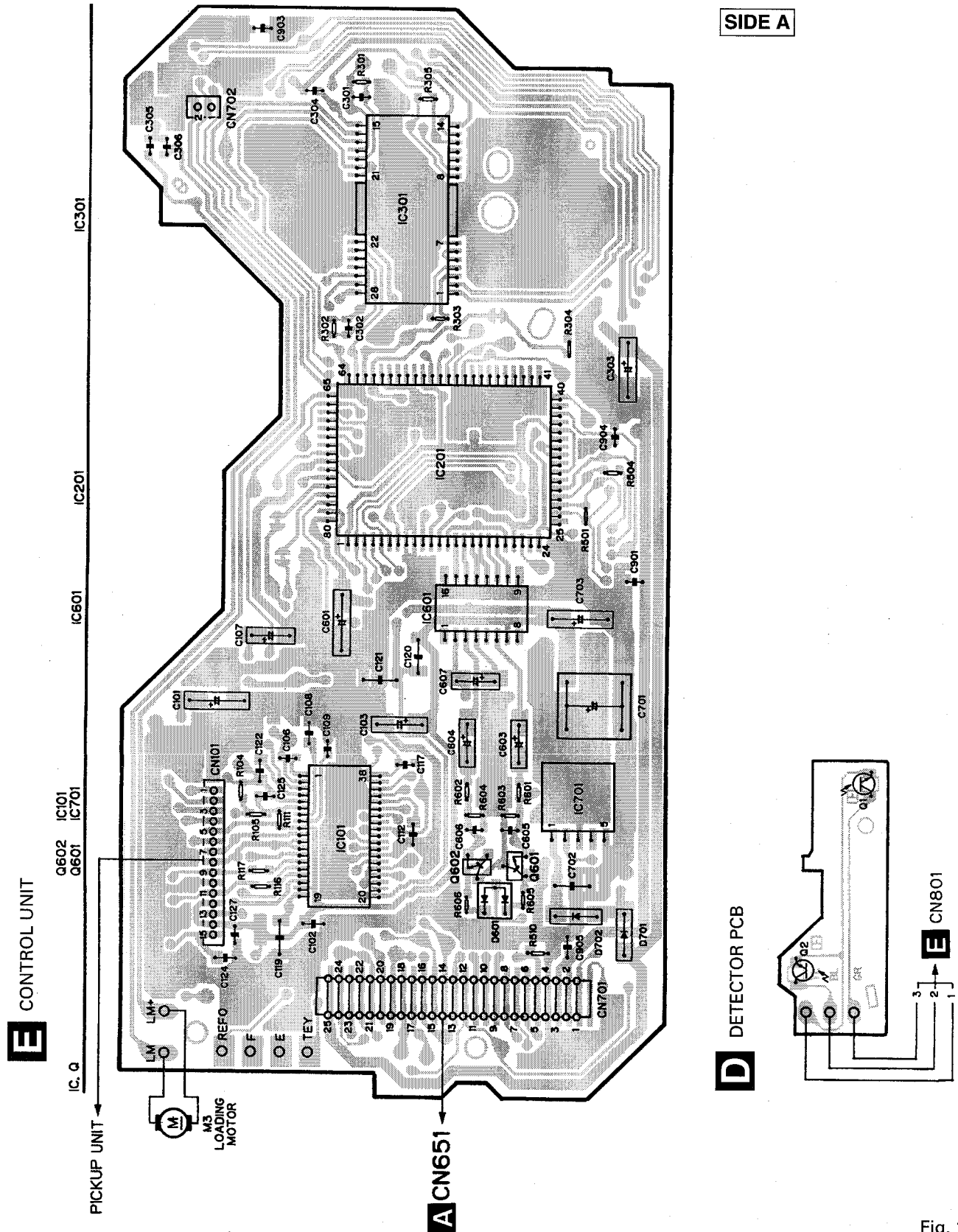

Fig. 19

E CONTROL UNIT

IC Q Q102 Q101 Q603
IC501
IC302

SIDE B

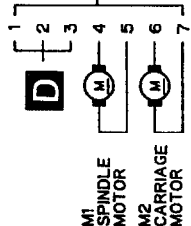
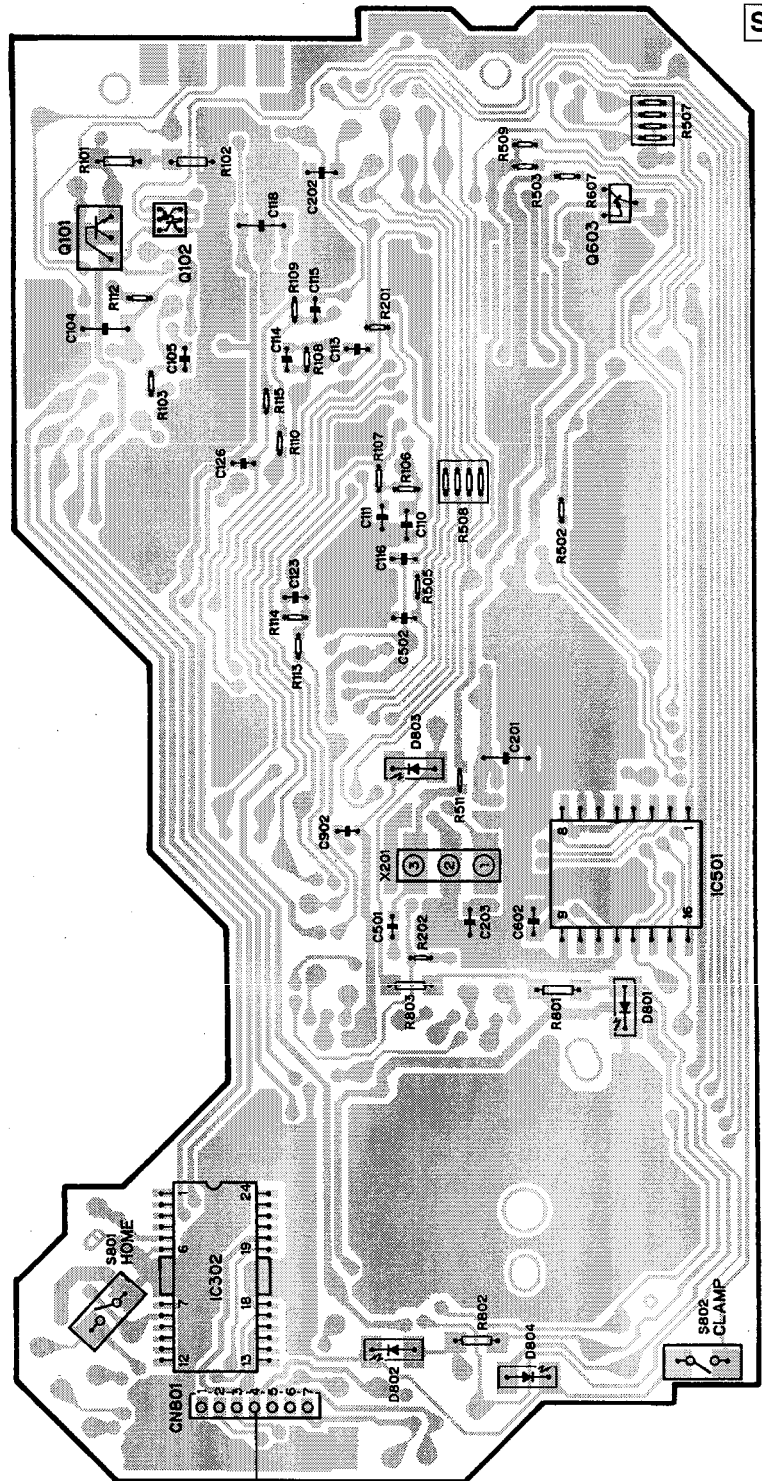
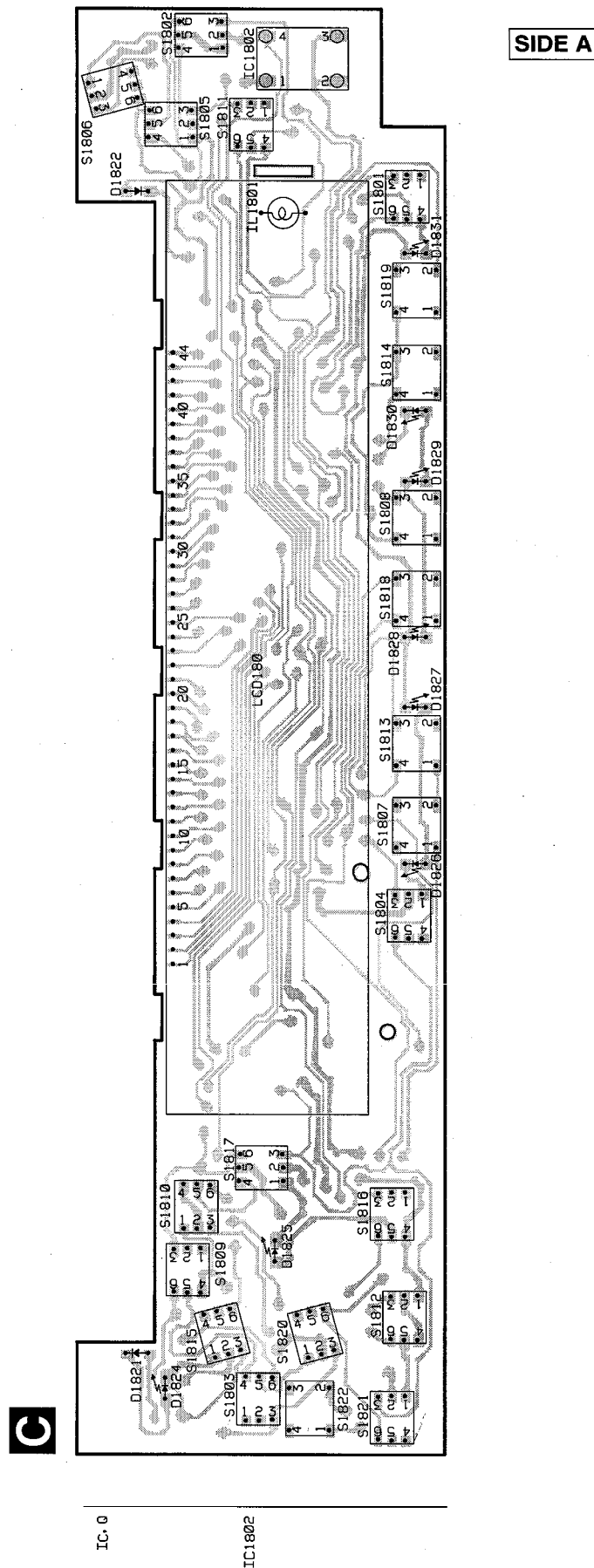

Fig. 20



4.3 KEYBOARD UNIT



SIDE A



Fig. 21

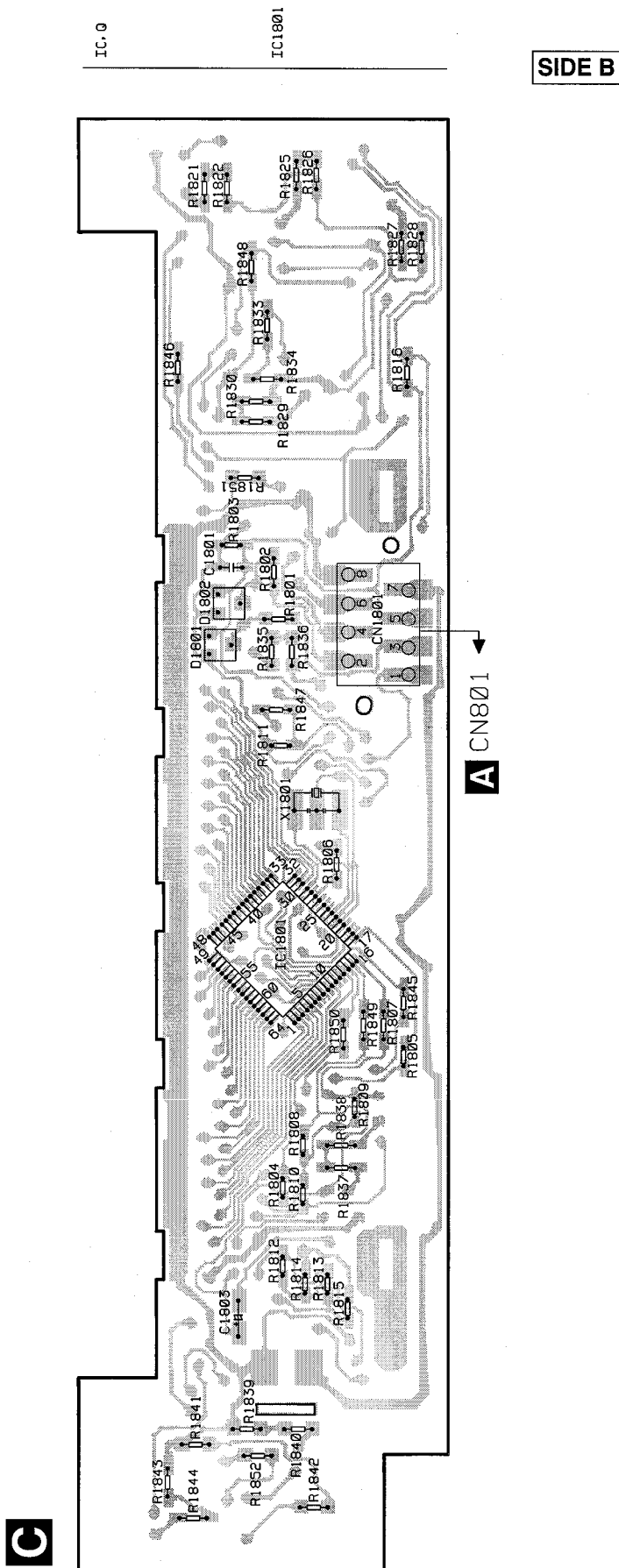

Fig. 22

4.4 FM/AM TUNER UNIT

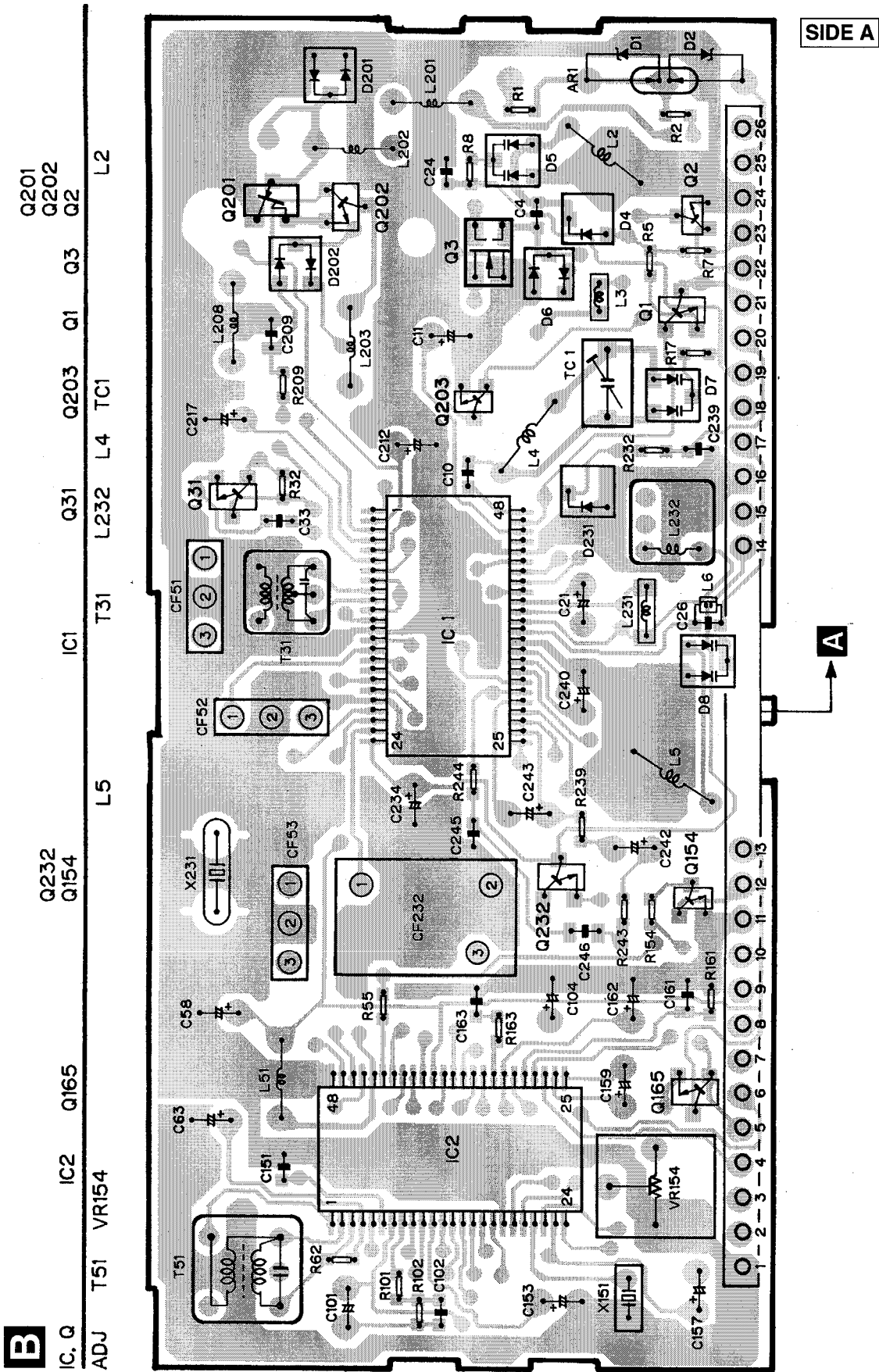
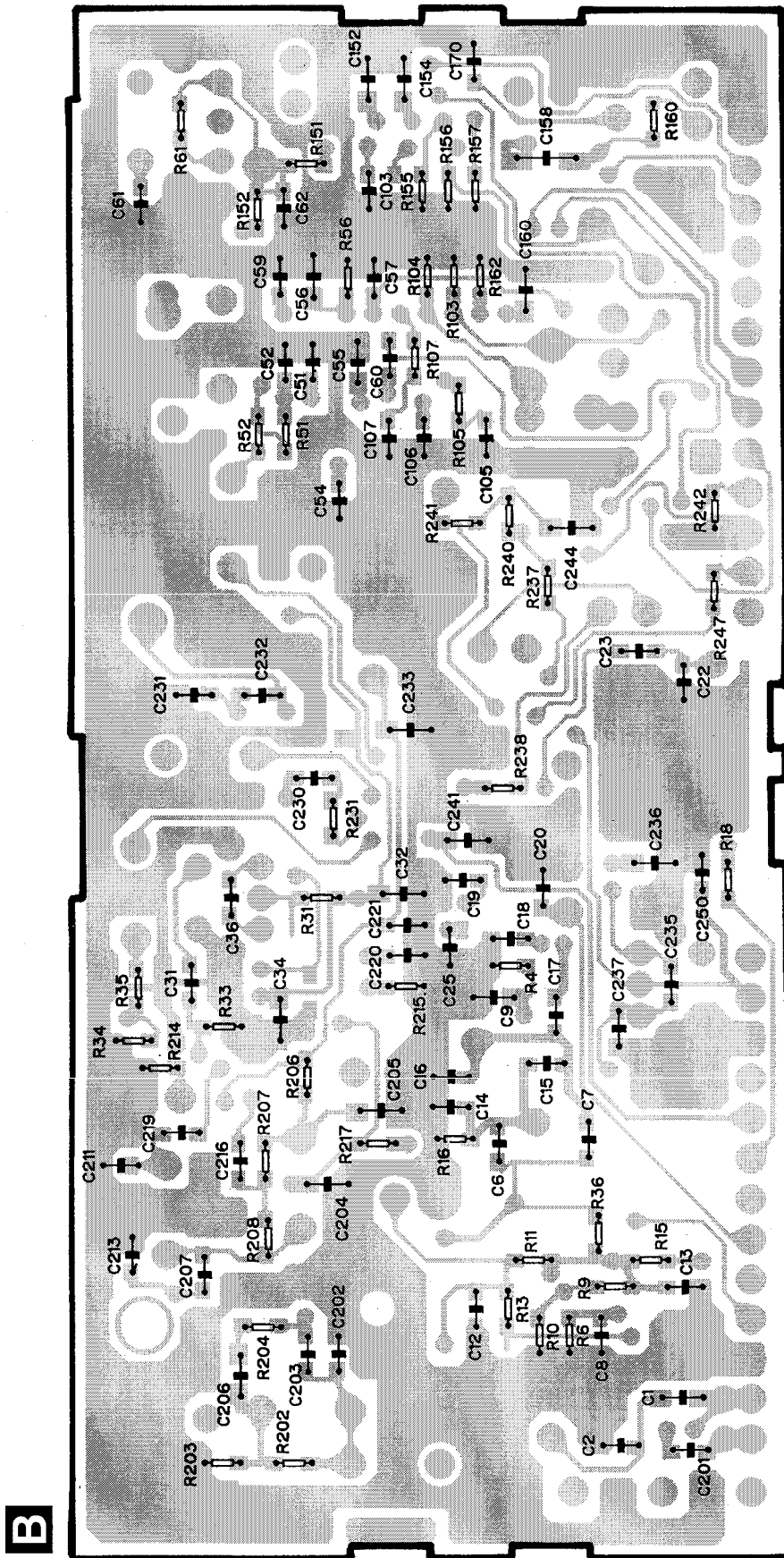

Fig. 23

SIDE B



B

Fig. 24

B

5. ELECTRICAL PARTS LIST

(1)PARTS LIST

NOTE:

- Parts whose parts numbers are omitted are subject to being not supplied.
- The part numbers shown below indicate chip components.

Chip Resistor

RS1/OSOOOJ,RS1/OOSOOOJ

Chip Capacitor (except for CQS.....)

CKS....., CCS....., CSZS.....

====Circuit Symbol & No.====Part Name	Part No.	====Circuit Symbol & No.====Part Name	Part No.
B Unit Number : CWE1417		R 13	RS1/16S563J
Unit Name : FM/AM Tuner Unit		R 15	RS1/16S271J
MISCELLANEOUS		R 16	RS1/16S104J
IC 1 IC	PA4023B	R 17	RS1/16S332J
IC 2 IC	PA4024A	R 18	RS1/16S332J
Q 1 Transistor	2SC2412KLN	R 31	RS1/16S470J
Q 2 Transistor	DTC124EU	R 32	RS1/16S822J
Q 3 FET	3SK263	R 33	RS1/16S822J
		R 34	RS1/16S331J
		R 35	RS1/16S331J
Q 31 Transistor	2SC2412KLN		
Q 201 FET	2SK932	R 51	RS1/16S271J
Q 202 Transistor	2SC2412KLN	R 52	RS1/16S560J
Q 203 Transistor	DTC124EU	R 55	RS1/16S102J
D 1 Diode	RD39JS	R 56	RS1/16S823J
		R 61	RS1/16S392J
D 2 Diode	RD39JS		
D 4 Diode	1SV250	R 62	RS1/16S273J
D 5 Diode	KV1410-F1	R 101	RS1/16S272J
D 6 Diode	MA157	R 102	RS1/16S682J
D 7 Diode	KV1410-F1	R 103	RS1/16S333J
		R 104	RS1/16S334J
D 8 Diode	KV1410-F1		
D 201 Diode	MA157	R 105	RS1/16S683J
D 202 Diode	MA157	R 107	RS1/16S222J
D 231 Diode	SVC253	R 151	RS1/16S222J
L 2 Coil	CTC1108	R 152	RS1/16S393J
		R 155	RS1/16S273J
L 3 Inductor	LCTB2R2K2125		
L 4 Coil	CTC1108	R 156	RS1/16S243J
L 5 Coil	CTC1107	R 157	RS1/16S203J
L 51 Ferri-Inductor	LAU150K	R 160	RS1/16S222J
L 201 Ferri-Inductor	LAU4R7K	R 161	RS1/16S563J
		R 162	RS1/16S105J
L 202 Ferri-Inductor	LAU330K		
L 203 Inductor	CTF1287	R 163	RS1/16S223J
L 208 Inductor	LAU121K	R 202	RS1/16S223J
L 231 Inductor	LCTA3R3J3225	R 203	RS1/16S225J
T 31 Coil	CTE1116	R 204	RS1/16S103J
		R 206	RS1/16S220J
T 51 Coil	CTC1136		
CF 51 Ceramic Filter	CTF1290	R 207	RS1/16S101J
CF 52 Ceramic Filter	CTF1290	R 208	RS1/16S102J
CF 53 Ceramic Filter	CTF1290	R 209	RS1/16S471J
CF 232 Ceramic Filter	CTF1348	R 214	RS1/16S822J
		R 215	RS1/16S822J
X 151 Resonator 920.5kHz	CSS1365		
X 231 Crystal Resonator 10.26MHz	CSS1111	R 217	RS1/16S102J
VR 154 Semi-fixed 150kΩ(B)	CCP1213	R 231	RS1/16S272J
		R 232	RS1/16S473J
		R 237	RS1/16S103J
		R 238	RS1/16S104J
RESISTORS			
R 1	RS1/16S225J		
R 2	RS1/16S225J	R 239	RS1/16S104J
R 4	RS1/16S154J	R 240	RS1/16S332J
R 5	RS1/16S391J	R 241	RS1/16S202J
R 6	RS1/16S223J	R 243	RS1/16S183J
		R 244	RS1/16S392J
R 7	RS1/16S123J		
R 8	RS1/16S332J	R 247	RS1/16S123J
R 9	RS1/16S473J		
R 10	RS1/16S223J		
R 11	RS1/16S124J		

====Circuit Symbol & No.====Part Name	Part No.	====Circuit Symbol & No.====Part Name	Part No.
CAPACITORS			
C 1	CCSQCH6R0D50	C 207	CCSRCH560J50
C 2	CCSRCK2R0C50	C 209	CKSQYB104K16
C 4	CCSRCH820J50	C 211	CCSRCH101J50
C 6	CCSRCH820J50	C 212	CEJA470M6R3
C 8	CKSRYP103K25	C 213	CKSRYP103K25
C 9	CKSQYB104K16	C 216	CCSRCH101J50
C 10	CCSRCKR50C50	C 217	CEJA1R5M50
C 11	CEJA1R0M50	C 219	CCSRCH471J50
C 12	CKSRYP222K50	C 220	CKSRYP103K25
C 13	CKSRYP222K50	C 230	CKSRYP103K25
C 14	CCSRCH220J50	C 231	CCSRCH330J50
C 15	CCSRCH6R0D50	C 232	CCSRCH150J50
C 16	CCSRCH8R0D50	C 233	CKSQYB104K16
C 17	CKSRYP222K50	C 234	CEJA330M10
C 18	CKSRYP103K25	C 235	CKSRYP332K50
C 19	CKSRYP222K50	C 236	CKSQYB473K16
C 20	CKSRYP222K50	C 237	CCSRCH120J50
C 21	CEJA100M16	C 239	CKSRYP472K50
C 22	CCSRTH9R0D50	C 240	CEJAR47M50
C 23	CCSRTH120J50	C 241	CKSQYB104K16
C 24	CCSRCH471J50	C 242	CEJAR47M50
C 25	CKSRYP103K25	C 243	CEJAR33M50
C 26	CCSRCH101J50	C 244	CKSQYB473K16
C 31	CKSRYP103K25	C 245	CKSRYP333K16
C 32	CKSQYB472K50	C 246	CKSQYB473K16
C 33	CCSRCH5R0C50	C 250	CCSRCH471J50
C 34	CKSQYB104K16	E Unit Number : CWX1889 Unit Name : Control Unit	
C 36	CCSRRH201J50		
C 51	CKSRYP222K25	MISCELLANEOUS	
C 52	CKSRYP103K25	IC 101	IC
C 54	CCSRCH470J50	IC 201	IC
C 55	CKSQYB223K25	IC 301	IC
C 56	CKSQYB104K16	IC 302	IC
C 57	CKSRYP472K50	IC 601	IC
C 58	CEJA330M10	IC 701	IC
C 59	CKSRYP103K25	Q 101	Transistor
C 60	CKSRYP102K50	Q 102	Transistor
C 61	CCSRCH270J50	Q 601	Transistor
C 62	CKSRYP103K25	Q 602	Transistor
C 63	CEJAR22M50	Q 603	Transistor
C 101	CEJANP100M10	D 601	Diode
C 102	CKSRYP182K50	D 701	Diode
C 103	CKSRYP682K25	D 702	Diode
C 104	CEJA2R2M50	D 801	
C 105	CKSRYP103K25	D 802	
C 106	CCSRCH151J50	X 201	Ceramic Resonator 16.93MHz
C 107	CKSRYP103K25	S 801	Switch(Home)
C 151	CKSRYP472K50	S 802	Switch(Clamp)
C 152	CKSQYB104K16	RESISTORS	
C 153	CEJA3R3M50	R 101	RS1/8S100J
C 154	CKSQYB104K16	R 102	RS1/8S120J
C 157	CEJA3R3M50	R 103	RS1/16S102J
C 158	CKSYB474K16	R 104	RS1/16S822J
C 159	CEJA220M6R3	R 105	RS1/16S682J
C 160	CKSQYB104K16	R 106	RS1/16S183J
C 161	CKSQYB104K16	R 107	RS1/16S822J
C 162	CEJA3R3M50	R 108	RS1/16S333J
C 163	CKSRYP102K50	R 109	RS1/16S683J
C 170	CCSRCH100D50	R 110	RS1/16S134J
C 201	CCSRCH471J50	R 111	RS1/16S273J
C 202	CCSRCH100D50	R 112	RS1/16S222J
C 203	CKSRYP332K50	R 113	RS1/16S103J
C 204	CKSQYB473K16	R 114	RS1/16S103J
C 205	CKSQYB473K16	R 115	RS1/16S102J
C 206	CKSQYB104K16		

DEH-68,635,58,535,53

====Circuit Symbol & No.====Part Name	Part No.	====Circuit Symbol & No.====Part Name	Part No.
R 116	RS1/16S163J	C 901	CCSRCH471J50
R 117	RS1/16S163J	C 902	CCSRCH271J50
R 201	RS1/16S104J	C 903	CCSRCH471J50
R 202	RS1/16S473J	C 904	CCSRCH101J50
R 304	RS1/16S0R0J		
R 501	RS1/16S0R0J	A Unit Number :	
R 505	RS1/16S102J	Unit Name : Tuner Amp Unit	
R 507	RA4C102J		
R 508	RA4C681J	MISCELLANEOUS	
R 510	RS1/10S0R0J	IC 151 IC	SN761027DL
R 601	RS1/16S102J	IC 201 IC	TDA7386
R 602	RS1/16S102J	IC 271 IC	See Contrast table
R 603	RS1/16S223J	IC 272 IC	See Contrast table
R 604	RS1/16S223J	IC 273 IC	See Contrast table
R 605	RS1/16S162J	IC 501 IC	PM2005B
R 606	RS1/16S162J	IC 601 IC	See Contrast table
R 607	RS1/16S103J	IC 701 IC	See Contrast table
R 801	RS1/8S751J	IC 751 IC	See Contrast table
R 802	RS1/8S751J	IC 851 IC	See Contrast table
CAPACITORS		IC 941 IC	S-80734ANDYI
C 101	CEV101M6R3	Q 201 Transistor	DTC144EK
C 102	CKSQYB104K16	Q 251 Transistor	See Contrast table
C 103	CEV470M6R3	Q 252 Transistor	See Contrast table
C 104	CKSYB334K16	Q 253 Transistor	IMD2A
C 105	CCSRCH330J50	Q 254 Transistor	See Contrast table
C 106	CKSRYP103K25	Q 255 Transistor	IMH3A
C 107	CEV4R7M35	Q 301 Transistor	See Contrast table
C 108	CKSQYB273K50	Q 302 Transistor	See Contrast table
C 109	CCSRCH101J50	Q 501 Transistor	2SC2712
C 110	CKSQYB104K16	Q 502 Transistor	DTC124EK
C 111	CKSRYP332K50	Q 601 Transistor	See Contrast table
C 112	CKSQYB473K16	Q 801 Transistor	2SA1162
C 113	CKSRYP103K25	Q 802 Transistor	2SD1760F5
C 114	CKSRYP391K50	Q 803 Transistor	DTC114EK
C 115	CCSRCH121J50	Q 804 Transistor	DTA143EK
C 116	CKSRYP682K25	Q 805 Transistor	DTC114EK
C 117	CKSRYP333K16	Q 806 Transistor	2SC2712
C 118	CKSYB334K16	Q 807 Transistor	2SB1238
C 119	CKSYB334K16	Q 808 Transistor	DTC143EK
C 120	CKSYB334K16	Q 809 Transistor	2SD1864
C 121	CKSYB334K16	Q 851 Transistor	See Contrast table
C 122	CKSQYB104K16	Q 852 Transistor	See Contrast table
C 123	CKSRYP472K50	Q 853 Transistor	See Contrast table
C 124	CKSQYB104K16	Q 854 Transistor	See Contrast table
C 125	CCSRCH6R0D50	Q 911 Transistor	2SD1760F5
C 126	CKSRYP153K25	Q 921 Transistor	IMX1
C 127	CCSRCH102J25	Q 922 Transistor	DTC114EK
C 201	CKSYB334K16	Q 923 Transistor	2SC2712
C 202	CKSQYB104K16	Q 931 Transistor	See Contrast table
C 203	CKSQYB104K16	Q 932 Transistor	See Contrast table
C 303	CEV470M16	Q 941 Transistor	See Contrast table
C 304	CKSRYP103K25	Q 951 Transistor	See Contrast table
C 305	CKSRYP103K25	Q 952 Transistor	2SD2396
C 306	CKSRYP103K25	Q 953 Transistor	2SB1243
C 502	CKSRYP471K50	Q 954 Transistor	DTC124EK
C 601	CEV101M6R3	Q 955 Transistor	2SA1674
C 602	CKSQYB104K16	Q 956 Transistor	2SA1674
C 603	CEV4R7M35	Q 957 Transistor	IMH1A
C 604	CEV4R7M35	Q 971 Transistor	2SC2712
C 605	CKSRYP152K50	Q 972 Transistor	2SD2396
C 606	CKSRYP152K50	D 201 Diode	IMD2A
C 607	CEV220M6R3	D 251 Diode	DAN202K
C 701	CCH1233	D 252 Diode	1SS133
C 702	CKSYB334K16	D 501 Diode	See Contrast table
C 703	CEV101M6R3	D 801 Diode	DAN202K
		D 802 Diode	DA204K
		D 803 Diode	DA204K
		D 804 Diode	DA204K
		D 805 Diode	MA3062(M)
			MA3075(L)

22μF/6.3V

DEH-68,635,58,535,53

====Circuit Symbol & No.====Part Name	Part No.	====Circuit Symbol & No.====Part Name	Part No.
R 611	RS1/10S222J	R 858	See Contrast table
R 612	RS1/10S681J	R 860	See Contrast table
R 613	RS1/10S681J	R 861	See Contrast table
R 614	RS1/10S681J	R 862	See Contrast table
R 615	RS1/10S681J	R 863	See Contrast table
R 616	See Contrast table	R 864	See Contrast table
R 617	See Contrast table	R 865	See Contrast table
R 618	See Contrast table	R 866	See Contrast table
R 619	RS1/10S393J	R 867	See Contrast table
R 620	RS1/10S473J	R 868	See Contrast table
R 621	RS1/10S473J	R 869	See Contrast table
R 622	RS1/10S222J	R 911	RS1/10S392J
R 623	RS1/10S473J	R 912	RS1/10S101J
R 624	See Contrast table	R 921	RS1/10S103J
R 625	See Contrast table	R 922	RS1/10S473J
R 626	RS1/10S473J	R 923	RS1/10S103J
R 627	RS1/10S473J	R 924	RS1/10S103J
R 628	RS1/10S393J	R 925	RS1/10S473J
R 629	RS1/10S473J	R 926	RS1/10S472J
R 630	See Contrast table	R 927	RS1/8S224J
R 631	See Contrast table	R 933	See Contrast table
R 632	RN1/10SE2202D	R 934	See Contrast table
R 634	RS1/10S102J	R 941	RS1/10S102J
R 635	RS1/10S0R0J	R 942	RS1/10S822J
R 651	RS1/10S681J	R 943	See Contrast table
R 652	RS1/10S681J	R 946	See Contrast table
R 653	RS1/10S681J	R 951	RD1/4PU221J
R 654	RS1/10S681J	R 952	RD1/4PU301J
R 701	See Contrast table	R 953	RS1/10S1R0J
R 702	See Contrast table	R 954	RD1/4PU331J
R 703	See Contrast table	R 955	RD1/4PU331J
R 704	See Contrast table	R 956	RS1/10S472J
R 705	See Contrast table	R 957	RD1/4PU102J
R 706	See Contrast table	R 958	RS1/10S472J
R 707	See Contrast table	R 959	RD1/4PU102J
R 708	See Contrast table	R 960	RS1/10S472J
R 710	See Contrast table	R 961	RS1/10S103J
R 713	See Contrast table	R 962	RS1/10S473J
R 714	See Contrast table	R 963	RS1/10S473J
R 715	See Contrast table	R 965	RS1/10S0R0J
R 716	See Contrast table	R 971	RD1/4PU221J
R 717	See Contrast table	R 972	RS1/10S221J
R 728	See Contrast table	R 973	RS1/10S472J
R 751	See Contrast table	R 974	RS1/10S222J
R 802	RS1/8S222J		
R 804	RS1/8S222J	CAPACITORS	
R 806	RS1/8S222J	C 133	CKSQYB473K50
R 807	RS1/10S102J	C 134	CKSQYB473K50
R 808	RS1/10S223J	C 135	CEJA4R7M35
R 809	RS1/10S682J	C 136	CEJA4R7M35
		C 137	CEJA2R2M50
R 810	RS2PMF100J		
R 811	RD1/4PU471J	C 138	CEJA2R2M50
R 812	RS1/10S103J	C 151	CKSQYB473K50
R 813	RS1/10S224J	C 152	CEJA470M10
R 814	RS1/10S222J	C 153	CEJANP100M16
		C 154	CEJANP100M16
R 815	RD1/4PU102J		
R 816	RS1/10S132J	C 155	CKSQYB822K50
R 817	RS1/10S822J	C 156	CKSQYB822K50
R 818	RS1/10S104J	C 157	CEJA1R0M50
R 819	RS2PMF220J	C 158	CEJA1R0M50
		C 159	CKSQYB183K50
R 851	See Contrast table		
R 852	See Contrast table	C 160	CKSQYB183K50
R 853	See Contrast table	C 161	CKSQYB102K50
R 854	See Contrast table	C 162	CKSQYB102K50
R 856	See Contrast table	C 163	CEJANP2R2M35
		C 164	CEJANP2R2M35

DEH-68,635,58,535,53

====Circuit Symbol & No.====Part Name	Part No.	====Circuit Symbol & No.====Part Name	Part No.
C 165	CKSQYB333K50	C 531	CKSQYB223K50
C 166	CKSQYB333K50	C 532	CKSQYB223K50
C 167	CEJA220M16	C 534	CCSQCH101K50
C 168	CEJA2R2M50	C 536	CKSQYB103K50
C 169	CKSQYB104K50	C 538	CKSQYB103K50
C 201	CKSQYB224K16	C 601	CEJA4R7M35
C 202	CKSQYB224K16	C 602	CKSQYB103K50
C 203	CKSQYB224K16	C 603	CKSQYB473K50
C 204	CKSQYB224K16	C 605	CKSQYB473K50
C 205	CEJA1R0M50	C 651	CCSQCH821J50
C 206	CCH1150	C 652	CCSQCH821J50
C 207	CKSQYB473K50	C 701	See Contrast table
C 208	CEJA100M16	C 705	See Contrast table
C 209	CEJA1R0M50	C 709	See Contrast table
C 210	CEJA330M16	C 710	See Contrast table
C 251	See Contrast table	C 751	See Contrast table
C 252	See Contrast table	C 802	CKSQYB104K25
C 253	CEJA4R7M35	C 803	CEJA100M16
C 254	CEJA4R7M35	C 804	CKSQYB103K50
C 255	See Contrast table	C 805	CEJA100M16
C 256	See Contrast table	C 806	CKSQYB103K50
C 257	See Contrast table	C 807	CKSQYB333K50
C 258	See Contrast table	C 808	CKSQYB333K50
C 271	See Contrast table	C 852	See Contrast table
C 272	See Contrast table	C 853	See Contrast table
C 273	See Contrast table	C 855	See Contrast table
C 274	See Contrast table	C 856	See Contrast table
C 275	See Contrast table	C 857	See Contrast table
C 276	See Contrast table	C 858	See Contrast table
C 277	See Contrast table	C 911	CKSQYB103K50
C 278	See Contrast table	C 913	CKSQYB472K50
C 279	See Contrast table	C 914	CCH1149
C 280	See Contrast table	C 915	CEJA470M10
C 281	See Contrast table	C 921	CKSYB105K16
C 282	See Contrast table	C 922	CKSYB102K50
C 284	See Contrast table	C 931	See Contrast table
C 291	See Contrast table	C 932	CKSYB103K50
C 301	See Contrast table	C 941	CEJA2R2M50
C 302	See Contrast table	C 951	CKSQYB103K50
C 501	CCSQCH150K50	C 952	CEJA101M16
C 502	CCSQCH150K50	C 954	CEAS331M10
C 503	CKSQYB103K50	C 971	CKSQYB473K50
C 504	CKSQYB103K50	C 972	CKSQYB102K50
C 505	CCSQCH101K50	C 973	CEAL101M10
C 506	CKSQYB103K50		
C 507	CKSQYB103K50		
C 508	CKSQYB102K50		
C 509	CEJA220M10		
C 510	CKSQYB223K50		
C 513	CKSQYB103K50		
C 514	CCSQCH101K50		
C 515	CEJA220M6R3		
C 516	CKSQYB103K50		
C 517	CEJA220M6R3		
C 518	CKSQYB103K50		
C 519	CEJA220M10		
C 520	CKSQYB103K50		
C 521	CCH1250		
C 522	CKSQYB103K50		
C 523	CKLSR473K16		
C 524	CKSQYB332K50		
C 525	CCH1250		
C 526	CKSQYB103K50		
C 528	CKSQYB103K50		
C 529	CKSQYB103K50		

**CONTRAST TABLE of TUNER AMP UNIT
DEH-68/UC, DEH-635/UC, DEH-58/UC, DEH-535/UC and DEH-53/UC have the same construction except for the following:**

Symbol & Description	Part No.	
	DEH-68/UC	DEH-635/UC
IC271 IC	M5282FP	Not used
IC272 IC	MC14052BF	Not used
IC273 IC	NJM2068MD	Not used
IC851 IC	TPD1018F	Not used
Q252 Transistor	IMH3A	Not used
Q254 Transistor	IMD2A	Not used
Q853 Transistor	DTC123EK	Not used
Q854 Transistor	DTC123EK	Not used
D252 Diode	1SS133	Not used
D858, 860 Diode	ERA15-02VH	Not used
R253, 254	RS1/10S681J	Not used
R257, 258	RS1/10S223J	Not used
R259	Not used	RS1/10S681J
R260	RS1/10S821J	RS1/10S681J
R263, 267	RS1/10S0R0J	Not used

DEH-68,635,58,535,53

Symbol & Description	Part No.	
	DEH-68/UC	DEH-635/UC
R264	RS1/10S0R0J	Not used
R265	Not used	RS1/10S223J
R268, 269	Not used	RS1/10S0R0J
R271, 272	RS1/10S183J	Not used
R273, 277, 278	RS1/10S103J	Not used
R274	RS1/10S243J	Not used
R275	RS1/10S683J	Not used
R279, 281, 283	RS1/10S104J	Not used
R280, 282, 284	RS1/10S104J	Not used
R285	RS1/10S105J	Not used
R291, 867	RS1/10S473J	Not used
R624	RS1/10S104J	RS1/10S473J
R853, 860	RS1/10S103J	Not used
R856	RS1/10S163J	Not used
R858	RS1/10S163J	Not used
R863, 864	RD1/4PU102J	Not used
R868	RS1/10S473J	Not used
C257, 258	CCSQCH221J50	Not used
C271	CEJA220M10	Not used
C272	CEJA101M10	Not used
C273	CKSQYB472K50	Not used
C274, 284	CEJA4R7M35	Not used
C275	CEJANP220M10	Not used
C276	CKSQYB222K50	Not used
C277	CKSQYB183K50	Not used
C278, 852	CKSQYB473K50	Not used
C279	CKSQYB273K50	Not used
C280, 853	CKSYB103K50	Not used
C281	CKSQYB223K50	Not used
C282	CKSQYB153K50	Not used
C291, 855	CKSQYB103K50	Not used
C856	CKSQYB103K50	Not used

Symbol & Description	Part No.	
	DEH-68/UC	DEH-58/UC
IC601 IC	PD4808B	PD4721B
IC701 IC	PD6194A	Not used
IC751 IC	PD8027A	Not used
Q941 Transistor	DTA144TK	Not used
L701 Inductor	LAU100K	Not used
L751 Ferri-Inductor	LAU2R2K	Not used
X701 Radiator	CSS1338	Not used
S941 Switch	CSG1046	Not used
R602, 603, 604, 618	RS1/10S473J	Not used
R608, 609, 713, 714	RS1/10S473J	Not used
R616	Not used	RS1/10S473J
R617	RS1/10S0R0J	Not used
R701, 702	RS1/10S681J	Not used
R703	RS1/10S0R0J	Not used
R704	RS1/10S105J	Not used
R705	RS1/10S681J	Not used
R706	RS1/10S681J	Not used
R707, 708	RS1/10S681J	Not used
R710	RS1/10S473J	Not used
R715, 716, 717, 946	RS1/10S473J	Not used
R728	RA3C473J	Not used
R751	RS1/10S0R0J	Not used
R943	RS1/8S471J	Not used
C701	CKSYB224K16	Not used
C705, 709	CKSQYB103K50	Not used
C710	CASA1R0M16	Not used
C751	CEJA100M16	Not used

Symbol & Description	Part No.	
	DEH-68/UC	DEH-535/UC
IC271 IC	M5282FP	Not used
IC272 IC	MC14052BF	Not used
IC273 IC	NJM2068MD	Not used
IC601 IC	PD4808B	PD4721B
IC701 IC	PD6194A	Not used
IC751 IC	PD8027A	Not used
IC851 IC	TPD1018F	Not used
Q252 Transistor	IMH3A	Not used
Q254 Transistor	IMD2A	Not used
Q601 Transistor	DTC114EK	Not used
Q851 Transistor	IMD2A	Not used
Q852 Transistor	DTC143EK	Not used
Q853 Transistor	DTC123EK	Not used
Q854 Transistor	DTC123EK	Not used
Q931 Transistor	2SB1243	Not used
Q932 Transistor	DTC114EK	Not used
Q941 Transistor	DTA144TK	Not used
D252 Diode	1SS133	Not used
D851 LED	BR4361F	Not used
D858, 860, 933, 934 Diode	ERA15-02VH	Not used
L701 Inductor	LAU100K	Not used
L751 Ferri-Inductor	LAU2R2K	Not used
X701 Radiator	CSS1338	Not used
S941 Switch	CSG1046	Not used
BZ601 Buzzer	CPV1011	Not used
R253, 254, 705	RS1/10S681J	Not used
R257, 258	RS1/10S223J	Not used
R259	Not used	RS1/10S681J
R260	RS1/10S821J	RS1/10S681J
R263, 267, 703	RS1/10S0R0J	Not used
R264, 617	RS1/10S0R0J	Not used
R265	Not used	RS1/10S223J
R268, 269	Not used	RS1/10S0R0J
R271, 272	RS1/10S183J	Not used
R273, 277, 278, 852	RS1/10S103J	Not used
R274	RS1/10S243J	Not used
R275	RS1/10S683J	Not used
R279, 281, 283	RS1/10S104J	Not used
R280, 282, 284	RS1/10S104J	Not used
R285	RS1/10S105J	Not used
R291, 602, 603, 604	RS1/10S473J	Not used
R608, 609, 713, 714	RS1/10S473J	Not used
R616	Not used	RS1/10S473J
R618, 710, 867, 869	RS1/10S473J	Not used
R624	RS1/10S104J	RS1/10S473J
R630	RS1/10S202J	Not used
R631, 866	RS1/10S102J	Not used
R701, 702	RS1/10S681J	Not used
R704	RS1/10S105J	Not used
R706	RS1/10S681J	Not used
R707, 708	RS1/10S681J	Not used
R715, 716, 717, 868	RS1/10S473J	Not used
R728	RA3C473J	Not used
R751	RS1/10S0R0J	Not used
R851	RS1/8S331J	Not used
R853, 860, 865	RS1/10S103J	Not used
R854	RS1/10S303J	Not used
R856	RS1/10S163J	Not used
R858	RS1/10S163J	Not used
R861	RS1/10S103J	Not used
R862, 863, 864	RD1/4PU102J	Not used
R933	RS1/10S472J	Not used
R934	RD1/4PU272J	Not used
R943	RS1/8S471J	Not used
R946	RS1/10S473J	Not used
C257, 258	CCSQCH221J50	Not used
C271	CEJA220M10	Not used

DEH-68,635,58,535,53

Symbol & Description	Part No.	
	DEH-68/UC	DEH-535/UC
C272	CEJA101M10	Not used
C273	CKSQYB472K50	Not used
C274, 284	CEJA4R7M35	Not used
C275	CEJANP220M10	Not used
C276	CKSQYB222K50	Not used
C277	CKSQYB183K50	Not used
C278, 852, 858	CKSQYB473K50	Not used
C279	CKSQYB273K50	Not used
C280, 853	CKSYB103K50	Not used
C281	CKSQYB223K50	Not used
C282	CKSQYB153K50	Not used
C291, 705, 709, 855	CKSQYB103K50	Not used
C701	CKSYB224K16	Not used
C710	CASA1R0M16	Not used
C751	CEJA100M16	Not used
C856	CKSQYB103K50	Not used
C857	CKSQYB103K50	Not used
C931	CKSYB103K50	Not used

Symbol & Description	Part No.	
	DEH-68/UC	DEH-53/UC
R285	RS1/10S105J	Not used
R291, 602, 603, 604	RS1/10S473J	Not used
R304	RS1/10S104J	Not used
R608, 609, 713, 714	RS1/10S473J	Not used
R616	Not used	RS1/10S473J
R618, 710, 867, 869	RS1/10S473J	Not used
R624	RS1/10S104J	RS1/10S333J
R625	RS1/10S333J	RS1/10S473J
R630	RS1/10S202J	Not used
R631, 866	RS1/10S102J	Not used
R701, 702	RS1/10S681J	Not used
R704	RS1/10S105J	Not used
R706	RS1/10S681J	Not used
R707, 708	RS1/10S681J	Not used
R715, 716, 717, 868	RS1/10S473J	Not used
R728	RA3C473J	Not used
R751	RS1/10S0R0J	Not used
R851	RS1/8S331J	Not used
R853, 860, 865	RS1/10S103J	Not used
R854	RS1/10S303J	Not used
R856	RS1/10S163J	Not used
R858	RS1/10S163J	Not used
R861	RS1/10S103J	Not used
R862, 863, 864	RD1/4PU102J	Not used
R933	RS1/10S472J	Not used
R934	RD1/4PU272J	Not used
R943	RS1/8S471J	Not used
R946	RS1/10S473J	Not used
C251, 252, 274, 284	CEJA4R7M35	Not used
C255, 256, 257, 258	CCSQCH221J50	Not used
C271	CEJA220M10	Not used
C272	CEJA101M10	Not used
C273	CKSQYB472K50	Not used
C275	CEJANP220M10	Not used
C276	CKSQYB222K50	Not used
C277	CKSQYB183K50	Not used
C278, 852, 858	CKSQYB473K50	Not used
C279	CKSQYB273K50	Not used
C280, 853	CKSYB103K50	Not used
C281	CKSQYB223K50	Not used
C282	CKSQYB153K50	Not used
C291, 705, 709, 855	CKSQYB103K50	Not used
C301, 302, 751	CEJA100M16	Not used
C701	CKSYB224K16	Not used
C710	CASA1R0M16	Not used
C856	CKSQYB103K50	Not used
C857	CKSQYB103K50	Not used
C931	CKSYB103K50	Not used

Symbol & Description	Part No.	
	DEH-68/UC	DEH-53/UC
IC271 IC	M5282FP	Not used
IC272 IC	MC14052BF	Not used
IC273 IC	NJM2068MD	Not used
IC601 IC	PD4808B	PD4721B
IC701 IC	PD6194A	Not used
IC751 IC	PD8027A	Not used
IC851 IC	TPD1018F	Not used
Q251, 252, 302 Transistor	IMH3A	Not used
Q254 Transistor	IMD2A	Not used
Q301 Transistor	DTA124EK	Not used
Q601 Transistor	DTC114EK	Not used
Q851 Transistor	IMD2A	Not used
Q852 Transistor	DTC143EK	Not used
Q853 Transistor	DTC123EK	Not used
Q854 Transistor	DTC123EK	Not used
Q931 Transistor	2SB1243	Not used
Q932 Transistor	DTC114EK	Not used
Q941 Transistor	DTA144TK	Not used
D252 Diode	1SS133	Not used
D851 LED	BR4361F	Not used
D858, 860, 933, 934 Diode	ERA15-02VH	Not used
L701 Inductor	LAU100K	Not used
L751 Ferri-Inductor	LAU2R2K	Not used
X701 Radiator	CSS1338	Not used
S941 Switch	CSG1046	Not used
BZ601 Buzzer	CPV1011	Not used
R251, 252	RS1/10S821J	Not used
R253, 254, 705	RS1/10S681J	Not used
R255, 256, 257, 258	RS1/10S223J	Not used
R259	Not used	RS1/10S681J
R260	RS1/10S821J	RS1/10S681J
R261, 262, 264, 617	RS1/10S0R0J	Not used
R263, 267, 703	RS1/10S0R0J	Not used
R265	Not used	RS1/10S223J
R268, 269	Not used	RS1/10S0R0J
R271, 272	RS1/10S183J	Not used
R273, 277, 278, 852	RS1/10S103J	Not used
R274	RS1/10S243J	Not used
R275	RS1/10S683J	Not used
R279, 281, 283, 303	RS1/10S104J	Not used
R280, 282, 284	RS1/10S104J	Not used

DEH-68,635,58,535,53

====Circuit Symbol & No.====Part Name Part No.

C Unit Number :
Unit Name : Keyboard Unit

MISCELLANEOUS

IC 1801	IC	PD6196A
IC 1802	HIC Module	RS-140
D 1801	Diode	DA204K
D 1802	Diode	DA204K
D 1821	LED	CL220PGC
D 1822	LED	CL220PGC
D 1824	LED	CL170PGCD
D 1825	LED	CL170PGCD
D 1826	LED	CL170PGCD
D 1827	LED	CL170PGCD
D 1828	LED	CL170PGCD
D 1829	LED	CL170PGCD
D 1830	LED	CL170PGCD
D 1831	LED	CL170PGCD
X 1801	Ceramic Resonator 4.97MHz	CSS1312
S 1801	Push Switch	CSG1085
S 1802	Push Switch	CSG1086
S 1803	Push Switch	CSG1085
S 1804	Push Switch	CSG1084
S 1805	Push Switch	CSG1086
S 1806	Push Switch	CSG1084
S 1807	Push Switch	CSG1061
S 1808	Push Switch	CSG1061
S 1809	Push Switch	CSG1085
S 1810	Push Switch	CSG1086
S 1811	Push Switch	CSG1085
S 1812	Push Switch	CSG1086
S 1813	Push Switch	CSG1061
S 1814	Push Switch	CSG1061
S 1815	Push Switch	CSG1084
S 1816	Push Switch	CSG1085
S 1817	Push Switch	CSG1086
S 1818	Push Switch	CSG1061
S 1819	Push Switch	CSG1061
S 1820	Push Switch	CSG1084
S 1821	Push Switch	CSG1084
IL 1801	EL LCD	CEL1489 CAW1393

RESISTORS

R 1801	RS1/8S222J
R 1802	RS1/8S222J
R 1803	RS1/10S472J
R 1804	RS1/10S121J
R 1805	RS1/10S2R2J
R 1806	RS1/8S102J
R 1807	RS1/8S102J
R 1812	See Contrast table
R 1813	See Contrast table
R 1814	See Contrast table
R 1815	See Contrast table
R 1816	See Contrast table
R 1821	RS1/8S0R0J
R 1822	RS1/8S151J
R 1825	RS1/8S101J
R 1825	RS1/8S151J
R 1826	RS1/8S101J
R 1827	RS1/8S101J
R 1828	RS1/8S101J
R 1829	RS1/8S151J
R 1830	RS1/8S101J

====Circuit Symbol & No.====Part Name Part No.

R 1833	RS1/8S151J
R 1834	RS1/8S101J
R 1835	RS1/8S101J
R 1836	RS1/8S101J
R 1837	RS1/8S101J
R 1838	RS1/8S101J
R 1839	RS1/8S101J
R 1840	RS1/8S101J
R 1841	RS1/8S101J
R 1842	RS1/8S101J
R 1843	RS1/8S101J
R 1844	RS1/8S101J
R 1845	RS1/8S102J
R 1846	RS1/8S102J
R 1847	RS1/8S102J
R 1848	RS1/8S102J
R 1849	RS1/8S102J
R 1850	RS1/8S102J
R 1851	RS1/8S102J
R 1852	RS1/8S102J

CAPACITORS

C 1801	CKSQYB104K50
C 1803	CEV100M16

CONTRAST TABLE of KEYBOARD UNIT

DEH-68/UC, DEH-635/UC, DEH-58/UC, DEH-535/UC and DEH-53/UC have the same construction except for the following:

Symbol & Description	Part No.	
	DEH-68/UC DEH-635/UC	DEH-58/UC
R1812	RS1/10S0R0J	Not used
R1813	Not used	RS1/10S0R0J
R1814	Not used	RS1/10S102J
R1815	RS1/10S102J	Not used

Symbol & Description	Part No.	
	DEH-68/UC DEH-635/UC	DEH-535/UC
R1812	RS1/10S0R0J	Not used
R1813	Not used	RS1/10S0R0J
R1814	Not used	RS1/10S102J
R1815	RS1/10S102J	Not used

Symbol & Description	Part No.	
	DEH-68/UC DEH-635/UC	DEH-53/UC
R1812	RS1/10S0R0J	Not used
R1813	Not used	RS1/10S0R0J
R1814	Not used	RS1/10S102J
R1815	RS1/10S102J	Not used

D Unit Number :
Unit Name : Detector PCB

Q 1	Photo-transistor	CPT-230S-X
Q 2	Photo-transistor	CPT-230S-X

Miscellaneous Parts List

M	1	Pickup Unit(Service)	CXX1230
M	1	Motor Unit(Spindle)	CXA8912
M	2	CRG Motor Unit(Carriage)	CXA8986
M	3	Load Motor Unit>Loading)	CXA8702

6. ADJUSTMENT

6.1 TUNER ADJUSTMENT

● Connection Diagram

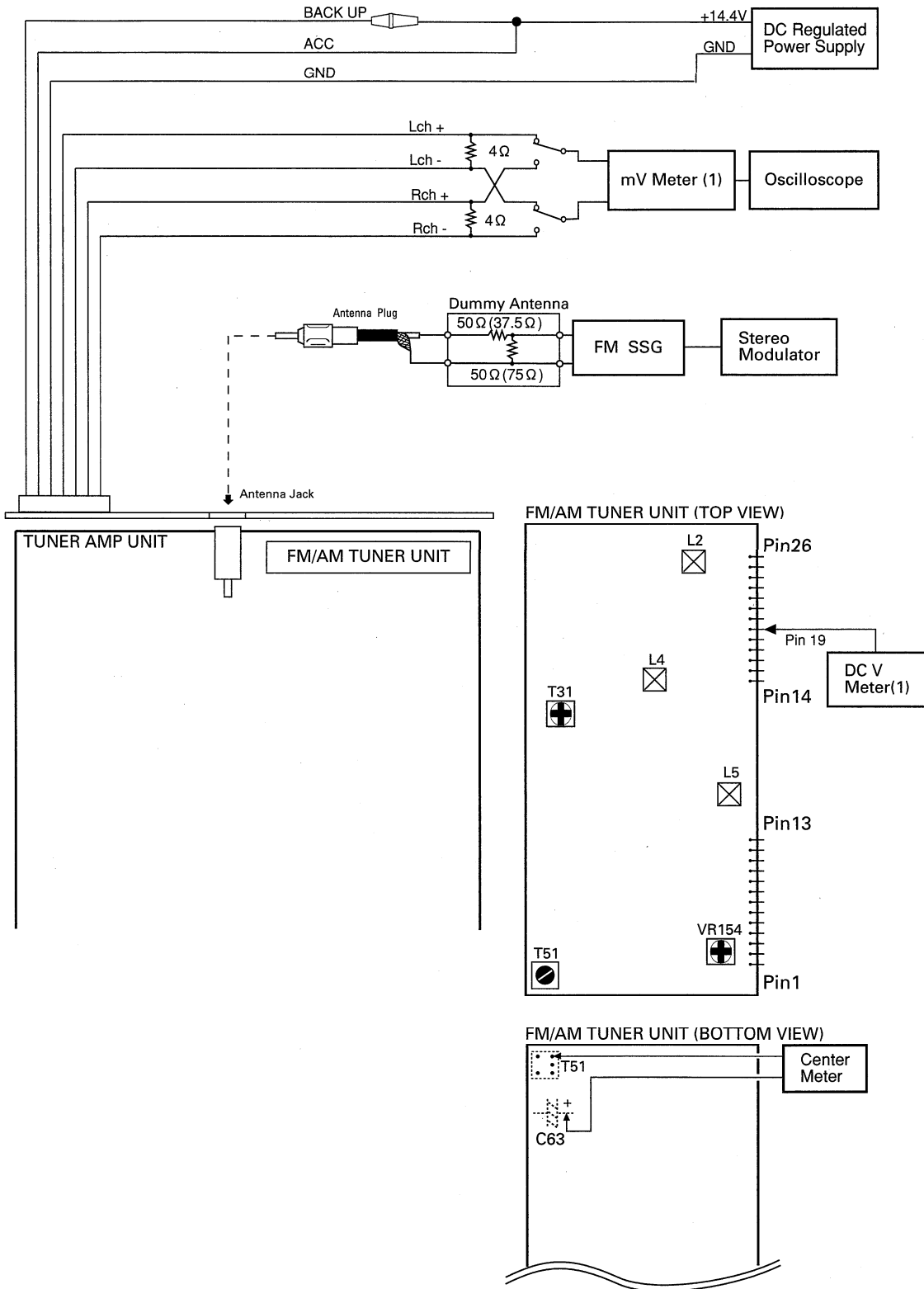

Fig. 25

DEH-68,635,58,535,53

FM ADJUSTMENT

Modulation M: MONO MOD., 400Hz 30%(22.5kHz Dev.)

S: STEREO MOD., 1kHz, L or R=30%(20.25kHz+7.5kHz Dev.)

NOTE: Before proceeding to further adjustments after switching power ON, let the tuner run for ten minutes to allow the circuits to stabilize.

	No.	FM SSG		Displayed	Adjustment Point	Adjustment Method (Switch Position)
		Frequency(MHz)	Level(dBf)	Frequency(MHz)		
TUN Volt	1	108.0	L5	DC V Meter(1) : 6V
IF	1	98.1 M	60	98.1	T51	Center Meter : 0
ANT Coil	1	98.1 M	5	98.1	L2	mV Meter(1) : Maximum
RF Coil	1	98.1 M	5	98.1	L4	mV Meter(1) : Maximum
IFT	1	98.1 M	5	98.1	T31	mV Meter(1) : Maximum (STEREO MODE)
ARC	1	98.1 S	39	98.1	VR154	mV Meter(1) : Separation 5dB (STEREO MODE)

6.2 CHECKING THE GRATING

● Checking the Grating After Changing the Service Pickup Unit

·Note :

Unlike previous CD mechanism modules the grating angle of the Pickup unit cannot be adjusted after the Pickup unit is changed. The Pickup unit in the CD mechanism module is adjusted on the production line to match the CD mechanism module and is thus the best adjusted Pickup unit for the CD mechanism module. Changing the Pickup unit is thus best considered as a last resort. However, if the Pickup unit must be changed, the grating should be checked using the procedure below.

·Purpose :

To check that the grating is within an acceptable range.

·Symptoms of Mal-adjustment :

If the grating is off by a large amount symptoms such as being unable to close tracking, being unable to perform track search operations, or track searching taking a long time, may appear.

·Method :

- | | |
|----------------------|---------------------------|
| ·Measuring Equipment | ·Oscilloscope, Two L.P.F. |
| ·Measuring Points | ·E, F, REFOUT |
| ·Disc | ·ABEX TCD-784 |
| ·Mode | ·TEST MODE |

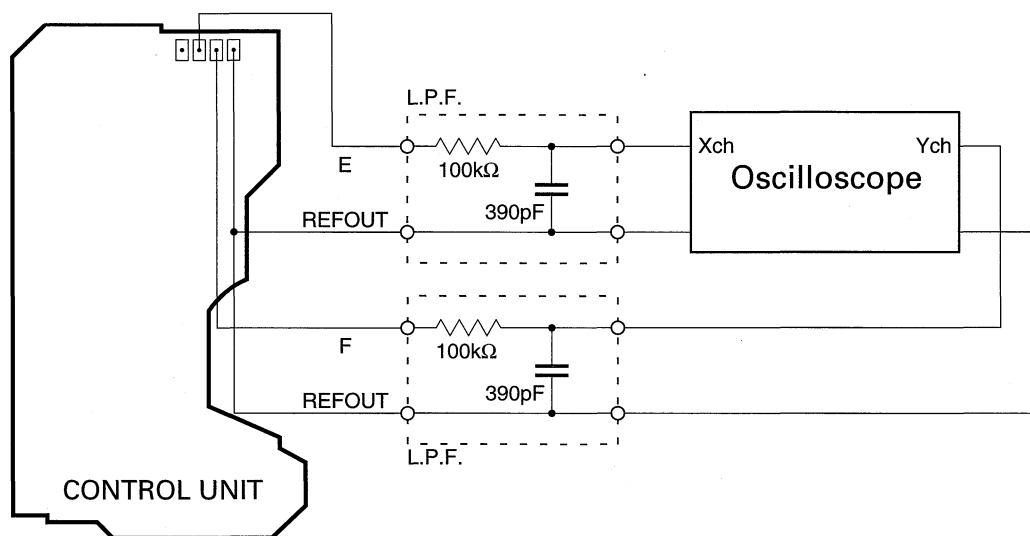

·Checking Procedure

1. In test mode, load the disc and switch the 5V regulator on.
2. Using the → and ← buttons, move the Pickup unit to the innermost track.
3. Press key 3 to close focus, the display should read "91". Press key 2 to implement the tracking balance adjustment the display should now read "81". Press key 3 4 times. The display will change, returning to "81" on the fourth press.
4. As shown in the diagram above, monitor the LPF outputs using the oscilloscope and check that the phase difference is within 75°. Refer to the photographs supplied to determine the phase angle.
5. If the phase difference is determined to be greater than 75° try changing the Pickup unit to see if there is any improvement. If, after trying this a number of times, the grating angle does not become less than 75° then the mechanism should be judged to be at fault.

·Note

Because of eccentricity in the disc and a slight misalignment of the clamping center the grating waveform may be seen to "wobble" (the phase difference changes as the disc rotates). The angle specified above indicates the average angle.

·Hint

Reloading the disc changes the clamp position and may decrease the "wobble".

DEH-68,635,58,535,53

Grating waveform

Ech → Xch 20mV/div, AC
Fch → Ych 20mV/div, AC

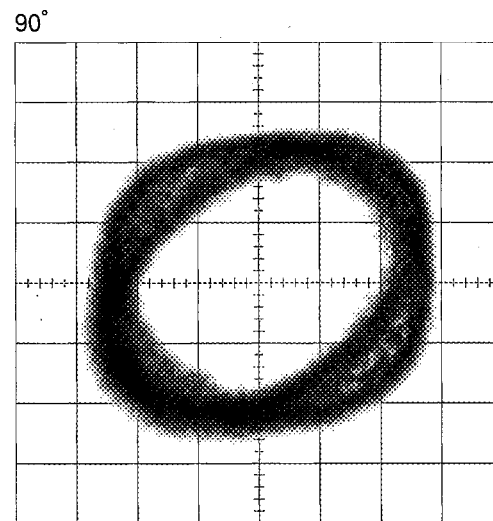
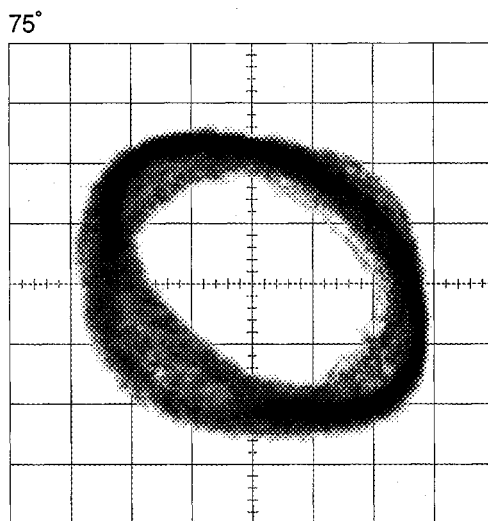
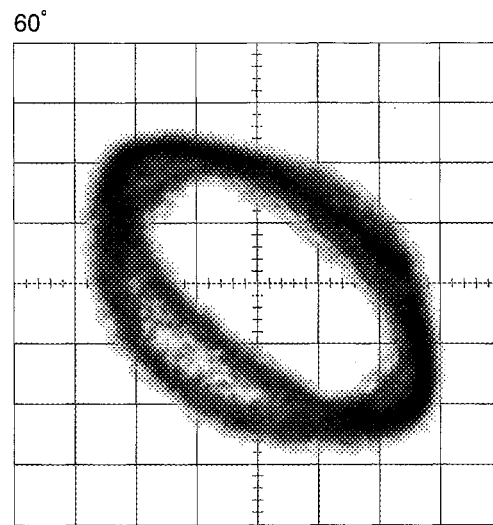
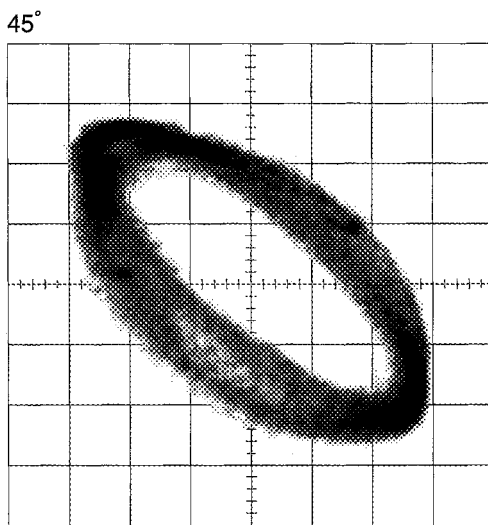
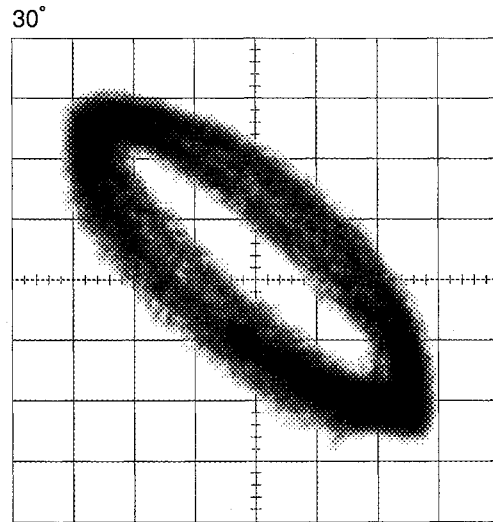
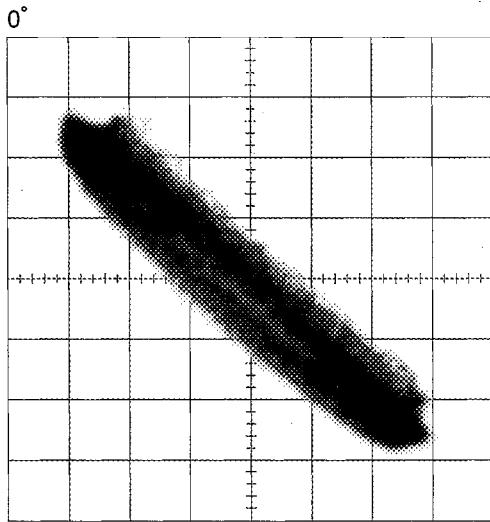

7. GENERAL INFORMATION

7.1 PARTS

7.1.1 IC

PA4023B

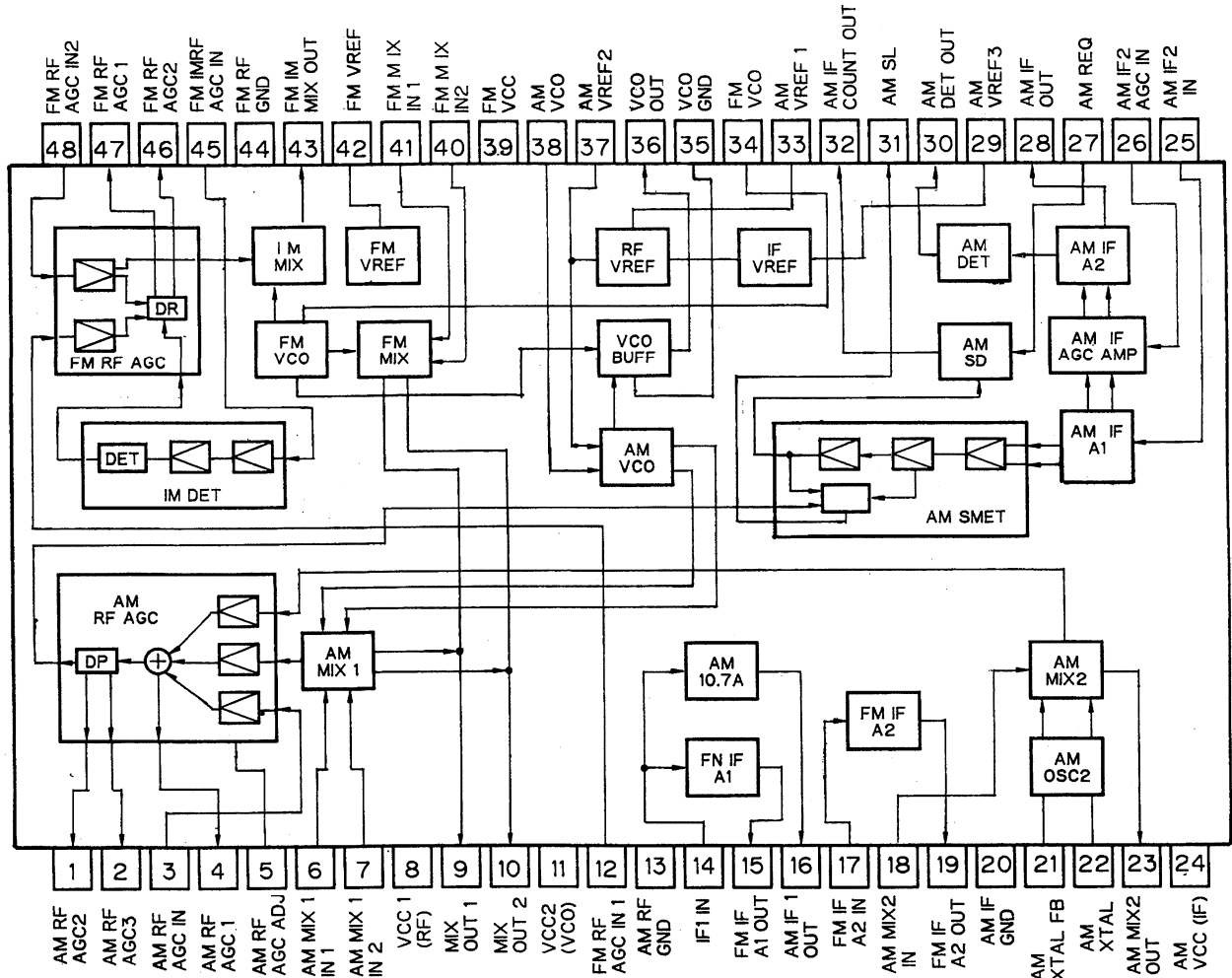

● Pin Functions (UPC2572GS)

Pin No.	Pin Name	I/O	Function and Operation
1	EFM-IN	I	EFM comparator input
2	AGC-OUT	O	AGC amplifier output
3	C. AGC		Connects AGC peak detection condenser
4	RF-IN	I	RF signal DC component cut input
5	RF-OUT	O	RF amplifier output
6	RF-	I	RF amplifier inverted input
7	C1, 3T		Connects RF3T component detection condenser
8	C2, 3T		Connects RF3T component detection condenser
9	Vcc		Power supply
10	A	I	A signal input
11	C	I	C signal input
12	B	I	B signal input
13	D	I	D signal input
14	F	I	F signal input
15	E	I	E signal input
16	PD	I	APC amplifier input
17	LD	O	APC amplifier output

DEH-68,635,58,535,53

Pin No.	Pin Name	I/O	Function and Operation
18	LDON	I	Laser diode ON/OFF input
19	VREF-OUT	O	Reference voltage output
20	VREF-IN	I	Reference voltage input
21	DET-OUT	O	Vibration detection circuit output
22	DET-IN	I	Vibration detection circuit input
23	TE-OUT2	O	Tracking error amplifier output (fourfold gain)
24	TE-OUT1	O	Tracking error amplifier output (singlefold gain)
25	TE-	I	Tracking error amplifier inverted input
26	GND		GND
27	FE-	I	Focus error amplifier inverted input
28	FE-OUT	O	Focus error amplifier output
29	C.FE	I	Focus error signal DC component cut input
30	3T-OUT	O	RF3T component output
31	MIRR	O	MIRR signal output
32	RFOK	O	RFOK signal output
33	DEFECT	O	DEFECT signal output
34	C. DEF		Connects DEFECT signal detection condenser
35	EFM-OUT	O	EFM comparator output
36	ASY	I	EFM comparator level input
37	TE-BAL	I	Tracking balance control
38	FE-BAL	I	Focus balance control

UPC2572GS

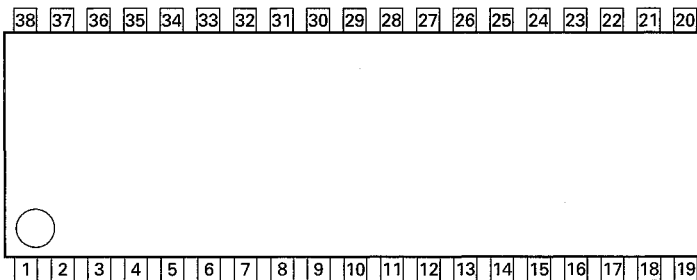

IC's marked by* are MOS type.

Be careful in handling them because they are very liable to be damaged by electrostatic induction.

*UPD63702GF

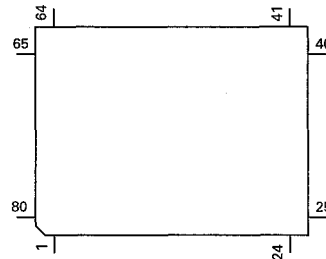

● Pin Functions (UPD63702GF)

Pin No.	Pin Name	I/O	Function and Operation
1	D.VDD		Supplies current of positive voltage to the logic circuits
2	RST	I	System reset input pin
3	AO	I	Microcomputer interface AO="L": STB active and set to address register AO="H": STB active and set to parameter
4	STB	I	Signal to latch serial data within the LSI
5	SCK	I	Clock input pin to input and output serial data
6	SO	O	Outputs serial data and status signal
7	SI	I	Serial data input pin
8	D.GND		Logic circuit GND
9	X.GND		Crystal oscillation circuit GND
10	XTAL	I	Crystal oscillator connection pin
11	XTAL	O	Crystal oscillator connection pin
12	X.VDD		Supplies current of positive voltage to the crystal oscillation circuit
13	DA.VDD		Supplies current of positive voltage to the D/A converter
14	R+	O	Right channel analog audio data output pin
15	R-	O	Right channel analog audio data output pin
16,17	DA.GND		D/A converter GND
18	L-	O	Left channel analog audio data output pin
19	L+	O	Left channel analog audio data output pin
20	DA.VDD		Supplies current of positive voltage to the D/A converter
21	D.VDD		Supplies current of positive voltage to logic circuit

Pin No.	Pin Name	I/O	Function and Operation
22	FLAG	O	Flag output pin to indicate that audio data currently being output consists of noncorrectable data
23	WDCK	O	Pin to output double the frequency of LRCK
24	C16M	O	Pin to output the clock
25	EMPH	O	Output pin for the pre-emphasis data in the sub-Q code
26	DIN	I	Input pin for serial audio data
27	DOUT	O	Output pin for the serial audio data
28	SCKO	O	Output pin for the clock for the serial audio data
29	LRCK	O	Signals to distinguish the right and left channels of the audio data output from DOUT. Frequency is 44.1kHz at 50% duty at normal regeneration
30	TX	O	Output pin for the digital audio interface data
31	CTLV	I	Oscillation control pin for high-frequency clock generation VCO used for the digital PLL upon regeneration at fast speed of 2- or 4-fold
32	POUT	O	Output point for phase comparison
33	D.GND		GND for the logic circuit
34	VCO	I	Input pin for the inverter
35	\overline{VCO}	O	Output pin for the inverter
36	D.VDD		Supplies current of positive voltage to the logic circuit
37	PLCK	O	Pin for monitoring the bit clock
38	LOCK	O	Indicates "H" when the synchronized pattern detection signal matches the frame counter output at the EFM recovery modulation, and "L" when they don't match
39	WFCK	O	Minute-cycle signal for the bit clock, the signal indicates the cycle of 1 frame (approx. 7.35kHz)
40	RFCK	O	Minute-cycle signal for the clock, the signal indicates cycle of 1 frame (approx. 7.35kHz)
41	D.GND		GND for the logic circuit
42,43	TEST0,1	I	Test pins
44,45	TM2, TM4	I	Pins for controlling regeneration at fast speed of 2- or 4-fold
46-49	T4-T7	I	Test pins
50,51	C1D1, C1D2	O	Output pin for indicating the C1 error correction results
52-54	C2D1-C2D3	O	Output pin for indicating the C2 error correction results
55	D.VDD		Supplies current of positive voltage to the logic circuit
56	SFSY	O	Outputs 1 word of the subcode. Generally, 1 cycle is approx 136 micro seconds
57	SBSY	O	The signal indicates the beginning of the subcode block. The SFSY signal is output at high level every 98 times
58	SBSO	O	Output pin for the subcode data
59	SBCK	I	Input pin for the clock signal for read-out of the subcode data
60	A.GND		GND for the analog circuit
61	MD	O	Output pin for the spindle drive
62	SD	O	Output pin for the sled drive
63	TD	O	Output pin for the tracking drive
64	FD	O	Output pin for the focus drive
65	FBAL	O	Output pin for the focus balance control
66	TBAL	O	Output pin for the tracking balance control
67	A.VDD		Supplies current of positive voltage to the analog circuit
68	TBC	I	Switches coefficient banks for the tracking filter
69	EFM	I	Input pin for the EFM signal
70	HOLD	I	Input pin for the hold control signal
71	RFOK	I	Input pin for the RFOK signal
72	MIRR	I	Input pin for the MIRR signal
73	A.GND		GND for the analog circuit
74	HOME	I	Home position detector input
75	VR1	I	The signal input through these pins is digitized to 8-bit by the A/D converter, which by operation of the assigned register, can be read into the microcomputer
76	FE	I	Inputs a focus-error signal from the RF amplifier
77	TE	I	Inputs a tracking-error signal from the RF amplifier
78	TEC	I	Input pin for the tracking comparator
79	REFOUT	O	Output point for midpoint potential for the A/D converter for the LSI portion
80	A.VDD		Supplies current of accurate voltage to the analog circuit

DEH-68,635,58,535,53

XLA6997FP

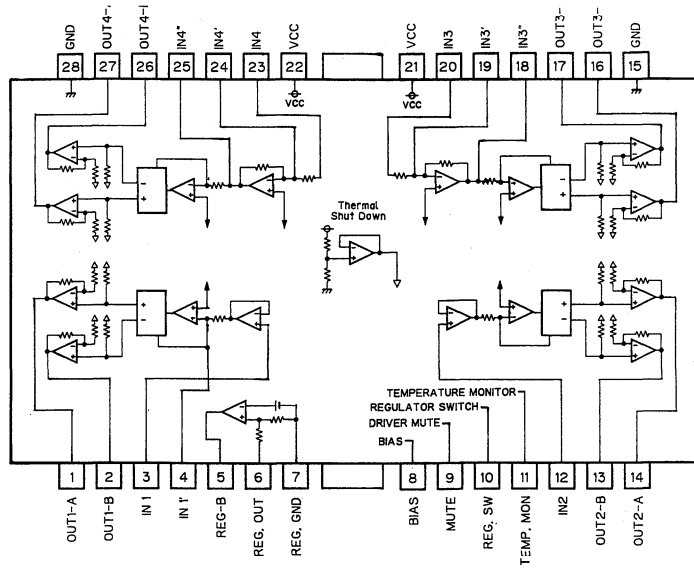

XLA6285FP

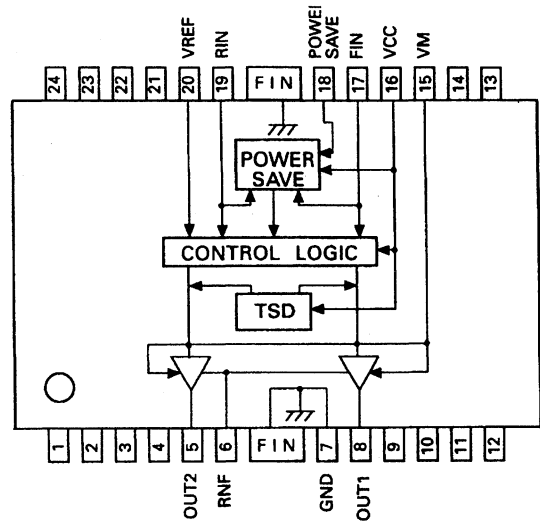

*SN761027DL

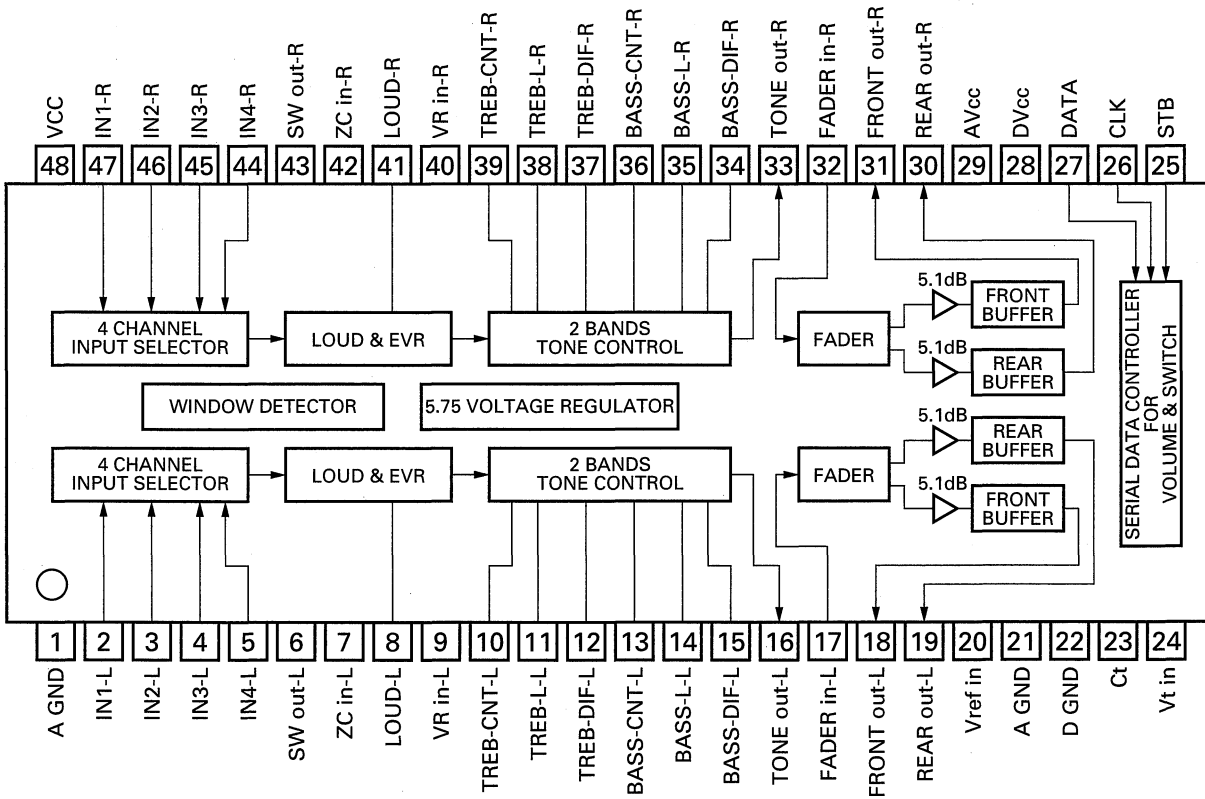

TDA7386

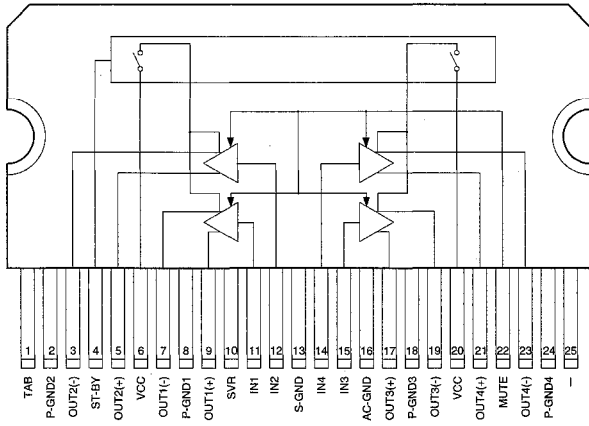

PM2005B

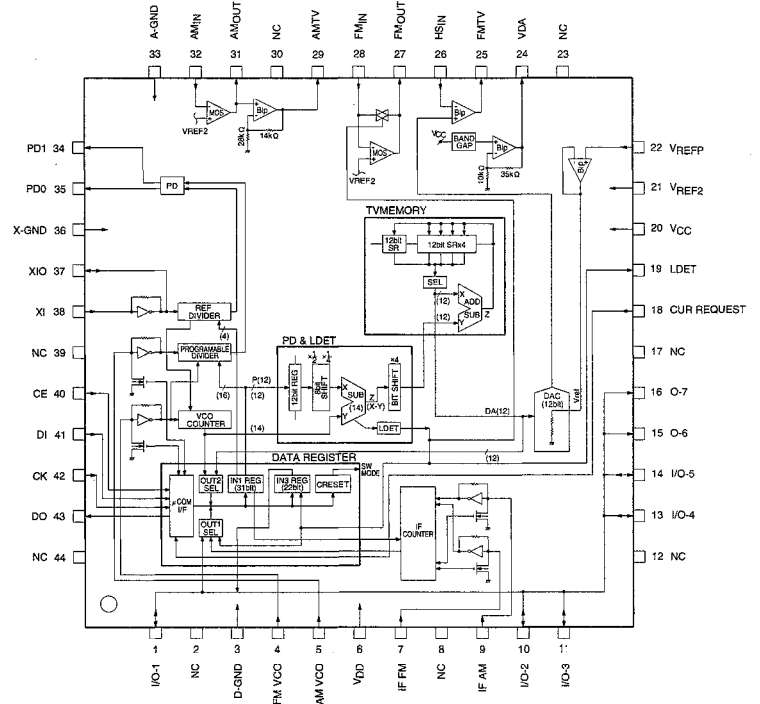

● Pin Functions (PD4808B, PD4721B)

Pin No.	Pin Name	I/O	Format	Function and Operation
1	DSCSNS	I		Disc insertion detection input
2	ST	I		Stereo input
3	ISENS	I		Illumination sensor input
4	AVSS			Connect to GND.
5	VCAOUT	O		Analog output for SUBW electronic volume control
6	SD	I		SD signal input
7	AVREF1			Connect to VDD.
8	KYDT	I		Grille microprocessor communications data input
9	DPDT	O	C	Grille microprocessor communications data output
10	SWVDD	O	C	Grille power output
11	RIDDI	I		RDS/ID logic communications data input
12	RIDDO	O	C	RDS/ID logic communications data output
13	RIDCK	O	C	RDS/ID logic communications clock output
14	RIDRST	O	C	RDS/ID logic reset output
15	RIDSEL	O	C	RDS/ID logic select output
16	XSI	I		Serial data input to CD LSI
17	XSO	O	C	Serial data output to CD LSI
18	XSCK	O	C	Serial clock output to CD LSI
19	XSTB	O	C	CD LSI strobe output
20	CD5VON	O	C	CD (5 V) power control output
21	XAO	O	C	CD LSI command/data control output
22	XRST	O	C	CD LSI reset control output
23	CONT	O	C	Servo driver power control output
24	VDCONT	O	C	VD power control output
25	DIMMER	O	C	Dimmer control output
26	CDEJET	O	C	Load Motor Eject control output
27	CDLOAD	O	C	Load Motor Load control output
28	LOCK	I		Spindle lock detection input
29	FOK	I		Focus OK input
30	DRELAY	O	C	Output for external relay

DEH-68,635,58,535,53

Pin No.	Pin Name	I/O	Format	Function and Operation
31	DRSENS	I		Door open/closed sensor input
32	DRSYS	O	C	Door system change output
33	VSS			(GND)
34	CLAMP	I		Disc clamp
35	FIEOUT	O	C	FIE ON/OFF control output
36	SUBW0	O	N	Subwoofer cutoff frequency selection output 0
37	SUBW1	O	N	Subwoofer cutoff frequency selection output 1
38	TMUTE	O	N	Tuner mute output
39	DLED	O	N	LED output for alarm
40	MIRR	I		Mirror surface detection input
41	VST	O	C	Electronic VOL strobe output
42	VCK	O	C	Electronic VOL clock output
43	VDT	O	C	Electronic VOL data output
44	ILMPW	O	C	Illumination power output
45	PEE	O	C	PEE ON oscillation output
46	MUTE	O	C	General mute output
47	SYSPW	O	C	System power output
48	TUNPCK	O	C	PLL IC clock
49	TUNPDO	O	C	PLL IC data output
50	TUNPCE	O	C	PLL IC chip enable
51	TUNPDI	I		PLL IC data input
52	MODEL2	I		Destination selection 2
53	LCDPW	O	C	LCD backlight power output
54	FM	O	C	FM output
55	AM	O	C	AM output
56	SUBWMUTE	O	C	Subwoofer mute output
57	DLSSENS	I		Centralized door lock release sensor input
58	STOUT	O	C	Output for starter motor cutoff
59	TUNANT	O	C	Tuner power output
60	RESET			Reset
61	RIDRDY	I		RDS/ID logic ready input
62	BSENS	I		Backup input
63	ASENS	I		ACC sensor input
64	DSSENS	I		Detachment sensor input
65	MOSENS	I		Motion/window damage sensor input
66	CLKIN	I	C	8 Hz clock input for clock
67	CDPW	O	C	CD power control output
68	VDD			VDD
69	X2			Oscillator output
70	X1			Oscillator input
71	IC			Connect to GND.
72	XT2			Subclock terminal
73	TESTIN	I		Test mode
74	AVDD			Analog power supply of A/D convertor
75	AVREF0			Reference voltage input of A/D convertor
76	SL	I		Signal level input
77	MODEL1	I		Destination identification 1
78	VDSSENS	I		VD power top/ground fault sensor input
79	TEMP	I		Temperature sensor input
80	EJTSNS	I		Disc Eject position detection input

*PD4808B, PD4721B

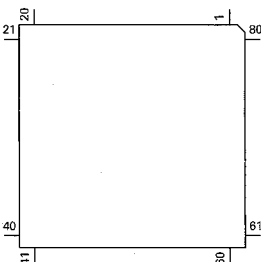

Format	Meaning
C	C MOS
N	N channel open drain

● Pin Functions (PD6194A)

Pin No.	Pin Name	I/O	Format	Function and Operation
1-8	NC	O	N	Not used
9	\overline{OE}	O	N	ROM output control
10	\overline{ROMEN}	O	N	ROM enable
11	ADD17	O	N	ROM address #17
12	AVCC			5V power supply input
13	AVR			5V power supply input
14	AVSS			Connect to GND
15	\overline{IRSEL}	I		Select input
16-19	NC	I		Not used
20	\overline{IRrst}	I		Reset input
21,22	MOD0,1			Connect to GND
23	XIN			Oscillator input
24	XOUT			Oscillatro output
25	VSS			Connect to GND
26-28	NC	O	C	Not used
29	IRRDY	O	C	Communications ready output
30-33	ADD16-13	O	C	Rom address #16-#13
34-41	ADD7-0	O	C	Rom address #7-#0
42-49	DT7-0	I		Rom data #7-#0 input
50	VSS			Connect to GND
51	TEST	I		Test program input
52	\overline{IRsck}	I		Communications clock input
53	IRDO	O	C	Communications data output
54	IRDI	I		Communications data input
55,56	NC	O	C	Not used
57	VCC			5V power supply input
58,59	NC	O	C	Not used
60-64	ADD8-12	O	N	ROM address #8-#12

*PD6194A

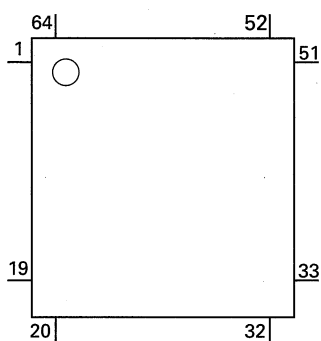

Format	Meaning
C	C MOS
N	N channel open drain

DEH-68,635,58,535,53

*PD8027A

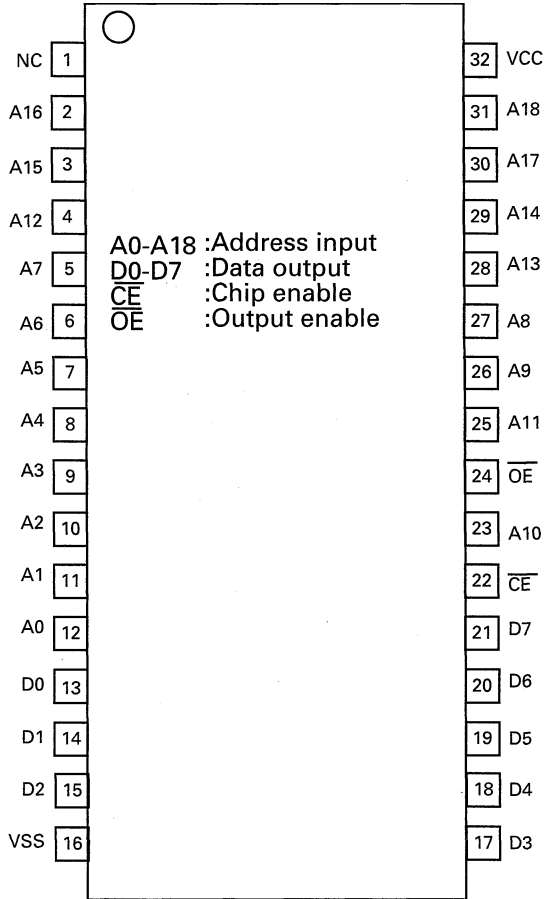

● Pin Functions (PD6196A)

Pin No.	Pin Name	I/O	Format	Function and Operation
1-5	SEG4-0	O		LCD segment output
6-9	COM3-0	O		LCD common output
10	V3			LCD driver power supply
11-14	KS4-1	O	N	Key strobe output
15,16	KD1,2	I		Key data input
17	REM	I		Remote-control input
18	SI	I		UART input
19	RST	I		System reset input
20	SO	O	C	UART output
21	MODA	I		Connect to VSS
22,23	X0,1			Connect to oscillator
24	VSS			GND
25,26	KD3,4	I		Key data input
27,28	KS6,5	O	N	Key strobe output
29-55	SEG39-13	O		LCD segment output
56	VCC	O		Power supply
57-64	SEG12-5	O		LCD segment output

DEH-68,635,58,535,53

*PD6196A

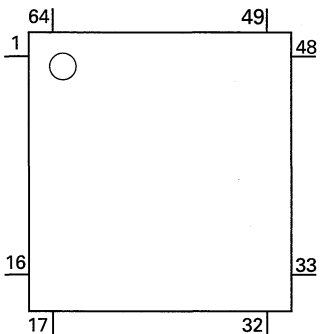

Format	Meaning
C	C MOS
N	N channel open drain

RS-140

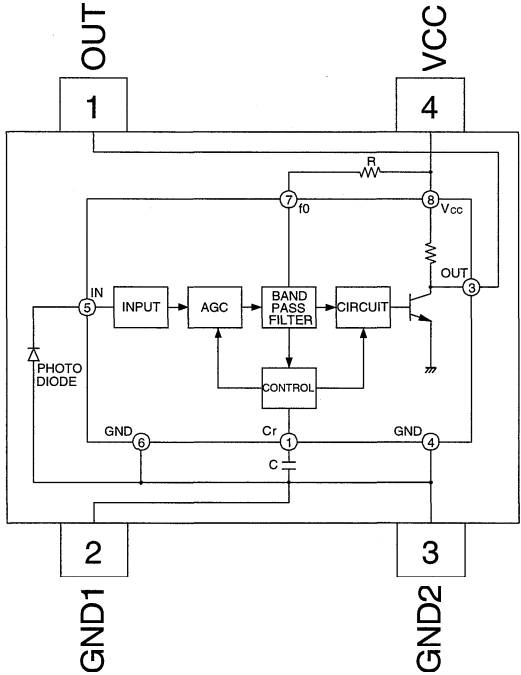

DEH-68,635,58,535,53

7.1.2 DISPLAY

● CAW1393

SEGMENT

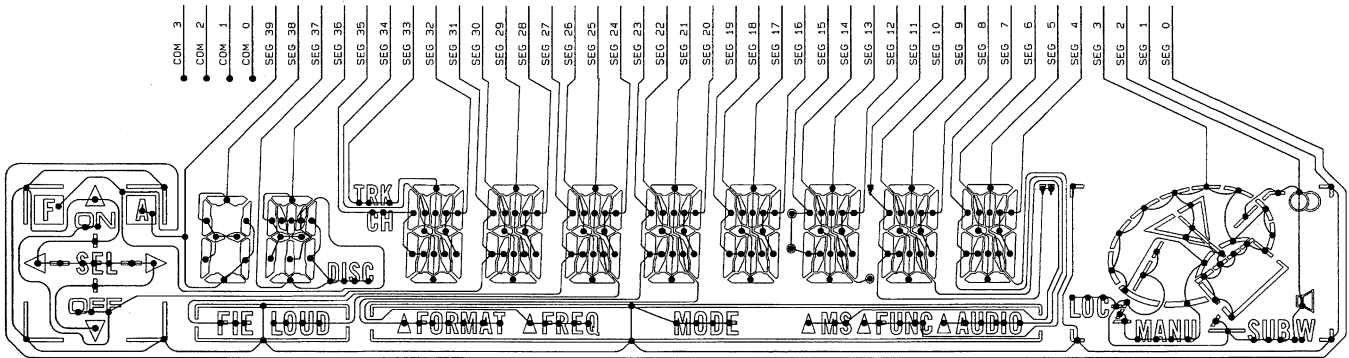

COMMON

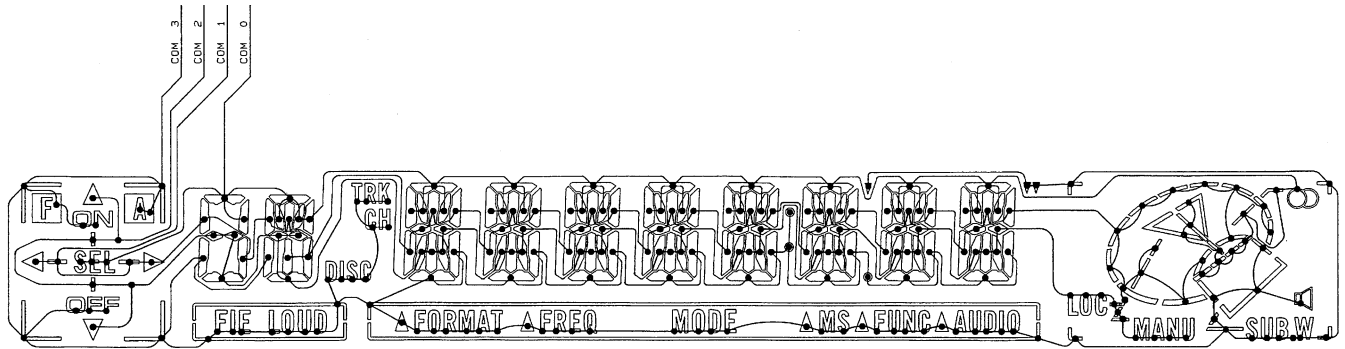

Fig. 26

7.2 DIAGNOSIS

7.2.1 DISASSEMBLY

● Removing the Case(Not shown)

- 1.Remove the two screws.
- 2.Insert and turn a flat screwdriver at locations indicated by arrows to remove the case.

● Removing the Detach Grille Assy(Fig.27)

- 1.Press the detach button, and then pull Detach Grille Assy.

● Removing the Panel Assy(Fig.27)

- 1.Disconnect the two stoppers indicated by arrows, and then remove the Panel Assy.

● Removing the CD Mechanism Module(Fig.27)

- 1.Remove the four screws.
- 2.Disconnect the connector.
- 3.Remove the CD Mechanism Module.

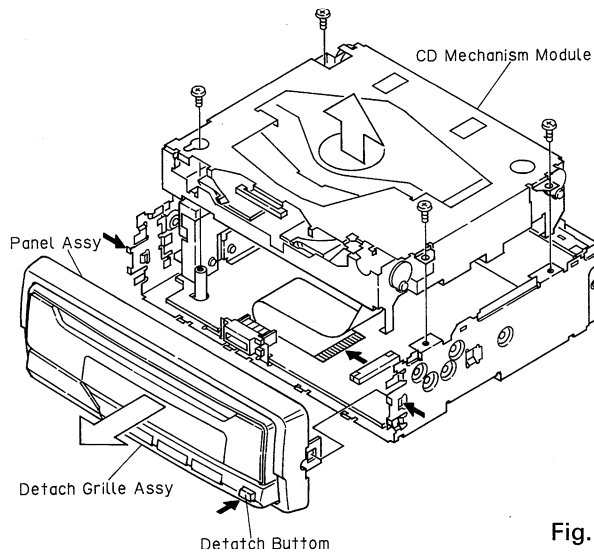

Fig. 27

● Removing the Chassis Unit(Fig.28)

- 1.Remove the two screws A, two screws B, screw C and screw D.
- 2.Stretch the three claws, and then remove the Chassis Unit.

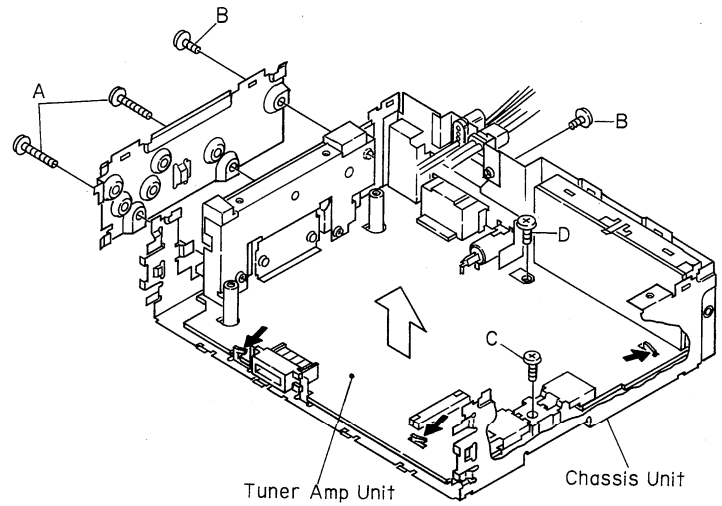

Fig. 28

7.2.2 TEST MODE

● CD Test Mode

1)Precautions

· This unit uses a single power supply (+5V) for the regulator. The signal reference potential, therefore, is connected to REFO(approx. 2.5V) instead of GND.

If REFO and GND are connected to each other by mistake during adjustments, not only will it be impossible to measure the potential correctly, but the servo will malfunction and a severe shock will be applied to the pick-up. To avoid this, take special note of the following.

Do not connect the negative probe of the measuring equipment to REFO and GND together. It is especially important not to connect the channel 1 negative probe of the oscilloscope to REFO with the channel 2 negative probe connected to GND.

Since the frame of the measuring instrument is usually at the same potential as the negative probe, change the frame of the measuring instrument to floating status.

If by accident REFO comes in contact with GND, immediately switch the regulator or power OFF.

· Always make sure the regulator is OFF when connecting and disconnecting the various filters and wiring required for measurements.

· Before proceeding to further adjustments and measurements after switching regulator ON, let the player run for about one minute to allow the circuits to stabilize.

· Since the protective systems in the unit's software are rendered inoperative in test mode, be very careful to avoid mechanical and /or electrical shocks to the system when making adjustment.

· Test mode starting procedure

Switch ACC, back-up ON while pressing the **4** and **6** keys together.

· Test mode cancellation
Switch ACC, back-up OFF.

· Disc detection during loading and eject operations is performed by means of a photo transistor in this unit. Consequently, if the inside of the unit is exposed to a strong light source when the outer casing is removed for repairs or adjustment, the following malfunctions may occur.

*During PLAY, even if the eject button is pressed, the disc will not be ejected and the unit will remain in the PLAY mode.

*The unit will not load a disc.

When the unit malfunctions this way, either re-position the light source, move the unit or cover the photo transistor.

· When loading and unloading discs during adjustment procedures, always wait for the disc to be properly clamped or ejected before pressing another key. Otherwise, there is a risk of the actuator being destroyed.

· Turn power off when pressing the button → or the button ← key for focus search in the test mode. (Or else lens may stick and the actuator may be damaged.)

· SINGLE/4TRK/10TRK/32TRK will continue to operate even after the key is released. Tracking is closed the moment C-MOVE is released.

· JUMP MODE resets to SINGLE as soon as power is switched OFF.

● Flow Chart

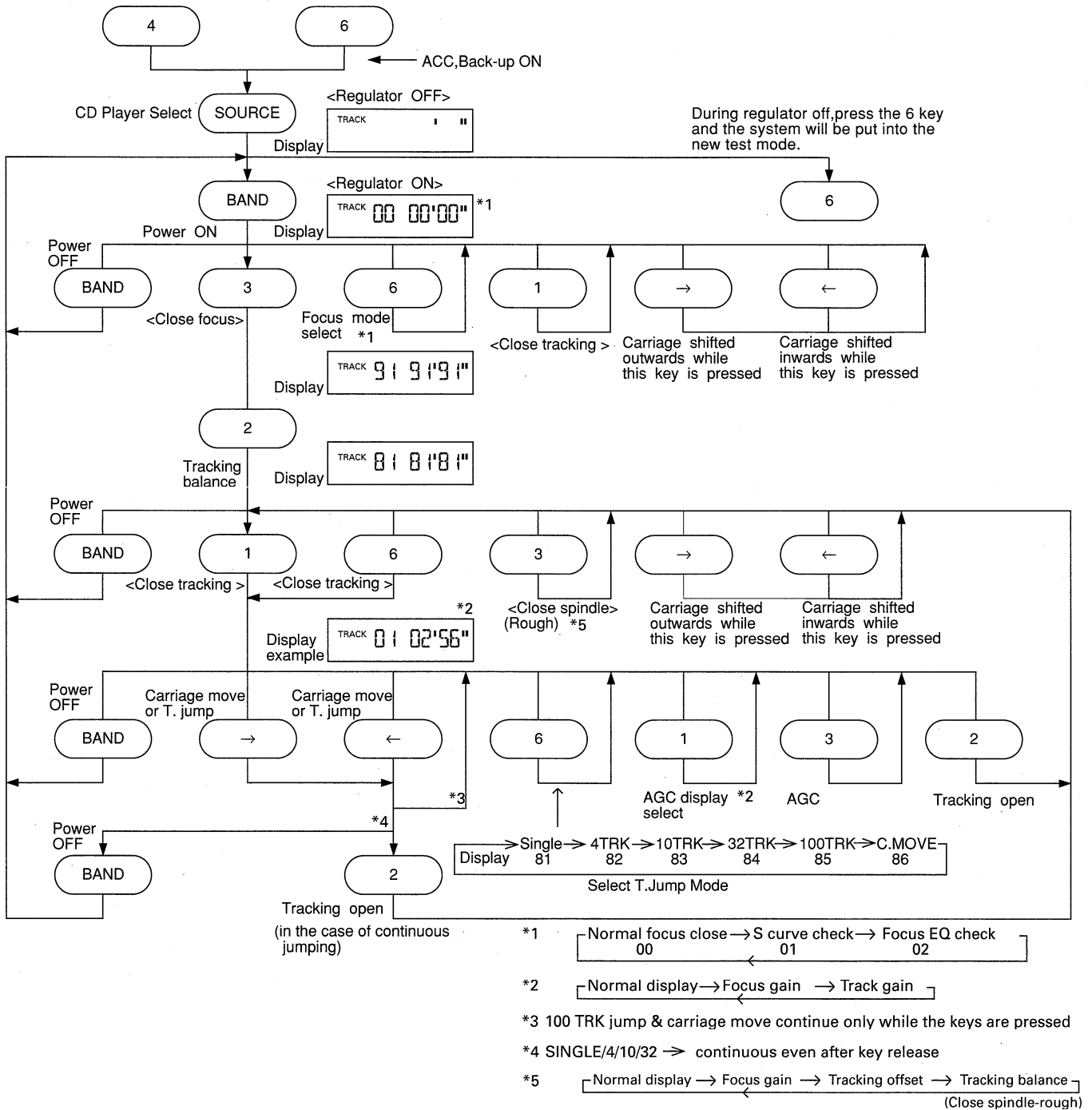

DEH-68,635,58,535,53

● Error Number Indication

If the CD should fail to operate or if an error has taken place during operation the player will enter into the error mode, and the cause of the error will be numerically indicated.

This is aimed at assisting in analysis or repair.

(1) Basic Means of Display

·With ERROR indicated in "MODE" on IP-BUS Display data, an error code is transmitted by the use of MIN and SEC.

The MIN and SEC data will be identical.

·Examples of Display ERROR-XX

(2) Error Codes

Error Code	Classification	Description	Cause/Detail
10	ELECTRIC	Carriage home failure	Carriage doesn't move to or from the innermost position →Home switch failed and/or carriage immobile
11	ELECTRIC	Focus failure	Focus failed →Defects, disc upside-down, severe vibration
12	ELECTRIC	SETUP failure Subcode failure	Spindle failed to lock or subcode unreadable →Spindle defective, defect, severe vibration
14	ELECTRIC	Mirror failure	Unrecorded CD-R The disc is upside-down, defects, vibration
17	ELECTRIC	Set up failure	AGC protect failed →Defects, disc upside-down, severe vibration
19	ELECTRIC	Set up failure	Tracking error waveform is too unbalanced (>50%) or level is too small →The P.U.unit or tracking error circuitry is N.G.
30	ELECTRIC	Search time out	Failed to reach target address →Carriage/tracking defective and/or defects
A0	SYSTEM	Power failure	Power overvoltage or short circuit detected →Switching transistor defective and/or power abnormal

"defects" means scratches, dirt etc on the surface of the disc.

● New Test Mode(aging operation and setup analysis)

The single CD player plays in normal mode. After being set up, it will display FOK (focus), LOCK (spindle), subcode, sound skip, protection against a mechanical error or the like, occurrence of an error, cause and time of an expiry, if any, (and disc number).

During the setup, the CD software operation status (internal RAM and C-point)is displayed.

(1) How to enter NEW TEST Mode

See the test mode flow chart Page 73.

(2) Relations of keys between TEST and NEW TEST Modes

Keys	Test Mode		New Test Mode	
	Regulator OFF	Regulator ON	PLAY in progress	Error Occurred, Protection Activated
BAND	Regulator ON	Regulator OFF	—	Time of occurrence / cause of error select
→	—	FWD-KICK	TRACK+ / FF	—
←	—	REV-KICK	TRACK- / REV	—
1	—	TRACKING CLOSE	SCAN	—
2	—	TRACKING OPEN	REPEAT	—
3	—	FOCUS CLOSE	RANDOM	—
6	To New Test Mode Select	FOCUS MODE	AUTO/MANU	—

Operations, such as EJECT, CD ON/OFF, etc. are performed normally.

(3) Error Cause (Error Number) Code

Error Code	Classification	Mode	Description	Cause	Detail
40	ELECTRIC	PLAY	FOK=L 100ms	Put out of focus	Scratch, Stain, Vibration, Servo defect, etc...
41	ELECTRIC	PLAY	LOCK=L 100ms	Spindle unlock	
42	ELECTRIC	PLAY	Subcode unacceptable 500ms	Failed to read subcode	
43	ELECTRIC	PLAY	Sound skipped	Last address memory operated	

(4) Indicating an Operation Status During Setup

Status No.	Description	Protection operation
01	Carriage home mode started	None
02	Carriage moving inwards	10-second time out, Home switch failed
03	Carriage moving outwards	10-second time out, Home switch failed
05	Carriage moving outwards	None
11	Setup started	None
12	Spindle turn/Focus search started	None
13	Waiting for focus closure (XSI=L)	Failure to close focus
10,14	Waiting for focus closure (FOK=H)	Failure to close focus
15, 16, 17	Focus closed, Tracking open	Focus disrupted
18	During focus AGC Subcode waiting	Focus disrupted
19	During tracking AGC	Disrupted focus
20	Waiting for MIRR, LOCK or subcode read Carriage closed, SPINDLE=ADAPTIVE	Focus disrupted, MIRR NG, Failure to lock, Failed to read subcode

(5) Example of Display.

·SET UP in progress

TNo.	Min	Sec
91	91	91

·Operation (PLAY, SEARCH, etc.) in progress perfectly identical with that in the normal mode.

·Protection/Error upon occurrence
(a) Error number indicated

ERROR-xx

Select the display with the BAND key.

(b) Track number and absolute time indicated

TNo.	Min	Sec
10	40	05

7.3 BLOCK DIAGRAM

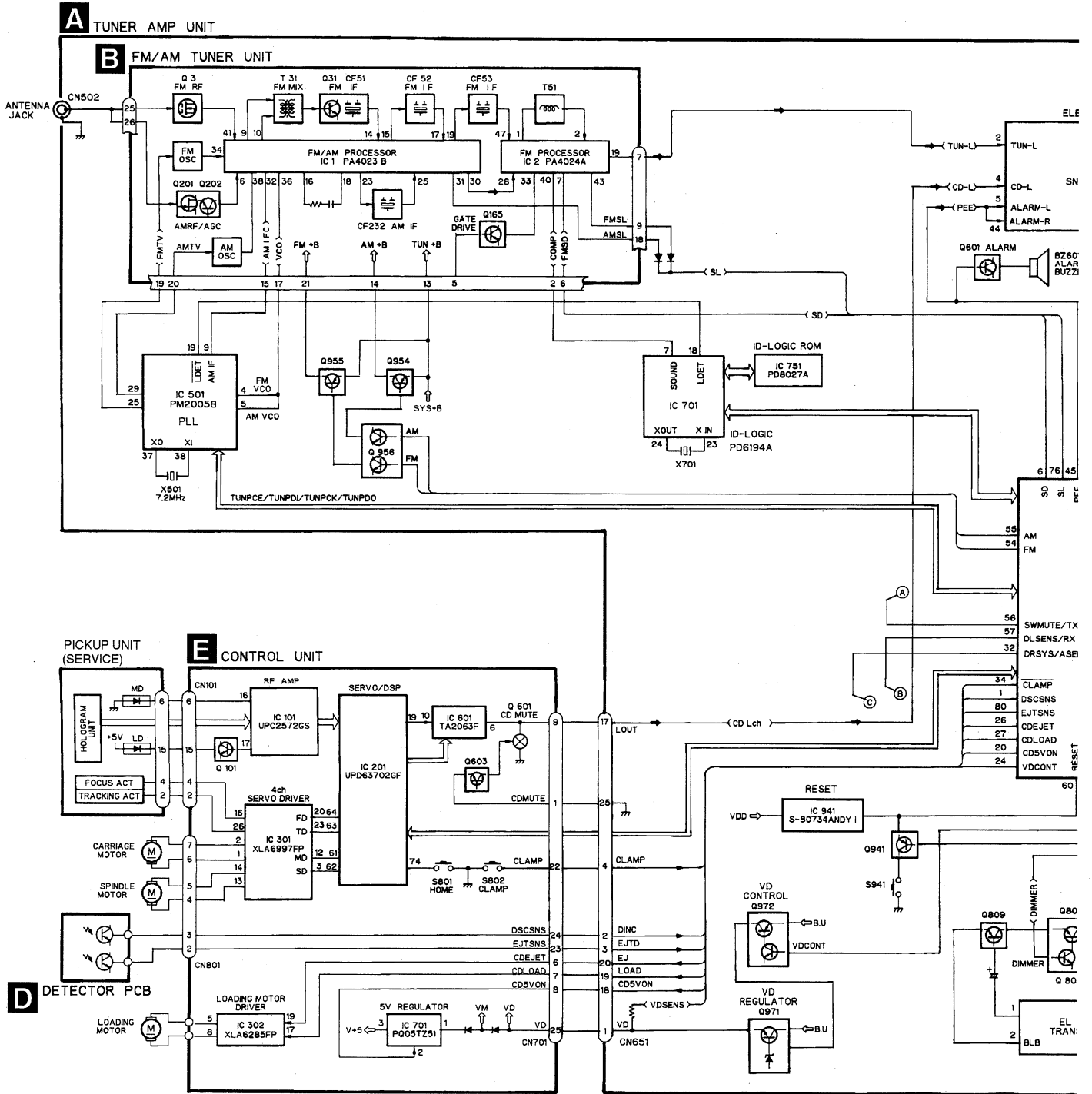

8. OPERATIONS AND SPECIFICATIONS

Connecting the Units

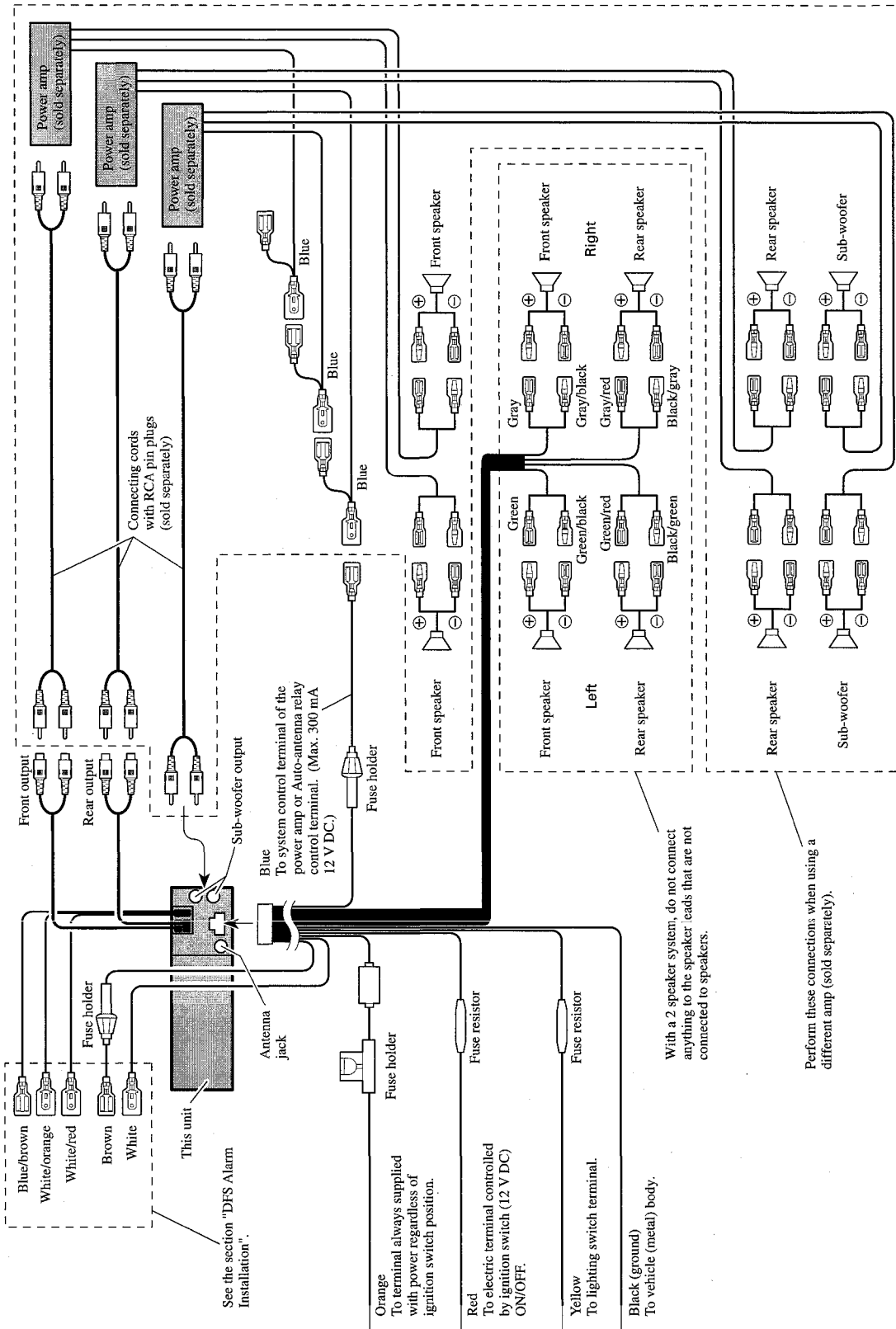

Fig. 30

CAUTION

- Because of the complexity of today's technically advanced vehicle wiring systems, we recommend that your DFS Alarm be installed **ONLY** by a professional Pioneer installer.
- Install the unit so that it can be quickly disconnected in case the engine doesn't start even if the unit operates correctly. (Refer "STARTER CUT-OFF", "Avoiding Trouble" section.)

Affix the included deterrent stickers to the inside of the front door windows.

Description

- White (DOOR SWITCH)** (Fig. 31 & 32)
This lead is used to trigger DFS Alarm when any door is opened and may be connected to either positive or negative (+/-) type door pin switches.
- Brown (ALARM OUTPUT)** (Fig. 33)
This lead is a selectable constant or pulsed positive (+) output capable of driving up to 2 relays (500 mA) max. Use this lead to trigger relays for siren, horn, honk or flashing lights.
- White/Red (ALARM SENSOR)** (Fig. 34)
This lead is a negative (-) input and is provided for hookup of negative triggering sensors such as shock, or glass sensors (sold separately).
- White/Orange (DOOR LOCK)** (Fig. 35)
This lead is used to disarm DFS Alarm from power door lock systems or alarm systems with remote unlock. This lead may be connected to door lock systems with either positive or negative (+/-) unlock triggers.
- Blue/Brown (STARTER CUT-OFF)** (Fig. 36)
This lead provides a positive (+) constant output when DFS Alarm is triggered and remains constant for 30 minutes or until DFS Alarm is disarmed. This output should be used with an optional relay to disable starter.

Door Switches

The DFS Alarm's door trigger input is designed to work with either positive or negative door pin switches. After hookup, simply set door system type from DFS Alarm Setting Menu.
Dome/night Delay-DFS Alarm will wait for last door to close and courtesy light to turn off before Exit Delay Timer Starts.

DOOR SWITCH (White)

- Grounding Type Switch:**
GM, Chrysler, Japanese, and most European vehicles

Note:

- Set DFS Alarm to recognize ground trigger from DFS Alarm Setting Menu. Set Door System to "DR-L:CLS".

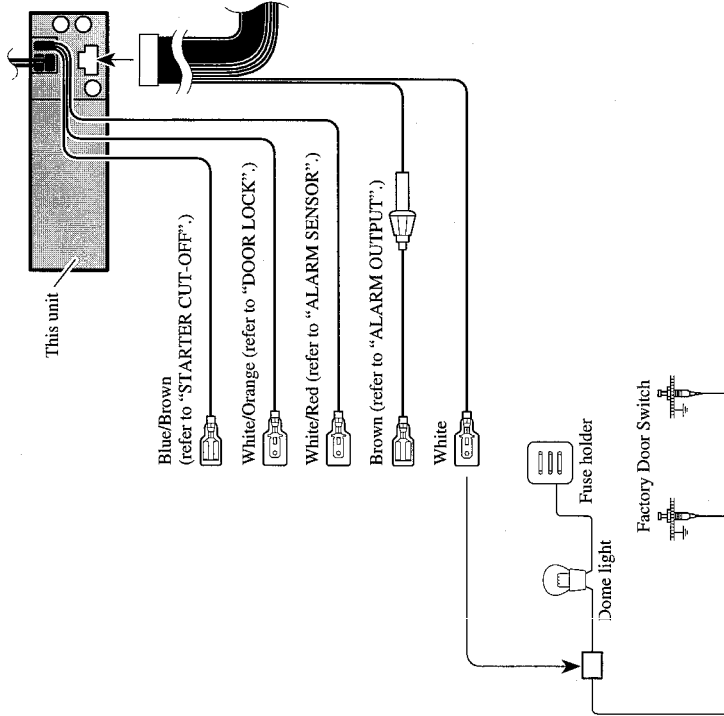

Fig. 31

DFS Alarm Installation

■ **Positive (Non-grounding) Type Switch:**

Ford, Jaguar, Mercedes

Note:

- Set DFS Alarm to recognize positive trigger from DFS Alarm Setting Menu. Set Door System to "DR-H:CLS".

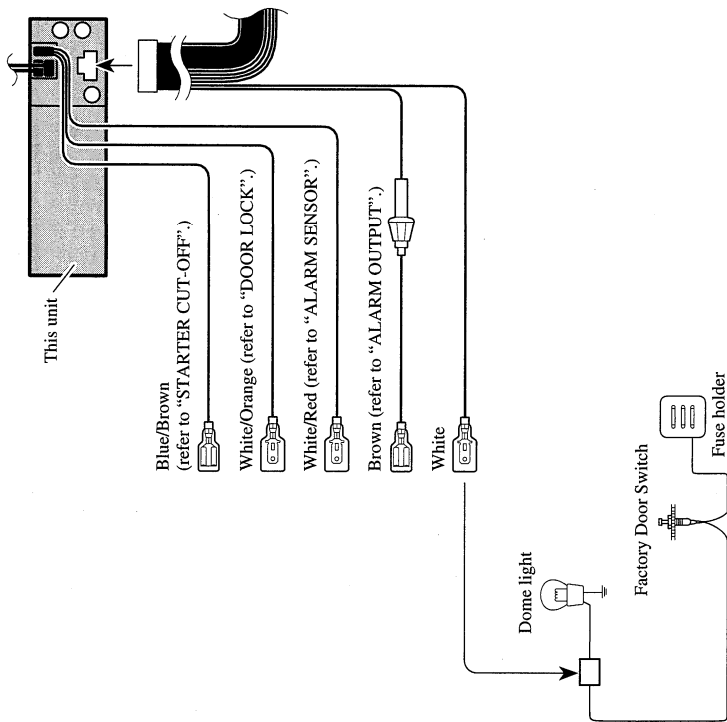

Fig. 32

■ **Installing New Pin Switches**

Separately sold pin switches are available that can be used to protect your vehicle's trunk, hood etc. When you purchase these, make sure that you first confirm that they can be used with your vehicle's door system type. Follow the makers instructions as to installation and wiring.

ALARM OUTPUT (Brown)

The brown lead provides a +12 V, constant or pulsed output while alarm is sounding. This lead has a maximum current capability of 500 mA and can be used to trigger a relay to sound a siren, horn or flash lights.

■ **Recommended Wiring:**

- 30 amp relay (sold separately) required to operate siren, horn or lights.
- Connect Brown wire to one side of relay coil.
- Connect ground to other side of coil.

For sirens, horns or lights requiring +12 V trigger

- Connect normally open to fused, constant +12 V source.

For horns or lights requiring ground trigger

- Connect normally open pin to ground.

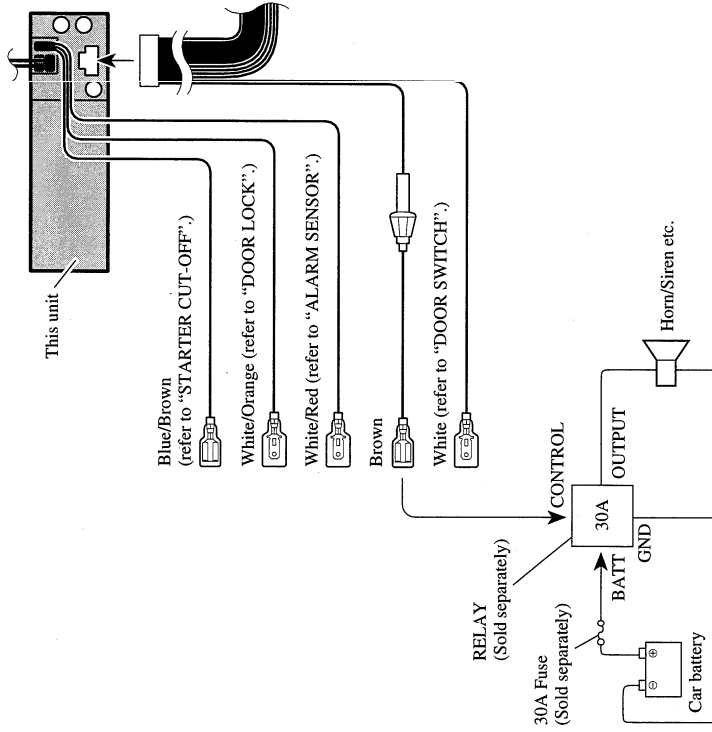

Fig. 33

DFS Alarm Installation

ALARM SENSOR (White/Red)

The white/red lead is a negative triggered (Grounding) input that can be connected to various separately sold shock or glass sensors. There is no limit as to how many sensors are connected, so you can ensure total protection of your vehicle. Follow the makers instructions as to installation and wiring.

Note:

- If the shock sensor detects vehicle vibrations, use the negative (-) output type. If you use the positive (+) output type, the alarm will sound continually, and the shock sensor will not operate correctly.

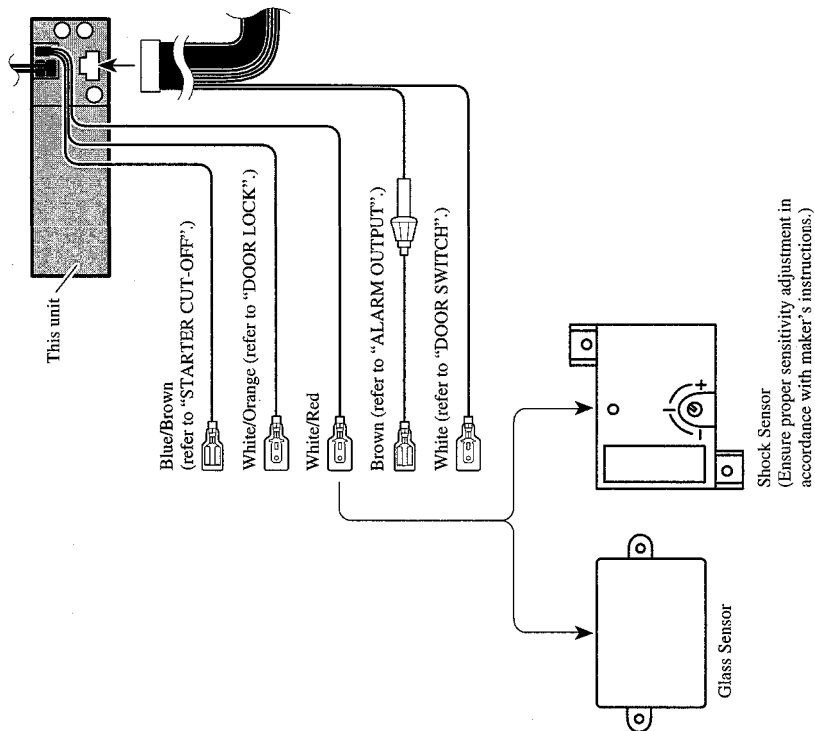

Fig. 34

DOOR LOCK (White/Orange)

The white/orange lead should be connected to the "unlock" lead for your vehicles door locking system, so that when you open the driver's door by your vehicle's remote control, your Pioneer DFS Alarm is deactivated.

First, locate the two wires from the lock/unlock switch that operate the factory door lock solenoids for the driver's side. Using a meter, determine which lead is used to unlock the door, connect this to the white/orange lead of your Pioneer Car Stereo. In the DFS Alarm Setting Menu, select the door-lock system type according to your vehicle (grounding or non-grounding).

If you have difficulty wiring this connection, please consult your nearest Installation specialist.

Note:

- If your vehicle is equipped with a central door lock but the glass or shock sensor is not connected, if the window is broken and the central door lock is released, this unit's DFS Alarm will not operate.
- Pioneer recommends that both a shock sensor and glass sensor be installed when you are using the "Remote Disarming" feature.

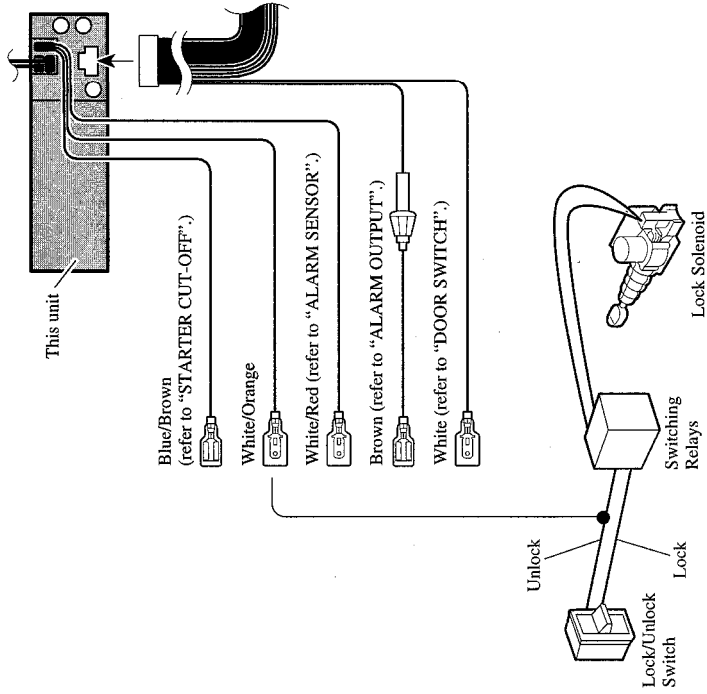

Fig. 35

DFS Alarm Installation

STARTER CUT-OFF (Blue/Brown)

The blue/brown lead will provide a continuous +12 V output while alarm is sounding and for 30 minutes after initial trigger, up to 5 consecutive triggers. This lead has a maximum current capability of 500 mA and can be used to trigger a relay to disable the starter.

Note:

- In order for the "DFS Alarm" to operate when a window is broken, connect this unit's White/Red (ALARM SENSOR) lead to glass sensor securely.
- In order for the "DFS Alarm" to operate when a door is forced open, connect this unit's White (DOOR SWITCH) lead securely.

■ **Recommended Wiring:**

- 30 amp relay (sold separately) required to disable starter.
- Connect blue/brown lead to one side of relay coil.
- Connect other side of coil to ground.
- Locate starter wire under dash, near steering column.
- Cut starter wire and try to start vehicle to verify wire is correct.
- Connect key side of cut wire to normally closed pin.
- Connect starter side of cut wire to common pin.

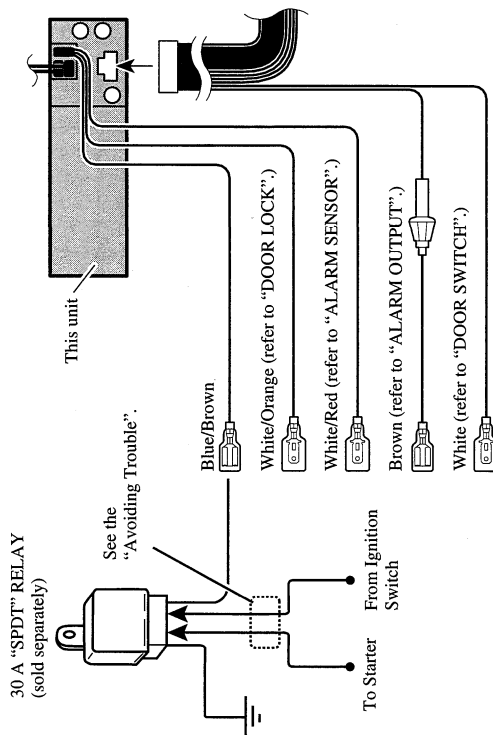

Fig. 36

Avoiding Trouble

You may not be able to start the engine even if you operate the unit correctly. Take the following measures to deal with this problem. When installing a switch to deal with such a problem, install it where it is least conspicuous.

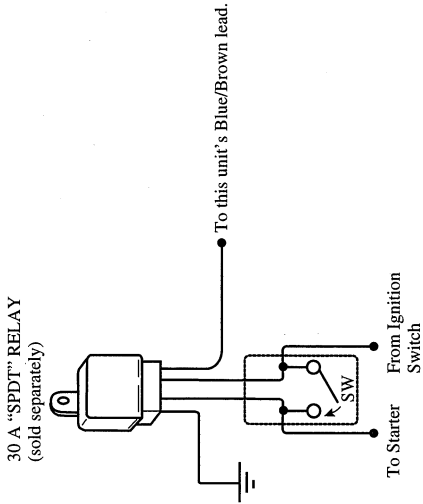

Fig. 37

Note:

- Use cords and switches having current handling (amperage) capacity greater than that of the relay to be attached.

Key Finder

■ Head Unit

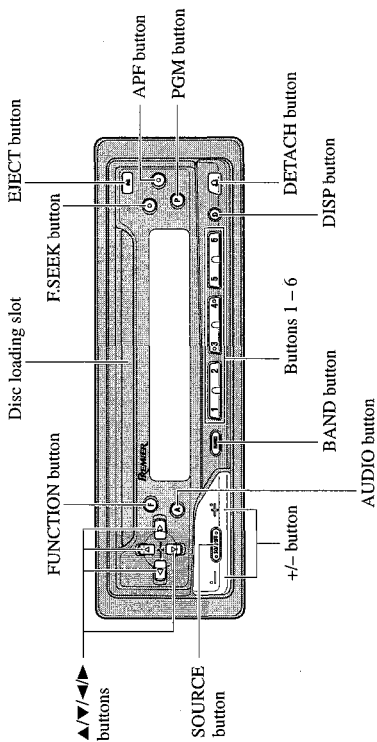

■ Remote Controller

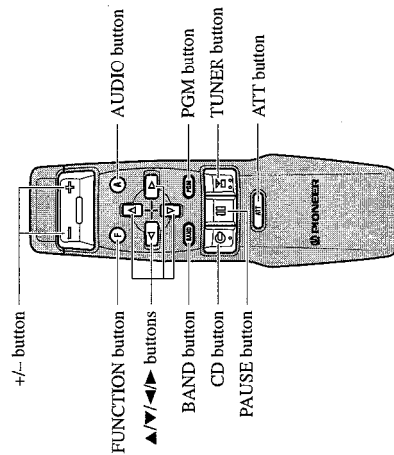

Remote Controller and Care

Using the Remote Controller

This product is equipped with a remote controller for convenient operation.

- Point the controller in the direction of the front panel to operate.
- When the controller is not in use, attach it firmly to the provided mounting base.

Precaution:

- Do not store the remote controller in high temperatures or direct sunlight.
- The controller may not function properly in direct sunlight.
- Do not let the remote controller fall onto the floor, where it may become jammed under the brake or accelerator pedal.
- Open the cover on the rear of the remote control, and you'll find a switch. Do not change this switch's position from the MAIN UNIT position. (Initially, the switch is set to the MAIN UNIT position.) If you change the switch setting, correct operation of this unit will not be possible.

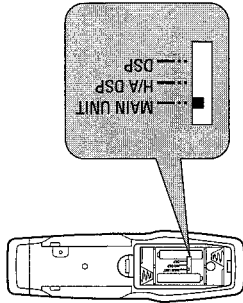

Batteries

- Remove the cover on the back of the remote controller and insert the batteries with the (+) and (-) poles pointing in the proper direction.

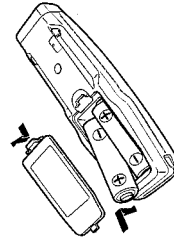

Precaution:

- Use only AAA or IEC R03 1.5 V batteries.
- Remove the batteries if the remote controller is not used for a month or longer.
- Do not attempt to recharge the supplied batteries.
- Do not mix new and used batteries.
- If the event of battery leakage, wipe the remote controller completely clean and install new batteries.

Tuner Operation

Basic Operation of Tuner

1. Select Tuner.

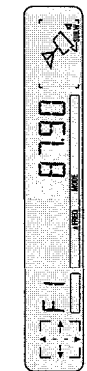
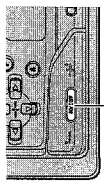

Each press changes the source ...

2. Select the desired band.

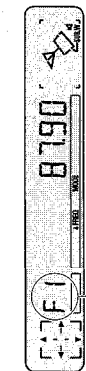
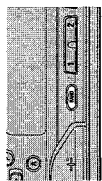

F1 → F2 → F3 → AM

3. Tune the receiver to a higher or lower frequency.

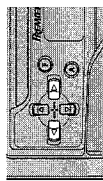

"stereo"

This product's tuner lets you select the tuning by changing the length of the time you press the button.

Manual Tuning (step by step)	0.3 seconds or less
Seek Tuning (automatically)	0.3 – 2 seconds
Manual Tuning (continuously)	2 seconds or more

Note:

- "stereo" indicator lights when a stereo station is selected.

Basic Operation

Switching Power ON/OFF

- Select the desired source (such as the tuner).

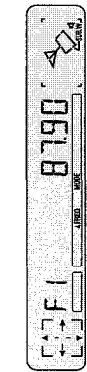
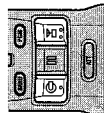
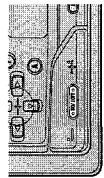

■ **Head Unit**

Each press of the SOURCE button selects the desired source in the following order:

Built-in CD player → Tuner

To switch the sources OFF, hold down the SOURCE button for 1 second or more.

■ **Remote Controller**

Each press of the CD button selects the desired source in the following order:

Built-in CD player → Sources OFF

Each press of the TUNER button selects the desired source in the following order:

Tuner → Sources OFF

Note:

- The sound source will not change if no disc is set in this unit.

Tuner Operation

Local Seek Tuning

This mode selects only stations with especially strong signals.

1. Select the Local mode (LOC) in the Function Menu.
2. Switch the Local mode ON or OFF.

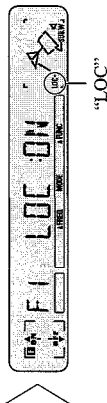
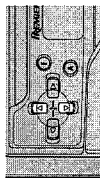

To cancel the Function Menu, press the BAND button.

Preset Tuning

Up to 18 FM stations (6 in F1 (FM1), F2 (FM2) and F3 (FM3)) and 6 AM stations can be stored in memory. Store the stations in memory under buttons 1 – 6 beforehand with the Preset Memory function.

Preset Memory

1. Select the station whose frequency you want to store in memory.
2. Press one of buttons 1 – 6 for 2 seconds or longer to store the desired stations. (eg. Press button 4.)



Hold for 2 seconds

The station is stored in memory under the selected button.

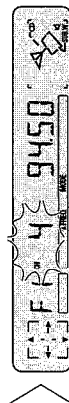

4. Raise or lower the volume.

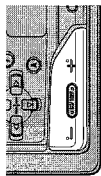

5. Turn the source OFF.

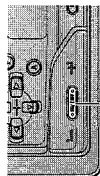

Hold for 1 second

Entering the Function Menu

In this menu you can select tuner functions.

- Select the desired mode in Function Menu.

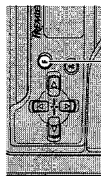

Each press changes the mode ...

Each press changes the mode ...

Each press of the FUNCTION button selects the mode in the following order:

FSCAN → FBSM → APF → MULTI-ST → LOC → SEEK SEL

To cancel the Function Menu, press the BAND button.

Note:

- In modes other than LOC, you can use ID LOGIC functions. Refer to "Using ID LOGIC" for details and instructions on how to use these functions.
- After entering the Function Menu, if you do not perform an operation within about 30 seconds, the Function Menu is automatically canceled.

Using ID LOGIC

Recalling Preset Stations

There are two ways to recall preset stations.

- **Direct Recall**
 - Press one of buttons 1 - 6 to recall a station preset under that button. (eg. Press button 4.)



- **Sequential Recall**

- Recall a station preset under button 1 - 6.

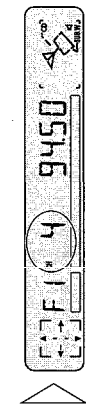
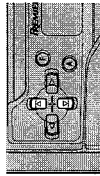

This unit features a tuner with ID LOGIC functions. ID LOGIC is a database of information about AM and FM stations throughout the United States and in some parts of Canada and Mexico. To enable you to take advantage of this information, this unit features a wide range of functions. You get display of Broadcast Station Call Sign and Format (Program type), tuning to stations broadcasting a desired format.

Note:

- Sections 1 and 2 provide explanations concerning menus for ID LOGIC operations. Sections 3 to 7 explain basic operations, and Sections 8 to 11 deal with special functions.
- Before using ID LOGIC functions, you must first perform Location Set-up. (Refer to Section 3.)

1. Entering the Function Menu

In this menu you can select ID LOGIC functions.

- **Select the desired mode in Function Menu.**

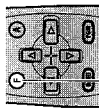
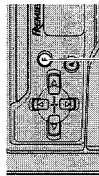

Each press changes the mode...

Each press changes the mode...

Each press of the FUNCTION button selects the mode in the following order:

FSCAN → FB5M → APF → MULTI-ST → LOC → SEEK SEL
To cancel the Function Menu, press the BAND button.

Note:

- LOC is a normal tuner function. For an explanation on this function and how to use it, refer to "Local Seek Tuning" on page 11.
- After entering the Function Menu, if you do not perform an operation within about 30 seconds, the Function Menu is automatically canceled.

2. Entering the Detailed Setting Menu

In this menu you can perform Location Set-Up, Update and Programmable button settings.

1. Enter the Detailed Setting Menu.

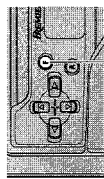

Hold for 2 seconds

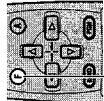

Hold for 2 seconds

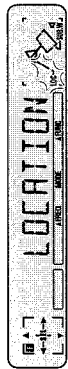

2. Select the desired mode.

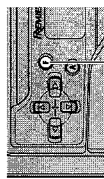

Each press changes the mode ...

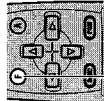

Each press changes the mode ...

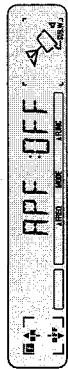

Each press of the FUNCTION button selects the mode in the following order:

LOCATION → APF → UPDATE → PGM-FUNC

To cancel the Detailed Setting Menu, press the BAND button.

Note:

- You can cancel the Detailed Setting Menu by pressing the FUNCTION button again for 2 seconds or more.

3. Location Set-Up

Set the name of the country, state and city (nearest city to the vehicle position) that the vehicle is positioned in.

1. During FM reception, select the Location Set-Up mode (LOCATION) from the Detailed Setting Menu.

2. Select the country.

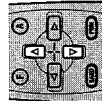
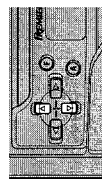

Continued overleaf.

3. Advance to next selection.

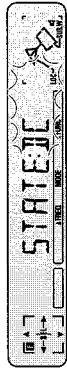
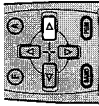
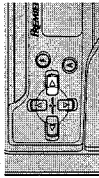

4. Select the state.

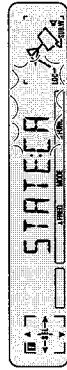
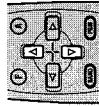
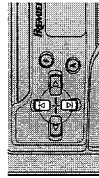

States are stored alphabetically.

5. Advance to next selection.

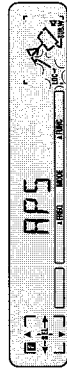
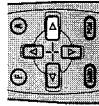
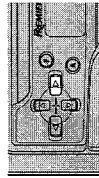

6. Using the APS (Auto Position Setting) function, automatically set the city the vehicle is located in.

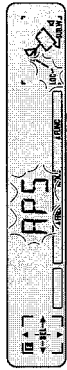
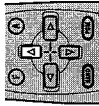
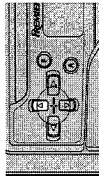

When you have completed APS, the city name flashes in the display.

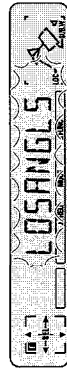

When you have correctly set the city name, perform procedure 10 to cancel the Location Set-Up mode.
If you have not correctly set the city name, perform procedure 7 to set the name manually.

7. Manually set the city.

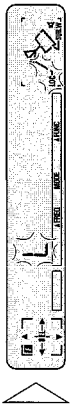
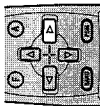
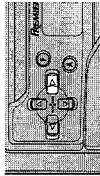

The initial letters of city names are displayed for city name selection.

8. Select the initial of the city name.

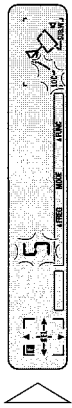
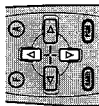
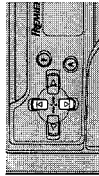

9. Fix your choice of the initial.

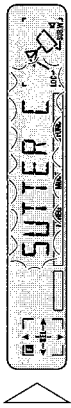
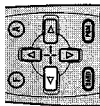
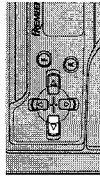

One city having your selected initial letter will be displayed.

10. Select the city.

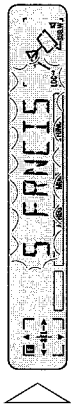
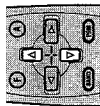
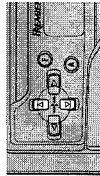

Cities are stored alphabetically.

11. When the correct city has been selected, cancel the Location Set-Up mode.

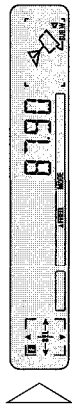
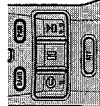
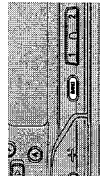

4. Format Tuning

This product allows you to look for a station by format (program type). Formats are divided into 8 types, such as ROCK, COUNTRY, NEWS and TALK.

Group Formats	Corresponding Formats
ROCK	TOP 40 CLS ROCK ROCK
RASY LIS	SOFT ADLT HIT OLDIES
CLS/JAZZ	CLASSICL JAZZ
COUNTRY	NOSTL GIA PUBLIC COUNTRY
R AND B	R AND B SOFT R/B
INFO	NEWS
RELIGION	REL MUSC REL TALK
MISC	LANGUAGE MISC

1. Select Format Seek mode.

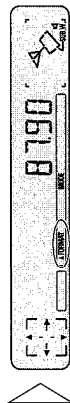
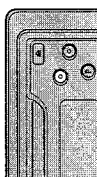

"FORMAT"

To cancel Format Seek mode, repeat the preceding operation.

2. Select a group format.

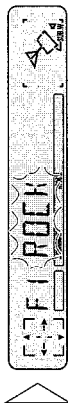
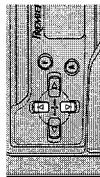

A station broadcasting a program with a different group format from the format of the currently received broadcast station is selected.

Press the ▲ button to select stations with the next group format, and the ▼ button to select stations with the preceding group format.

3. Select a station.

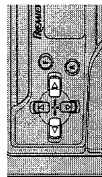

A station broadcasting a program with the same group format as the currently received broadcast station is selected.

Press the ► button to select a station with a higher frequency and the ◀ button to select a station with a lower frequency.

Note:

- If you perform operation 3 during reception of a broadcast station with no format data, "NO FRMT" is displayed. The tuner then returns to the prior frequency.
- "NO STATN" is displayed if no station with the selected group format can be received.
- The tuner then returns to the prior frequency.
- "NO DATA" will be displayed if there is no station data for the specified group format stored in the ID LOGIC database.
- If the set vehicle location is different from the current location, the selected group format and the format of the program may differ.
- If "MS" is displayed, refer to the "8. Multi-Station" section.
- You can also select and cancel the Format Seek mode when in the Function Menu SEEK SEL mode.

5. F.BSM (Format Best Stations Memory)

This function automatically places receivable stations into presets 1 - 6, in order from strongest to weakest, for a selected group format.

Firstly, choose your desired group format as described in "4. Format Tuning".

1. Select the F.BSM mode (FBSM) in the Function Menu.

2. Start F.BSM.

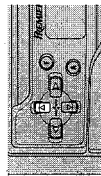

To cancel FBSM midway, press the ▼ button.

When FBSM is completed, "FBSM" in the display stops flashing.

3. Select a preset station by pressing a button 1 - 6. (eg. Press button 4.)

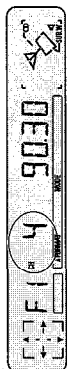
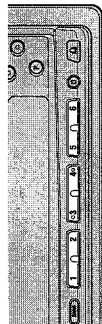

Note:

- In areas where there are not 6 or more stations covered by format tuning, the previously stored contents may be retained.
- If "MS" is displayed, refer to the "8. Multi-Station" section.

6. F.SCAN (Format Scan)

This function allows you to scan receivable stations with the same format type as that of the present station that you are listening to.

1. Select the F.SCAN mode (FSCAN) in the Function Menu.

2. Start F.SCAN.

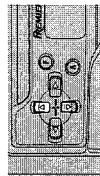

Stations with the same format are tuned one after another at 8 second intervals.

Using ID LOGIC

3. Cancel the scan function and enable you to remain tuned to the present station.

If the Function Menu has been canceled automatically, select the F.SCAN mode in the Function Menu again.

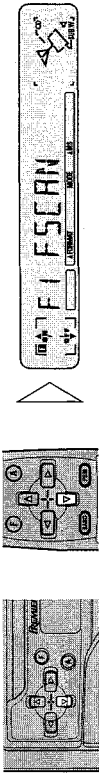

To cancel the Function Menu, press the BAND button.

Note:

- If "MS" is displayed, refer to the "8. Multi-Station" section.

7. Display Modes

This function can be used to scroll through the various display modes for Band/Frequency, Call Sign/Frequency and Call Sign/Format.

- By pressing DISP button it is possible to scroll through the various displays.

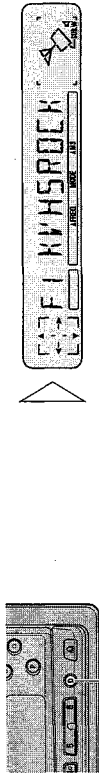

Each press changes the display ...

Note:

- You cannot switch to these displays if Call Sign and Format data for the station you are receiving are not stored in the tuner.
- If the set vehicle position is different from the current location, a different Format and Call Sign from those of the tuned-in station may be displayed.
- The program of some stations may differ from that indicated by their Format.

8. Multi-Station

When "MS" is displayed, this indicates there are a number of stations having the same broadcasting frequency stored in the ID Logic database.

For example, if you have performed Format Tuning; you may be listening to a station with a different format type than which you chose.

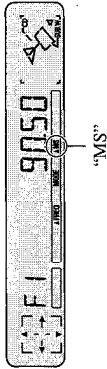

- Display Call Sign and Format indications, and confirm that Call Sign and Format agree with those of the program being broadcast.

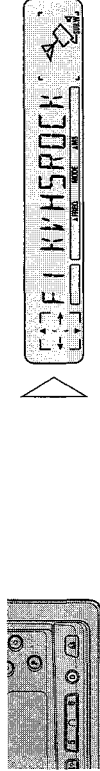

Note:

- If the format of the program differs from the format you want to listen to, perform Format Tuning, F.BSM or F.SCAN again.
- If the Call Sign and Format do not agree with those of the program, display indications change.

Changing Multi-Station Call Sign and Format

1. Select the Multi-Station mode (MULTI-ST) in the Function Menu.

2. Select Call Sign and Format.

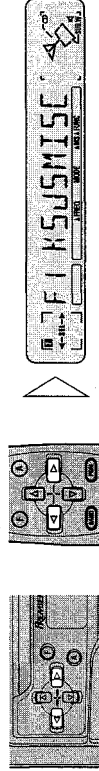

Pressing the button switches the Call Sign and Format of the station broadcasting on the frequency currently being received. Select the appropriate Call Sign and Format for the broadcast.

To cancel the Function Menu, press the BAND button.

Using ID LOGIC

10. Update

This function is provided for amendment, deletion and addition of data (call sign and format) relating to stations registered in the ID Logic database.

- **Note:** Updated data is not cleared even if you disconnect the vehicle's battery or if you press the RESET button. Clear updated data in the CLEAR mode. (Refer to page 94).

■ **Amending and deleting data**

If the call sign or format for a station changes, then the data registered in the ID Logic database should be changed.

Also if a station has closed down, you should delete that data from the database.

Database amendments and deletions can be performed for a total of 161 stations.

1. **Set the frequency to that of the station, whose data you want to amend or delete.**
2. **To amend or delete data for a station that cannot be received from the vehicles present location, refer to "3. Location Set-Up" to manually set the vehicles position to a city, where that station can be received.**
3. **When "MS" is lit, coordinate the broadcast content and the display.**
(Refer to "8. Multi-Station" section.)
4. **Select the Update mode (UPDATE) in the Detailed Setting Menu.**

9. APF (Auto Position Follow)

■ **When the source is the tuner**

When you drive away from the city vicinity to which the vehicles location has been set to, the quality of the received station broadcast will deteriorate. Before searching for a new station, you must first update your vehicle's position.

- **Start APF.**

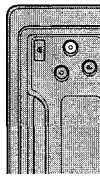

Note:

- You can also start APF in the Function Menu.

■ **When the source is the built-in CD player**

Your vehicle's position can be automatically updated at regular intervals when listening to the built-in CD player; if APF has been turned on.

1. **Select the APF ON/OFF mode (APF :OFF) in the Detailed Setting Menu.**
2. **Switch APF ON or OFF.**

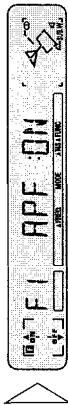
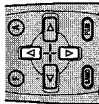
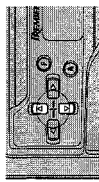

To cancel the Detailed Setting Menu, press the BAND button.

Using ID LOGIC

5. Select the EDIT mode.

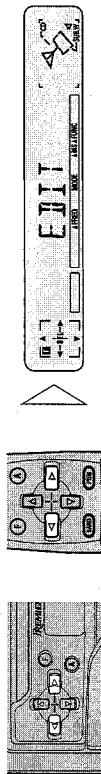

Mode switches between EDIT/ADD/CLEAR each time you press the button.

6. Enter EDIT mode.

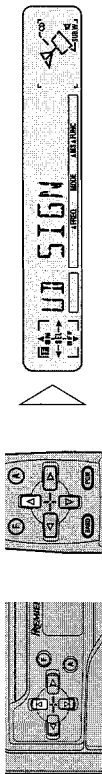

The Call Sign is displayed.

Note:

- If you try to make data amendments or deletions for more than 161 stations, "EDT FULL" will be displayed.

7. Select the character to be amended.

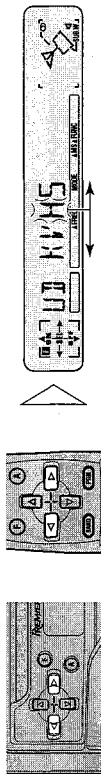

8. Select a different character.

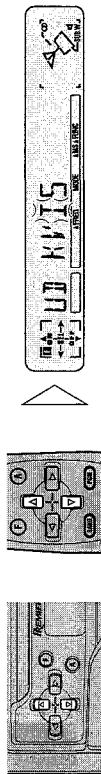

Note:

- To delete data, use a blank for all four characters.

9. If you press the ► button when the last of the four call sign characters is flashing, the format type is displayed.

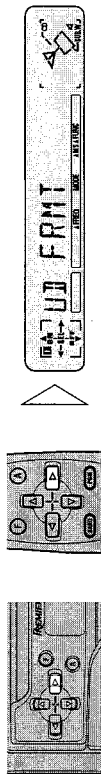

Continued overleaf.

10. Select format type.

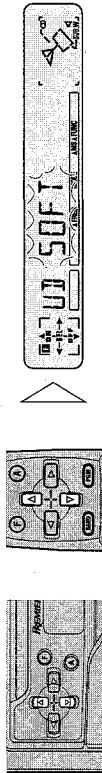

Each time you press the button, the format type changes as follows:
TOP 40/CLS ROCK/ROCK/SOFT/ADLT HIT/OLDIES/CLASSICL/
JAZZ/NOSTALGIA/PUBLIC/COUNTRY/R AND B/SOFT R/B/
NEWS/REL MUSC/REL TALK/LANGUAGE/MISC

11. Press the ► button after completing format type selection.

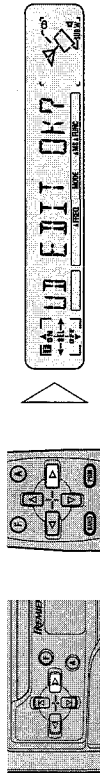

A registration confirmation message is displayed.

12. Registering amended/deleted data in the ID Logic database.

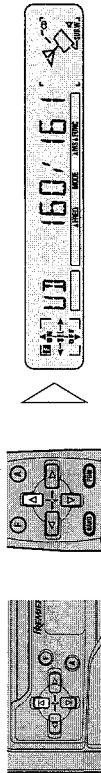

The remaining space for amendments/deletions is displayed for a short while.

Note:

- To cancel the EDIT mode without registering amended/deleted data, press the ▼ button.

13. Cancel the update mode.

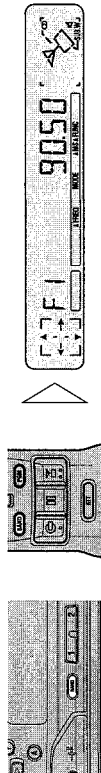

Using ID LOGIC

■ Registering New Data

A newly opened station, or a station whose data is not registered in the ID Logic database, may be manually registered. New data registration can be performed up to 63 times.

1. Follow steps 1 – 4 of “Amending and deleting data”.

2. Select the ADD mode.

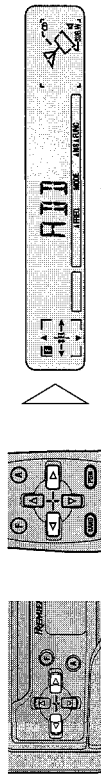

Mode switches between EDIT/ADD/CLEAR each time you press the button.

3. Enter ADD mode.

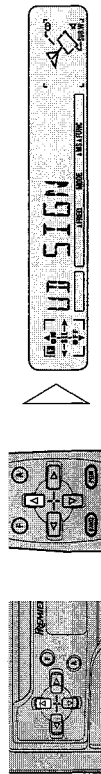

Call sign “AAAA” is displayed.

Note:
• If you try to add data for more than 63 stations “ADD FULL” will be displayed.

4. Follow steps 7 – 10 of “Amending and deleting data”, to enter your desired data.

5. Press the ► button after completing format type selection.

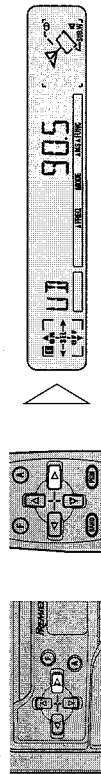

The frequency is displayed.

Continued overleaf.

6. Select frequency.

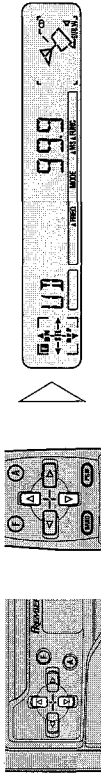

7. Press the ► button after completing frequency selection.

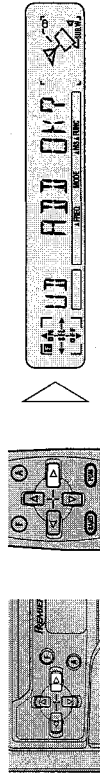

A registration confirmation message is displayed.

8. Register additional new data in the ID Logic database.

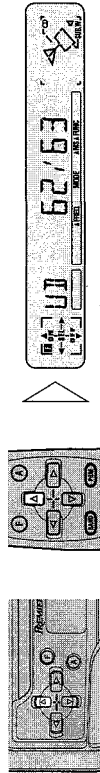

The remaining space for additions is displayed for a short while.

Note:

- To cancel the ADD mode without registering additional data, press the ▼ button.

9. Cancel the Update mode.

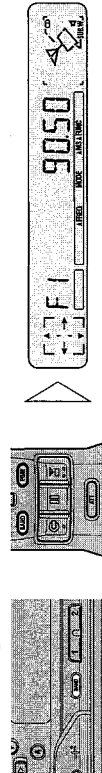

Note:

- Data items registered in the ADD mode can be amended/deleted individually. (Refer to “Amending and deleting data”.)

■ **Clearing amended, deleted, and additional data**

You can clear amended, deleted and additional data from the ID Logic database.

1. Select the Update mode (UPDATE) in the Detailed Setting Menu.

2. Select the CLEAR mode.

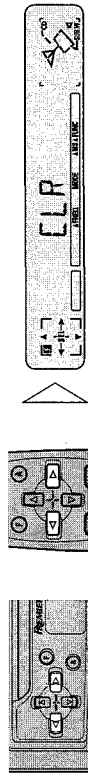

Mode switches between EDIT/ADD/CLEAR each time you press the button.

3. Enter CLEAR mode.

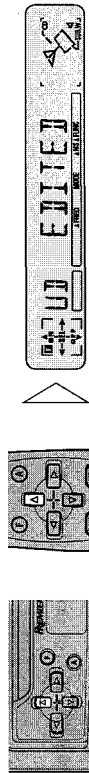

4. Select the data you want to clear.

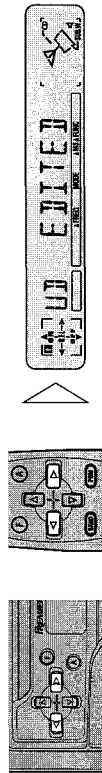

Display switches between EDITED/ADED/ALL each time you press the button.

To clear amended/deleted data, select "EDITED". To clear additional data, select "ADED". To clear both amended/deleted and additional data, select "ALL".

(In this example, "EDITED" is selected.)

Continued overleaf.

5. Press the ▲ button.

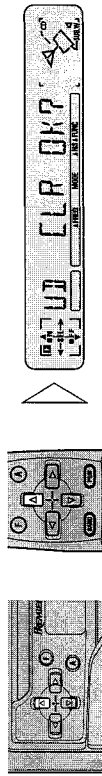

A clear confirmation is displayed.

6. Clear data.

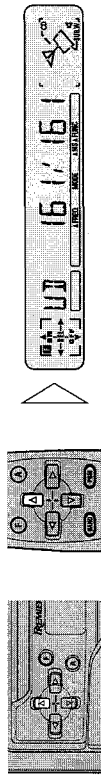

The remaining space for amendments/deletions (or additions) is displayed for a short while.

Note:

- Press the ▼ button to cancel the CLEAR mode without clearing data.

7. Cancel the update mode.

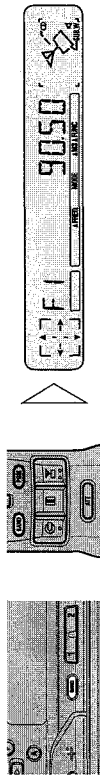

Using the Built-in CD Player

Basic Operation of Built-in CD Player

The built-in CD player plays one standard 12 cm or 8 cm (single) CD at a time. Do not use an adapter when playing 8 cm CD.

1. Insert the disc with the recorded (iridescent) surface down.

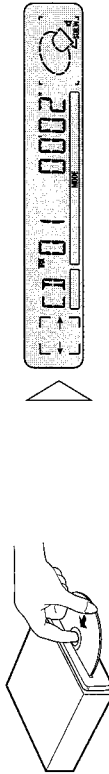

2. Select the desired track (and phrase).

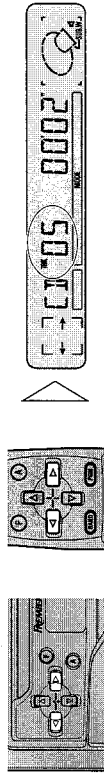

This product's built-in CD player lets you select the Track Search function or Fast-forward/Reverse function by changing the length of the time you press the button.

Track Search	0.5 seconds or less
Fast-forward/Reverse	Continue pressing

3. Raise or lower the volume.

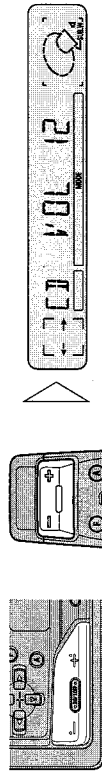

11. Using the PGM (Programmable) Button

You can memorize Function Menu FBSM (FBSM), FSCAN (FSCAN), and Multi-Station (M-ST) functions in the Programmable button. Initially, the FBSM function is memorized in the Programmable button.

- **Setting the Programmable Button**

1. Select the Programmable button setting mode (PGM-FUNC) in the Detailed Setting Menu.

2. Select the function you want to memorize in the Programmable button.

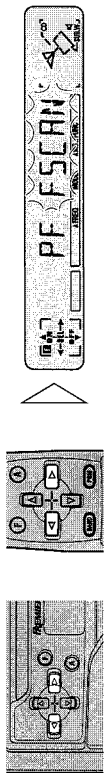

3. Memorize the function in the Programmable button.

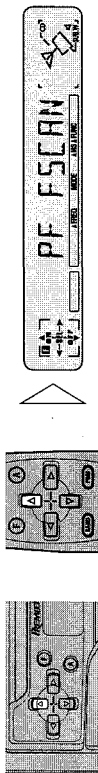

To cancel the Detailed Setting Menu, press the BAND button.

- **Using the Programmable Button**

The Programmable button operates in a different way depending on the function programmed (memorized).

- **Use the programmable button.**

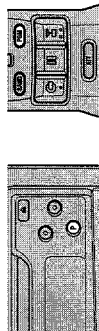

Function	Press	Hold for 2 seconds
FBSM	OFF	ON
FSCAN	ON/OFF	
M-ST	Select	

Using the Built-in CD Player

4. Remove the disc.

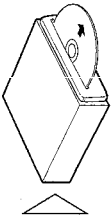
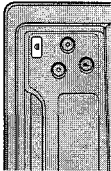

Note:

- The CD function can be turned ON/OFF with the disc remaining in this product. (See page 84.)
- Discs left partially inserted after ejection may incur damage or fall out.
- If a disc cannot be inserted fully or playback fails, make sure the recorded side is down, push the EJECT button and check the disc for damage before reinserting it.
- If a CD is inserted with the recorded side up, it will be ejected automatically after a few moments.
- If the built-in CD player cannot operate properly, an error message (such as "ERROR-14") appears on the display. Refer to "Built-in CD Player Troubleshooting" on page 98.

Pause

- Stop playback temporarily or restarts the system.

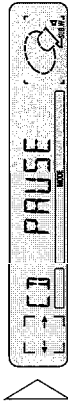
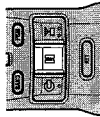

Note:

- You can also switch the Pause function ON/OFF in the Function Menu.

Entering the Function Menu

In this menu you can select built-in CD player functions.

- Select the desired mode in Function Menu.

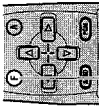
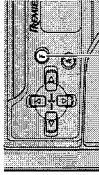

Each press changes the mode ...

Each press changes the mode ...

Each press of the FUNCTION button selects the mode in the following order:

RPT → RDM → SCAN → PAUSE

To cancel the Function Menu, press the BAND button.

Note:

- After entering the Function Menu, if you do not perform an operation within about 30 seconds, the Function Menu is automatically canceled.

Repeat Play

Repeat Play plays the same track repeatedly.

1. Select the Repeat mode (RPT) in the Function Menu.
2. Switch the Repeat Play ON or OFF.

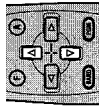
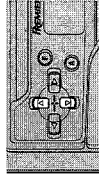

To cancel the Function Menu, press the BAND button.

Note:

- If you perform Track Search or Fast-forward/Reverse, Repeat Play is automatically canceled.

Using the Built-in CD Player

Random Play

Random Play plays the tracks on a CD in random order for variety.

1. Select the **Random mode (RDM)** in the **Function Menu**.
2. Switch the **Random Play ON or OFF**.

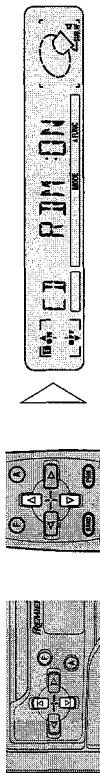

To cancel the Function Menu, press the **BAND** button.

Note:

- Since playback is random, the same track may be repeated consecutively.

Scan Play

Scan Play plays the first 10 seconds or so of each track on a CD in succession.

1. Select the **Scan mode (SCAN)** in the **Function Menu**.
2. Switch the **Scan Play ON**.

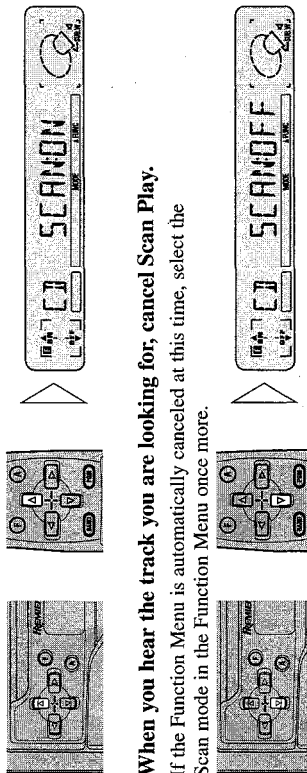

3. When you hear the track you are looking for, cancel **Scan Play**.

If the Function Menu is automatically canceled at this time, select the Scan mode in the Function Menu once more.

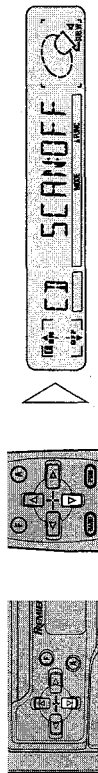

Playback of the current track continues.

To cancel the Function Menu, press the **BAND** button.

Note:

- Scan Play is canceled automatically after all the tracks on a disc have been scanned.

Using the PGM (Programmable) Button

In the Function Menu, you can memorize the **Pause (PAUSE)**, **Repeat (RPT)**, and **Random (RDM)** functions in the **Programmable button**. Initially, **PAUSE** is memorized in the **Programmable button**.

■ **Setting the Programmable Button**

1. Select the **Programmable button setting mode (PGM-FUNC)**.

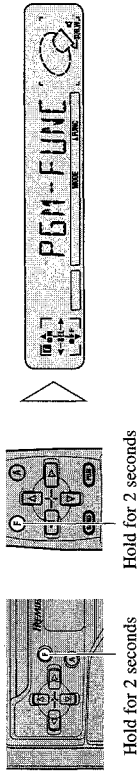

Hold for 2 seconds

Hold for 2 seconds

2. Select the **function you want to memorize in the Programmable button**.

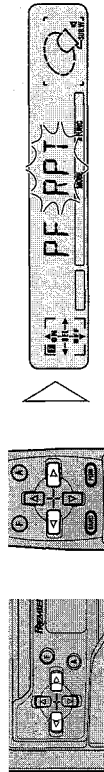

3. Memorize the **function in the Programmable button**.

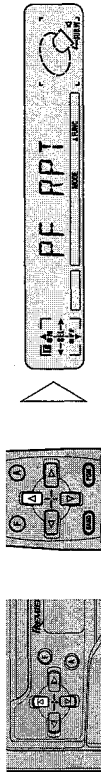

To cancel the Programmable button setting mode, press the **BAND** button.

Built-in CD Player Troubleshooting

■ **Using the Programmable Button**

The Programmable button operates in a different way depending on the function programmed (memorized).

- Use the **Programmable button**.

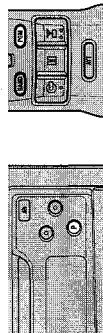

Function	Press	Hold for 2 seconds
PAUSE	ON/OFF	_____
RPT	ON/OFF	_____
RDM	ON/OFF	_____

Error Message

When problems occur with CD playback, an error message appears on the display. Refer to the table below to identify the problem, then take the suggested corrective action. If the error persists, contact your dealer or your nearest PIONEER Service Center.

Message	Possible cause	Recommended action
ERROR- 11, 12, 17, 30	Dirty disc.	Clean the disc.
ERROR- 11, 12, 17, 30	Scratched disc.	Replace the disc.
ERROR- 14	Unrecorded CD.	Check the disc.
ERROR- 10, 11, 12, 14, 17, 30, A0	Electrical or mechanical problem.	Turn the ignition ON and OFF, or switch to a different source, then back to the CD player.
HEAT	CD player overheating.	Discontinue play until the machine temperature drops.

Balance Adjustment

This function allows you to select a Fader/Balance setting that provides ideal listening conditions in all occupied seats.

1. **Select the Fader/Balance mode (FAD) in the Audio Menu.**
2. **Shift the balance progressively to the front or rear speakers.**
3. **Shift the balance to the left or right speaker, respectively.**

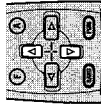
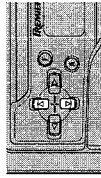
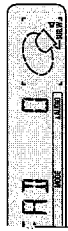

order:

"FAD F15" – "FAD R15" is displayed as it moves from front to rear.

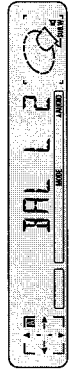
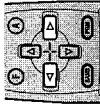
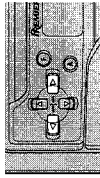

"BAL L 9" – "BAL R 9" is displayed as it moves from left to right.

To cancel the Audio Menu, press the BAND button.

Note:

- "FAD 0" is the proper setting when 2 speakers are in use.

Bass/Treble Adjustment

This product is equipped with two tone adjustment modes, the Bass (BAS) and Treble (TRE) modes.

1. **Select Bass mode (BAS) or Treble mode (TRE) in the Audio Menu.**
2. **Increase or decrease the intensity of the Bass or Treble, whichever is selected.**
3. **Repeat steps 1 – 2 above for the other Bass or Treble adjustment.**

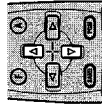
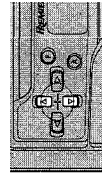

The display shows "+6" – "-6".

To cancel the Audio Menu, press the BAND button.

Audio Adjustment

Loudness Adjustment

The Loudness function compensates for deficiencies in the low and high sound ranges at low volume.

1. Select the Loudness mode (LOUD) in the Audio Menu.
2. Switch the Loudness function ON or OFF.

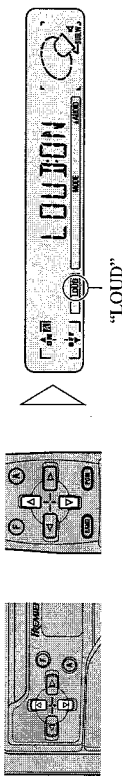

To cancel the Audio Menu, press the BAND button.

Sub-woofer Output

This product is equipped with a Sub-woofer output which can be switched ON or OFF. Initially, Sub-woofer output is ON.

1. Select the Sub-woofer ON/OFF mode (SUB.W) in the Audio Menu.
2. Switch the Sub-woofer output ON or OFF.

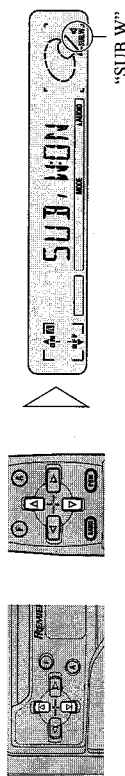

To cancel the Audio Menu, press the BAND button.

Note:

- Select the OFF setting when you do not want the Sub-woofer to operate.

Sub-woofer Setting Adjustment

When the Sub-woofer output is ON, you can adjust the cut-off frequency and the output level of Sub-woofer.

1. Select the Sub-woofer setting mode (80HZ 0) in the Audio Menu.

2. Select the frequency to 50 Hz, 80 Hz or 125 Hz.

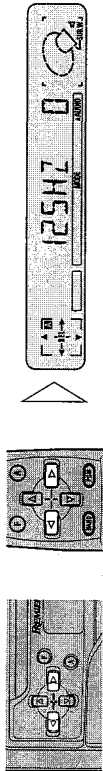

3. Increase or decrease the output level.

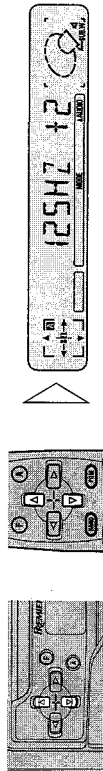

The display shows "+6" - "-6".

To cancel the Audio Menu, press the BAND button.

Note:

- You cannot select the 80HZ 0 mode (Sub-woofer setting mode) if Sub-woofer output is switched OFF in the SUB.W mode.

Audio Adjustment

F.I.E. Function

The F.I.E. (Front Image Enhancer) function is a simple method of enhancing front imaging by cutting mid- and high-range frequency output from the rear speakers, limiting their output to low-range frequencies.

Precaution:

- When the F.I.E. function is deactivated, the rear speakers output sound in all frequencies, not only bass sounds. Reduce the volume before disengaging F.I.E. to prevent a sudden increase in volume.

1. Select the **F.I.E. mode (FIE)** in the Audio Menu.

2. Switch the **F.I.E. function ON or OFF.**

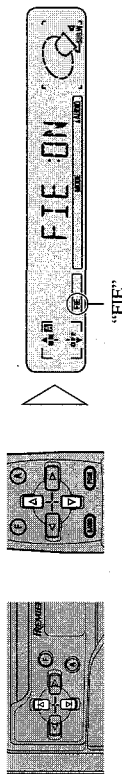

"FIE"

To cancel the Audio Menu, press the **BAND** button.

Note:

- After switching the F.I.E. function ON, select the FAD mode in the Audio Menu, and adjust front and rear speaker volume levels until they are balanced. (See page 99.)
- Switch the F.I.E. function OFF when using a 2-speaker system.

Volume Attenuator

The Attenuator reduces the volume instantly.

- **Cut the volume by about 90%.**

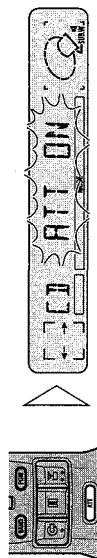

Repeat the preceding operation to return to previous volume.

Note:

- If the (+) or (-) buttons are used to cancel the Attenuator mode, the sound will resume at a lower volume than before.

Initial Setting

Entering the Initial Setting Menu

With this menu, you can perform initial settings for the unit.

1. **Switch the sources OFF.**
2. **Enter the Initial Setting Menu with the sources OFF.**

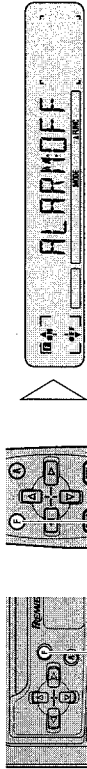

Hold for 2 seconds

Hold for 2 seconds

3. **Select the desired mode.**

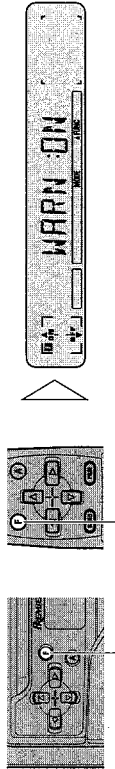

Each press changes the mode ...

Each press changes the mode ...

Each press of the **FUNCTION** button selects the mode in the following order:

ALARM → WARN → DIM

To cancel the Initial Setting Menu, press the **BAND** button.

Note:

- **ALARM** is a new feature "Detachable Face Security Alarm". Refer to "DFS Alarm Function" for details and instructions on how to use this function.
- Holding down the **FUNCTION** button for 2 seconds also cancels the Initial Setting Menu.

DFS Alarm Function

In addition to the Detachable Face Security, Pioneer has incorporated a new feature "Detachable Face Security Alarm". This feature is designed to protect your new Pioneer car stereo as well as your vehicle contents.

Activating the DFS Alarm Feature

Pioneer has developed a menu display that allows you to set-up your DFS Alarm to meet your personal needs. By scrolling through this menu it is possible to select your own "Entry Delay Time", "Speaker Output Volume", "Selectable Output", "Door System Type", "Starter Disable" and "Remote Djsarm".

Initially from the factory the DFS Alarm feature is not activated.

1. Select the DFS Alarm Feature ON/OFF mode with the sources OFF.

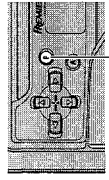

Hold for 2 seconds

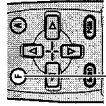

Hold for 2 seconds



2. Activate the DFS Alarm Feature.

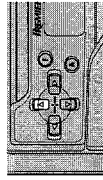

Press the ▼ button to deactivate the DFS Alarm Feature.

3. Enter the DFS Alarm Setting Menu.

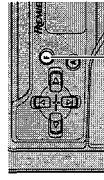

Hold for 2 seconds

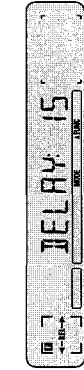

Setting the Warning Tone

You can switch the Warning Tone function ON/OFF.

1. Select the Warning Tone mode (WARN) in the Initial Setting Menu.

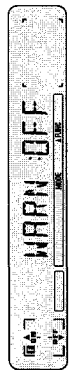
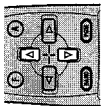
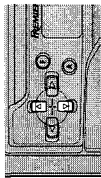

2. Switch the Warning Tone ON or OFF.

To cancel the Initial Setting Menu, press the BAND button.

Setting the Dimmer

To prevent this display becoming too bright at night, it is automatically dimmed when you switch on your vehicle's headlights. You can switch the dimmer ON/OFF.

1. Select the Dimmer mode (DIM) in the Initial Setting Menu.
2. Switch the Dimmer ON or OFF.

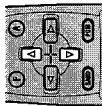
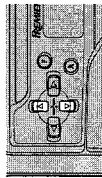

To cancel the Initial Setting Menu, press the BAND button.

DFS Alarm Function

Setting Entry Delay Time

Initially the "Entry Delay Time" is set to 15 seconds. The "Entry Delay Time" can be adjusted to be 0, 5, 15, 30, 45 or 60 seconds.

1. Decrease or increase the "Entry Delay Time".

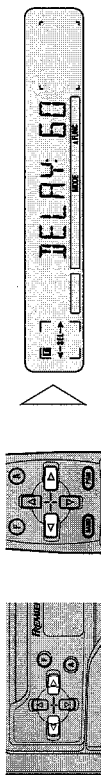

Display shows 0, 5, 15, 30, 45, or 60.

2. Advance to next selection.

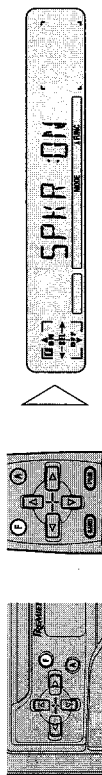

Activating Internal Speaker ON/ OFF

This feature allows you to select whether or not the speaker output is sounded when the "DFS Alarm" is triggered. Initially from the factory the speaker output is activated. Toggling between ▲, ▼ buttons allows you to deactivate or activate the "Internal Speaker". If you switch the speaker output OFF, you can not change the "TEST MODE".

Speaker Volume Output Adjustment

If the "Internal Speaker Output" has been selected then it is possible to adjust the volume of the speaker output for when the Alarm is triggered. To adjust the volume you must engage the "TEST MODE".

- Note:**
- If the "Internal Speaker Output" is turned OFF, then this menu will not appear.

1. Engage the "TEST MODE".

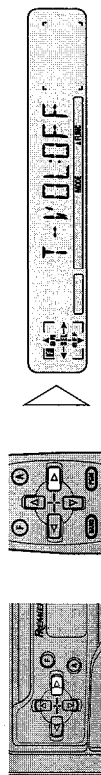

Continued overleaf.

2. Activate the "TEST MODE".

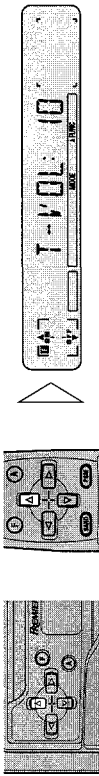

In this mode the speakers will sound.

3. Decrease or increase the volume.

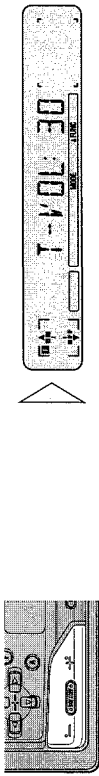

Display shows 10 - 30.

4. After selecting your preferred volume setting, deactivate the "TEST MODE".

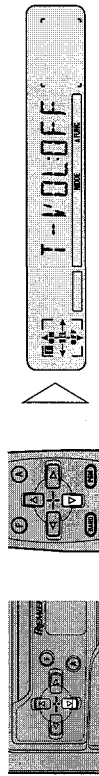

5. Cancel the "TEST MODE".

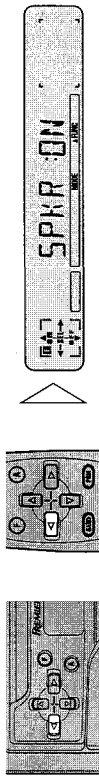

6. Advance to next selection.

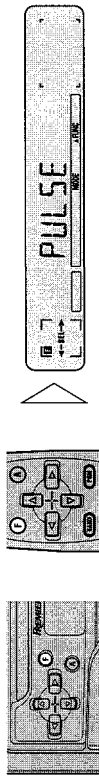

DFS Alarm Function

■ **Door System Confirmation**

The door system confirmation feature was incorporated to ensure that the correct door system type has been selected. (eg. Set to "DR-L:CLS" for GM vehicles.)

1. First, close all the doors. If the correct door system type has been selected then the Display will show "DR-L:CLS".

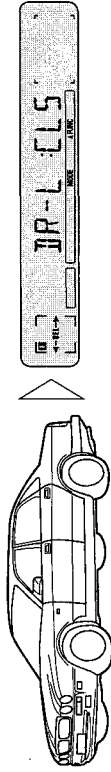

If not, select the alternative door system type by pressing the ◀ or ▶ button. Lastly, confirm each door triggers the Alarm by opening and closing each door.

2. As the door is opened the display should change accordingly ("DR-L:CLS" - "DR-L:OPN").

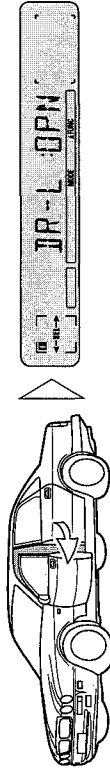

3. Advance to next selection.

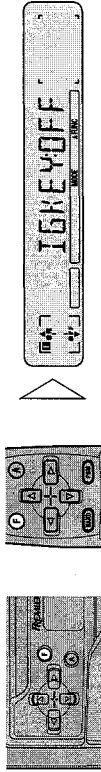

Setting the Selectable Output (Pulse/Constant)

This mode enables you to select a "Constant" output or "Pulsed" output. When connecting a Siren the "Constant" output should be selected. When connecting the horn or lights the "Pulsed" output should be selected.

1. Select your desired output type.

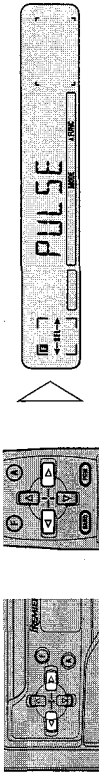

2. Advance to next selection.

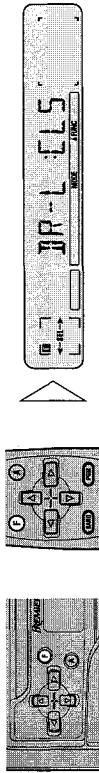

Selecting Door Switching Systems

It is necessary to select the correct "Door System Type" (Negative or Positive switching) for that of your vehicle. Initially, the system is set for vehicles with the grounding type (Negative switching). Select the correct "Door system type" of your vehicle from below.

- **Vehicles to select "DR-L:CLS"**
GM, CHRYSLER, EUROPEAN, JAPANESE

- **Vehicles to select "DR-H:CLS"**
FORD, JAGUAR, MERCEDES*, etc.

* Some Models Only.

- Select "DR-L:CLS" or "DR-H:CLS" for the correct door system type.

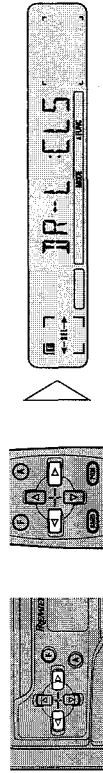

DFS Alarm Function

Central Door Lock Systems

The DFS Alarm can be disarmed by Un-Locking the doors with a remote key-less entry system. If the unit's stand-by state is disarmed, the LED's blinking speed becomes faster. (It can be understood if the "DFS Alarm" has been disarmed by the change in the LED's blinking speed.)

Note:

- If the "DFS Alarm" is disarmed by the key-less entry system, it will remain disarmed. To reset, turn the ignition on after reattaching the face, then turn the ignition to the off position and remove the detachable face.
- If your vehicle is equipped with a central door lock but the glass or shock sensor is not connected, if the window is broken and the central door lock is released, this unit's DFS Alarm will not operate.
- Pioneer recommends that both a shock sensor and glass sensor be installed when you are using the "Remote Disarming" feature.

Selecting the Door Lock Type

- Select the "LCK-L:CLS" or "LCK-H:CLS" for the correct door lock type.

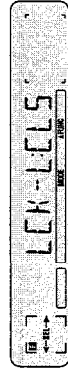
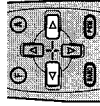
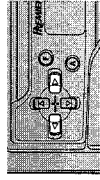

Door Lock Confirmation

The door lock confirmation feature was incorporated to ensure that the correct door lock type has been selected. (eg. Set to "LCK-L:CLS".)

1. As the doors are unlocked with central door lock system the display should flash "LCK-L:OPN" accordingly.



If not, select the alternative door lock type by pressing the ◀ or ▶ button.

Starter Disable

This function makes it virtually impossible for a would be thief to start your car when activated. This function is initially set "OFF". If a "SPDT" relay, sold separately, is installed it can be used. The method for disarming the "DFS Alarm" differs on whether or not this function is "ON" or "OFF".

■ If this function is "ON" or "OFF":

The "DFS Alarm" can be disarmed if the Detach face is reattached within the "Entry Delay Time".

■ If this function is "ON":

The "DFS Alarm" can be disarmed if the ignition key is inserted in the ignition within the "Entry Delay Time", then the key is turned from "OFF" to "ON" 5 times within 1 minute.

■ If this function is "OFF":

The "DFS Alarm" can be disarmed if the ignition key is inserted in the ignition and turned from "OFF" position to the "ON" within the "Entry Delay Time".

Note:

- In order for the "DFS Alarm" to operate when a window is broken, connect this unit's White/Red (ALARM SENSOR) lead to glass sensor securely.
- In order for the "DFS Alarm" to operate when a door is forced open, connect this unit's White (DOOR SWITCH) lead securely.

1. Activate the Starter disable function.

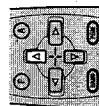
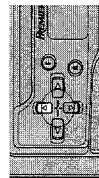

Press the ▼ button to deactivate the Starter disable function.

2. Advance to next selection.

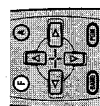
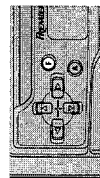

DFS Alarm Function

Disarming Alarm

Upon entering your vehicle, and within the "Entry Delay Time" set within the "DFS Alarm Menu", attach your Pioneer Detachable Face.

■ **If you have forgotten the Detachable Face Panel:**

If the "Starter Disable" is "ON", insert the ignition key in the ignition within the "Entry Delay Time", then turn the key from "OFF" to "ON" 5 times within 1 minute.
If the "Starter Disable" is "OFF", insert the ignition key in the ignition and turn the key from "OFF" to "ON" within the "Entry Delay Time".

CAUTION

- If the starter motor will not run, the cause may be the DFS Alarm. To check whether the DFS Alarm is the cause, try switching the position of the switch installed according to the "Avoiding Trouble" section of the installation manual.
- If the DFS Alarm is the cause of the trouble, then the starter motor will run. In this case, confirm DFS Alarm operation in a safe place. If there is no problem, switch the switch back to its original position. If left at the newly switched position, some functions of the DFS Alarm will not operate.
- If the starter motor will not run after switching the switch, something other than the DFS Alarm may be causing the problem. Have the vehicle checked.

Entry Detection

If the "DFS Alarm" was not disarmed in accordance with "Disarming Alarm", the "DFS Alarm" will be triggered. The "DFS Alarm" will sound for 60 seconds and will repeat 5 times if any door is left open or reopened. After the fifth time the "DFS Alarm" will reset to prevent continuous sounding and prevent your battery from discharging.

Precaution:

- Upon returning to your vehicle and before opening any doors, check to see if the LED indicator is still flashing. If the LED is no longer flashing, it indicates that the Alarm as sounded. Disarming, as described above, is still necessary.

2. **Cancel the DFS Alarm Setting Menu.**

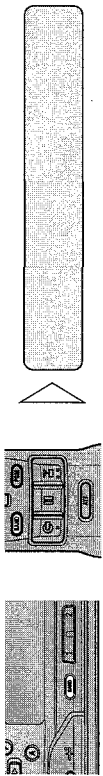

Setting of the "DFS Alarm" is now complete.

Note:

- In the case that the battery is disconnected or the RESET button is pressed, it may be necessary to re-program the DFS Alarm Menu; otherwise this setting needs to be done only once.
- When the DFS Alarm is armed, you cannot disarm it by pressing the RESET button.

Operation of "DFS Alarm"

Providing the installation and setting of the "DFS Alarm Setting Menu" has been performed correctly, operation of the "DFS Alarm" is very simple.

Arming Alarm

To arm your Alarm simply turn off the ignition and detach the front panel. After detaching the front panel the "DFS Alarm" will automatically arm itself after 30 seconds, providing all of the doors are closed. If after 30 seconds, a door still remains open the DFS Alarm will not arm until the last door has been closed. After closing all of the doors, ensure that they are securely locked. The LED indicator on the head unit will flash as a visual deterrent. Your vehicle is now protected by your "DFS Alarm".

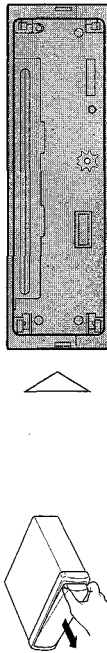

Other Functions

■ **Synchronizing with the Time Announcement**

- While holding down the DISP button for at least 2 seconds, press button 3 to reset the minute and second indications to zero.

Example: When synchronizing between 1:30 and 2:29.

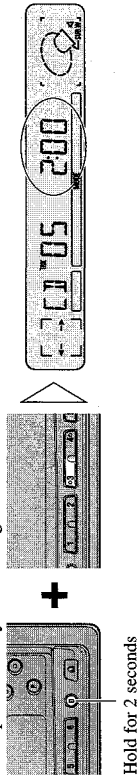

Other Functions

Time Display/Setting

■ **Displaying the Time**

- To turn the time display ON with the source ON.

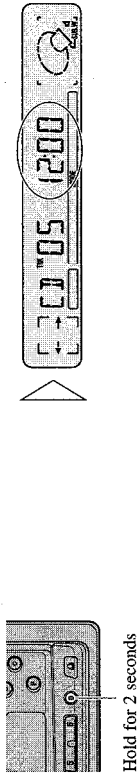

The time display disappears temporarily when you perform another operation, but the time indication returns to the display after 25 seconds.

■ **Setting the Hours**

- While holding down the DISP button for at least 2 seconds, press button 1 to set the hour.

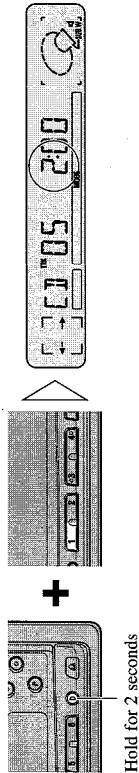

■ **Setting the Minutes**

- While holding down the DISP button for at least 2 seconds, press button 2 to set the minute.

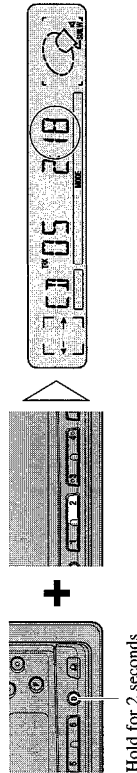

Hold for 2 seconds

When you release the DISP button, the second count begins from 00 seconds.

Note:

- The hour and minute can be advanced by pressing the respective buttons either consecutively or continuously.

