

DENON

Hi-Fi Component

For Europe
And U. K. Models

SERVICE MANUAL

MODEL DCD-625

MODEL DCD-625G

STEREO CD PLAYER

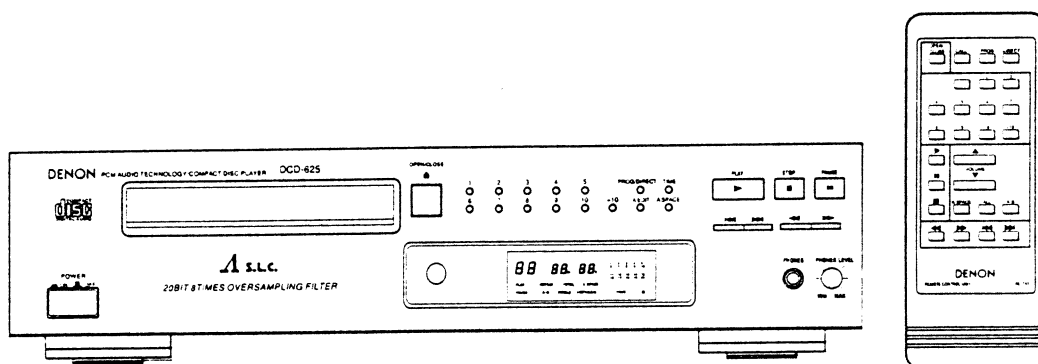

— TABLE OF CONTENTS —

OPERATING INSTRUCTIONS	2 - 8
DISASSEMBLY	9, 10
CONFIRMING METHOD OF SERVO	11 - 13
TEST METHOD FOR HEAT RUN MODE	14
NOTE FOR HANDLING OF THE LASER PICK-UP	15 - 19
SEMICONDUCTORS	20 - 24
NOTE FOR PARTS LIST	25
PARTS LIST OF PRINTED WIRING BOARD	26, 27
PRINTED WIRING BOARD	28, 29
EXPLODED VIEW OF CHASSIS AND CABINET	30
PARTS LIST OF EXPLODED VIEW	31
EXPLODED VIEW OF CD MECHANISM UNIT	32, 33
PARTS LIST OF CD MECHANISM UNIT	32, 33
WIRING DIAGRAM	34
SCHEMATIC DIAGRAM	35

NIPPON COLUMBIA CO., LTD.

FRONT PANEL
VORDERSEITE
PANNEAU AVANT
PANNELLO FRONTALE

PANEL ANTERIOR
VOORPANEEL
FRONT PANELEN
PAINEL FRONTAL

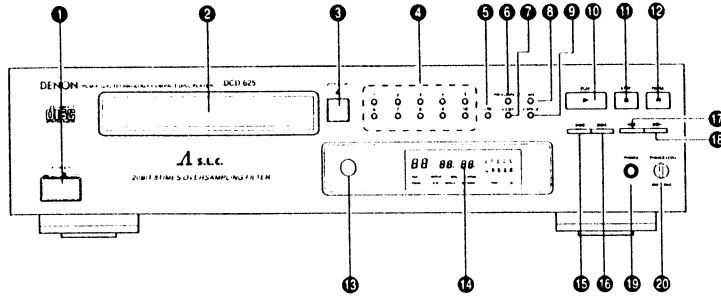

REAR PANEL
RÜCKSEITE
PANNEAU ARRIÈRE
PANNELLO POSTERIORE

PANEL POSTERIOR
ACHTERPANEEL
BAKSIDAN
PAINEL TRASEIRO

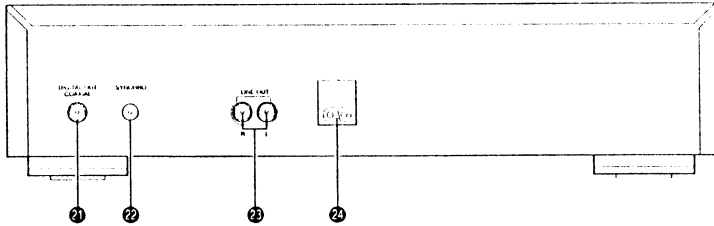

• NUR FÜR EUROPÄISCHE MODELLE

Konformitätserklärung

Die DENON Elektronik GmbH
Halskestr. 32
40880 Ratingen

erklärt als Hersteller/Importeur, daß das in dieser Bedienungsanleitung beschriebene Gerät den Technischen Vorschriften für Ton- und Fernseh-Rundfunkempfänger nach der Amtsblattverfügung 868/1989 (Amtsblatt des Bundesministers für Post und Telekommunikation vom 31.8.1989) entspricht.

Thank you for purchasing this DENON Compact Disc Player. Please read the operating instructions thoroughly in order to acquaint yourself with the CD player and achieve maximum satisfaction from it.

FEATURES

- TABLE OF CONTENTS -

FEATURES 4
 NAMES AND FUNCTIONS OF PARTS 5, 6
 CONNECTION 6, 7
 OPENING AND CLOSING THE DISC HOLDER AND LOADING A DISC 7
 NORMAL CD PLAYBACK 8
 ADVANCED CD PLAYBACK 8 - 10
 TIMER CONTROLLED PLAYBACK 10
 THE COMPACT DISC 11
 PLAYBACK USING THE REMOTE CONTROL UNIT 11, 12
 INSTALLATION PRECAUTIONS 13
 TROUBLESHOOTING 13

Please check to make sure the following items are included with the main unit in the carton:

- (1) Operating instructions 1
- (2) Connection Cord 1
- (3) Remote Control Unit RC 241 1
- (4) R03 AAA Dry Cell Battery 2
- (5) AC Cord 1

The DCD 625 Compact Disc Player incorporates DENON's Super Linear Converter which prevents deterioration of sound quality in PCM playback systems. This assures accurate reproduction of the digital signals recorded on compact discs no matter whether they are pure studio recordings or "live" performance recordings. All parts making up this CD player have been selected with the greatest care in order to produce high quality realistic playback of the full musical content on compact discs.

(1) Double Super Linear Converter

The use of Denon's unique system and D/A converters with excellent resolution to prevent zero cross distortion, the main cause of reduced sound quality in the PCM playback system, make for sound field reproduction with rich musical expression.

(2) High Performance Digital Filter

The DCD 625 uses independent D/A converters for the left and right channels and an 8x oversampling high precision digital filter to bring out the best of the analog filter and offer clear, crisp sound.

(3) Simple Playback of 8cm CD Singles

8cm CD singles can be played without using an adaptor.

(4) Wireless Remote Control Accessory

In addition to general operations such as Play, Stop and Pause, this remote control unit enables direct selection, direct programming, and other functions. Use of the remote control unit adds greatly to the operating ease of the DCD 625, enhancing its outstanding features.

(5) Synchronized Recording Function

Connect the SYNCHRO jack with a DENON cassette deck which is equipped with a SYNCHRO jack, then make a synchronized recording.

NAMES AND FUNCTIONS OF PARTS

1 Power Switch (POWER)

- When the power is turned on, "00" appears on the TRACK NO. display, and if no disc is loaded, "00000" appears on the digital display.
- If the power is turned on with a disc already loaded, the total number of tracks on the disc is displayed on the TRACK NO. display, the total time is displayed on the TIME display, the numbers on the music calendar light up to the number of tracks on the disc, and playback begins.
- Whenever the power switch is in the OFF state, the apparatus is still connected on AC line voltage. Please be sure to unplug the cord when you leave home for, say, a vacation.

2 Disc Holder

- Place the disc on the disc holder with the label facing up.
- Use the open/close button (△ OPEN/CLOSE) to open and close the disc holder.
- The disc holder may also be closed by pressing the play button (▶ PLAY) or pause button (⏸ PAUSE).

3 Open/Close Button (△ OPEN/CLOSE)

- The disc holder is opened and closed by pressing this button.
- Press this button once to open the disc holder, and once again to close it.
- When the disc holder is closed with a disc loaded, the disc will rotate for a couple of seconds while the disc contents are read. The number of tracks and total playback time on the disc are then displayed on the digital display.

4 Number Buttons (1, 2, 3, 4, 5, 6, 7, 8, 9 and 10)

- Use these buttons for the direct search and program memory functions.
- For direct search, press for example button 3 if you want to hear track number 3. For track number 12, press [10] then [2]. To program tracks, press the PROG/DIRECT button to set to the program mode.

5 +10 Button (+10)

- Press this button first when selecting track number over 10. Use it together with the number buttons. For example, to select track number 15, press [10] then [5].
- For track number 33, press [10] three times, then press [3].

6 Program Button (PROG/DIRECT)

- Press this button when you want to enter tracks for programmed playback. (Refer to page 8, 9 for details.)

7 Auto Edit Button (A, EDIT)

- The tracks on a CD are automatically split into two halves. Side A and Side B, like an analog disc, with the division at the place between tracks which is closest to 1/2 the total playing time, and with the tracks remaining in the same order.
- When this button is pressed in the stop mode, the total playing time for the first half and the track numbers on the calendar are displayed for approximately 2 seconds. Next, the same is done for the second half, after which the unit is automatically set to the pause mode at the beginning of the first track of the second half which was previously displayed. When the PLAY or PAUSE button is pressed again, playback begins, and the unit is automatically set to the stop mode at the end of the last track on the disc.
- This function will only work for discs with a total of 20 tracks or less. Also, when this function is used the mode is automatically set to the program mode, so direct search is not possible.

- The auto edit function is cleared when the STOP button is pressed.
- The data for the total playing time recorded on the disc and the actual total playing time of the tracks differ, so there may be a difference between the time displayed in the stop mode (the total playing time) and the total of the times of the first and second halves in the auto edit mode (about 2 seconds).

8 Time Mode Button (TIME)

- This button is used to select the desired indication on the TIME display. The indication on this display will change each time the button is pressed. Normally, the elapsed playback time of the current track is displayed. Pressing the button once, [REPEAT] is displayed and the remaining time of the current track is displayed. Pressing once more, [TOTAL] is displayed, and total playing time of remaining tracks is displayed. However, when programmed play is in progress, the total remaining time of the program is displayed. Press the button once again to return to the normal display of the elapsed playback time of the current track.

9 Auto Space Button (A, SPACE)

- Pressing this button will cause the [A SPACE] indicator to light and a blank space of approximately 4 seconds is inserted between tracks during CD playback. Pressing the button once more, the [A SPACE] indicator goes out and the Auto Space feature is cancelled.
- When one of the track search buttons (← or →) is pressed, the Auto Space function will not operate.
- The Auto Space function will work during normal playback as well as programmed playback.
- Although 4-second blanks are inserted between tracks, this additional time is not reflected by the indication on the time remaining display or time display when the Auto Edit function is engaged.

10 Play Button (▶ PLAY)

- Press this button to start playback of a disc.
- When this button is pressed, [PLAY] is displayed, and the track number being played is displayed together with the elapsed playback time of the track.
- Tracks are shown on the calendar display. Once a track has been played, the corresponding track number goes out on the calendar display.

11 Stop Button (■ STOP)

- Press this button to stop playback. This disc will stop rotating, and the number of tracks and total playing time of the disc are displayed on the TRACK NO. and TIME displays, respectively.
- In case programmed playback is engaged when this button is pressed, the number of tracks and total playing time of the program are displayed.

12 Pause Button (⏸ PAUSE)

- Press this button to stop playback temporarily.
- If this button is pressed during playback, playback is stopped temporarily, the [PLAY] indicator goes out and the [PAUSE] indicator lights.
- Press this button or the play button (▶ PLAY) again to continue playback.

13 Remote Control Sensor (REMOTE SENSOR)

- This sensor receives the infrared light transmitted from the wireless remote control unit.
- For remote control, point the supplied remote control unit RC-241 towards this sensor.
- When a signal is transmitted from the remote control unit, the remote control indicator in the display will light up briefly.

14 Display

- The digital display is divided into sections, such as displays for track number, playback time and calendar, as shown below.

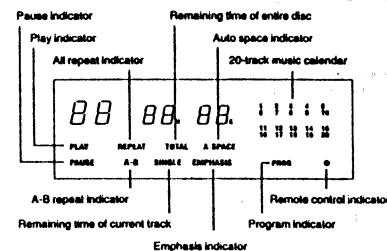

15 Automatic Search Reverse Button (←←)

- Press this button to return the pickup to the beginning of the present track. Press again to return to other tracks.
- By pressing the button a number of times, the pickup will move back the corresponding number of tracks.

16 Automatic Search Forward Button (→→)

- Press this button to move the pickup forward to the beginning of the next track. Press again to move ahead to other tracks.
- By pressing the button a number of times, the pickup will advance the corresponding number of tracks.

17 Manual Search Reverse Button (←←)

- Press this button during playback for fast reverse search. As long as the button is kept pressed, music signals are played back faster than normal.
- Pressing this button when the pause mode is engaged, you can quickly reverse the pickup to a desired position, three times faster compared to manual reverse search during playback. During this time, no sound is heard.

18 Manual Search Forward Button (→→)

- Press this button during playback for fast forward search. As long as the button is kept pressed, music signals are played back faster than normal.
- Pressing this button when the pause mode is engaged, you can quickly forward the pickup to a desired position, three times faster compared to manual forward search during playback. During this time, no sound is heard.

19 Headphones Jack (PHONES)

- For private listening, you can connect your headphones to this jack. Do not raise the volume level too much when listening through headphones. (Headphones are sold separately.)

20 Volume Control (PHONES LEVEL)

- Use this to adjust the output level of the headphones.

21 Digital Output Jack (COAXIAL)

- This jack outputs digital data.
- We recommend using a 75-ohm pin cord (available in stores) for connections.

22 SYNCHRO Jack

- To make a synchronized recording, this jack must be connected to the SYNCHRO jack of the deck with a connection cord. (See page 7 for connections.)

23 Output Terminal (LINE OUT)

- Connect these jacks to the input jacks on your amplifier. (Refer to page 6 for details on the connections.)

24 AC INLET

- Connect the included AC cord here.

Continuous Button Operation

If the automatic search reverse button, the automatic search forward button or the +10 button are held in, the function of that button will be repeated.

CONNECTION

(1) Connecting the Output Terminal (LINE OUT)

- Use the included pin cords to connect the left (L) and right (R) output terminal (LINE OUT) of the DCD-825 to the CD or AUX or TAPE PLAY left (L) and right (R) input jacks of the amplifier.

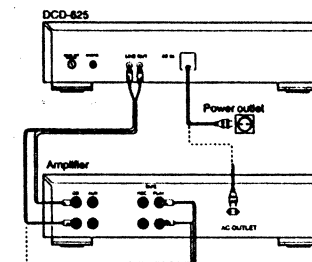

Connection Precautions

- Before proceeding with connections or disconnections of cables and power cords, be sure to turn all system components off.
- Ensure that all cables are connected properly to the L (left) and R (right) jacks.
- Insert plugs fully into the terminals.
- Connect the output jacks to the amplifier CD, AUX or TAPE PLAY input jacks.

(2) SYNCHRO Jack Connections

Connect the SYNCHRO jack with a DENON cassette deck which is equipped with a SYNCHRO jack, then make a synchronized recording. Use the connection cord supplied with the cassette deck. To make use of this function, also connect the output jacks and make the settings so that a recording can be made from the CD player to the cassette deck.

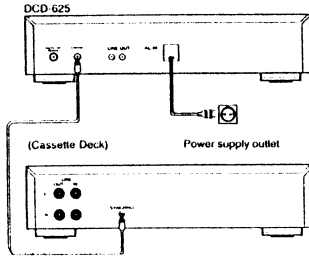
**(3) Connecting the Digital Output Jack (COAXIAL)**

Use a 75-ohm pin cord to connect the digital output jack (COAXIAL) of the DCD-625 to the digital input jack (COAXIAL) on a digital processor or D/A converter unit, available in stores.

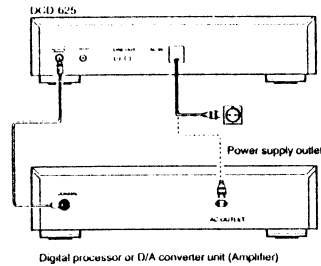
**OPENING AND CLOSING THE DISC HOLDER AND LOADING A DISC**

Opening and closing the disc holder (This operation only works while the power is on.)

1. Press the power switch (POWER) to turn on the power.
2. Press the open/close button (▲ OPEN/CLOSE).

How to load a disc

- Make sure the disc holder is completely open.
- Hold the disc by the edges and place it on the disc tray. (Do not touch the signal surface, i.e., the glossy side.)
- When using 12 cm diameter discs, make sure the outer edge matches the tray guide circumference (Fig. 1), and when using CD singles (8 cm diameter), match the outer edge with the inner tray guide circumference (Fig. 2).
- Press the open/close button (▲ OPEN/CLOSE) to close the disc holder.
- When the disc holder is closed, the disc is read and after a few seconds the number of tracks and total playing time are displayed on the TRACK NO. and TIME displays, respectively.
- When the disc holder is open and a disc is loaded, you may also press the play (▶ PLAY) or pause (⏸ PAUSE) button to close the disc holder. (If the play button (▶ PLAY) is pressed, playback will start immediately upon the disc contents having been read.)

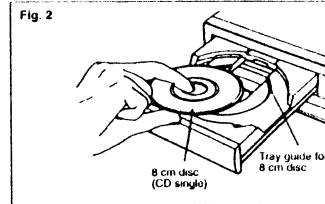
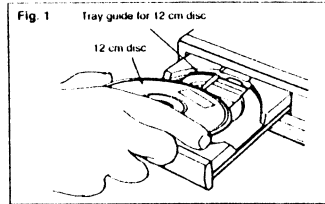
**Caution:**

- If your finger should get caught in the disc holder when it closes, press the open/close button (▲ OPEN/CLOSE).
- Do not place any foreign objects on the disc tray, and do not place more than one disc on the tray at a time. Otherwise malfunction may occur.
- Do not push in the disc tray manually when the power is off as this may cause malfunction and damage the CD player.

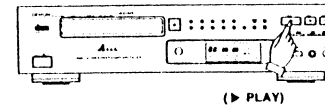
NORMAL CD PLAYBACK**(1) Starting Playback**

1. Press the power switch (POWER) to turn on the power.
2. Load the disc you want to play.
- When the disc holder is closed, the disc is read and the number of tracks and total playing time of the disc are displayed.
3. Press the play button (▶ PLAY).

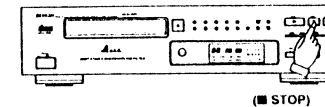
(2) Stopping Playback

1. Press the stop button (■ STOP).
- When all tracks have been played on a disc, playback will stop by itself.

Precautions:

- If no disc has been loaded or the disc has been placed upside down, all indicators will light.
- When the information on the disc cannot be read correctly, for example due to dust or dirt on the disc, the indicators will read as shown below. Nothing will be shown on the TRACK NO. and TIME displays, and it may take quite a while to read the disc.

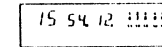

Normal display

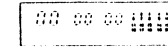

Improper display

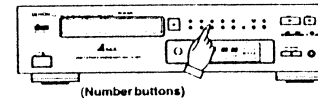
ADVANCED CD PLAYBACK**(1) Playing a Specific Track Direct Search**

- Use the number buttons and the +10 button to input the number of the desired track. For example, to play track number 4, press [4], and to play track number 12, press [+10] and [2]. Playback will begin from that track.

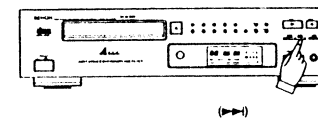
(2) Advancing to the next track during playback Automatic Search

- Press the Automatic search forward button (▶▶) during playback.
- The pickup will advance to the beginning of the next track and playback will continue. Pressing the button several times will forward the pickup the corresponding number of tracks.

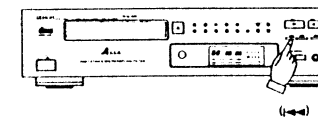
(3) Returning to the beginning of the current track during playback Automatic Search

- Press the Automatic search reverse button (◀◀) during playback.
- The pickup will return to the beginning of the current track and playback will continue. Pressing the button several times will return the pickup the corresponding number tracks.

(4) Playing Specific Tracks in a Specific Order Programmed Play

- With this function, you can choose any of the tracks on the disc and program them to play in any order.
- Programming is possible with the disc holder open.
- Up to 20 tracks can be programmed.
- The programmed tracks are shown on the calendar.

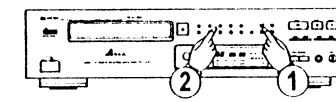
① Programming

(Number buttons)

(PROG/DIRECT)

- Press the PROG/DIRECT button so that the [PROG] indicator lights, then use the number buttons and the +10 button to program the tracks. For example, to program tracks 3, 12 and 7, press [PROG/DIRECT], [3], [+10] [2] and [7]. The corresponding track number light on the calendar each time a track is programmed, the track number is displayed on the TRACK NO. display, and the total playing time of the programmed tracks is displayed on the TIME display. A few seconds after the last track has been programmed, the total number of tracks programmed is displayed on the TRACK NO. display and the total playing time of the programmed tracks is displayed on the TIME display.

② Checking the Programmed Tracks

(Remote control only)

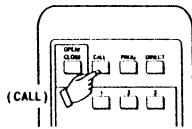

- Press the CALL button. The programmed tracks are displayed in order on the TRACK NO. display each time the CALL button is pressed.

③ Playing the Programmed Tracks

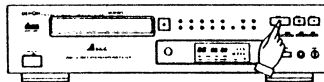

(▶ PLAY)

- Press the (▶ PLAY) button to play the tracks in the programmed order.

④ Clearing the program

- The entire program is cleared when the PROG/DIRECT button is pressed again. The program is also cleared when the (▲ OPEN/CLOSE) button is pressed.
- If the PROG/DIRECT button is pressed during programmed play, the program is cleared and playback continues normally through to the last track on the disc.

NOTES

- If programming is done in the play or pause mode, the track currently playing is programmed at the first position. Other tracks can be added to the program, but the number of programmed tracks and the playing time will not be displayed.
- Direct search is not possible during programmed play. If the number buttons are pressed, that track is added to the end of the program.
- Programming is possible with the disc holder open. Track numbers greater than the number of tracks recorded on the disc can be programmed, but will be automatically cleared before playback begins.
- The remaining time per track will only be displayed for track numbers 1 through 20.
- The total program time and remaining program time are not displayed if tracks greater than track number 20 are programmed.

(5) Pausing playback at any point

Pause

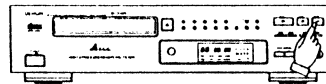

(|| PAUSE)

- Playback can be temporarily halted and then continued from the same point in the track.
- Press the pause button (|| PAUSE) during the playback.
- To continue playback, press the play button (▶ PLAY) or the pause button (|| PAUSE) once more.

(6) Audible quick search

Manual Search

- Using this function, you can cue to a desired point within a track, either in the forward or reverse direction.
- Release the manual search button (◀◀ or ▶▶) when the desired point has been reached. Normal playback then continues.

① Manual Search Forward

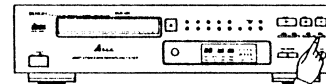

(▶▶)

- Press the manual search forward button (▶▶) during playback. Playback of the track is sped up.
- As a reference, the current track number and elapsed playback time within the track are displayed.
- Manual search forward is approximately three times faster when engaged during the pause state compared to playback. In this case, no sound is heard however.
- If the manual search forward button (▶▶) is kept pressed after the end of the final track on the disc is reached, (J) is displayed and manual search stops. To return to another point, press the manual search reverse button (◀◀) until (J) disappears.

② Manual Search In Reverse

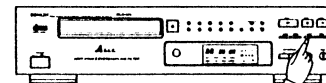

(◀◀)

- Press the manual search reverse button (◀◀) during playback. Reverse playback of the track is sped up.
- As a reference, the current track number and elapsed playback time within the track are displayed.
- Manual search in reverse is approximately three times faster when engaged during the pause state compared to playback. In this case, no sound is heard, however.
- If the manual search reverse button (◀◀) is kept pressed after the beginning of the first track on the disc is reached, (L) is displayed and manual search stops. To return to another point, press the manual search forward button (▶▶) until (L) disappears.

(7) Inserting blanks between tracks

Auto Space

- This is a convenient feature that will insert 4-second blanks between tracks, which can be used when recording compact discs on tape.

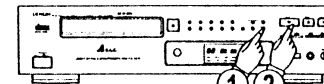

(A.SPACE) (▶ PLAY)

- Pressing the auto space button (A.SPACE) will cause the [A.SPACE] indicator to light.
- Press the play button (▶ PLAY) to start playback. When a track has been played to its end, a 4-second silence is made before the next track starts playing.
- Press the auto space button (A.SPACE) again to cancel the function.

(8) Searching and Pausing at the Beginning of the Track

Pause

① With Direct Search

- In this case, the set pauses at the beginning of the track found with the direct search operation.

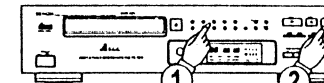

(Number buttons) (|| PAUSE)

- Press the number button(s) for the desired track.
- Press the (|| PAUSE) button.
- To start playback, press the (▶ PLAY) or (|| PAUSE) button.

② With Program Search

- Press the (|| PAUSE) button after the program search operation is completed. The set will pause at the beginning of the first programmed track.

(9) Synchronized Recording Function

Synchronized Recording Function

Connecting the SYNCHRO jack with a DENON cassette deck which is equipped with a SYNCHRO jack will allow synchronized recordings to be made.

- To use this function, be sure to connect the SYNCHRO jacks as well as the output jacks. (See page 7 for connections.) Then, load a disc. With the CD player in the stop or pause condition, starting a synchronized recording at the cassette deck side will automatically cause the CD player to start playing. (This is synchronized play.)
- The remote control signal receive indicator of the display will blink during synchronized play.

NOTE

- Synchronized play is also possible in the program mode.
- The repeat mode is cancelled when synchronized play is started.
- Except for the STOP, PLAY, TIME, A.SPACE and DISPLAY buttons, the buttons will not operate during synchronized play.
- To use this function in the AUTO EDIT condition, use the longer tape than total playing time of the disc.
- In the play condition, even if you start a synchronized recording at the cassette deck side, CD player will not synchronize with the cassette deck and the cassette deck becomes synchronized pause condition. In this case push the STOP button of the cassette deck, set the CD player in the stop or pause condition and start a synchronized recording at the cassette deck side again.

For further details, see the owner's manual for the cassette deck that has been connected.

TIMER-CONTROLLED PLAYBACK

■ Operation

- Turn on the power of all system components.
- Set the input selector on the amplifier to correspond to the inputs the CD player is connected to.
- Make sure a disc has been loaded in the disc holder.
- Check the time on the timer and then set the desired turn-on time.
- Turn the audio timer ON. Power is turned off automatically in all components connected to the timer.
- When the preset turn-on time is reached, power is turned on in the system components, and CD playback starts from the first track.

■ Connection

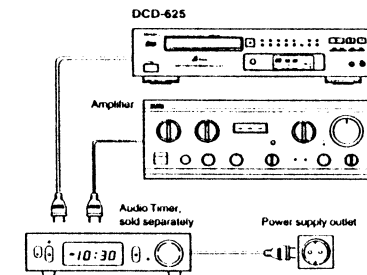

THE COMPACT DISC

1. Precautions on handling compact discs

- Do not allow fingerprints, oil or dust on the surface of the compact disc. If the signal surface is dirty, wipe it off with a soft, dry cloth. Wipe in circular motions from the center and out.
- Do not use water, benzene, thinner, record sprays, electrostatic proof chemicals, or silicone-treated cloth to clean discs.
- Always use care when handling discs to prevent damaging the surface, in particular when removing a disc from the case and returning it.
- Do not bend compact discs.
- Do not apply heat to compact discs.
- Do not enlarge the hole in the center of the disc.
- Do not write on the disc and do not attach any labels.
- Condensation will form on the disc surface if it is brought into a warm room from a cold area, such as outdoors during winter. Wait until the condensation disappears. Never dry discs with hair dryers, etc.

2. Precautions on storage

- After playing a disc, always return it to its case.
- Keep discs in the cases when they are not to be played. This will protect them from dust and dirt and prolong their service life.
- Do not store discs in the following places:
 - Places exposed to direct sunlight for a considerable time.
 - Places subject to accumulation of dust or high humidity.
 - Places exposed to high temperatures, such as close to heater outlets.

PLAYBACK USING THE REMOTE CONTROL UNIT

The accessory RC-241 remote control unit can be used to control the CD player from a convenient distance.

(1) Inserting the dry cell batteries

- Remove the battery cover on the back of the remote control unit.

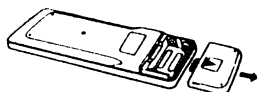

- Insert two R03 (standard size AAA) dry cell batteries with correct polarity as indicated inside the battery compartment.

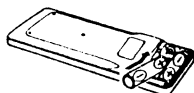

- Replace the battery cover.

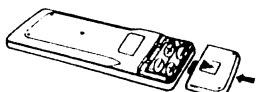

Notes on the Batteries

- The remote control unit uses standard size AAA dry cell batteries.
- The batteries will need to be replaced approximately once a year. Replacement may be necessary earlier depending on how much the remote control unit is used.
- If, in less than a year from the time new batteries were inserted, the remote control fails to operate the CD player from a near-by position, it is time to replace the batteries.
- Insert the batteries properly, following the polarity diagram inside the battery compartment, in other words make sure (+) and (-) terminals are properly aligned.
- Batteries are prone to damage and leakage. Therefore:
 - Do not combine new batteries with used ones.
 - Do not combine different types of batteries.
 - Do not jumper opposite poles of the batteries, expose them to heat, break them open nor expose of them in open fire.
- If the remote control unit is not to be used for a long period of time, remove the batteries from the unit.
- If the batteries have leaked, remove any traces of battery fluid from the battery compartment, wiping thoroughly with a dry cloth. Then insert new batteries.

(2) Directions for Use

- Operate the remote control unit while pointing it towards the remote control sensor on the CD player (see below). When a remote control signal is received, the remote control indicator on front of the CD player lights briefly.
- The remote control unit can be used at a distance up to 8 meters in a straight line from the CD player. This distance decreases if there are obstructions blocking the signal path or when the remote control unit is operated at an angle from the remote control sensor.
- The buttons on the remote control unit have identical functions with those on the CD player. However, the following functions cannot be remote controlled. Power ON/OFF.

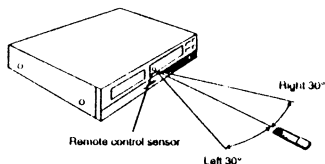

Notes on Operation

- Do not press identical buttons on the CD player and remote control unit simultaneously as this may cause malfunction.
- The remote control unit may be difficult to operate if the remote control sensor is exposed to strong light, such as direct sunlight or light from fluorescent lamps, or if there are obstacles between the remote control unit and the sensor.
- Direct track selection**
Using the track number buttons (1 - 10, +10), tracks can be directly assigned for playback.
- Track selection while programming**
Press the program button (PROG) and then the track numbers you wish to enter into the memory.
Example: PROG → 3 → +10 & 1 → 5 ...
(Tracks 3, 11, 5 and so on are entered into the memory.)
- Memorized tracks are erased by pressing the Direct button (DIRECT).
- Correct use of the track number buttons**
Direct selection of single-digit tracks is easy by just pressing the desired track number button. For tracks with numbers from 11 and on, first press the +10 button and then a single digit button. E.g., to select track 22, press the +10 button twice and then press the 2 button.

REMOTE CONTROL UNIT RC-241

Setting to the Program Mode

- For program search, press the PROG button then the numeric buttons (1 through 10 and +10).
- The remote control unit is normally set to the direct mode.

The level of the Output Terminal output can be varied. Pressing the (▲) button increases the volume and pressing the (▼) button decreases the volume.

Checking Programmed Contents
By pressing the CALL button on the remote control unit, programmed contents will be displayed. Tracks entered into the memory will be displayed starting from the first track entered, and will advance one step at a time each time the CALL button is pressed.

Track Selection
Use the numeric track buttons (1 - 10 and +10) while programming and to access a desired track almost instantly. The track search buttons (⏮ and ⏭) are best used to advance or return from the current track to the next track.

- Repeat All Tracks Button (ALL)**
Press this button to repeat playback of all tracks. When this button is pressed, [REPEAT] lights on the display and all tracks on the disc or in a program will be repeatedly played back. Press this button once more to disengage the Repeat All function.

• A-B Repeat button (A-B)

- Repeating playback of a desired interval**
- Start playback and press the A-B button when you reach the starting point of the interval. The [A B] indicator starts blinking.
 - Continue playback or advance the pickup using the Automatic Search Forward button (⏭) or Manual Search Forward button (⏮) until the ending point is reached. Then press the A-B button once more. The [A B] indicator will light.
- The pickup will now return to the starting point and repeat playback of the selected interval.
 - This interval will be repeated until the A-B repeat mode is cancelled by pressing the A-B repeat button. The [A B] indicator goes out.
 - A-B repeat playback is not possible during programmed playback.

INSTALLATION PRECAUTIONS

The CD player uses a microcomputer for controlling internal electronic circuits. In the event that the player is used while a near-by tuner or TV is turned on, although unlikely, interference could occur either in the sound from the tuner or the picture of the TV. To avoid this, please take the following precautions:

- Keep the CD player as far away from the tuner or TV set as possible.
- Keep the power cable and connecting cable of the CD player separate from the antenna wires of the tuner and TV.
- Interference is particular likely to occur when an indoor antenna or a 300-ohm feeder cable is used. Thus, use of an outdoor antenna and 75-ohm coaxial cable is strongly recommended.

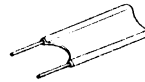

300-ohm feeder cable

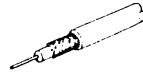

75-ohm coaxial cable

TROUBLESHOOTING

If the CD player does not seem to be functioning properly, check the following:

Disc holder does not open or close.

- Is the power on?

When a disc is loaded, 00 00 00 is displayed.

- Is the disc loaded properly? See page 7

When the play button (▶ PLAY) is pressed, playback does not start.

- Is the disc dirty or scratched? See page 11

There is no sound, or it is distorted.

- Is the output cord properly connected to the amplifier? See page 6
- Have the amplifier controls been set correctly?

A specific section of the disc will not play.

- Is the disc dirty or scratched? See page 11

Programmed playback does not work.

- Have programming been properly done? See pages 8, 9 and 12

Incorrect operation when buttons on the remote control are pressed.

- Is the remote control unit being operated too far from the CD player? See page 11
- Are there obstacles blocking the ray?
- Is the remote control sensor exposed to strong light?
- Are the batteries exhausted?

SPECIFICATIONS

AUDIO

No. of Channels:	2 channels
Frequency Response:	2 ~ 20,000 Hz
Dynamic Range:	98 dB
Signal-to-noise Ratio:	107 dB
Harmonic Distortion:	0.003% (1 kHz)
Separation:	100 dB (1 kHz)
Wow & Flutter:	Below measurable limit: (±0.001% W.peak)
Output Voltage:	0.2 ~ 2.0 V

DISCS

GENERAL CHARACTERISTICS

Power Supply:	50 Hz, ~ 230 V
Power Consumption:	10 W
Dimensions:	434 (17-3/32") W x 105 (4-1/8") H x 283 (11-5/32") D mm
Weight:	3.7 kg

FUNCTIONS AND DISPLAY

Functions:	Automatic search, programmed playback, repeat playback, manual search, auto space, time mode, auto edit
Display:	Track number, time, music calendar, emphasis feature and engaged modes
Others:	Headphone jack
REMOTE CONTROL UNIT	RC-241
Remote Control System:	Infrared Pulse System
Power Supply:	3 V DC; two R03 (standard size AAA) dry cell batteries
External Dimensions:	56 (2-13/64") W x 154 (6-1/16") H x 17 (43/64") D mm
Weight:	100 g (including batteries)

*Design and specifications are subject to change without notice in the course of product improvement.

DISASSEMBLY

1. LOADER PANEL

As removing front panel in power OFF status, use a screw driver to insert set Loader panel below hole and rotate counterclockwise ①, pull out disc table ②, then detach Loader panel ③.

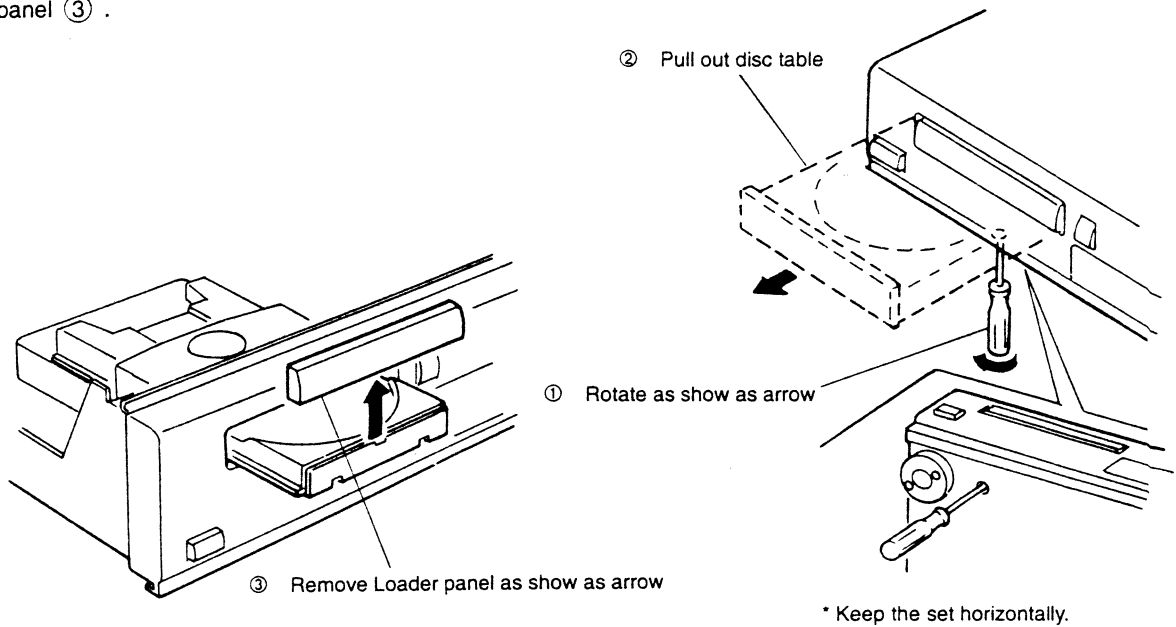

2. TOP COVER

1. Remove a Screw ④.
2. Remove 4 screws ⑤.

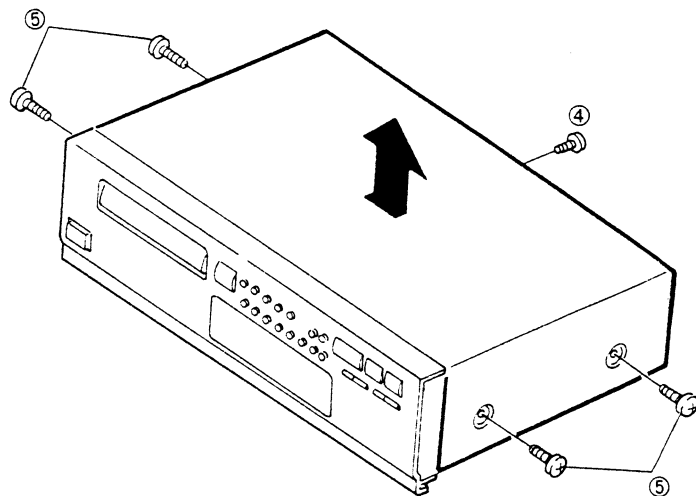

3. FRONT PANEL

1. Remove 2 screws ⑥ .
2. Remove 2 screws ⑦ and undo hooks at 3 places.

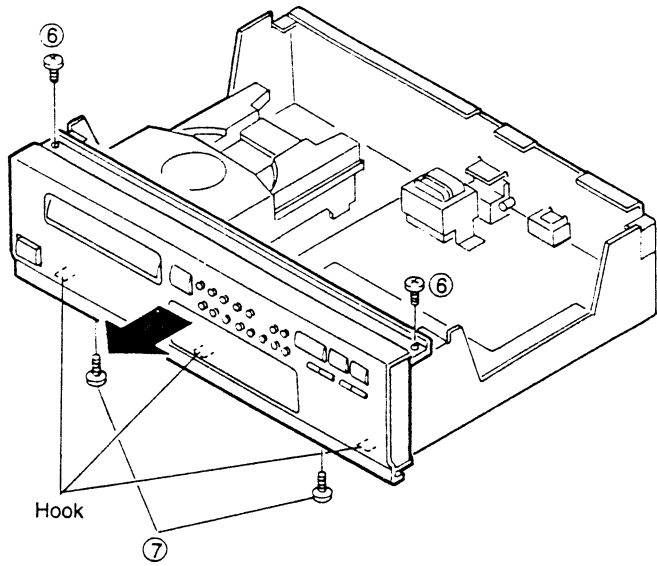

4. REAR PANEL

1. Remove 2 screws ⑧ .
2. Remove 2 screws ⑨ .
3. Remove 2 screws ⑩ .
4. Remove a screws ⑪ .

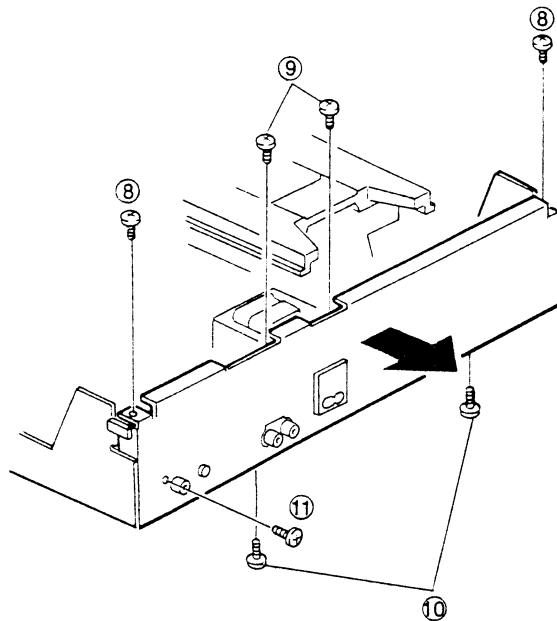

CONFIRMING METHOD OF SERVO

A microcomputer adopted to this unit has the service programs so as to perform confirming more easily with the operation buttons. Digital servo adopted to this unit is became automatic adjustment status in focus gain and tracking gain.

1. Actuating the Service Program

- (1) Turn power switch OFF.
- (2) Shortcircuit the main unit JV160 (OUT) to JV159 (GND).
Note: don't touch another connector pin.
- (3) Turn power switch ON.
(Service program start actuates and displays track No. 01)

Note: The operation buttons do not function when service program actuates.

2. Operation Function at Service Program Actuation

Button Operation	Operation Function	Explanation				
▲ OPEN/CLOSE	Opens or closes disc holder button.	<ul style="list-style-type: none"> ● Open or closes only when disc is stopped. ● Operate other keys after open or close. 				
■ STOP	Stops system function.	<ul style="list-style-type: none"> ● Displays track number 01. ● Press when adjustment completed or do it again. 				
▶ PLAY	Starts Focus servo and disc turns.	<ul style="list-style-type: none"> ● Press when tracking adjustment. ● When completed, displays track number 02. 				
PAUSE	Starts Focus servo, Tracking servo, Slide servo and Spindle servo.	<ul style="list-style-type: none"> ● Pressing PLAY button, starts Tracking servo and slide servo. ● When completed, displays track number 03. 				
1	Displays a result of Focus gain automatic adjustment.	<ul style="list-style-type: none"> ● After completed PAUSE operation, pressing Button 1 of 10-key indicates a result of Focus gain automatic adjustment. ● When completed, Display shows: <table style="margin-left: auto; margin-right: auto;"> <tr> <td style="text-align: center;">TRACK</td> <td style="text-align: center;">TIME</td> </tr> <tr> <td style="text-align: center;">1-</td> <td style="text-align: center;">VV VV XX XX</td> </tr> </table> TIME display shows automatic adjustment value. Displays: 01H27₅~00H01₅ or EEH01₅ 	TRACK	TIME	1-	VV VV XX XX
TRACK	TIME					
1-	VV VV XX XX					
2	Displays a result of Tracking gain automatic adjustment.	<ul style="list-style-type: none"> ● After completed PAUSE operation, pressing Button 2 of 10-key indicates a result of Tracking gain automatic adjustment. ● When completed, Display shows: <table style="margin-left: auto; margin-right: auto;"> <tr> <td style="text-align: center;">TRACK</td> <td style="text-align: center;">TIME</td> </tr> <tr> <td style="text-align: center;">2-</td> <td style="text-align: center;">VV VV XX XX</td> </tr> </table> TIME display shows automatic adjustment value. Displays: 01H27₅~00H01₅ or EEH02₅ 	TRACK	TIME	2-	VV VV XX XX
TRACK	TIME					
2-	VV VV XX XX					
Other Buttons	Unable to obtain normal function.	<ul style="list-style-type: none"> ● Never attempt to operate the buttons other than the above. ● If the buttons are erroneously pressed, promptly turn OFF the power switch. 				

(Caution)

- During the service program is in operation, do not use remote control.

3. Confirming Method

(1) Required Measuring Equipment

- 1) Dual-trace oscilloscope
- 2) Test disc: CA-1094

(2) Check Point

CD Mechanical unit PWB (pattern view)

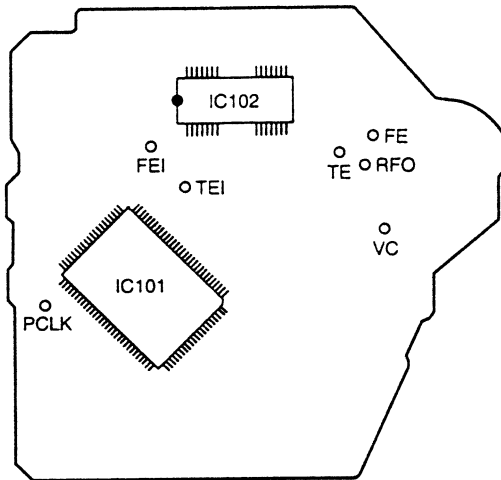

(3) Confirming Procedure

- 1) Actuate the service program.
- 2) Check the value of Focus gain automatic adjustment.
- 3) Check the value of Tracking gain automatic adjustment.
- 4) Check for Tracking offset.
- 5) Finish the service program and return the mode to normal operation (turn ON the power switch in normal manner).
- 6) Check for HF level.

(4) Confirming Focus Gain

- 1) Press **PAUSE** button. (Track No. indication **03**)
- 2) Press **1** button. (Track No. indication **1-**)
- 3) Check for automatic adjustment value.
Automatic adjustment value: 00M82s ~ 00M34s (normal temperature) (Test disc: CA-1094)
01M04s ~ 00M28s (0°C~40°C)

Note: As it is a possibility of abnormality in pick-up when automatic adjustment value is EEm01s or less than 00M27s, execute the confirmation for pick-up according to pick-up replacement standard.
If there is no abnormality in pick-up as described in pick-up replacement standard notes, no problem will occur for disc playback even though the automatic adjustment value is EEm01s or less than 00M27s.

(5) Confirming Tracking Gain

- 1) Press **PAUSE** button. (Track No. indication **03**)
- 2) Press **2** button. (Track No. indication **2-**)
- 3) Check for automatic adjustment value.
Automatic adjustment value: 00M81s ~ 00M23s (normal temperature) (Test disc: CA-1094)
01M03s ~ 00M18s (0°C~40°C)

Note: As it is a possibility of abnormality in pick-up when automatic adjustment value is EEm02s or less than 00M22s, execute the confirmation for pick-up according to pick-up replacement standard.
If there is no abnormality in pick-up as described in pick-up replacement standard notes, no problem will occur for disc playback even though the automatic adjustment value is EEm02s or less than 00M22s.

(6) Confirming Tracking Offset (E/F Balance)

Connection			
Oscilloscope		Check	Step
V	H	(Oscilloscope)	<ol style="list-style-type: none"> 1. Push ▲ OPEN/CLOSE button and load disc holder reference disk. 2. Push ▲ OPEN/CLOSE button and close disc holder. 3. Push ▶ PLAY button to turn disc. (Displays track number 02) 4. Short (+)(-) of oscilloscope and check the base line. 5. Confirm that upper and lower amplitude of the waveform is symmetric against 0V.
0.1v/div	1-2 ms/div	$\frac{A - B}{A + B} < 20\%$	

(7) Confirming HF Level

Connection			
Oscilloscope		Check	Step
V	H	(Oscilloscope)	<ol style="list-style-type: none"> 1. Push PAUSE button. (Displays track number 03) 2. Check HF level of oscilloscope. 3. Confirm that the waveform is in good shape. (eye pattern in center must be able to discriminate clearly.)
50mv/div or 20mV/div	0.2μ/div or 0.5μ/div	 	
<ul style="list-style-type: none"> • Set input mode to ALTERNATE or CHOPPER. 			

TEST METHOD FOR HEAT RUN MODE

1. Actuate

While hold pushing ►, ■ and || buttons simultaneously, turn the unit power on. The remote control sensor indicator will light to show that the unit is shifted in Heat Run mode.

Press the ▲ button to cancel Heat Run mode after loading disc.

2. Operation

1) Heat Run test

During the Heat Run mode to start in Play mode, it makes the unit replays from the first track after opens the loader when finishing with playing last track. After that, this operation is over again. When disc has over 21 tracks, makes the unit to search the last track and set operation times.

2) Checking test

Press **PAUSE** button 2 times in the Heat Run mode, it makes the unit opens the loader, turns the servo ON, reads out TOC, operates first track search and does over again.

3) Sound out test

During the Heat Run mode, press +10 button to start in Play mode. If it generates over ± 8 frame sound out, stop the operate and display the error message.

3. Error Message

When the system error occurs in the Heat Run mode, display the error message with TRACK and operated times with TIME.

- | | |
|-------------|--|
| 1) E1 error | Focus Servo does not activate. |
| 2) E2 error | GFS does not drive. |
| 3) E3 error | No GFS emit. |
| 4) E4 error | TOC is unreadable. |
| 5) E5 error | Does not turn the Loader switch ON. |
| 6) E6 error | Does not turn the Pick-up inner circle switch OFF. |
| 7) E7 error | Does not turn the Pick-up inner circle switch ON. |
| 8) E8 error | Sound out. |

NOTE FOR HANDING OF THE LASER PICK UP

Judgement standards for PICK-UP Replacement

1. PICK-UP REPLACEMENT

The pick-up(PU) replacement must be executed upon the following 4 items and found the abnormality in the PU.

When PU is abnormal, please write PU abnormality cause for PU sign column of connecting prompt report of market quality state clearly.

1) Judgement by confirming of Focus search

(cause of PU abnormality: Focus search does not function.)

2) Judgement by checking of changing PU due to Focus error signal V_{FE}

(cause of PU abnormality: No proper emission of focus error signal (s-curve) V_{FE})

3) Judgement by checking of changing PU due to Tracking Error signal V_{TE}

(cause of PU abnormality: No proper emission of tracking error signal (traverse waveform) V_{TE})

4) Judgement by checking of changing PU due to HF level V_{HF}

(cause of PU abnormality: No proper emission of HF waveform)

2. DISC TO BE USED FOR CONFIRMATION

Using disc: No. CA-1094

3. OTHER CAUSE OF PU CHANGING

If it happened other cause of PU replacement except the above-mentioned 4 items, please execute PU replacement and write this cause for connecting prompt report of market quality state in detail.

1. Judgement by Confirming of Focus Search (Check for focus search function of PU Lens)

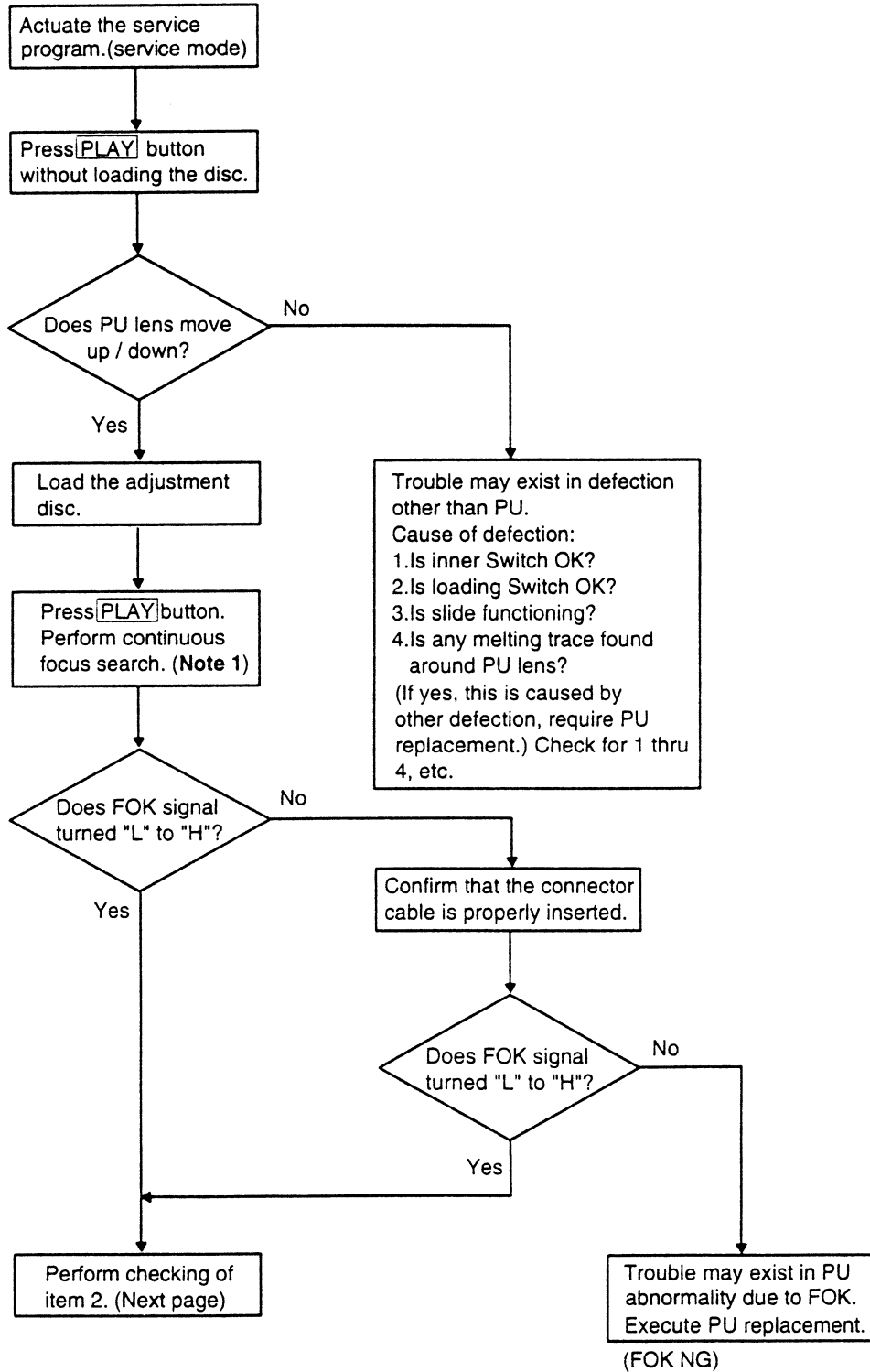

Note 1: Press [PLAY] button continually in FOK measuring.

2. Judgement by checking of changing PU due to Focus Error signal V_{FE} (check for proper S-curve)

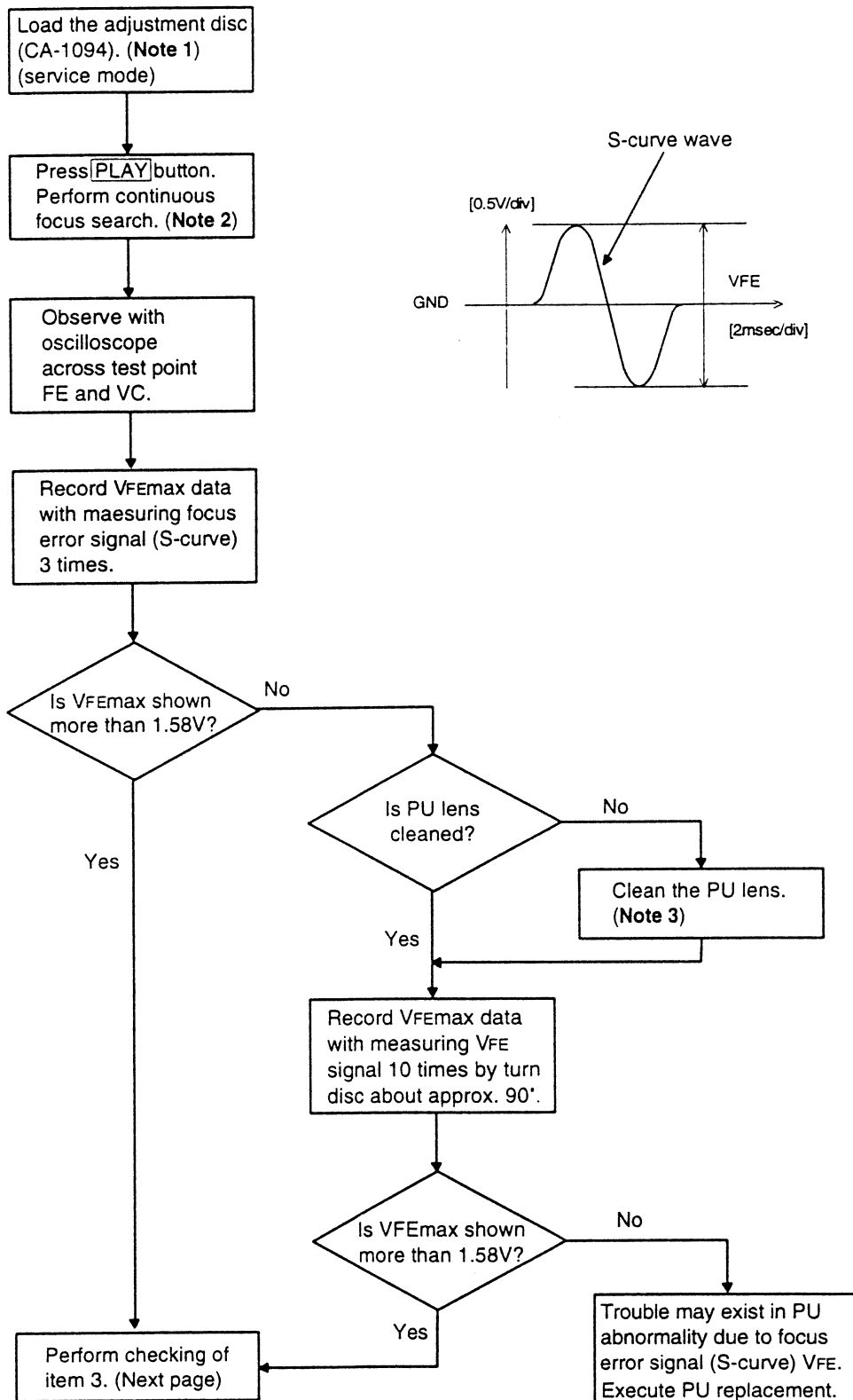

Note 1: Adjustment disc (CO-76143) $V_{FE} = 1.67 V$.

Note 2: Press **[PLAY]** button continually in VFE measuring.

Note 3: Gently wipe out the lens surface with a little amount of isopropyl alcohol soaked lens cleaning paper without apply excessive force to the lens.

3. Judgement by checking of changing PU due to Tracking Error Signal VTE (check for proper Traverse waveform)

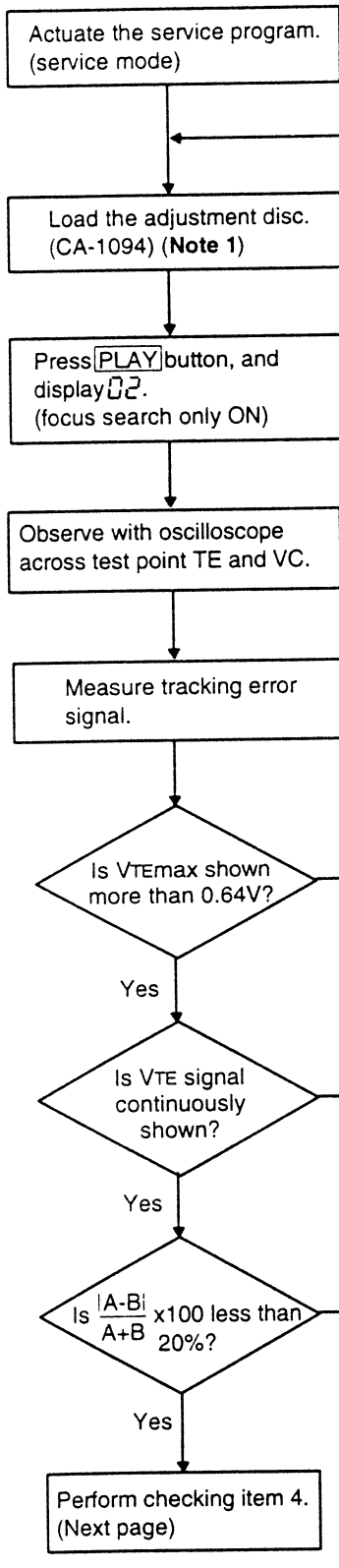

1. Tracking error signal level without undulation.

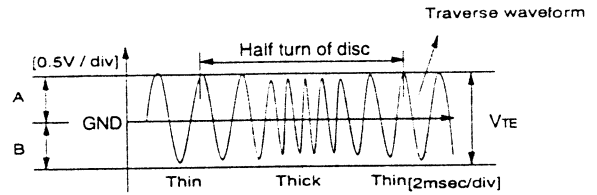

2. Tracking error signal level with undulation.

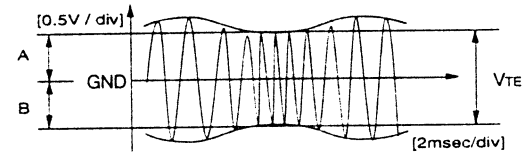

3. Occasionally no tracking error signal level.

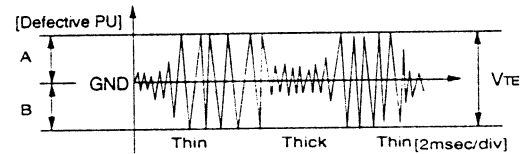

Note 1: Adjustment disc (CO-76143) VTE = 0.70 V.

4. Judgement by checking of changing PU due to HF level VHF (check for proper HF waveform)

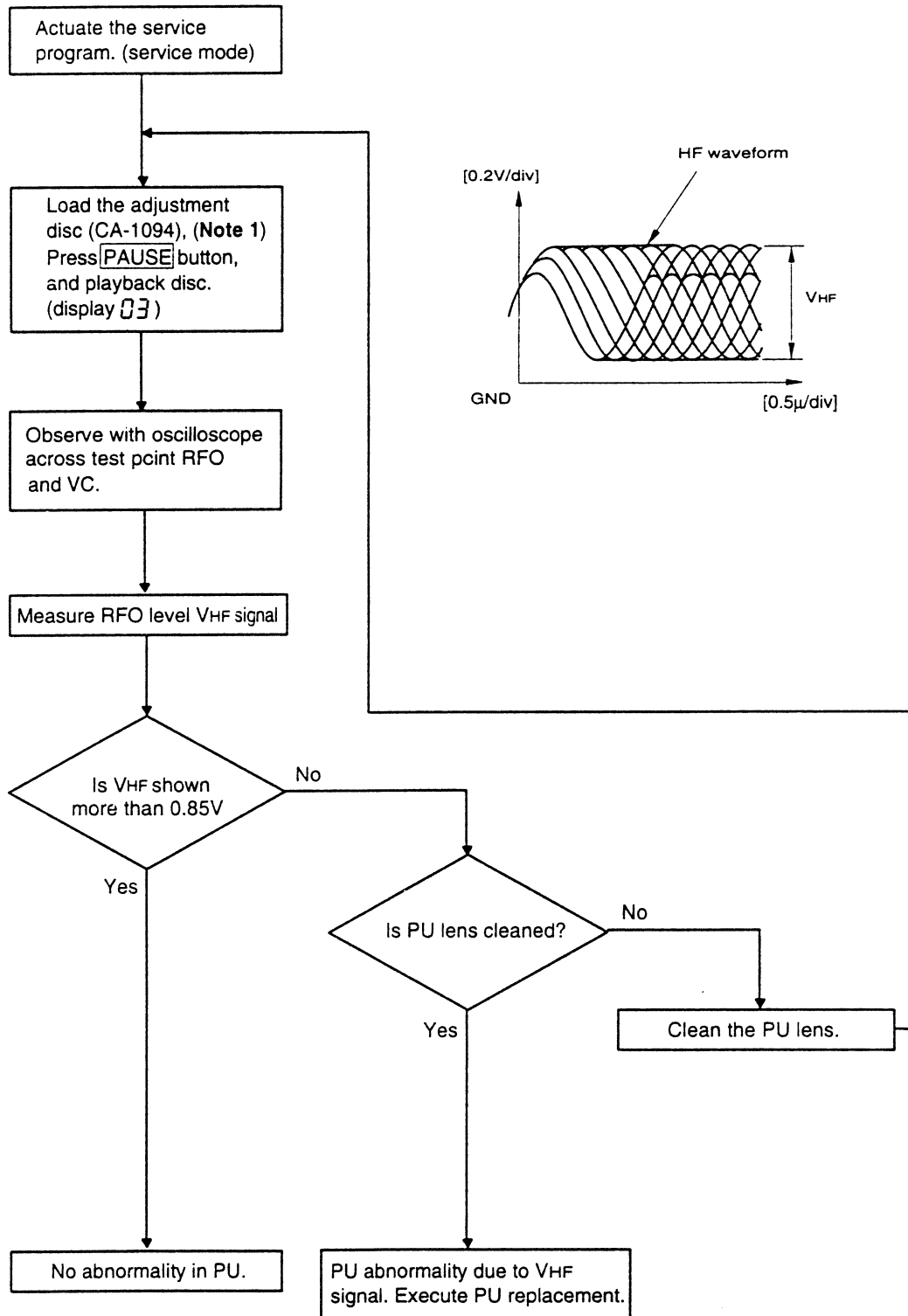

Note 1: Adjustment disc (CO-76143) VHF = 0.85 V.

SEMICONDUCTORS

● IC's
BA6297AFP

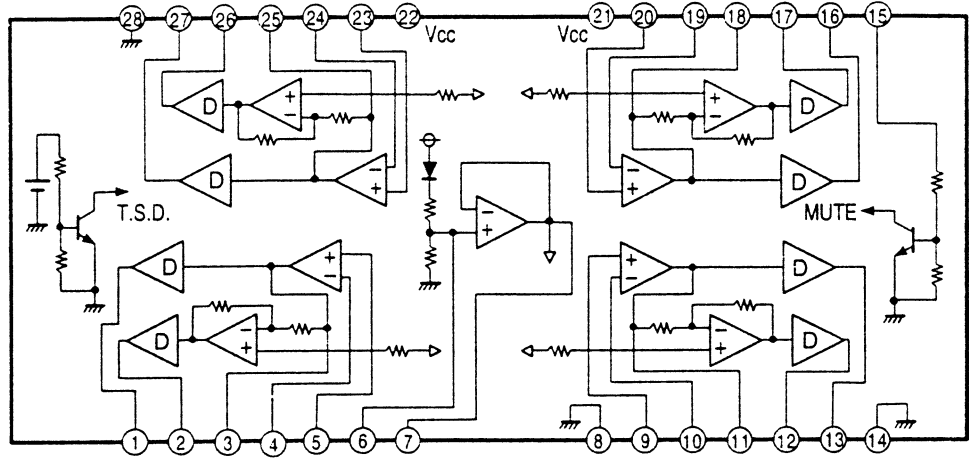
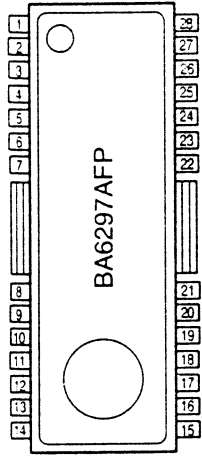

T.S.D: thermal short down
D: driver buffer

BA6297AFP Terminal Function

Pin No.	Symbol	I/O	Function
1		O	CH1 output terminal (+).
2		O	CH1 output terminal (-).
3		O	CH1 Pre-Amplifier output terminal.
4		I	CH1 Pre-Amplifier negative input terminal.
5		I	CH1 Pre-Amplifier positive input terminal.
6			Internal Vref-Amplifier resistor bias terminal.
7		O	Internal Vref-Amplifier output terminal.
8	GND		Vref-Amplifier and constant current ground.
9		I	CH2 Pre-Amplifier positive input terminal.
10		I	CH2 Pre-Amplifier negative input terminal.
11		O	CH2 Pre-Amplifier output terminal.
12		O	CH2 output terminal (-).
13		O	CH2 output terminal (+).
14	GND		CH2 and CH3 driver ground.
15		I	Driver mute control terminal.
16		O	CH3 output terminal (+).
17		O	CH3 output terminal (-).
18		O	CH3 Pre-Amplifier output terminal.
19		I	CH3 Pre-Amplifier negative input terminal.
20		I	CH3 Pre-Amplifier positive input terminal.
21	Vcc		CH2 and CH3 drive power supply.
22	Vcc		CH1 and CH4 drive power supply.
23		I	CH4 Pre-Amplifier positive input terminal.
24		I	CH4 Pre-Amplifier negative input terminal.
25		O	CH4 Pre-Amplifier output terminal.
26		O	CH4 output terminal (-).
27		O	CH4 output terminal (+).
28	GND		CH1 and CH4 driver ground.

Note: Each driver output polarity is reference to Pre-Amplifier output terminal polarity (+).

CXD2515Q

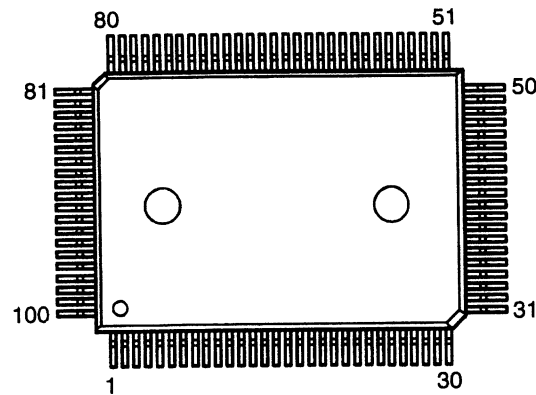

CXD2515Q Terminal Function

Pin No.	Symbol	I/O	Function
1	SRON	O	Sled drive output signal.
2	SRDR	O	Sled drive output signal.
3	SFON	O	Sled drive output signal.
4	TFDR	O	Tracking drive output signal.
5	TRON	O	Tracking drive output signal.
6	TRDR	O	Tracking drive output signal.
7	TFON	O	Tracking drive output signal.
8	FFDR	O	Focus drive output signal.
9	FRON	O	Focus drive output signal.
10	FRDR	O	Focus drive output signal.
11	FFON	O	Focus drive output signal.
12	VCOO	O	Osc. circuit output for analog EFM PLL.
13	VCOI	I	Osc. circuit output for analog EFM PLL.
14	TEST	I	Test terminal, normally GND.
15	DVss	—	Digital ground.
16	TES2	I	Test terminal, normally GND.
17	TES3	I	Test terminal, normally GND.
18	PDO	O	Charge pump output for analog EFM PLL.
19	VPCO	O	PLL charge pump output for variable pitch.
20	VCKI	I	Clock input from external VCO for variable pitch.
21	AVD2	—	Analog power supply.
22	IGEN	I	Power supply terminal for OP amplifier.
23	AVS2	—	Analog ground.
24	ADII	I	A/D converter input terminal.
25	ADIO	O	OP amplifier output terminal.
26	RFDC	I	RF signal input.
27	TE	I	Tracking error signal input.
28	SE	I	Sled error signal input.
29	FE	I	Focus error signal input.
30	VC	I	Middle point voltage input terminal.
31	FILO	O	Filter output for master PLL.
32	FILI	I	Filter input for master PLL.
33	PCO	O	Charge pump output for master PLL.
34	CLTV	I	VCO control voltage input for master.
35	AVS1	—	Analog ground.
36	RFAC	I	EFM signal input.
37	BIAS	I	Asymmetry circuit constant current output.
38	ASY1	I	Asymmetry comparator voltage input.
39	ASY0	O	EFM full swing output.
40	AVDI	—	Analog power supply.

Pin No.	Symbol	I/O	Function
41	DVDD	—	Digital power supply.
42	ASYE	I	Asymmetry circuit ON/OFF.
43	PSSL	I	Mode shift input of audio data output.
44	WDCK	O	48 bit slot D/A interface. word clock.
45	LRCK	O	48 bit slot D/A interface. LR clock.
46	DATA	O	DA16 output at PSSL=1, 48 bit slot serial data at PSSL=0.
47	BCLK	O	DA15 output at PSSL=1, 48 bit slot bit clock at PSSL=0.
48	64DATA	O	DA14 output at PSSL=1, 64 bit slot serial data at PSSL=0.
49	64BCLK	O	DA13 output at PSSL=1, 64 bit slot bit clock at PSSL=0.
50	64LRCK	O	DA12 output at PSSL=1, 64 bit slot LR clock at PSSL=0.
51	GTOP	O	DA11 output at PSSL=1, GTOP output at PSSL=0.
52	XUGF	O	DA10 output at PSSL=1, XUGF output at PSSL=0.
53	XPLCK	O	DA09 output at PSSL=1, XPLCK output at PSSL=0.
54	GFS	O	DA08 output at PSSL=1, GFS output at PSSL=0.
55	RFCK	O	DA07 output at PSSL=1, RFCK output at PSSL=0.
56	C2PO	O	DA06 output at PSSL=1, C2PO output at PSSL=0.
57	XRAOF	O	DA05 output at PSSL=1, XRAOF output at PSSL=0.
58	MNT3	O	DA04 output at PSSL=1, MNT3 output at PSSL=0.
59	MNT2	O	DA03 output at PSSL=1, MNT2 output at PSSL=0.
60	MNT1	O	DA02 output at PSSL=1, MNT1 output at PSSL=0.
61	MNT0	O	DA01 output at PSSL=1, MNT0 output at PSSL=0.
62	XTAI	I	X'tal Osc, circuit input.
63	XTAO	O	X'tal Osc, circuit output.
64	XTSL	I	X'tal select input terminal.
65	DVss	—	Digital ground.
66	FSTI	I	2/3 cycle input of Pin 62, 63.
67	FSTO	O	2/3 cycle output of Pin 62, 63.
68	C4M	O	4.2336 MHz output.
69	C16M	O	16.9344 MHz output.
70	MD2	I	Digital-Out ON/OFF control terminal.
71	DOUT	O	Digital-Out output terminal.
72	EMPH	O	Playback disc emphasis mode output.
73	WFCK	O	WFCK output.
74	SCOR	O	Sub code sync output terminal.
75	SBSO	O	Sub P-W serial output.
76	EXCK	I	Clock input for SBSO read out.
77	SUBQ	O	Sub Q 80 bit output.
78	SQCK	I	Clock input for SQSO read out.
79	MUTE	I	Mute shift terminal.
80	SENS	O	SENS output.
81	XRST	I	System reset.
82	DIRC	I	Using at 1 track jump.
83	SCLK	I	Clock for SENS serial data read out.
84	DFSW	I	DFCT shift terminal.
85	ATSK	I	Anti-shock terminal.
86	DATA	I	Serial data input from CPU.
87	XLAT	I	Latch input from CPU.
88	CLOK	I	Serial data transfer clock input from CPU.

IC HD643372FD01F

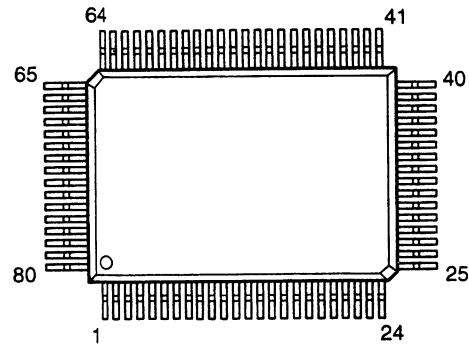

HD643372FD01F Terminal Function

Pin No.	Terminal Name	Symbol	I/O	Det	Res	Ext	Ini	Op	Function
1	P04/AN4	K3	I	Lv	Z	Pd	—	—	Key matrix input.
2	P05/AN5	K2	I	Lv	Z	Pd	—	—	Key matrix input.
3	P06/AN6	K1	I	Lv	Z	Pd	—	—	Key matrix input.
4	P07/AN7	NC	I	—	Z	—	—	—	GND
5	AVss	AVss	I	—	—	—	—	—	GND
6	TEST	TEST	I	—	—	—	—	—	Connect to GND.
7	X2	—	O	—	Z	—	—	—	Open
8	X1	—	I	—	—	—	—	—	Connect to Voc.
9	Vss	Vss	I	—	—	—	—	—	GND
10	OSC1	OSC1	I	—	—	—	—	—	Connect to ceramic oscillator.
11	OSC2	OSC2	O	—	—	—	—	—	Connect to ceramic oscillator.
12	RES	RESET	I	Lv	—	—	—	—	System reset signal input.
13	P10/IRQ0	REMOTE	I	Ed	Z	—	—	—	Interruption signal from remote control.
14	P11/IRQ1	SENS	I	Lv,Ed	Z	—	—	—	Sense input (CXD2515).
15	P12/IRQ1	SCOR	I	Ed	Z	—	—	—	Interruption input from SUB CODE.
16	P13/IRQ3	SIN. OUT	O	—	Z	—	—	—	Communication output for SINCRO REC.
17	P14/IRQ4	SIN. IN	I	Ed	Z	—	—	—	Communication input for SINCRO REC.
18	P15/IRQ5	NC	O	—	—	—	—	—	
19	P16/EVENT	NC	I	—	Z	—	—	—	GND
20	P33/FS27	NC	O	Ed	Z	—	L	—	Open
21	P32/FS26	NC	O	—	Z	—	L	—	Open
22	P31/FS25	NC	O	—	Z	—	L	—	Open
23	P30/FS24	NC	O	—	Z	—	L	—	Open
24	P47/FS23	NC	O	—	Z	—	L	—	Open
25	P46/FS22	NC	O	—	Z	—	L	—	Open
26	P45/FS21	NC	O	—	Z	—	L	—	Open
27	P44/FS20	NC	O	—	Z	—	L	—	Open
28	P43/FS19	P(A)	O	—	Z	Pdisp	L	—	Segment output for VFD.
29	P42/FS18	P(B)	O	—	Z	Pdisp	L	—	Segment output for VFD.
30	P41/FS17	P(C)	O	—	Z	Pdisp	L	—	Segment output for VFD.
31	P40/FS16	P(D)	O	—	Z	Pdisp	L	—	Segment output for VFD.
32	P50/FS15	P(E)	O	—	Z	Pdisp	L	—	Segment output for VFD.
33	P51/FS14	P(F)	O	—	Z	Pdisp	L	—	Segment output for VFD.
34	P52/FS13	P(G)	O	—	Z	Pdisp	L	—	Segment output for VFD.
35	P53/FS12	P(H)	O	—	Z	Pdisp	L	—	Segment output for VFD.

Pin No.	Terminal Name	Symbol	I/O	Det	Res	Ext	Ini	Op	Function
36	P54/FS11	P(I)	O	—	Z	Pdisp	L	—	Segment output for VFD.
37	P55/FS10	P(J)	O	—	Z	Pdisp	L	—	Segment output for VFD.
38	P56/FS9	P(K)	O	—	Z	Pdisp	L	—	Segment output for VFD.
39	P57/FS8	P(L)	O	—	Z	Pdisp	L	—	Segment output for VFD.
40	P17/Vdisp	Vdisp	I	—	Z	—	—	—	VEE for VFD
41	P60/FD0	G8	O	—	Z	Pdisp	L	—	Gird output for VFD.
42	P61/FD1	G7	O	—	Z	Pdisp	L	—	Gird output for VFD.
43	P62/FD2	G6	O	—	Z	Pdisp	L	—	Gird output for VFD.
44	P63/FD3	G5	O	—	Z	Pdisp	L	—	Gird output for VFD.
45	P64/FD4	G4	O	—	Z	Pdisp	L	—	Gird output for VFD.
46	P65/FD5	G3	O	—	Z	Pdisp	L	—	Gird output for VFD.
47	P66/FD6	G2	O	—	Z	Pdisp	L	—	Gird output for VFD.
48	P67/FD7	G1	O	—	Z	Pdisp	L	—	Gird output for VFD.
49	P70/FD8	NC	O	—	Z	—	L	—	Open
50	P71/FD9	NC	O	—	Z	—	L	—	Open
51	P72/FD10	NC	O	—	Z	—	L	—	Open
52	P73/FD11	NC	O	—	Z	—	L	—	Open
53	P74/FD12	NC	O	—	Z	—	L	—	Open
54	P75/FD13	NC	O	—	Z	—	L	—	Open
55	P76/FD14	NC	O	—	Z	—	L	—	Open
56	P77/FD15	NC	O	—	Z	—	L	—	Open
57	Vcc	Vcc	I	—	—	—	—	—	Power supply.
58	P80	A. MUTE	O	—	Z	Pu	H	—	Analog mute output.
59	P81	MDT	O	—	Z	—	L	—	SM5841 control data output.
60	P82	MCK	O	—	Z	—	L	—	SM5841 control bit clock output.
61	P83	MLE	O	—	Z	—	L	—	SM5841 control latch output.
62	P84	OPEN	O	—	Z	—	L	—	CD MACHA. Loader drive signal.
63	P85	CLOSEE	O	—	Z	—	L	—	CD MACHA. Loader drive signal.
64	P86	D.MUTE	O	—	Z	Pu	H	—	Digital mute signal.
65	P87	LD ON	O	—	Z	—	L	—	Laser control signal.
66	P90/PWM	SCLK	O	—	Z	—	H	—	Servo setting value read clock output (CXD2515).
67	P91/SCK1	CLK	O	—	Z	—	H	—	Control clock output (CXD2515).
68	P92/SI1	XLT	O	—	Z	—	H	—	Control Latch output (CXD2515).
69	P93/S01	DATA	O	—	Z	—	H	—	Control data output (CXD2515).
70	P94/SCK2	SQCK	I	—	Z	—	—	—	SUB CODE clock input (CXD2515)
71	P95/SI2	SUBQ	I	—	Z	—	—	—	SUB CODE Q data input.
72	P96/S02	NC	O	—	Z	—	—	—	Open
73	P97	NC	O	—	Z	—	—	—	Open
74	PA0	NC	O	—	Z	—	—	—	Open
75	PA1	NC	O	—	Z	—	—	—	Open
76	AVCC	AVcc	I	—	—	—	—	—	Power supply.
77	PO0/AN0	OUT SW	I	Lv	Z	—	—	—	Loader open signal (L: open).
78	P01/AN1	IN SW	I	Lv	Z	—	—	—	Loader close signal (L: close).
79	P02/AN2	GFS	I	Lv	Z	—	—	—	GFS input (CXD2515).
80	P03/AN3	FOK	I	Lv	Z	—	—	—	FOK input (CXD2515).

Note:

- I/O: Port input/output direction (I: input, O: output).
- Det: Input level detection mode (Lv: level detection, Ed: edge detection).
- Res: Port state at reset (Z: high impedance).
- Ext: External addition (Pu: external pull up, Pd: external pull down, but mask option is existing.)
- Ini: Initial output value.
- Op: Mask option.

● IC's

BA15218
μPC4570C

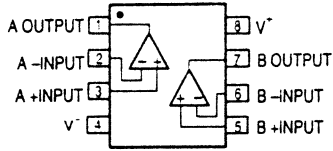
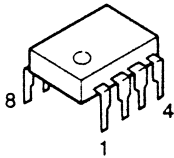

SM5841BP

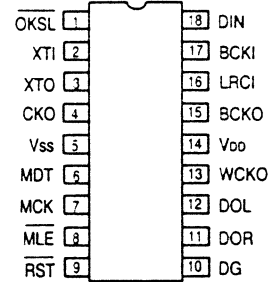
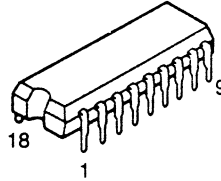

M5290
PCM61P-L

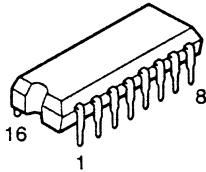

M5290P

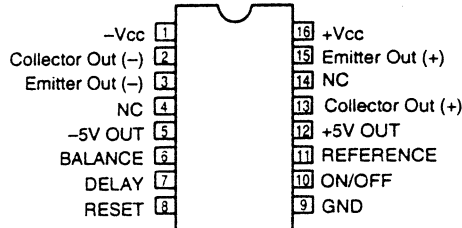

PCM61P-L

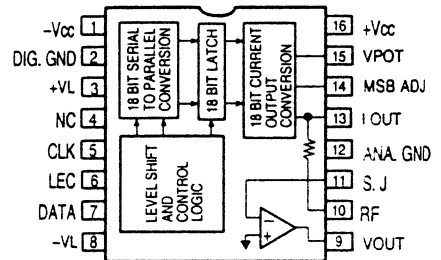

TC74HCU04AP

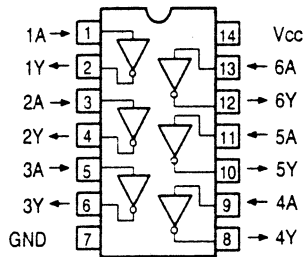
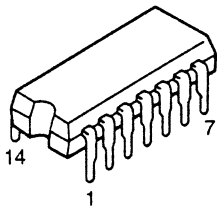

● IC PROTECTOR

ICP-N15T

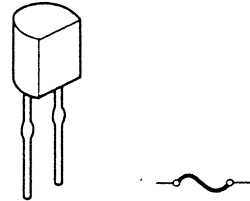

SBX1610-52 (Remoto Control Receiver)

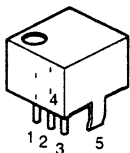

1. Vcc
2. Output
3. GND
4. Case Fin
5. Case Fin

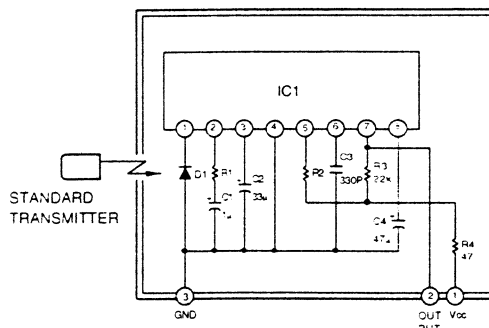

- IC1 : CX20106A Chip
- D1 : PIN Photodiode Chip
- C1, C2, C4 : Aluminum Electrolytic Capacitor
- C3 : SL Characteristic ±5%
- R1 : Gain control resistor
- R2 : for control resistor (Using ±1%)
- R (Other than above items) : ±5%

● TRANSISTORS

2SD1762
2SB1185

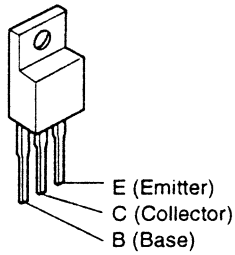

2SD2144

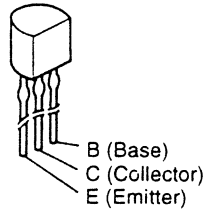

2SA934 (Q)
2SC2060 (Q)

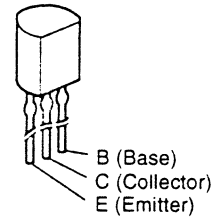

2SA933S(S)
DTA124XS (22K-47K)
DTC114ES (10K-10K)

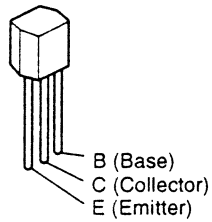

DTA124XS (22K-47K)

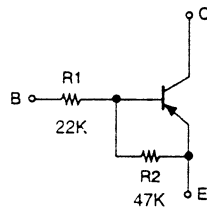

DTC114ES (10K-10K)

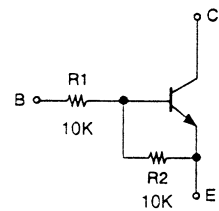

● DIODES

MTZJ6.2A
MTZJ6.8A
MTZJ8.2A
MTZJ24A

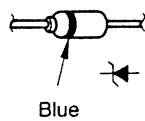

1SR35-200A

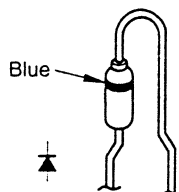

1SS252

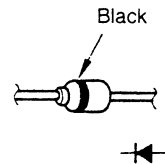

NOTE FOR PARTS LIST

- Part indicated with the mark "◎" are not always in stock and possibly to take a long period of time for supplying, or in some case supplying of part may be refused.
- When ordering of part, clearly indicate "1" and "I" (i) to avoid mis-supplying.
- Ordering part without stating its part number can not be supplied.
- Part indicated with the mark "★" is not illustrated in the exploded view.
- Not including Carbon Film ±5%, 1/4W Type in the P.W.Board parts list. (Refer to the Schematic Diagram for those parts.)

WARNING:

Parts marked with this symbol  have critical characteristics.
Use ONLY replacement parts recommended by the manufacturer.

● **Resistors**

Ex.: RN 14K 2E 182 G FR
 Type Shape and performance Power Resistance Allowable error Others

RD : Carbon	2B : 1/8W	F : ±1%	P : Pulse-resistant type
RC : Composition	2E : 1/4W	G : ±2%	NL : Low noise type
RS : Metal oxide film	2H : 1/2W	J : ±5%	NB : Non-burning type
RW : Winding	3A : 1W	K : ±10%	FR : Fuse-resistor
RN : Metal film	3D : 2W	M : ±20%	F : Lead wire forming
RK : Metal mixture	3F : 3W		
	3H : 5W		

• **Resistance**

1 8 2 ⇒ 1800 ohm = 1.8 kohm
 Indicates number of zeros after effective number.
 2-digit effective number.

• Units: ohm

1 R 2 ⇒ 1.2 ohm
 1-digit effective number.
 2-digit effective number, decimal point indicated by R.

• Units: ohm

● **Capacitors**

Ex.: CE 04W 1H 2R2 M BP
 Type Shape and performance Dielectric strength Capacity Allowable error Others

CE : Aluminum foil electrolytic	OJ : 6.3V	F : ±1%	HS : High stability type
CA : Aluminum solid electrolytic	1A : 10V	G : ±2%	BP : Non-polar type
CS : Tantalum electrolytic	1C : 16V	J : ±5%	HR : Ripple-resistant type
CQ : Film	1E : 25V	K : ±10%	DL : For charge and discharge
CK : Ceramic	1V : 35V	M : ±20%	HF : For assuring high frequency
CC : Ceramic	1H : 50V	Z : +80%	U : UL part
CP : Oil	2A : 100V	-20%	C : CSA part
CM : Mica	2B : 125V	P : +100%	W : UL-CSA type
CF : Metallized	2C : 160V	-0%	F : Lead wire forming
CH : Metallized	2D : 200V	C : ±0.25pF	
	2E : 250V	D : ±0.5pF	
	2H : 500V	= : Others	
	2J : 630V		

• **Capacity (electrolyte only)**

2 2 2 ⇒ 2200µF
 Indicates number of zeros after effective number.
 2-digit effective number.

• Units: µF.

2 R 2 ⇒ 2.2µF
 1-digit effective number.
 2-digit effective number, decimal point indicated by R.

• Units: µF.

• **Capacity (except electrolyte)**

2 2 2 ⇒ 2200pF = 0.0022µF
 (More than 2) - Indicates number of zeros after effective number.
 2-digit effective number.

• Units: µF.

2 2 1 ⇒ 220pF
 (0 or 1) - Indicates number of zeros after effective number.
 2-digit effective number.

• Units: pF.

• When the dielectric strength is indicated in AC, "AC" is included after the dielectric strength value.

PARTS LIST OF PRINTED WIRING BOARD

KU-9330 CD P.W.B. UNIT ASS'Y

Ref. No.	Part No.	Part Name	Remarks	Ref. No.	Part No.	Part Name	Remarks
SEMICONDUCTORS GROUP				CAPACITORS GROUP			
IC201	262 2174 008	IC HD643724D01F		C201~204	253 1181 904	Ceramic 0.01 μ F/50V	CK45F1H103Z
IC202	262 1265 002	IC TC74HCU04AP		C205	254 4254 954	Electrolytic 220 μ F/16V	CE04W1C221M
IC203	263 0565 007	IC BA15218		C206	254 4254 909	Electrolytic 10 μ F/16V	CE04W1C100M
IC301	262 1761 001	IC SM5841BP		C207	253 1181 904	Ceramic 0.01 μ F/50V	CK45F1H103Z
IC302,303	262 1409 004	IC :PCM61P-L		C208	254 4254 925	Electrolytic 33 μ F/16V	CE04W1C330M
IC501	263 0693 005	IC M5290P		C209,210	253 9039 906	Ceramic 0.1 μ F/25V	CK45=1E104Z
IC502,503	268 0073 905	IC ICP-N15		C213	253 9039 906	Ceramic 0.1 μ F/25V	CK45=1E104Z
IC701	262 0864 006	IC μ PC4570C		C215	253 9039 906	Ceramic 0.1 μ F/25V	CK45=1E104Z
TR201	274 0120 002	Transistor 2SD1762(E/F)		C301	253 1180 921	Ceramic 1000 pF/50V	CK45B1H102K
TR202	273 0195 908	Transistor 2SC2060(Q)		C302,303	253 4536 909	Ceramic 10 pF/50V	CC45SL1H100D
TR203	271 0271 907	Transistor 2SA934(Q)		C304~307	253 9039 906	Ceramic 0.1 μ F/25V	CK45=1E104Z
TR204,205	269 0020 906	Transistor DTC114ES	Built in resistor	C308,309	254 4254 954	Electrolytic 220 μ F/16V	CE04W1C221M
TR301,302	274 0160 907	Transistor 2SD2144STPU		C310,311	253 1180 905	Ceramic 680 pF/50V	CK45B1H681K
TR501	274 0120 002	Transistor 2SD1762(E/F)		C312,313	253 1121 906	Ceramic 5600 pF/50V	CK45B1H562K
TR502	272 0083 004	Transistor 2SB1185(E/F)		C314,315	254 4254 941	Electrolytic 100 μ F/16V	CE04W1C101M
TR503	271 0271 907	Transistor 2SA934(Q)		C316,317	253 1180 921	Ceramic 1000 pF/50V	CK45B1H102K
TR600,601	274 0160 907	Transistor 2SD2144STPU		C501	254 4254 792	Electrolytic 2200 μ F/16V	CE04W1C222MC
TR701	271 0192 905	Transistor 2SA933S(S)		C502	254 4255 717	Electrolytic 4700 μ F/16V	CE04W1C472MC
TR702	269 0014 909	Transistor DTA124XS	Built in resistor	C505	254 4260 948	Electrolytic 1 μ F/50V	CE04W1H010M
TR703	269 0020 906	Transistor DTC114ES	Built in resistor	C506	254 4260 964	Electrolytic 3.3 μ F/50V	CE04W1H3R3M
D501~506	276 0553 905	Diode 1SR35-200A		C507	254 4262 946	Electrolytic 47 μ F/63V	CE04W1J47DM
D601~608	276 0616 907	Diode 1SS252		C508	254 4261 921	Electrolytic 100 μ F/50V	CE04W1H101M
D701	276 0616 907	Diode 1SS252		C509,510	254 4258 934	Electrolytic 33 μ F/35V	CE04W1V330M
ZD201	276 0644 924	Zener diode MTZ8.2A		C600,601	253 1181 904	Ceramic 0.01 μ F/50V	CK45F1H103Z
ZD202,203	276 0637 902	Zener diode MTZ6.2A		C701	254 4254 954	Electrolytic 220 μ F/16V	CE04W1C221 M
ZD501	276 0644 908	Zener diode MTZ5.8A		C702,703	253 4537 982	Ceramic 56 pF/50V	CC45SL1H560J
ZD502	276 0645 936	Zener diode MTZ24A		C704,705	254 4250 929	Electrolytic 100 μ F/6.3V	CE04W0J101 M
				C708,709	254 4254 941	Electrolytic 100 μ F/16V	CE04W1C101 M
RESISRORS GROUP (not included carbon film \pm5% 1/4W type)				OTHER PARTS			
VR300,301	211 6093 970	Semi fixed resistor 100k ohm	V06BP104	CB202	205 0549 027	29P FFC connector base	
VR601	211 0661 010	Variable 2k ohm	V0920P30FC202	CB500	203 3959 003	2P inlet	
▲ R714, 715	241 2375 981	Carbon 22 ohm 1/4W (Non-burning)	RD14B2E220JNBS	CB504	205 0549 072	23P FFC connector base	
				CB601	205 0343 045	4P connector base(KR-PH)	
				CB602	205 0549 027	29P FFC connector base	
				CN201	203 8424 009	5P connector cord	AMP
				CN601	203 6315 000	:4P KR-DA connector cord	
				CN606	203 0569 027	1P contact Ass'y	
				FL601	393 4110 005	FL tube	FIP8NM6A
				JK201	204 8262 002	1P pin jack	
				JK202	204 8416 007	Mini jack	
				JK301	204 8487 007	2P pin jack	
				JK601	204 8364 007	Head phone jack	
				L201,202	235 0049 900	Beads inductor	
				PT201	231 8063 009	:Pulse trans	
				RM601	499 0150 008	Remoto sensor	SBX1610-52
				SW600	212 1039 000	Power switch	
				▲ T500	233 9682 003	Power transformer	
				XL201	399 0111 909	Resonator	CST4.23MGV040
				XL301	399 0112 005	:Crystal	16.9344MHz
					203 6290 028	:4P DA-DA connector cord	CC604-605

SA4 6494 32A CD MECHANISM P.W.B. UNIT ASS'Y

Ref. No.	Part No.	Part Name	Remarks
SEMICONDUCTORS GROUP			
IC001	262 1879 003	IC CXD2515Q	
IC102	926 0000 100	IC BA297AFP	
RESISRORS GROUP (not included carbon film $\pm 5\%$ 1/4W type)			
R101	247 0010 929	Chip 15k ohm 1/10W	RM73B-153J
R102	247 0012 927	Chip 100k ohm 1/10W	RM73B-104J
R103	247 0010 929	Chip 15k ohm 1/10W	RM73B-153J
R104	247 0011 902	Chip 33k ohm 1/10W	RM73B-333J
R105	247 0012 927	Chip 100k ohm 1/10W	RM73B-104J
R106,107	247 0008 960	Chip 3.3k ohm 1/10W	RM73B-332J
R108	247 0009 985	Chip 10k ohm 1/10W	RM73B-103J
R109	247 0014 967	Chip 1M ohm 1/10W	RM73B-105J
R110	247 0005 905	Chip 100 ohm 1/10W	RM73B-101J
R112	247 0007 945	Chip 1k ohm 1/10W	RM73B-102J
R113,114	247 0010 929	Chip 15k ohm 1/10W	RM73B-153J
R117,118	247 0010 929	Chip 15k ohm 1/10W	RM73B-153J
R121,122	247 0010 929	Chip 15k ohm 1/10W	RM73B-153J
R123	247 0009 985	Chip 10k ohm 1/10W	RM73B-103J
R124	247 0012 927	Chip 100k ohm 1/10W	RM73B-104J
R125-127	247 0007 945	Chip 1k ohm 1/10W	RM73B-102J
R131	247 0006 920	Chip 330 ohm 1/10W	RM73B-331J
R151-156	247 0009 956	Chip 7.5k ohm 1/10W	RM73B-752J
R157	247 0011 986	Chip 68k ohm 1/10W	RM73B-683J
R158	247 0010 916	Chip 13k ohm 1/10W	RM73B-133J
R159	247 0011 902	Chip 33k ohm 1/10W	RM73B-333J
R160	247 0010 961	Chip 22k ohm 1/10W	RM73B-223J
R161	247 0101 980	Chip 4.7 ohm 1/10W	RM73B-4R7J
R162,163	247 0011 986	Chip 68k ohm 1/10W	RM73B-683J
CAPACITORS GROUP			
C101	257 0008 941	Chip(Ceramic) 470 pF/50V	CK73B1H471K
C102	257 0014 935	Chip(Ceramic) 0.1 μ F/25V	CK73F1E104Z
C103	257 0008 941	Chip(Ceramic) 470 pF/50V	CK73B1H471K
C105	S11 3515 521	Chip(Ceramic) 4.7 μ F/16V	
C106	S11 6434 611	Chip(Ceramic) 1 μ F/16V	
C107	S11 6450 511	Chip(Ceramic) 2.2 μ F/16V	
C108	257 0013 907	Chip(Ceramic) 0.047 μ F/50V	CK73F1H473Z
C109	257 0009 908	Chip(Ceramic) 1500 pF/50V	CK73B1H152K
C110	S11 6317 700	Chip(Ceramic) 4700 pF/50V	
C111	257 0004 961	Chip(Ceramic) 100 pF/50V	CC73SL1H101J
C112,113	257 0014 935	Chip(Ceramic) 0.1 μ F/25V	CK73F1E104K
C123	257 0012 966	Chip(Ceramic) 0.01 μ F/50V	CK73F1H103Z
C124	S11 6400 511	Chip(Ceramic) 0.47 μ F/25V	
C151,152	257 0008 967	Chip(Ceramic) 680 pF/50V	CK73B1H681K
C153	257 0014 935	Chip(Ceramic) 0.1 μ F/25V	CK73F1E104K
C154	257 0015 905	Chip(Ceramic) 0.33 μ F/25V	CK73F1E104K
C155,156	257 0008 967	Chip(Ceramic) 680 pF/50V	CK73B1H681K
C157,158	257 0012 982	Chip(Ceramic) 0.022 μ F/50V	CK73F1H223Z
C159	S11 6302 300	Chip(Ceramic) 0.015 μ F/50V	CK73B1H153K
C160	257 0012 953	Chip(Ceramic) 6800 pF/50V	CK73F1H682Z
C161	257 0014 935	Chip(Ceramic) 0.1 μ F/25V	CK73F1E104Z
OTHER PARTS			
CN101	S15 6886 511	23P connector base	
CN102	S15 6879 511	12P connector base	
S101	S15 7208 511	Leaf switch(LIMIT)	

S16 4572 111 LOADING P.W.B. UNIT ASS'Y

Ref No.	Part No.	Part Name	Remarks
OTHER PARTS			
S151	S15 7208 511	Leaf switch(LIMIT)	
S152	S15 7208 511	Leaf switch(LIMIT)	
CN151	S15 6894 311	5P connector base(L Type)	

PRINTED WIRING BOARD

1 2 3 4

CD MECHANISM UNIT SA4 6494 32A P.W.B. ASS'Y

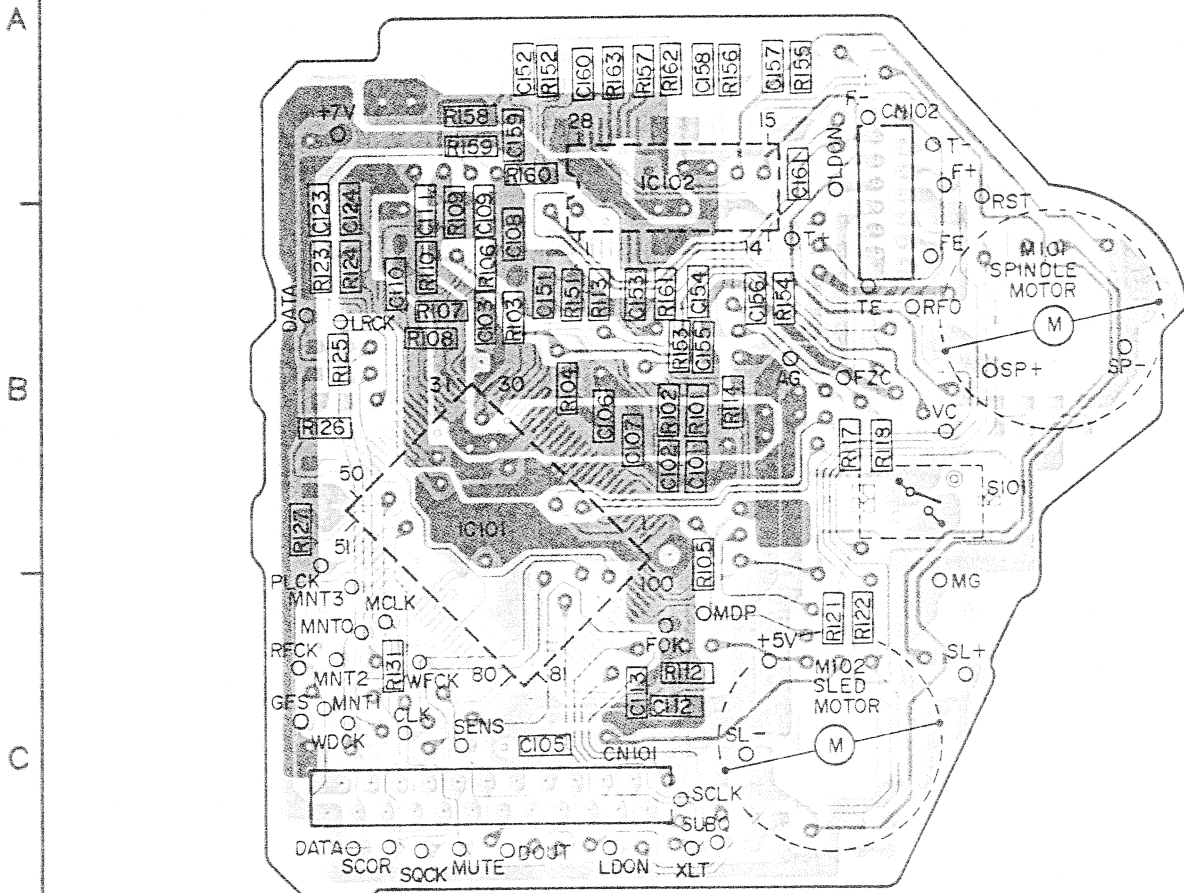

S16 4572 111 LOADING P.W.B. ASS'Y

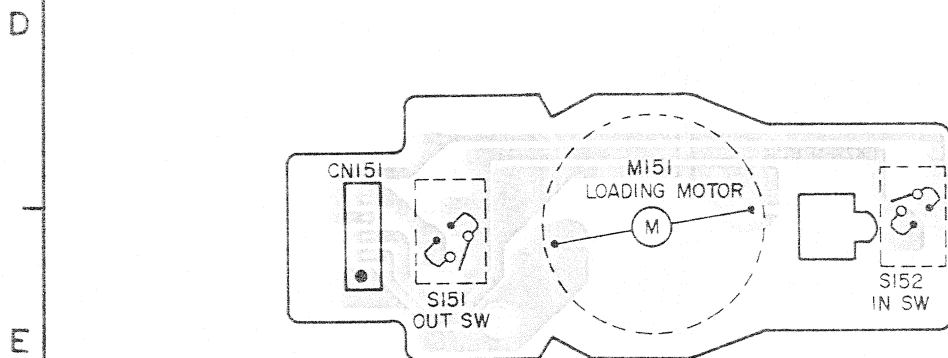

1 2 3 4 5 6 7 8

KU-9330 CD P.W.B. UNIT ASS'Y

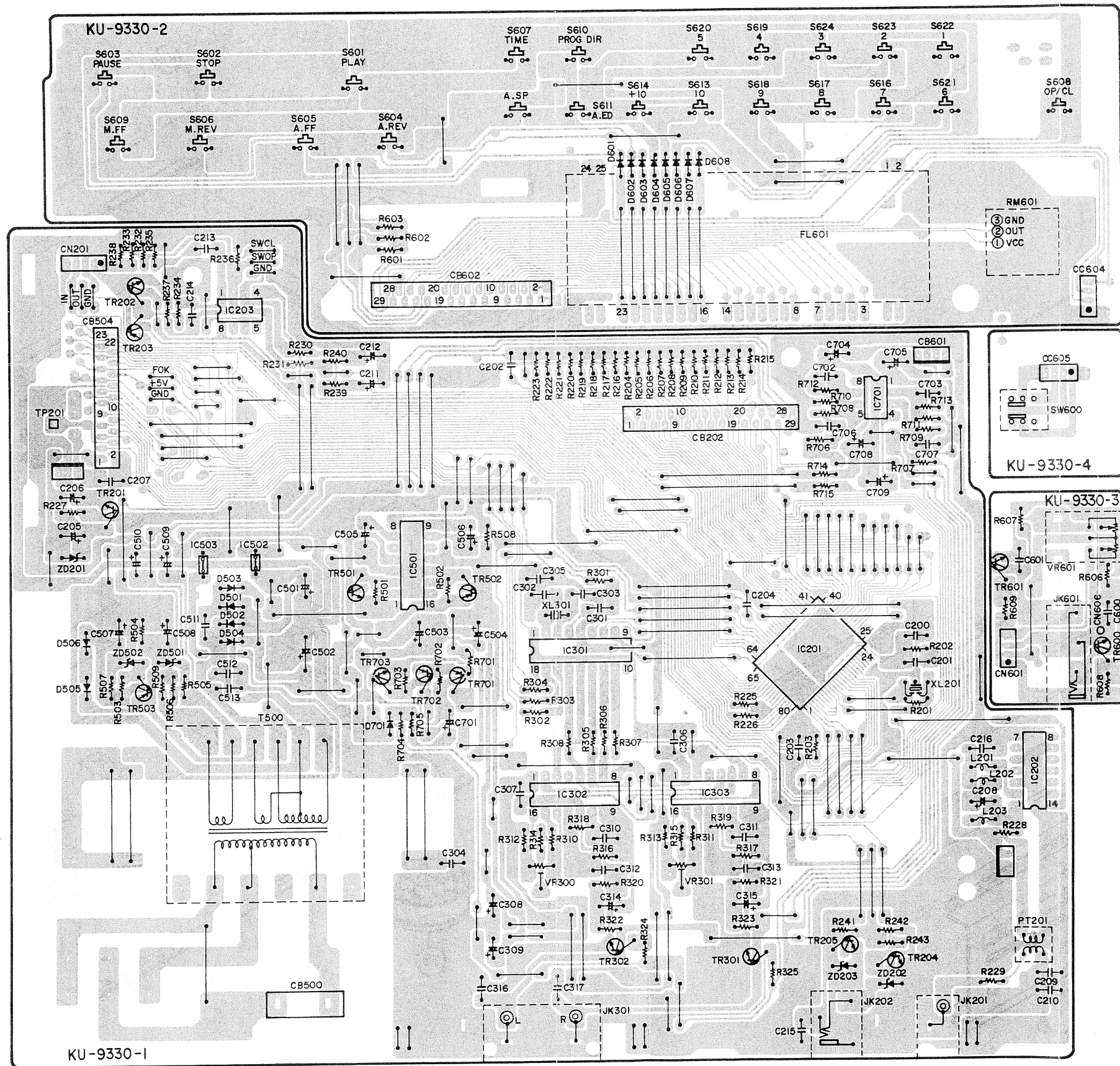

A
B
C
D
E

EXPLODED VIEW OF CHASSIS AND CABINET

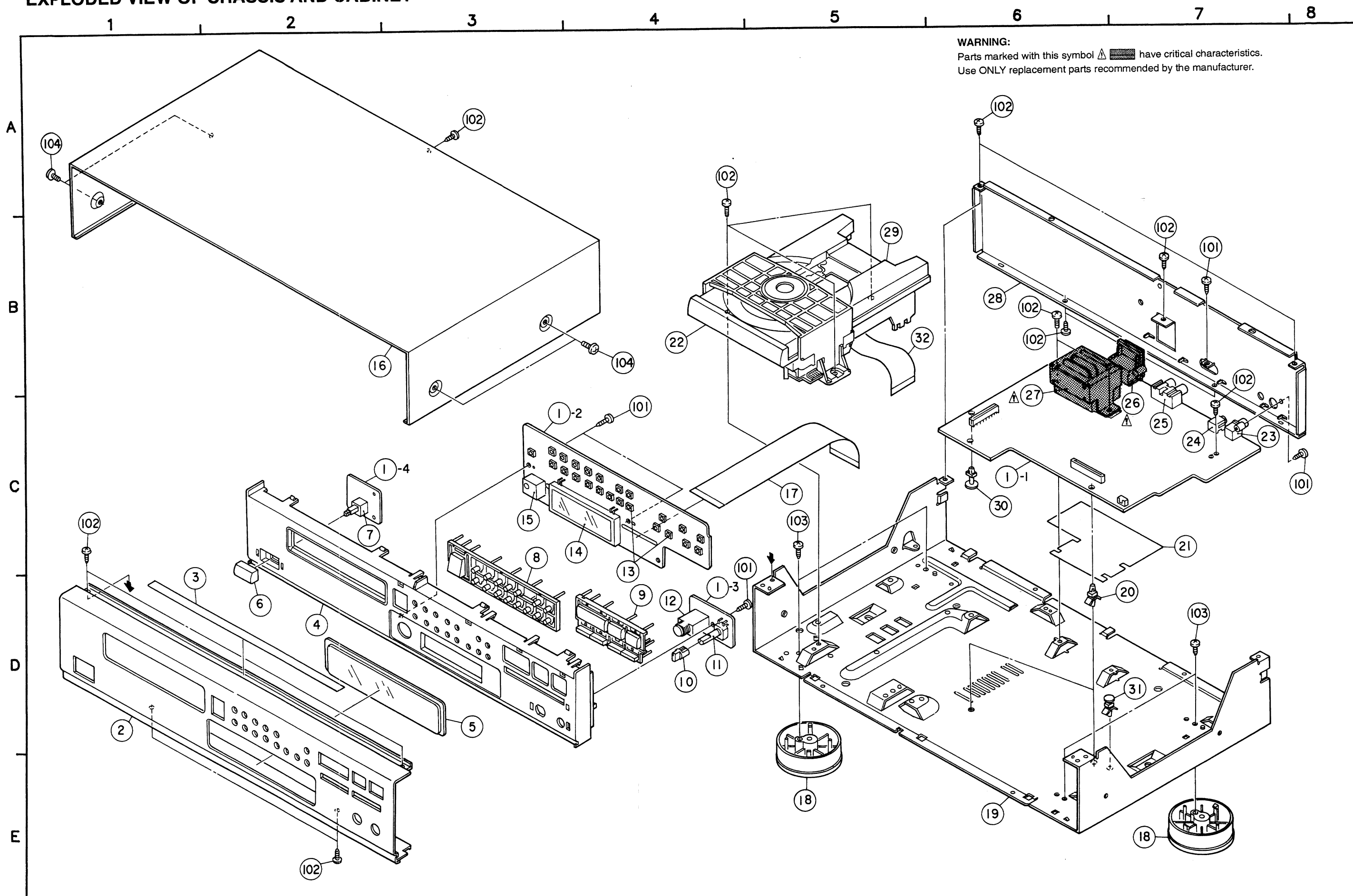

EXPLODED VIEW OF CD MECHANISM UNIT

MD UNIT

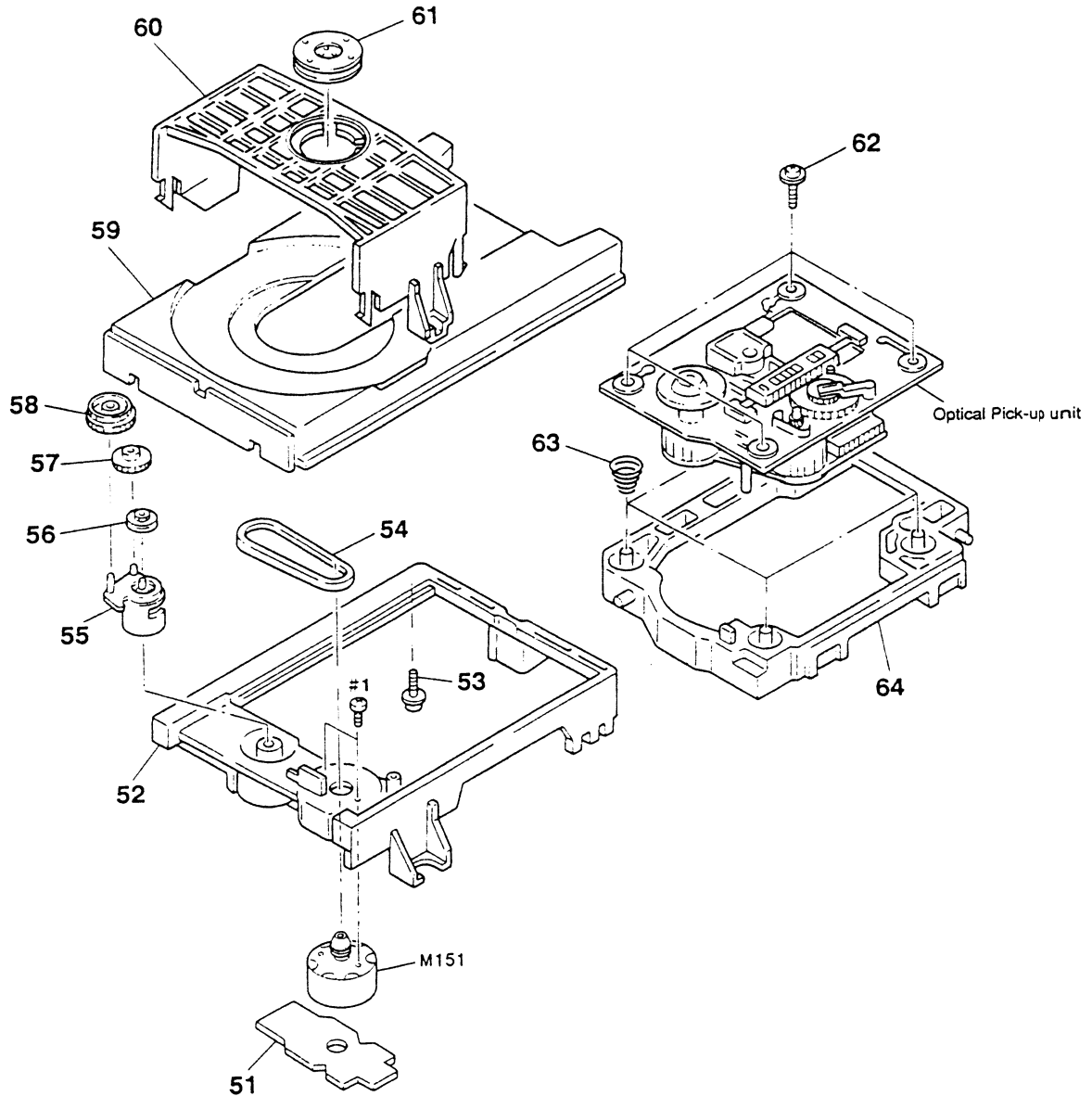

PARTS LIST OF CD MECHANISM UNIT

Ref. No.	Part No.	Part Name	Remarks	Ref. No.	Part No.	Part Name	Remarks
51	S16 4572 111	Loading P.W.B. Ass'y	See Page 27, 28	59	S49 3311 201	Disk Table	
52	S49 3311 101	Chassis (MD)		60	S49 3311 001	Holder (MG)	
53	S49 1758 321	Yoke Bracket		61	S14 5253 811	Magnet	
54	S49 2764 901	Belt		62	S49 3313 401	Screw	
55	S49 3310 901	Cam		63	S49 4850 301	Spring (BU)	
56	S49 2765 101	Pulley (S)		64	S49 3312 901	Holder (BU)	
57	S49 2762 801	Gear (C)		M151	SA4 6043 63A	Motor (L) Ass'y	
58	S49 3310 701	Gear (PL)		#1	471 3201 024	Screw 2.6×4	

PARTS LIST OF EXPLODED VIEW

* Gold model= Except to U.K.

Ref. No.	Part No.	Part Name	Remarks	Q'ty	Ref. No.	Part No.	Part Name	Remarks	Q'ty
● — 1	KU- 9330	CD P.W.B. unit Ass'y		1	PACKING & ACCESSORIES				
- 1-1	—	Main P.W.B. unit			●	505 0131 050	Cabinet cover		1
- 1-2	—	Display P.W.B. unit			●	505 0283 018	:Envelope		1
- 1-3	—	H/P jack P.W.B. unit			●	511 9424 006	:Operating instructions		1
- 1-4	—	Power sw. P.W.B. unit				203 2310 009	2P pin cord		1
						499 0243 106	:Remoto control unit	RC-241	1
● 2	144 9229 302	Front panel	Black model	1	▲	206 2108 003	:AC connector with plug	Europe model	1
● 2	144 9229 315	Front panel	Gold model	1	▲	206 2113 001	:AC cord with connector	U.K model	1
● 3	122 0187 100	Top cover spacer		1	●	504 0125 005	:Stylen paper	U.K model only	1
● 4	146 9336 204	Inner panel Ass'y with window	Black model	1	●	503 9223 002	:Cushion	Europe model	2
● 4	146 9336 217	Inner panel Ass'y with window	Gold model	1	●	503 1173 008	:Cushion	U.K model	2
(5)	(143 9186 109	Window)		1	●	501 1803 039	:Carton case	Europe model	1
6	113 1689 001	Power sw. button	Black model	1	●	501 1817 041	:Carton case	U.K model	1
6	113 1689 014	Power sw. button	Gold model	1					
7	212 1039 000	Power switch	SW600	1					
8	113 9321 109	Program button	Black model	1					
8	113 9321 112	Program button	Gold model	1					
9	113 1687 207	Function butonn	Black model	1					
9	113 1687 210	Function butonn	Gold model	1					
10	112 0645 111	Head phone knob	Black model	1					
10	112 0645 124	Head phone knob	Gold model	1					
11	211 0661 010	Variable resistor	VR601	1					
12	204 8364 007	Head phone jack	JK601	1					
13	212 5604 910	Tact switch		23					
14	393 4110 005	FL tube (FIP8NM6A)	FL601	1					
15	499 0150 008	Remoto sensor	RM601	1					
● 16	102 0424 005	:Top cover	Black model	1					
● 16	102 0424 018	:Top cover	Gold model	1					
● 17	009 0109 021	:29P FFC cable	L=170	1					
● 18	104 0230 101	:Foot Ass'y		4					
● 19	411 1323 216	Chassis		1					
20	449 0033 049	Locking card spacer		1					
21	461 0878 000	PVC sheet		1					
● 22	146 1552 109	Loader panel	Black model	1					
● 22	146 1552 112	Loader panel	Gold model	1					
23	204 8262 002	1P Pin jack	JK201	1					
24	204 8416 007	Mini jack	JK202	1					
25	204 8487 007	2P pin jack	JK301	1					
26	203 3959 003	2P inlet	CB500	1					
▲ 27	233 9682 003	Power transformer	T500	1					
● 28	105 1157 118	:Rear panel		1					
29	337 0040 001	CD mechanism unit	CDM14-5BD10	1					
30	412 2814 044	Card spacer	L=6	1					
31	449 0050 035	Card spacer		2					
32	009 0128 002	:23P FFC cable	L=100	1					
● ★	513 2359 006	Inst. label		1					
● ★	513 1642 002	No.sheet		1					
● ★	513 2358 007	Laser caution		1					
SCREWS									
101	473 7508 017	Screw 3 × 10 BK		9					
102	473 7002 021	Screw 3 × 8 BK		16					
104	473 7007 013	Screw 4 × 10 BK	Black model	4					
104	473 4801 005	Screw 4 × 8	Gold model	4					

OPTICAL PICK-UP UNIT

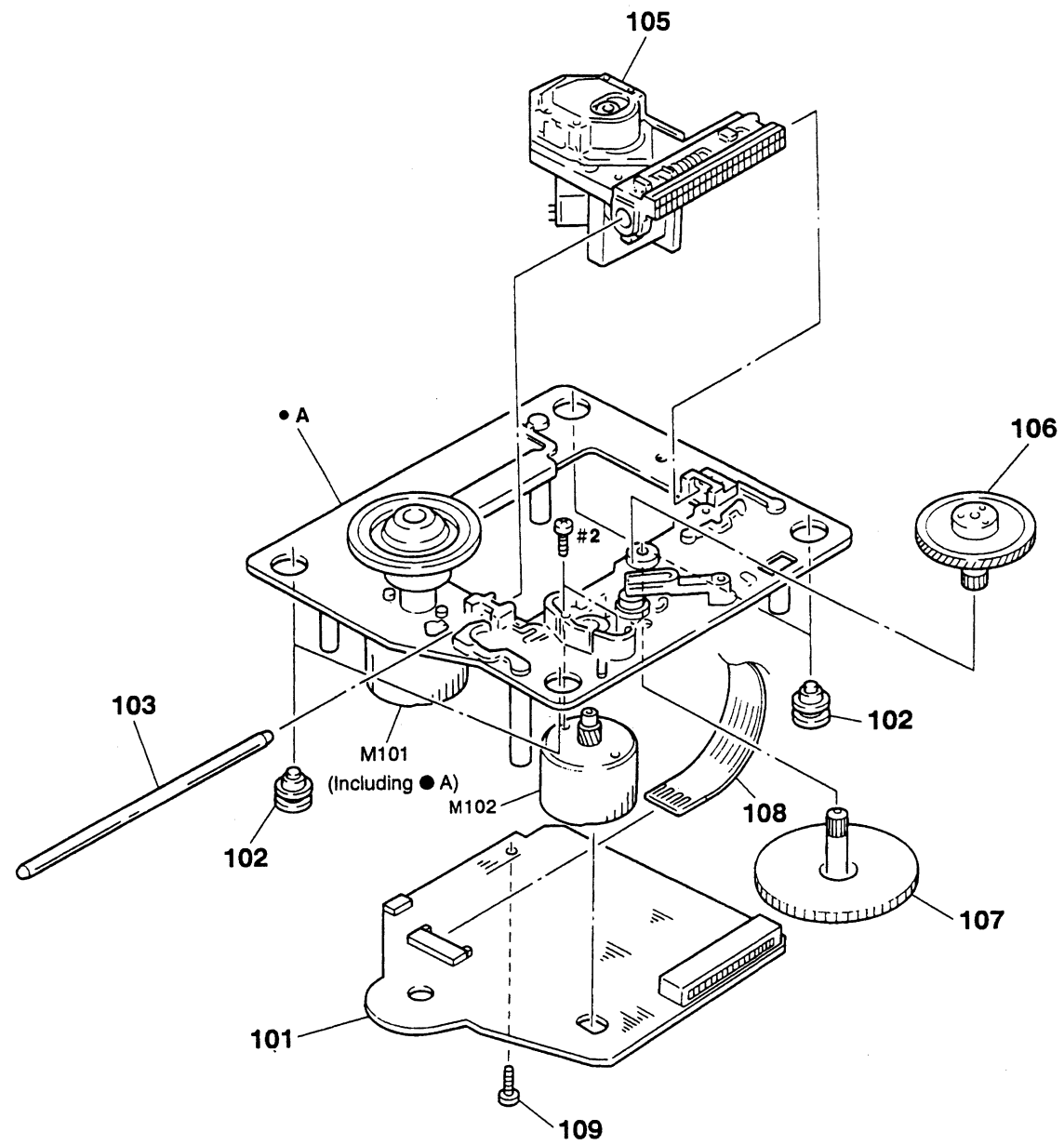

PARTS LIST OF OPTICAL PICK-UP UNIT

Ref. No.	Part No.	Part Name	Remarks	Ref. No.	Part No.	Part Name	Remarks
101	SA4 6494 32A	P.W.B. Ass'y	See Page 27, 28	108	S15 7500 111	Flat Cable	
102	S49 3312 601	Insulator Rubber		M101	SX4 9175 233	Motor (Spindle) Ass'y	
103	S49 1756 501	Sled Shaft		M102	SX4 9175 041	Motor (Sled) Ass'y	
105	499 0191 009	Optical PU KSS240A		109	S49 5162 001	Screw	
106	S49 1756 701	Gear (M)		#2	471 1810 019	Screw 2x3	
107	S49 1756 401	Gear (P)					

WIRING DIAGRAM

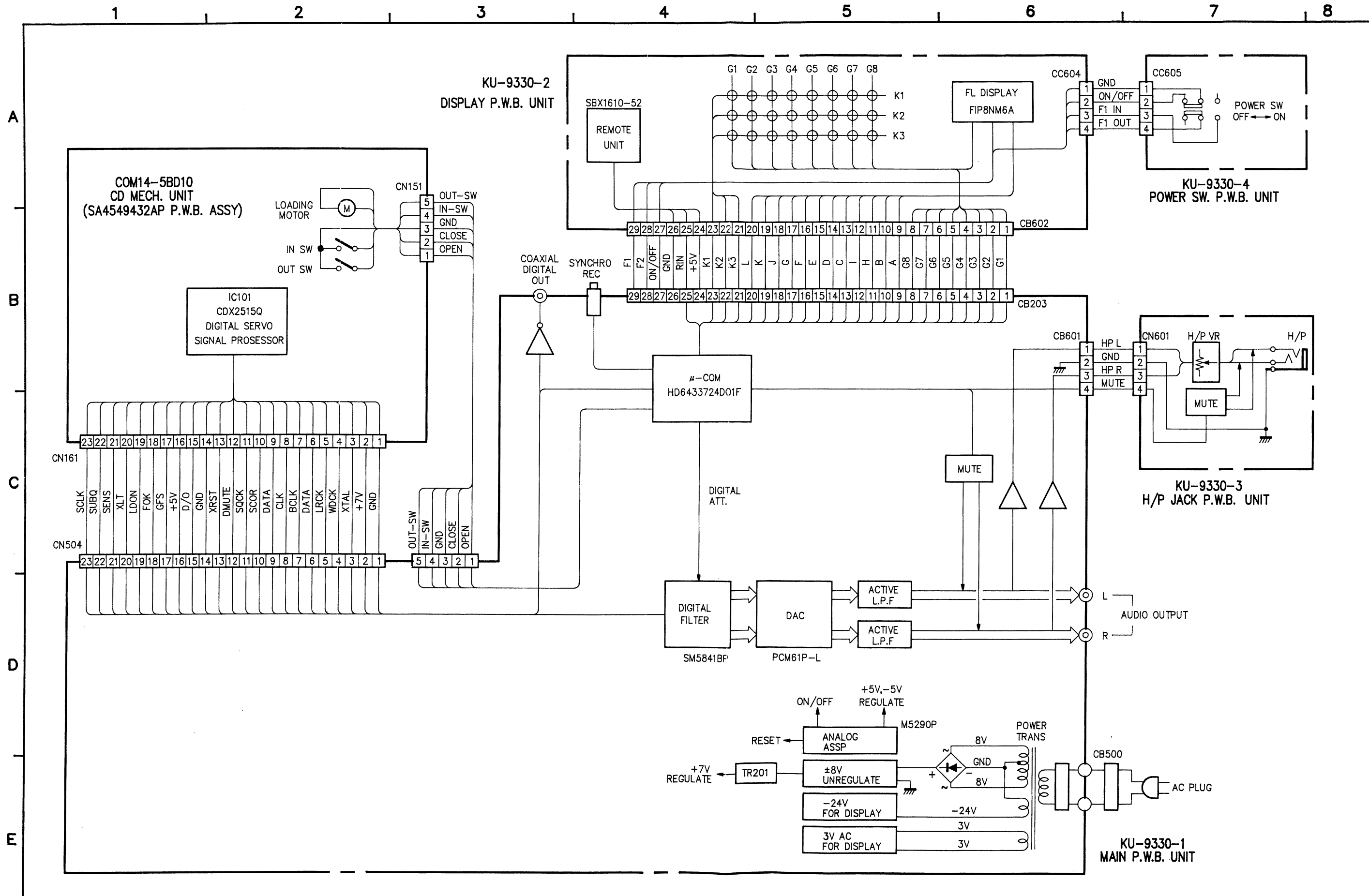

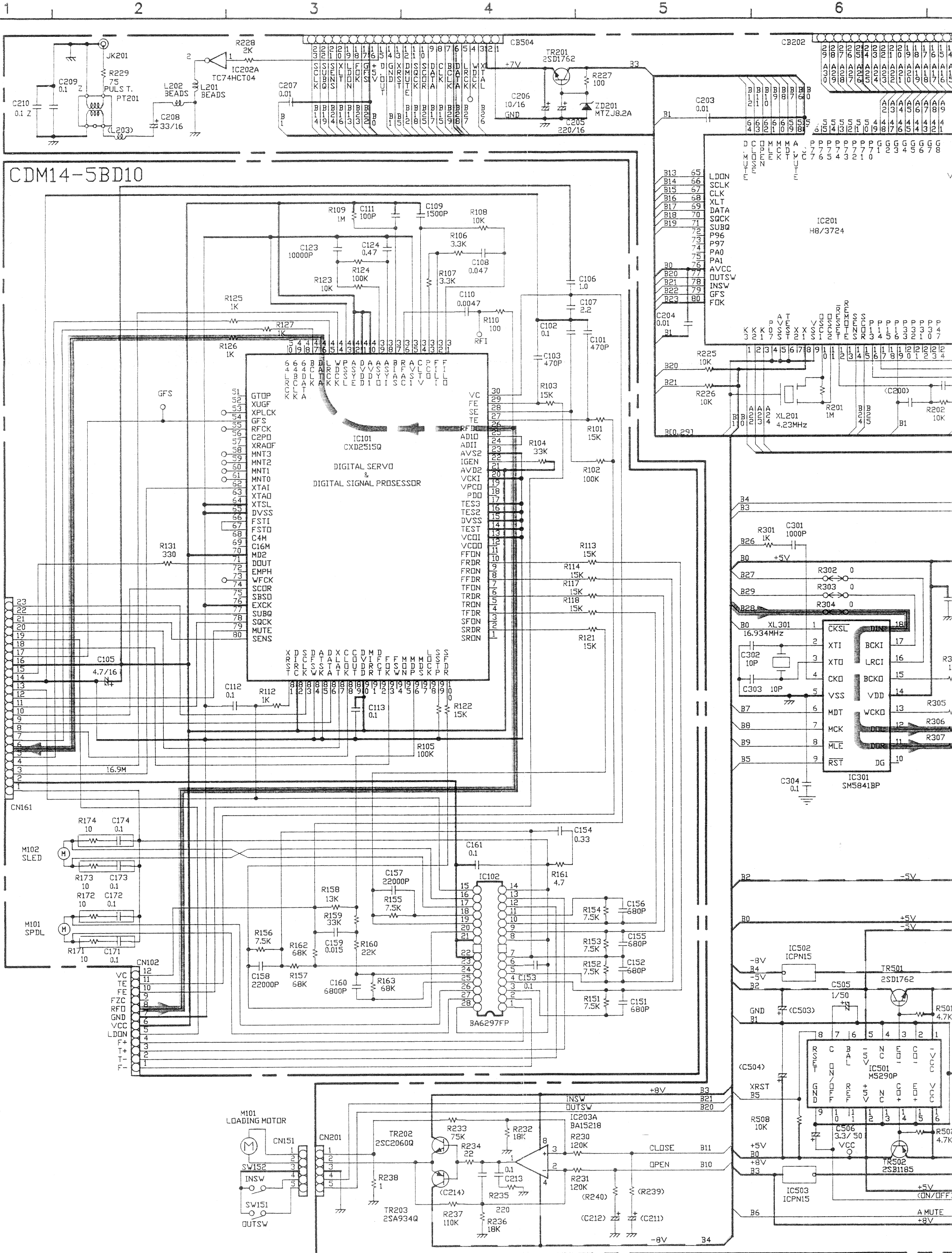

SCHEMATIC DIAGRAM

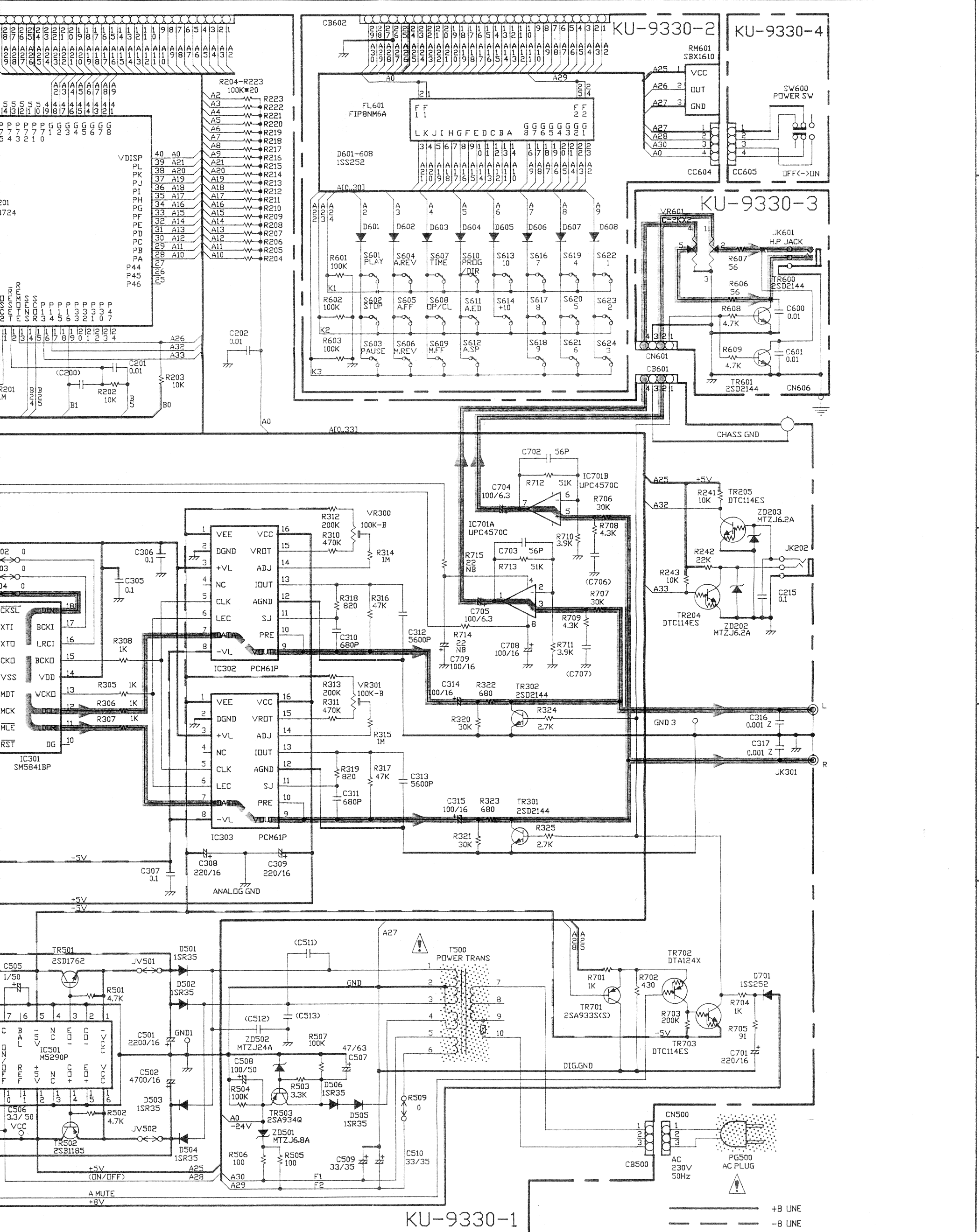

NOTES
 ALL RESISTANCE VALUES IN OHM. k=1,000 OHM, M=1,000,000 OHM.
 ALL CAPACITANCE VALUES IN MICRO FARAD. P=MICRO-FARAD.
 EACH VOLTAGE AND CURRENT ARE MEASURED AT NO LOAD.
 CIRCUIT AND PARTS ARE SUBJECT TO CHANGE WITHOUT NOTICE.

6 7 8 9 10 11



WARNING:
Parts marked with this symbol  have critical characteristics. Use ONLY replacement parts recommended by the manufacturer.

CAUTION:
Before returning the unit to the customer, make sure you make either (1) a leakage current check or (2) a line to chassis resistance check. If the leakage current exceeds 0.5 milliamps, or if the resistance from chassis to either side of the power cord is less than 240 kohms, the unit is defective.

WARNING:
DO NOT return the unit to the customer until the problem is located and corrected.

NOTES:
Circuit and parts are subject to change without prior notice.

IN OHM. k=1,000 OHM, M=1,000,000 OHM
S IN MICRO FARAD. P=MICRO-MICRO FARAD
CURRENT ARE MEASURED AT NO SIGNAL INPUT CONDITION.
SUBJECT TO CHANGE WITHOUT PRIOR NOTICE.

A
B
C
D
E
F
G
H