

## Circuit Diagram

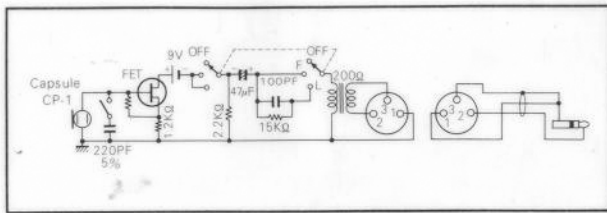

## Dimensions

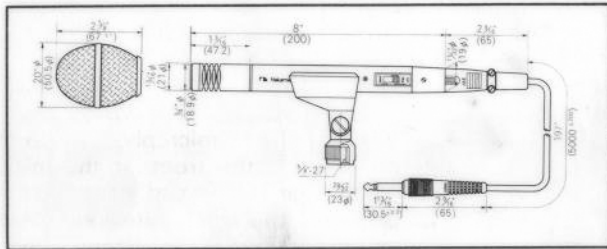

## Optional Capsules

### CP-3

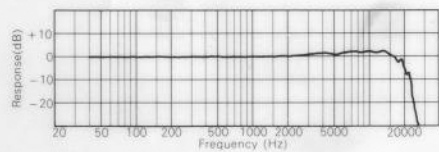
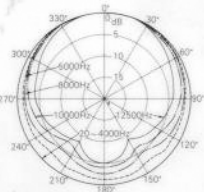

### CP-4

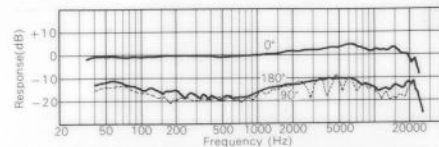
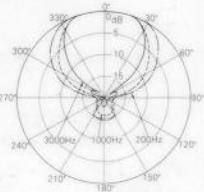
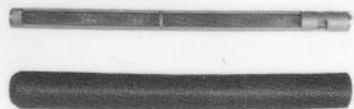

## Exploded View

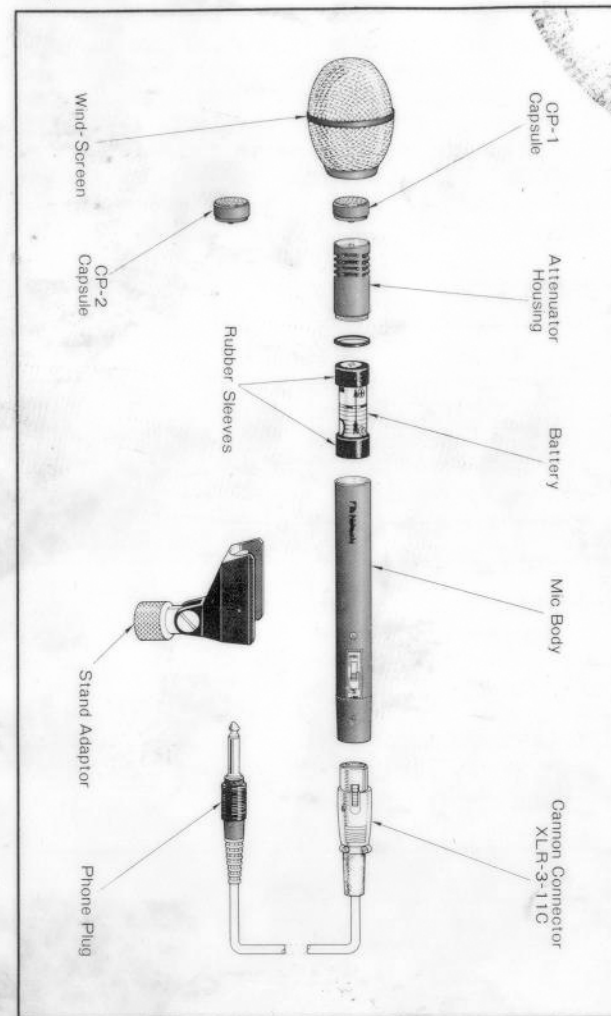

## NAKAMICHI RESEARCH (U.S.A.), INC.

West Coast Office  
1101 Colorado Avenue,  
Santa Monica, Calif. 90404  
Phone: (213) 451-5901  
Telex: 652429 (NAKREI SNM)

New York Office  
220 Westbury Avenue,  
Carle Place, N.Y. 11514  
Phone: (516) 333-5440  
Telex: 144513 (NAKREI CAPL)

## NAKAMICHI RESEARCH INC.

1-153 Suzukicho, Kodaira, Tokyo  
Phone: (0423) 42-1111  
Telex: 2832610 (NAKREI J)  
Cable: NAKREI KKB

# Nakamichi CM-300

Electret Condenser  
Microphone

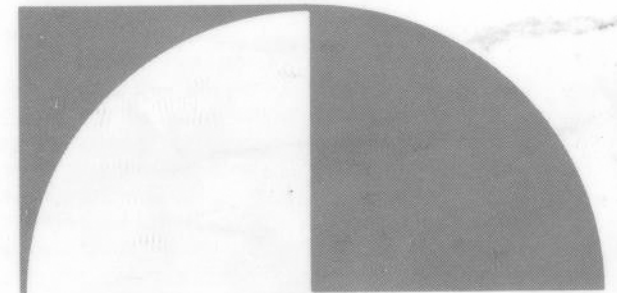

The Nakamichi CM-300 is a studio quality electret condenser microphone providing the following performance characteristics and features:

- uniform frequency response
- high sensitivity
- wide dynamic range
- low distortion and coloration
- ruggedness and dependability
- self-contained power supply and preamplifier
- interchangeable capsules
- built-in 10 dB pre-electronics attenuator
- built-in proximity effect compensator

## 1. Battery Installation

Remove the attenuator housing by unscrewing it. Install the battery (supplied with microphone) with the positive (+) terminal facing the front of the microphone. Make sure that the rubber end sleeves are on the ends of the battery - this will ensure a snug fit inside the microphone body. Battery life is approximately 220 hours of continuous use (longer for intermittent use). The 9.1V Mercury battery (type H-7D/A) may be replaced with the more readily available Mallory type TR-126 (or Eveready E-126). When using the latter, it will not be necessary to use the rubber end sleeves.

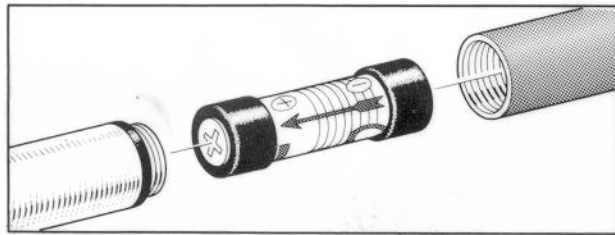

## 2. Cable Connection

The cable supplied with the CM-300 is wired for unbalanced operation, making the microphone immediately compatible with the microphone inputs found on Nakamichi cassette decks or any low impedance unbalanced phone jack mic inputs. Balanced lines should be avoided unless absolutely necessary (due to noise pick-up problems) since input transformers necessitated by balanced lines inevitably introduce coloration. Where balanced lines cannot be avoided, the CM-300 may be used with standard 2-conductor-plus-shield cable, terminating at the microphone end in a female Cannon XLR (3) type connector, to provide a fully balanced 200 ohm system.

## 3. "Off-Flat-Lo Cut" Switch

Always leave this switch in the "off" position when the CM-300 is not in use to conserve battery power. For normal applications use the microphone in the "flat" mode. When close-miking with the cardioid (CP-1) capsule, push the switch into the "Lo Cut" position. This will provide compensation for proximity effect as shown in the frequency response diagram.

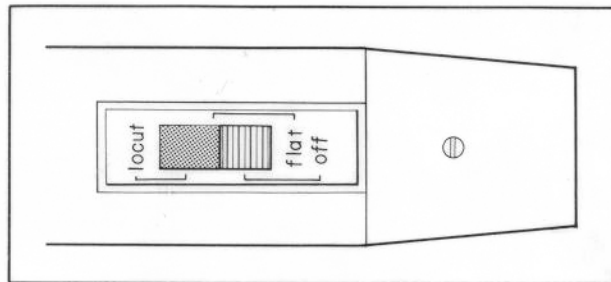

## 4. Attenuator Operation

It may become necessary under high sound level applications to attenuate the signal going to the CM-300 preamplifier housed in the body. Access to the built-in 10 dB pad is gained by unscrewing and removing the capsule. Using a thin stylus, move the lever to the desired position as shown on the diagram below.

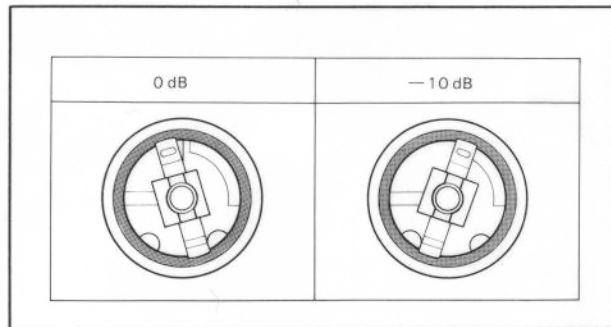

## 5. Interchanging Capsules

Interchange the electret elements in the following manner:

1. Remove existing capsule by unscrewing it from attenuator housing. (see exploded view)
2. Attach desired capsule in reverse process.  
DO NOT OVERTIGHTEN.

CP-1

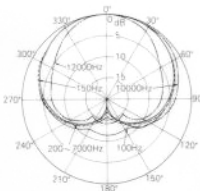

CP-2

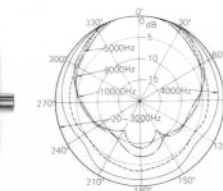

## Frequency Response

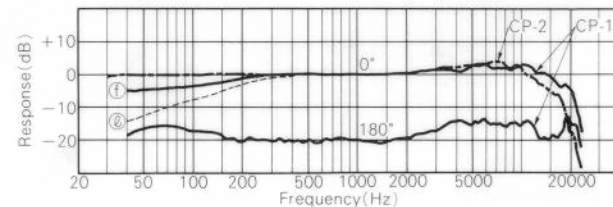

## Specifications:

	CP-1 (Cardioid)	CP-2 (Omni)
Frequency Range	30-18,000Hz $\pm$ 3.5dB	20-16,000Hz $\pm$ 3.5dB
Output Impedance (1 kHz)	200 ohms Balanced	
Sensitivity (1kHz 0dB = 1V/ $\mu$ bar)	-76dB $\pm$ 2.5dB	
Attenuation Pad	-10dB	
Signal to Noise Ratio (Weighted)	Better than 50dB	
Maximum SPL At 3% Distortion	138 dB	
Current Consumption	Less than 1mA	
Operating Voltage	7V-10V DC	
Battery	8.4 or 9.1V Mercury	
Dynamic Range	Better than 114dB	
Low Cut	-10dB/100Hz	

## Included Accessories

1. Connecting Cable (XLR to phone)
2. Battery
3. Stand Adaptor
4. Windscreen
5. CP-1 Cardioid Capsule
6. CP-2 Omni-directional Capsule
7. Foam padded case
8. Vinyl "gadget bag" carrying case (included with CM-300 x 3 tri-microphone set only)

## Optional Accessories

1. CP-3 Super-omnidirectional pinpoint Capsule
2. CP-4 Super-directional shotgun Capsule