

TC-K75

AEP Model
 UK Model
 US Model
 Canadian Model
 E Model

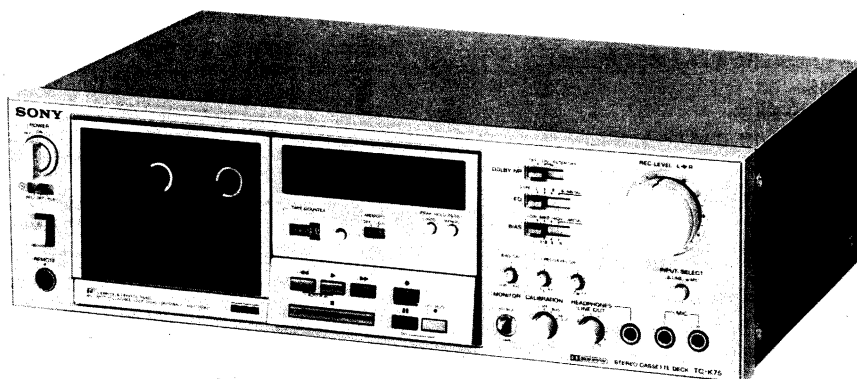

Photo: AEP, UK, US, E model

'Dolby' and the double-D symbol are the trade marks of Dolby Laboratories. Noise reduction system manufactured under license from Dolby Laboratories.

STEREO CASSETTE DECK

SPECIFICATIONS

GENERAL

- Power Requirements:** AEP model
 220V ac ~, 50/60 Hz
 (240V ac ~ adjustable by authorized Sony personnel)
- UK model
 240V ac ~, 50/60 Hz
 (220V ac ~ adjustable by authorized Sony personnel)
- US, Canadian model
 120V ac, 60 Hz
- E model
 110, 120, 220 or 240V ac ~,
 50/60 Hz
- Power Consumption:** 28W (AEP, UK, E model)
 26W (US, Canadian model)

- Dimensions:** Approx. 430(w) x 130(h) x 290(d) mm
 17(w) x 5¹/₈(h) x 11¹/₂(d) inches
 (AEP, UK, US, E model)
- Approx. 460(w) x 130(h) x 290(d) mm
 18¹/₈(w) x 5¹/₈(h) x 11¹/₂(d) inches
 (Canadian model)
- including projecting parts and controls
- Weight:** Approx. 6.3kg, 13 lb 14 oz (AEP, UK, US, E model)
- Approx. 7kg, 15 lb 7 oz (Canadian model)

— Continued on page 2 —

SAFETY-RELATED COMPONENT WARNING!!

COMPONENTS IDENTIFIED BY SHADING AND MARK  ON THE SCHEMATIC DIAGRAMS, EXPLODED VIEWS AND IN THE PARTS LIST ARE CRITICAL TO SAFE OPERATION. REPLACE THESE COMPONENTS WITH SONY PARTS WHOSE PART NUMBERS APPEAR AS SHOWN IN THIS MANUAL OR IN SUPPLEMENTS PUBLISHED BY SONY.

ATTENTION AU COMPOSANT AYANT RAPPORT A LA SÉCURITÉ !

LES COMPOSANTS IDENTIFIÉS PAR UN TRAMÉ ET UNE MARQUE  SUR LES DIAGRAMMES SCHEMATIQUES, LES VUES EXPLOSÉES ET LA LISTE DES PIÈCES SONT CRITIQUES POUR LA SÉCURITÉ DE FONCTIONNEMENT. NE REMPLACER CES COMPOSANTS QUE PAR DES PIÈCES SONY DONT LES NUMÉROS SONT DONNÉS DANS CE MANUEL OU DES SUPPLÉMENTS PUBLIÉS PAR SONY.

Tape Transport Mechanism Type	TCM-100V2	
	Specification	Test Equipment
Forward Torque	28–43 g·cm (0.39–0.59 oz·inch)	Sony torque meter CQ-102
Back Tension Torque	2.5–4.5 g·cm (0.04–0.06 oz·inch)	Sony torque meter CQ-102
Pinch Roller Pressure	<ul style="list-style-type: none"> • Take-up Side 280–380 g (10–13 oz) • Supply Side 180–280 g (7–10 oz) 	Spring scale or tension gauge

SONY

SERVICE MANUAL

TAPE RECORDER SECTION

Recording System: 4-track 2-channel stereo

Fast-forward and

Rewind Time: Approx. 80 sec. (with C-60)

Frequency Response: DOLBY NR OFF

AEP, UK, E model

- With TYPE IV cassette (Sony METALLIC)
 - 20–20,000 Hz
 - 30–18,000 Hz (± 3 dB)
 - 30–13,000 Hz (± 3 dB, 0 VU recording)
 - 30–18,000 Hz (DIN)
- With TYPE III cassette (Sony Fe-Cr)
 - 20–20,000 Hz
 - 30–18,000 Hz (± 3 dB)
 - 30–18,000 Hz (DIN)
- With TYPE II cassette (Sony CD- α)
 - 20–19,000 Hz
 - 30–17,000 Hz (± 3 dB)
 - 30–17,000 Hz (DIN)
- With TYPE I cassette (Sony BHF)
 - 20–17,000 Hz
 - 30–15,000 Hz (± 3 dB)
 - 30–15,000 Hz (DIN)

US, Canadian model

- With TYPE IV cassette (Sony METALLIC)
 - 20–20,000 Hz
 - 30–18,000 Hz (± 3 dB)
 - 30–13,000 Hz (± 3 dB, 0 VU recording)
- With TYPE III cassette (Sony Fe-Cr)
 - 20–20,000 Hz
 - 30–18,000 Hz (± 3 dB)
- With TYPE II cassette (Sony EHF)
 - 20–19,000 Hz
 - 30–17,000 Hz (± 3 dB)
- With TYPE I cassette (Sony HFX)
 - 20–17,000 Hz
 - 30–15,000 Hz (± 3 dB)

Wow and Flutter: 0.04% WRMS (NAB) } (AEP, UK, E model)
 $\pm 0.14\%$ (DIN) }

0.04% WRMS (US, Canadian model)

S/N Ratio: DOLBY NR OFF

AEP, UK, E model

- With TYPE III cassette (Sony Fe-Cr)
 - 60 dB at peak level (NAB)
 - 59 dB (DIN, 1975, rev.)
- With TYPE II cassette (Sony CD- α)
 - 58 dB at peak level (NAB)

US, Canadian model

- With TYPE III cassette (Sony Fe-Cr)
 - 60 dB at peak level
- With TYPE II cassette (Sony EHF)
 - 58 dB at peak level

DOLBY NR ON

Improved by 5 dB at 1 kHz, 10 dB above 5 kHz

Total Harmonic Distortion: 0.8% (with Sony Fe-Cr cassette)

Bias Frequency: 105 kHz

Inputs: Microphone inputs (phone jacks) 2
 sensitivity 0.25 mV (-70 dB)
 for a low-impedance microphone
 Line inputs (phono jacks) 2
 sensitivity 77.5 mV (-20 dB)
 input impedance 50 k Ω

Outputs: Variable line outputs (phono jacks) . . . 2
 output level 0.435 V (-5 dB)
 at load impedance 50 k Ω
 with LINE OUT level control at "10"
 suitable load impedance more than
 10 k Ω

Fixed line outputs (phono jacks) 2
 output level 0.435 V (-5 dB)
 at load impedance 50 k Ω
 Suitable load impedance
 more than 10 k Ω

Headphone output 1
 output level -20 to -50 dB
 at load impedance 8 Ω

LED PEAK PROGRAM METERS

Response Range: -40 dB to $+8$ dB

Frequency Response: 20 Hz $-20,000$ Hz ± 1.5 dB

Response Time: 1 millisecond

Decay Time
 (from 0 dB to -20 dB): 750 milliseconds

Overshoot: None

Indicator Elements: 16 elements for each channel

0 dB = 0.775 V

SERVICING NOTE

When the top cover is removed, the internal photo transistor may pick up stray light and shut the set off.

MODEL IDENTIFICATION

— Specification Label —

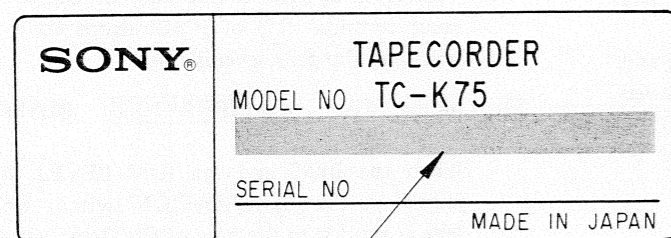

- US, Canadian Model: AC 120V 60Hz 26W
- AEP model: AC 220V~ 50/60Hz 28W
- UK model: AC 240V~ 50/60Hz 28W
- E model: AC 110, 120, 220, 240V~ 50/60Hz 28W

— Power Cord —

E model: euro-plug 1-534-817-XX

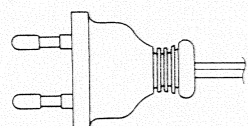

E model: parallel-blade plug 1-551-473-31

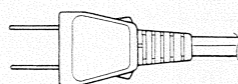

Handling Precautions for MOS ICs

Generally, the insulation resistance of the oxide layer in MOS IC structures is very high, and the oxide layer is very thin. Because of this, it is possible that the static voltages usually present on clothes and the human body will be enough to generate a potential difference across the insulator, high enough to cause a breakdown of the insulating layer.

The following precautions should be taken while handling these ICs.

(Particular care should be taken under conditions of low humidity.)

Precautions in Replacing MOS ICs

1. Store new ICs by inserting them into a urethane-polyester cushion (which is somewhat conductive), or wrapping it in aluminum foil, so that all the pins are at the same potential. (The ICs should be stored in that manner until mounted on the circuit board.)

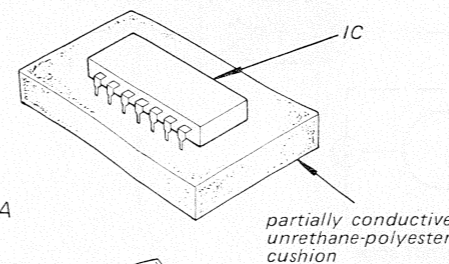

Fig. A

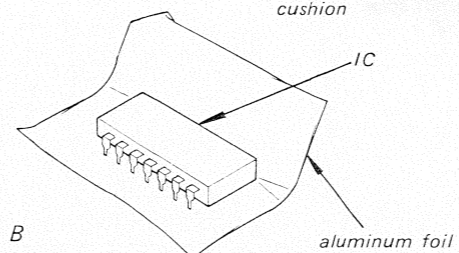

Fig. B

2. Check the soldering iron for possible power-line leakage current. Make sure that there is no leakage path by connecting an ohmmeter to the tip of the soldering iron and the plug as shown in Fig. C. If there is a leakage path, use some other soldering iron.

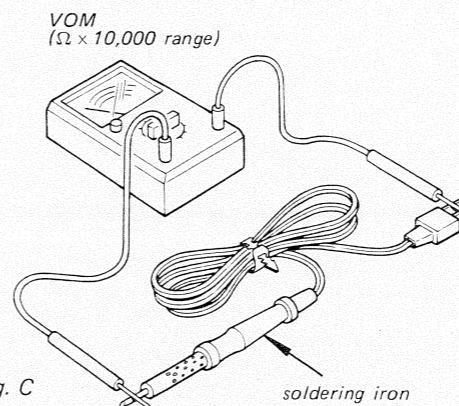

Fig. C

3. Equalize any potential difference between the clothes, the tools in use, the work bench, the set being worked on, and the packaged IC by touching them all in succession with the hands or a conductive wire or tool.
4. The following are effective methods for handling ICs that remove the potential difference across the oxide layer.
 - Use a paper clip modified by soldering in a wire braid insert.

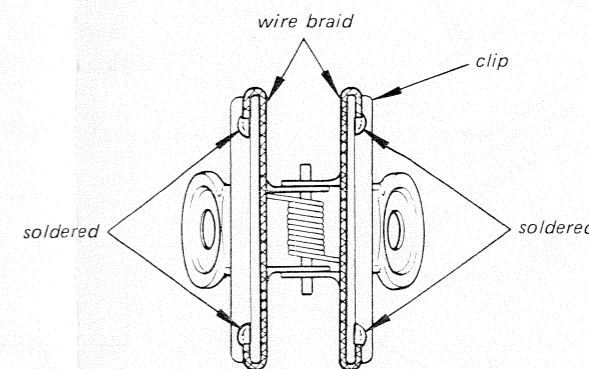

Fig. D

Make sure that there is no solder on the inside.

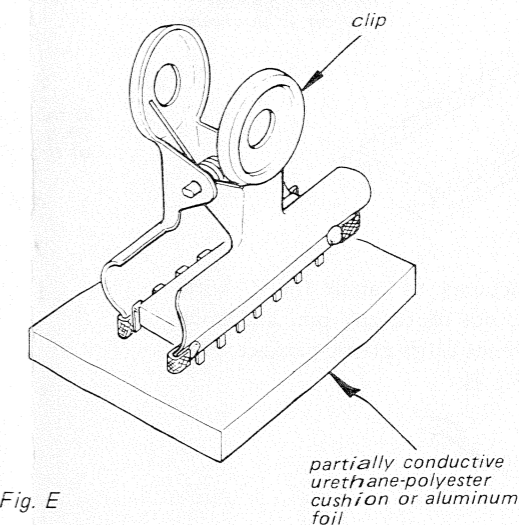

Fig. E

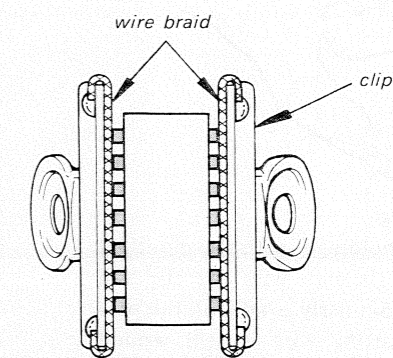

Fig. F

Make sure that all the pins are in contact with the wire braid (all the pins will then be at the same potential.).

- Take a short length of fine bare wire and wind it around the IC so that it shorts all the pins of the IC, while it is still in the urethane-polyester cushion or aluminum foil. This ensures that all the pins are at the same potential.

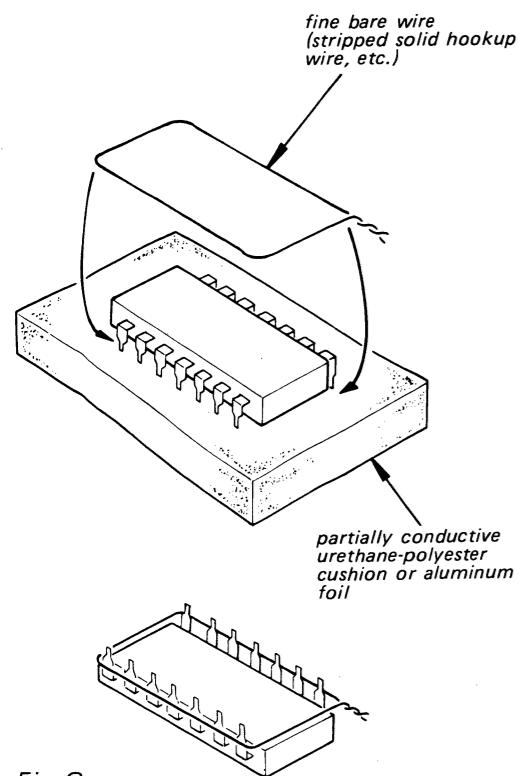

Fig. G

- When it is necessary to handle the IC with the fingers, do not touch any pin, and hold the IC at the ends of its plastic-package case as shown in Fig. H.

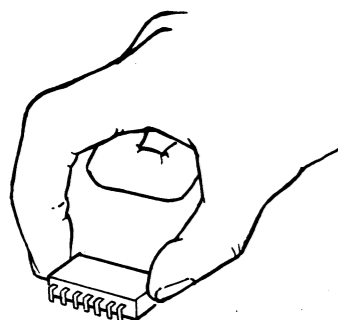

Fig. H

- Method of Mounting
Insert the IC while holding it with the modified clip, and solder all the pins with the clip still shorting the pins. (Similarly, solder all the pins while the bare shorting wire is still wound around them.). Remove the clip or the bare shorting wire only after all the pins have been soldered.

Precaution while Checking C-MOS ICs

The C-MOS ICs (Complementary MOS) are MOS ICs that have their output sections made up of N-channel and P-channel push-pull stages to increase their speed of operation. If the output terminal of these ICs comes into contact with B+ or B- voltage, then the FET which is ON at that time will either become shorted or open.

This is valid for all the output sections that are connected together by the interconnections. Even the circuits that are physically separated (and not on the same board) can be destroyed simultaneously.

Example:

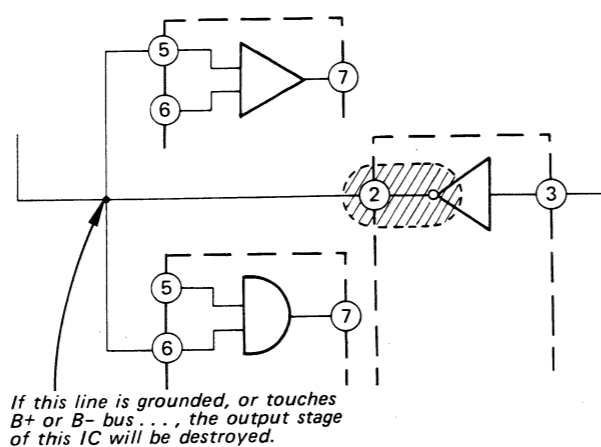

Fig. I

1-1. CIRCUIT OPERATION

This set is equipped with an LED peak program meter, which indicates the input signal level (as a bar graph).

The following explanations describe the operation of each of the circuit.

1. IC601 Input Circuit

Input signal **A** (waveform **A**) is amplified by Q106 and is applied to IC103 in the LOG converter circuit. By the characteristic of a diode, the input signal is logarithmically compressed and waveform **A** changes into waveform **B**.

The peak of signal **B** is detected by D105 and smoothed by C132, Then it is applied to terminal **(11)** of IC601 as dc voltage (waveform **C**). Q108 controls the input current which is applied to IC601.

2. LED Indication Circuit

The LEDs turn on when the anode and the cathode signals drop to a LOW level at the same time.

ex) LINE OUT output -5dB

D, **F** : LOW level

waveform **H** - **O** : anode, cathode: LOW level

L-CH/R-CH : LEDs 1~8 turn on
(See Diagram 1.)

LED MATRIX DIAGRAM

anode signal \ cathode signal	L-CH		R-CH	
	D	E	F	G
H	1	9	1	9
I	2	10	2	10
J	3	11	3	11
K	4	12	4	12
L	5	13	5	13
M	6	14	6	14
N	7	15	7	15
O	8	16	8	16

Diagram 1.

(When either two of the signals **D** - **G** and of **H** - **O** drop to LOW level, the LEDs shown in the diagram turn on.)

3. Peak Hold Reset Circuit

1) Mode: S107 **AUTO**
The trigger pulse generated by Q601 (PUT= Programmable Unijunction Transistor) is applied to the base of Q602. The reset signal is applied to the reset terminal **(12)** of IC601 at intervals of 2.25 seconds and the peak level is reset.

2) Mode: S107 **MANUAL**
When the MANUAL switch is turned on, B+ voltage is applied to the base of Q602. Then reset terminal **(12)** of IC601 drops to a LOW level and the peak level is reset.

3) Mode: S102 **CALIBRATION** BIAS/REC LEVEL
When the BIAS and the REC LEVEL are adjusted by the CALIBRATION switch, B+ voltage is applied to the base of Q602 and the peak level (of the meter) is not indicated.

Measuring Condition
 LINE IN: 1 kHz, 0.25V (-10 dB)
 LINE OUT: 0.44V (-5 dB)
 Mode: record/forward
 MONITOR SWITCH: SOURCE

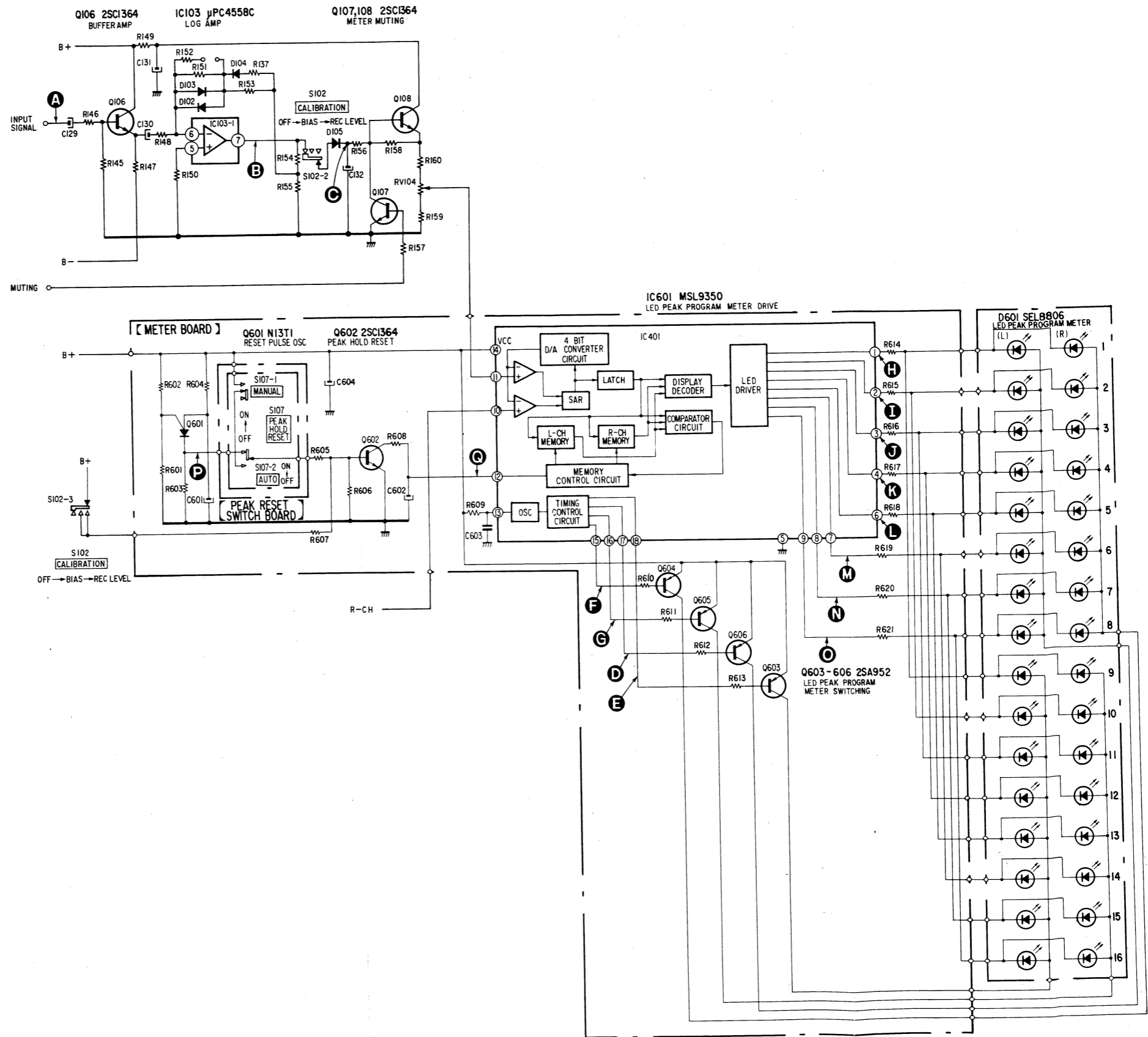
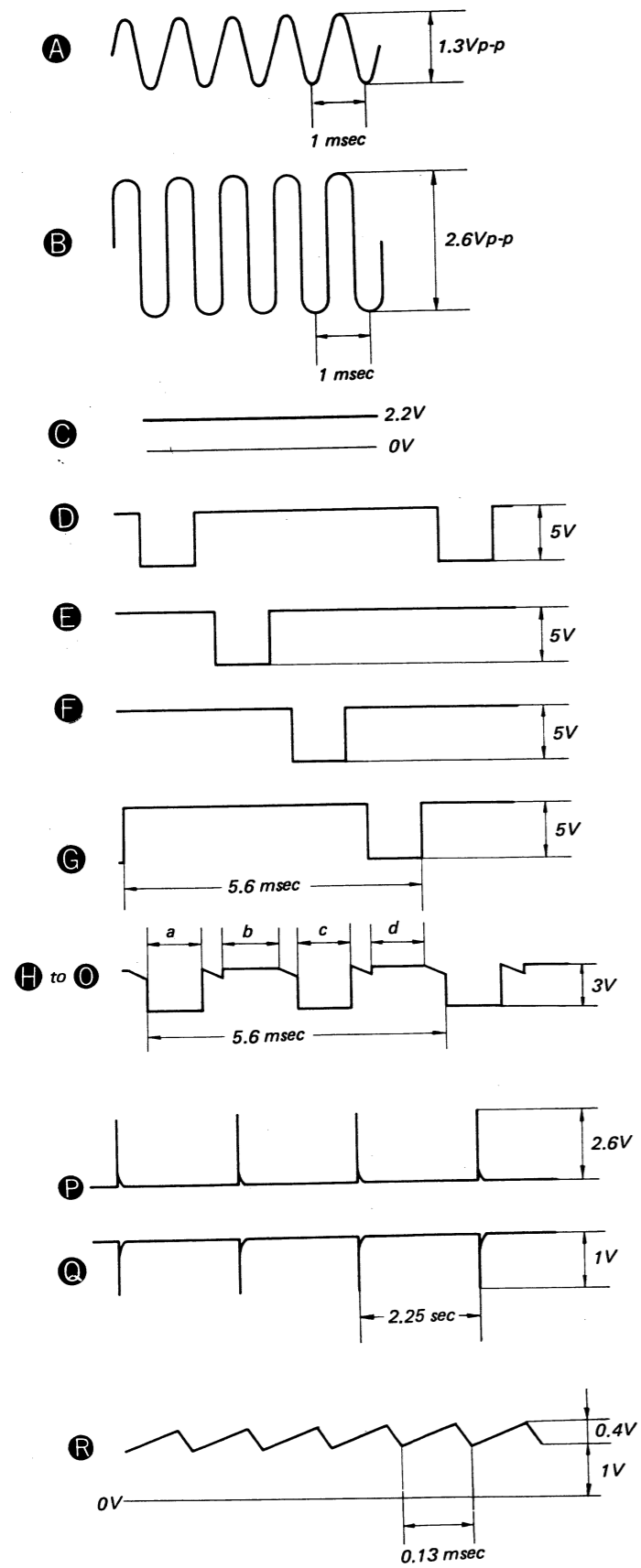

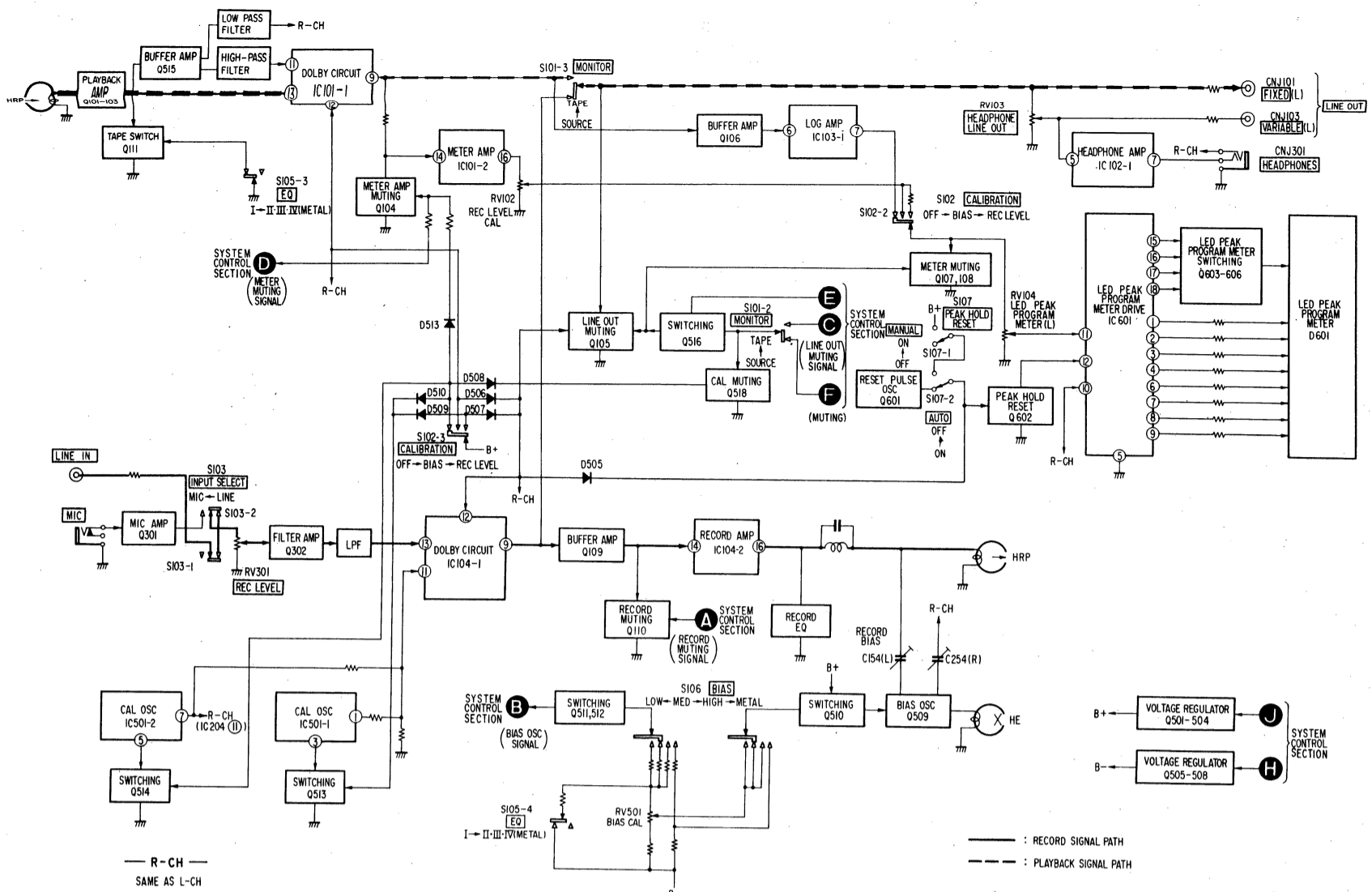

TC-K75 TC-K75

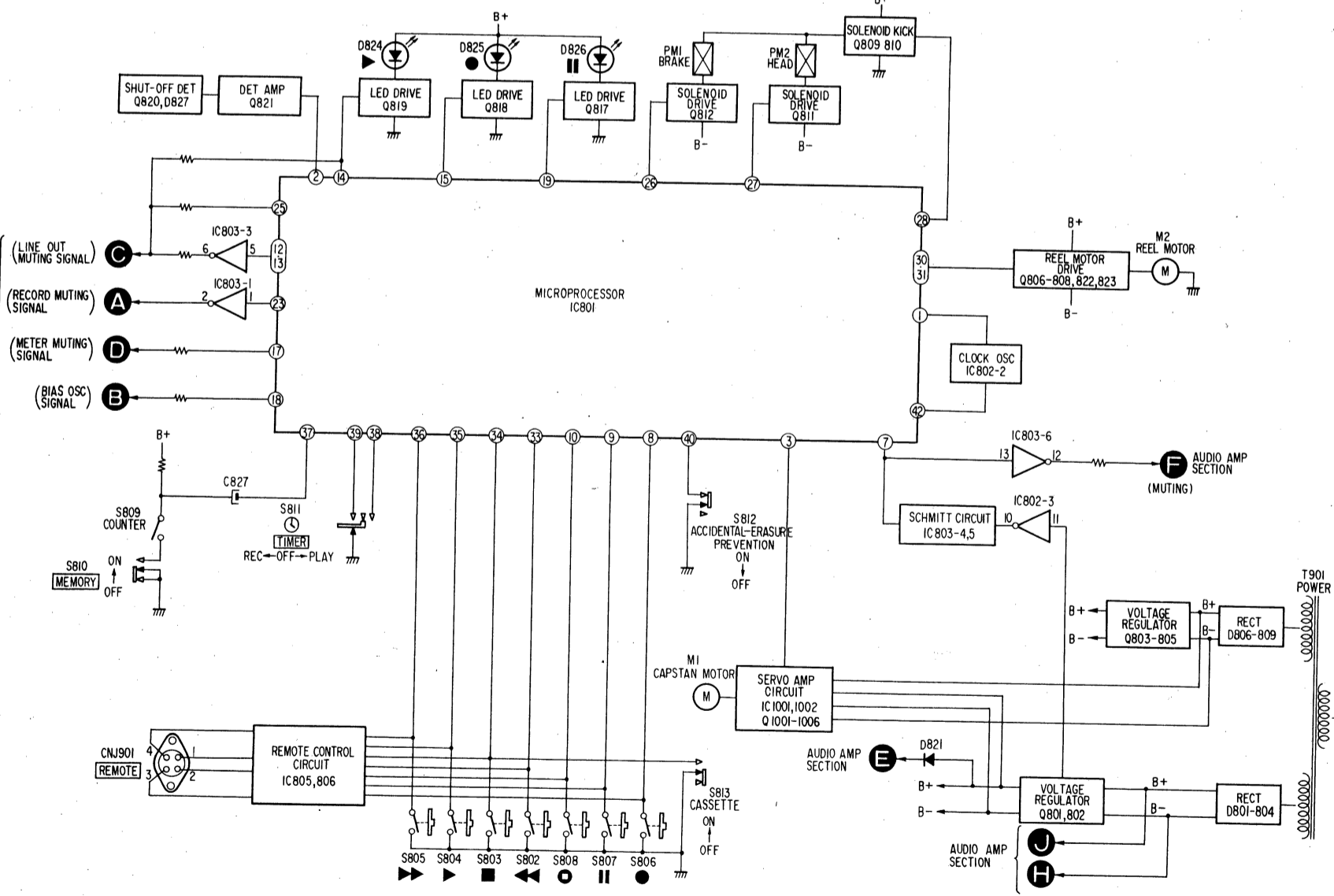

SECTION 2 DISASSEMBLY

- Follow the disassembly procedure in the numerical order given.

TOP COVER/FRONT PANEL/BOTTOM PLATE REMOVAL

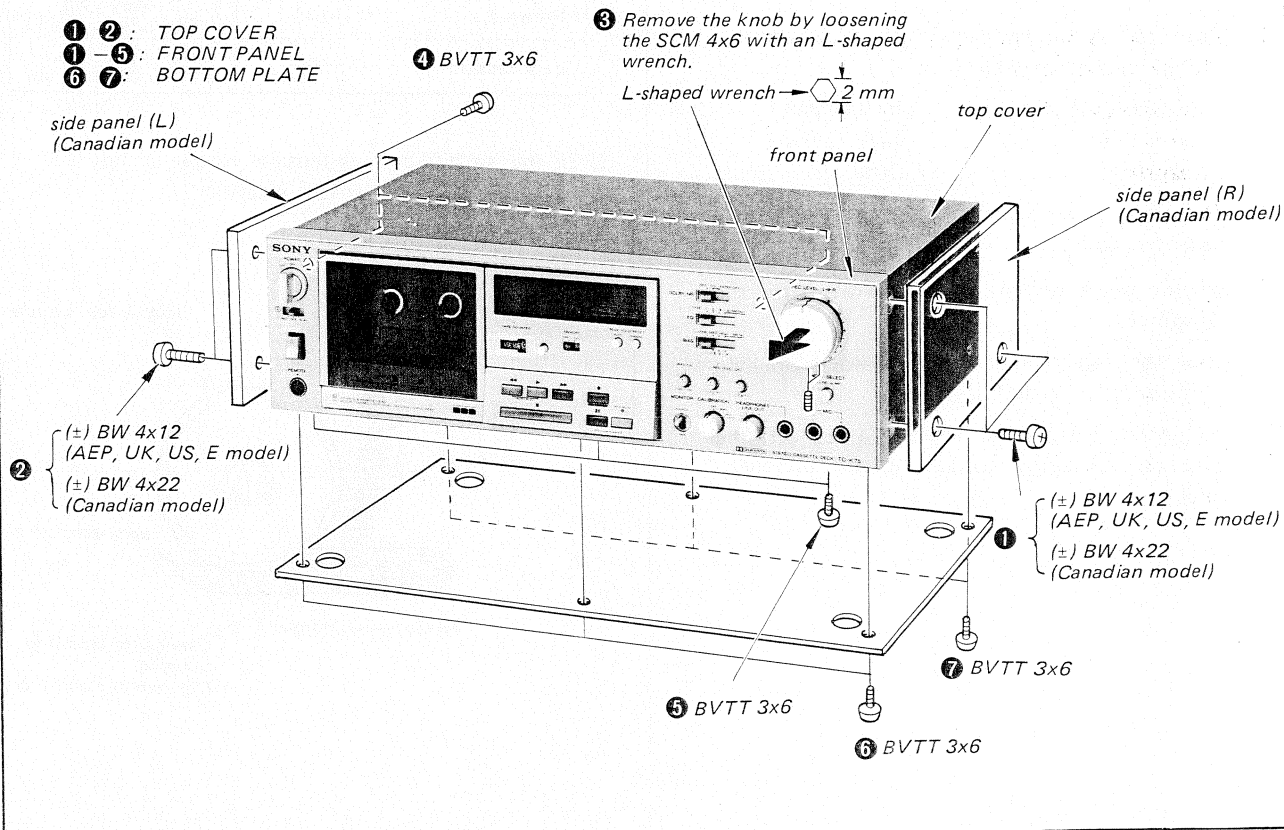

CASSETTE-HOLDER LID REMOVAL

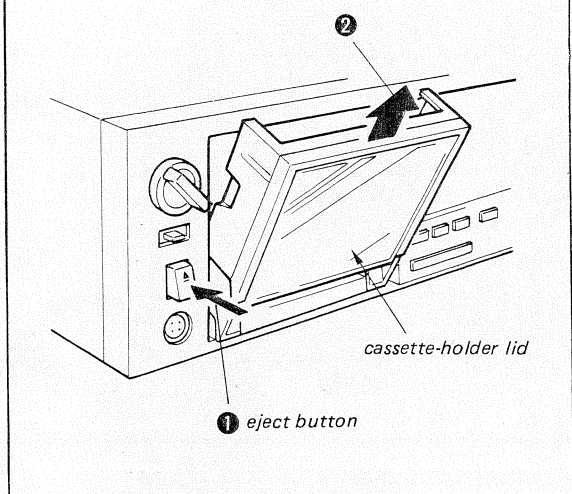

MECHANICAL BLOCK REMOVAL

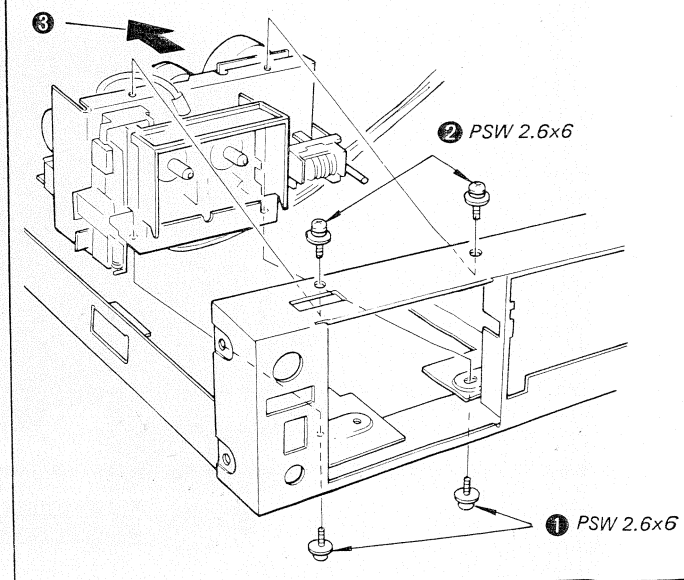

**SECTION 3
ADJUSTMENTS**

3-1. MECHANICAL ADJUSTMENTS

PRECAUTION

1. Clean the following parts with a denatured-alcohol-moistened swab:

record/playback head	pinch rollers
erase head	rubber belts
capstans	idlers
2. Demagnetize the record/playback head with a head demagnetizer.
3. Do not use a magnetized screwdriver for the adjustments.
4. After the adjustments, apply suitable locking compound to the parts adjusted.
5. The adjustments should be performed with the rated power supply voltage unless otherwise noted.

Torque Measurement and Back Tension Torque Adjustment

1.

Torque	Torque meter	Meter reading
Forward	CQ-102	28–43 g · cm (0.39–0.59 oz · inch)
Back tension	CQ-102	2.5–4.5 g · cm (0.04–0.06 oz · inch)
2. If the specified back-tension torque is not obtained, change the hooking position.

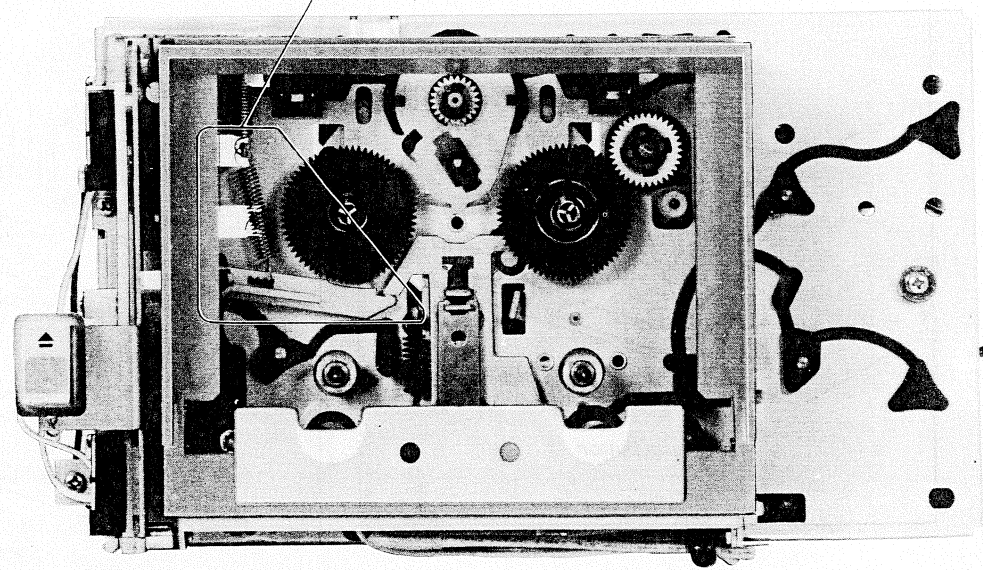

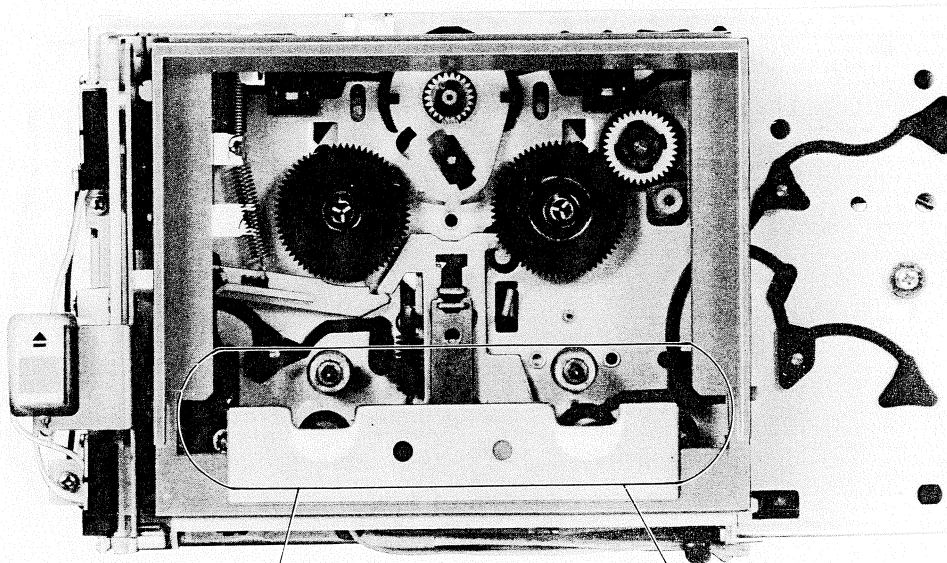

Head Height Adjustment

1. Prepare an adjustment cassette as shown below.

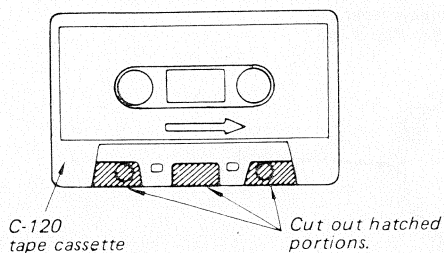

2. In playback mode and viewing from the front, adjust the head heights to eliminate tape curl and tape twist at portions shown by arrows.

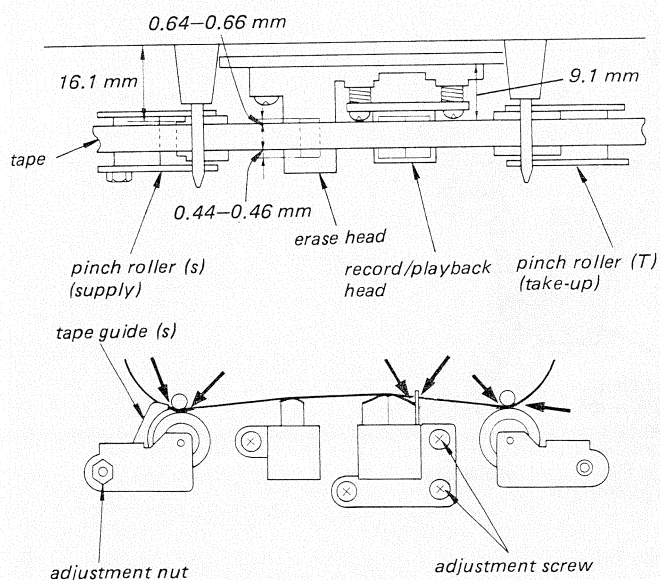

Pinch Roller Pressure Measurement

– Forward Mode –

- 1.

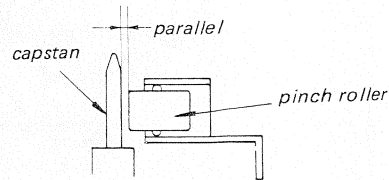

2. Slowly pull the pinch roller and read the spring scale or the tension gauge just when the pinch roller stops rotating.

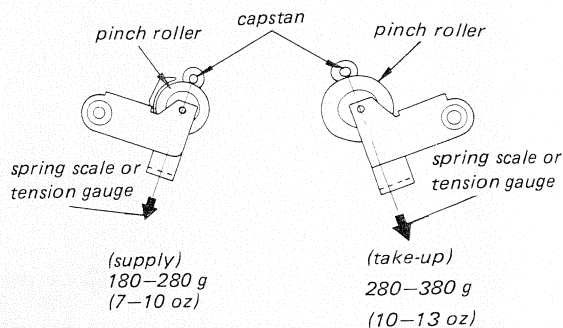

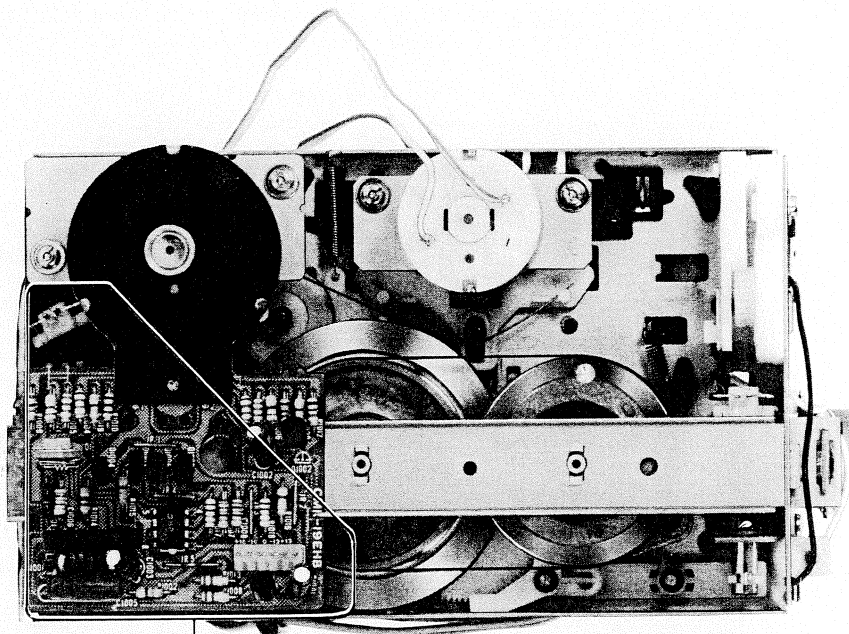

Brake Solenoid (PM1) Position Adjustment

— Stop Mode —

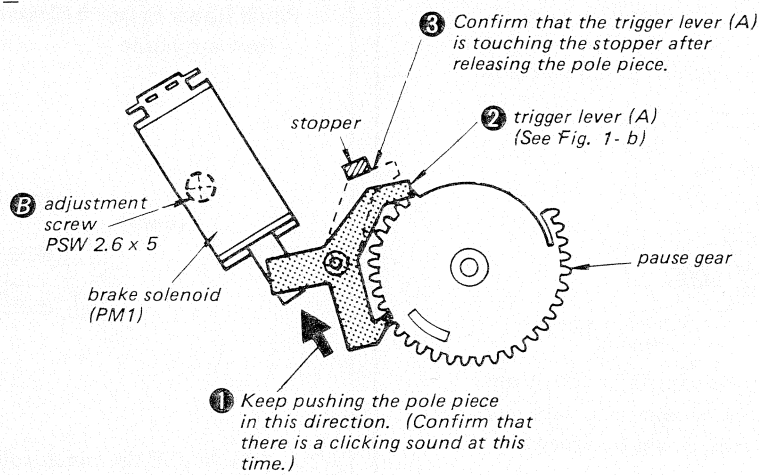

Fig. 1- a

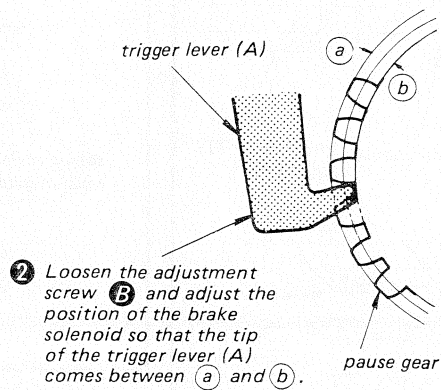
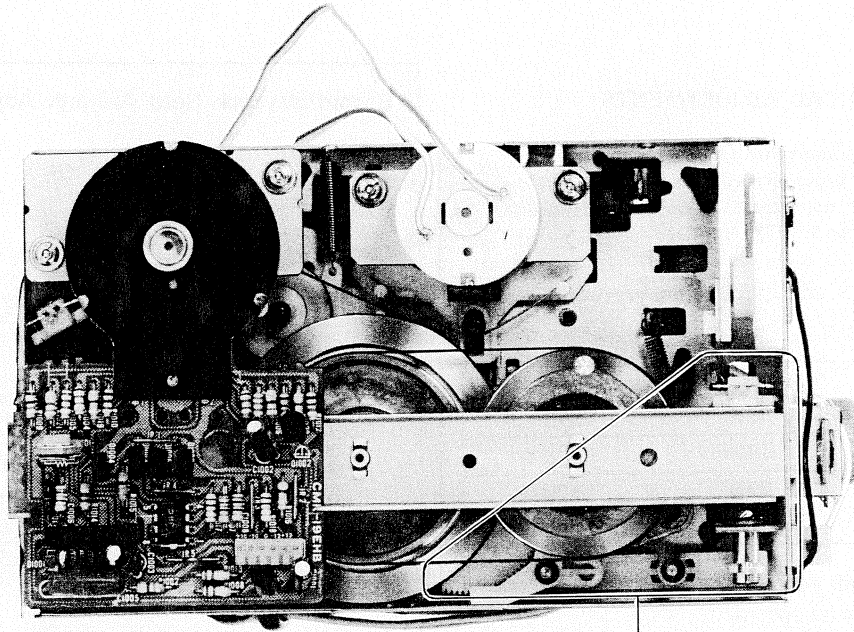

Fig. 1- b



Head Solenoid (PM2) Position Adjustment

— Stop Mode —

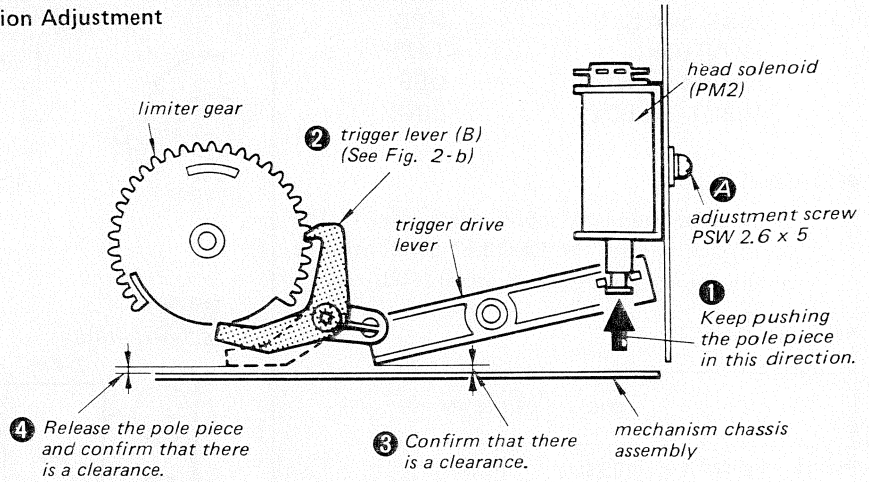

Fig. 2-a

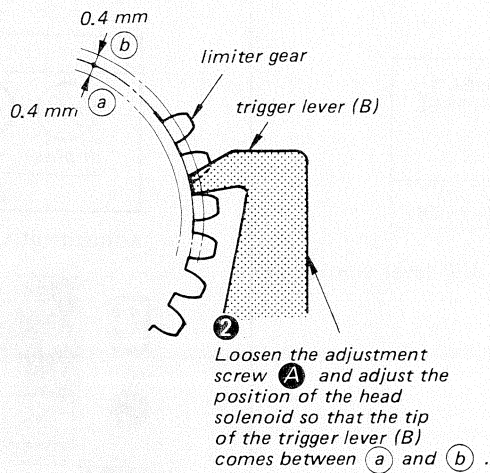

Fig. 2-b

3-2. ELECTRICAL ADJUSTMENTS

Note: The adjustment should be performed in the order given in this service manual. The adjustments should be performed for both L-CH and R-CH.

- Set the BIAS and EQ switches according to the tape as follows.

Tape	BIAS switch	EQ switch
CS-10	MED	TYPE I
CS-25	HIGH	TYPE II
CS-30	MED	TYPE III
CS-40	METAL	TYPE IV

- Switches and controls should be set as follows unless otherwise specified.

DOLBY NR switch:	OFF
EQ switch:	TYPE I
BIAS switch:	MED
MONITOR:	TAPE
CALIBRATION:	OFF
INPUT SELECT:	LINE

- Standard Record:

Deliver the standard input signal level to the input jack and set the REC LEVEL control to obtain the standard output signal level.

Standard Input Level

	MIC	LINE IN
source impedance	300 Ω	10 k Ω
input level	0.77 mV (-60 dB)	0.25 V (-10 dB)

Standard Output Level

	LINE OUT (FIXED)	HEAD-PHONES
load impedance	47 k Ω	8 Ω
output level	0.44 V (-5 dB)	77 mV* (-20 dB)

* with HEADPHONES/LINE OUT level control at "10".

Record/playback Head Azimuth Adjustment

Procedure:

- Mode: playback

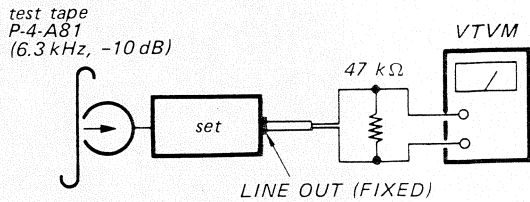

- Turn the adjustment screw for the maximum output levels. If these levels do not match, turn the adjustment screw where both of output levels match together within 0.5 dB.

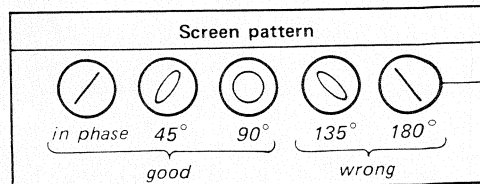
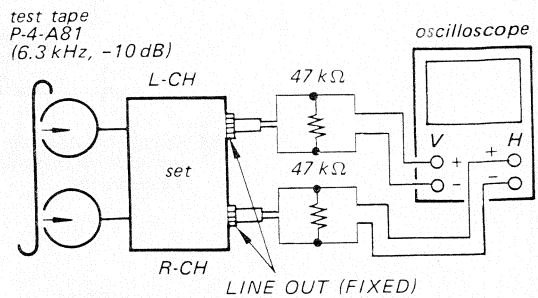
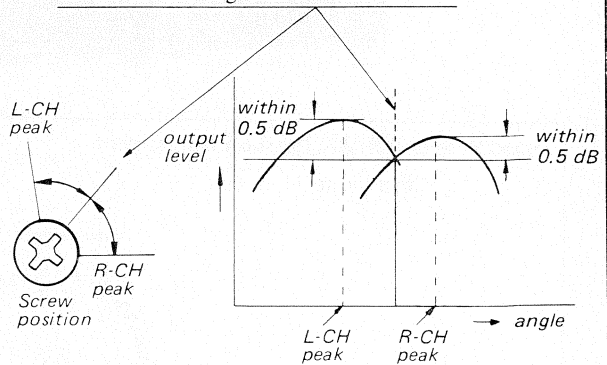

Adjustment Location:

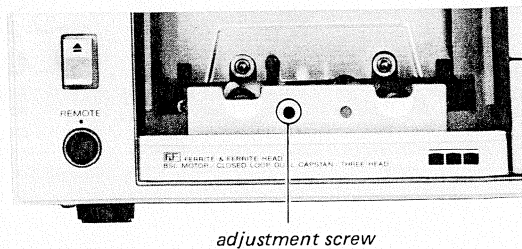

Tape Speed Adjustment

Procedure:

Mode: playback

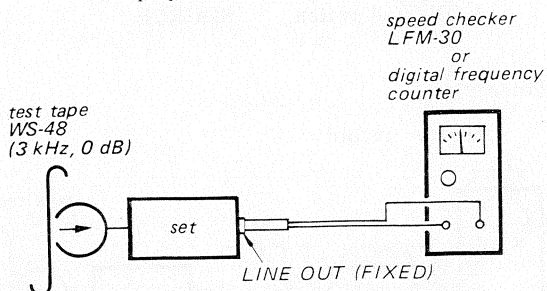

Specification:

Speed checker	Digital frequency counter
-0.7 to +0.7%	2,980 - 3,020 Hz

Frequency difference between the beginning and the end of the tape should be within 0.7% (20 Hz).

Adjustment Location:

- servo amp board -

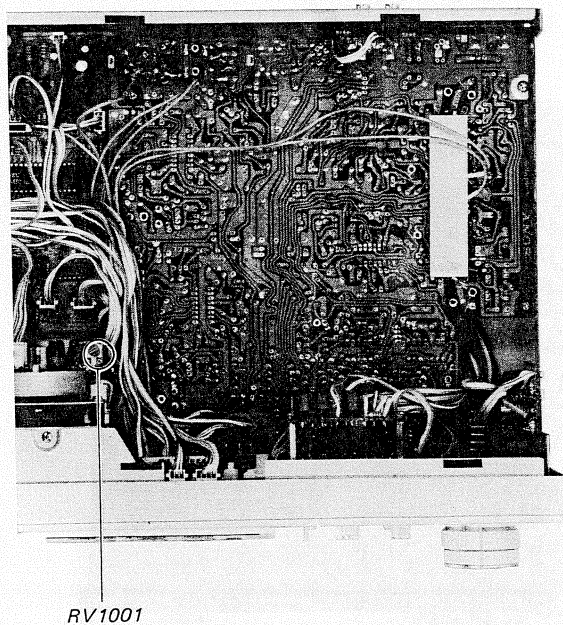

Playback Level Adjustment

Procedure:

Mode: playback

test tape
P-4-L81
(333 Hz, 0 dB)

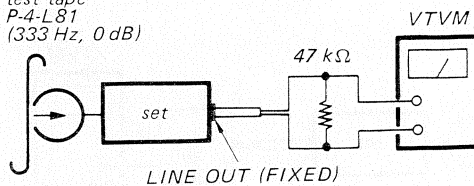

Specification:

LINE OUT level: 0.52 - 0.59 V
(-3.5 to -2.5 dB)

Level difference between channels:
less than 0.5 dB

Check that LINE OUT level does not change in playback mode while changing the mode from playback to stop several times.

Adjustment Location:

- record/playback board -

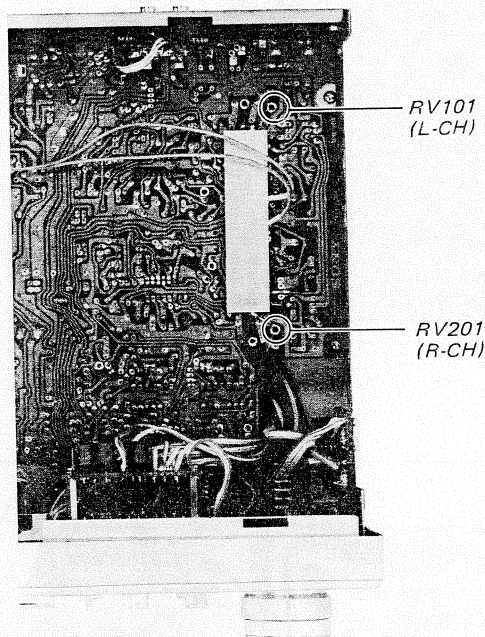

Bias Trap Adjustment

Procedure:

Mode: record (no-cassette loaded)

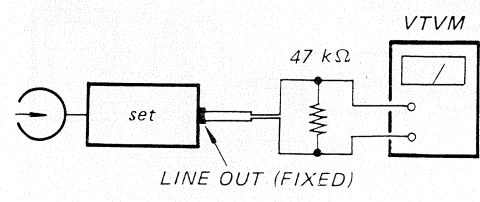

Specification:

LINE OUT level: less than 2.5 mV
(less than -50 dB)

Adjustment Location:

- record/playback board -

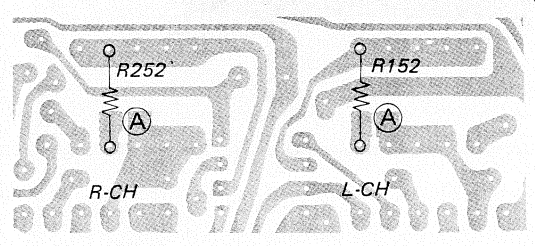
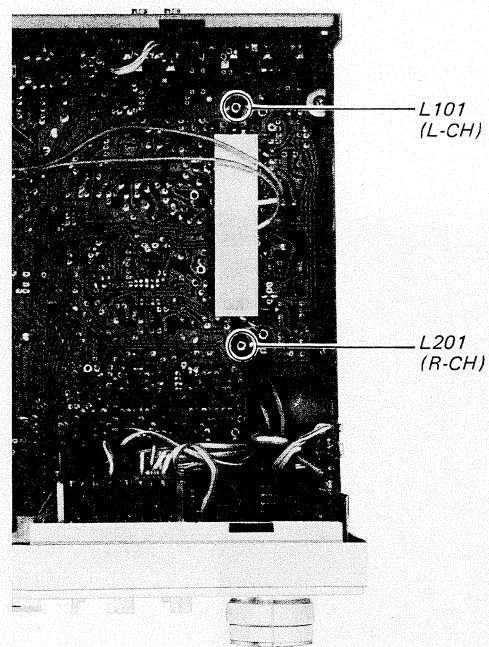

LED Peak Program Meter Calibration

- Setting:



REC LEVEL control: standard record
(See page 16.)

MONITOR switch: SOURCE

Procedure:

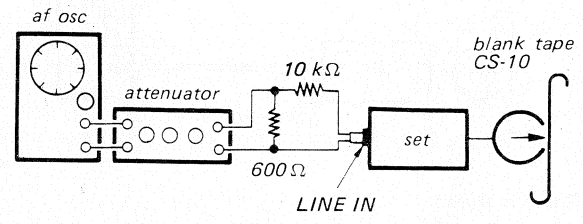
Mode: record



Slowly turn RV104 (L-CH) and RV204 (R-CH) and stop them just when the segments (  , -2 dB) go out.

Specification:

LINE IN level	Indication
0.85 - 1.1 V (+1 to +3 dB)	The first segment from the right lights.
2.7 - 5.5 mV (-49 to -43 dB)	The second segment from the left goes out.

If the second segment from the left does not go out when the 2.7 mV (-49 db) LINE IN signal is applied, solder (A).

Adjustment Location:

- record/playback board -

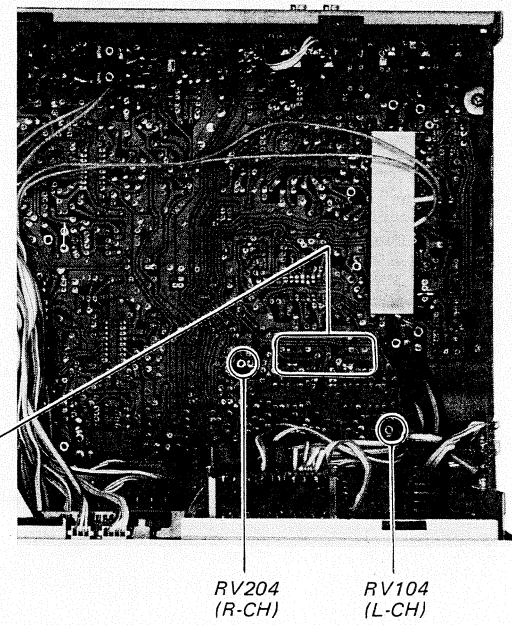

Record Bias Adjustment

Setting:
REC LEVEL control: standard record
(See page 16.)

Procedure:
1. Mode: record

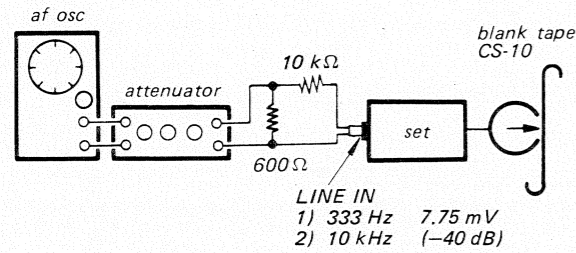

2. Mode: playback

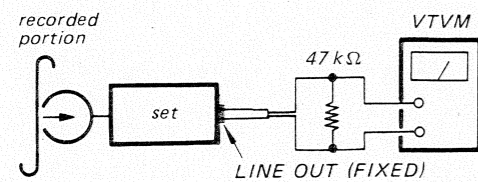

Adjust C154 (L-CH) and C254 (R-CH) so that the 333 Hz and the 10 kHz signal levels become the same.

Adjustment Location:
- record/playback board -

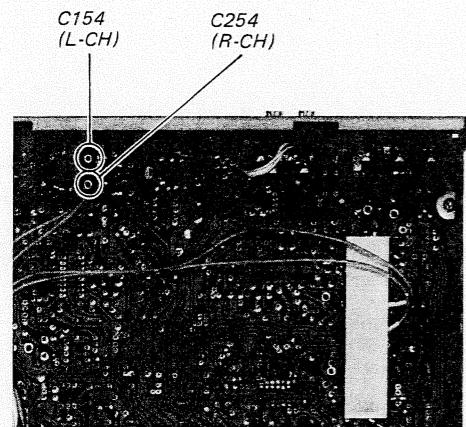

Record Level Adjustment

Setting:
REC LEVEL control: standard record
(See page 16.)

Procedure:
1. Mode: record

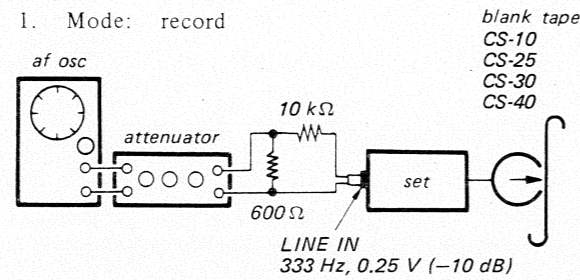

2. Mode: playback

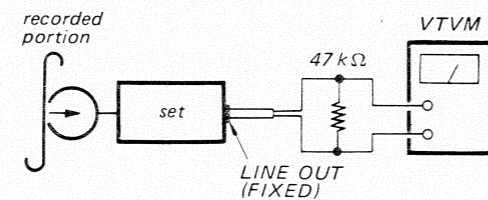

Specification:

Tape	LINE OUT level
CS-10	0.41 - 0.46 V (-5.5 to -4.5 dB)
CS-25 CS-30 CS-40	0.37 - 0.46 V (-6.5 to -4.5 dB)

Adjustment Location:
- record/playback board -

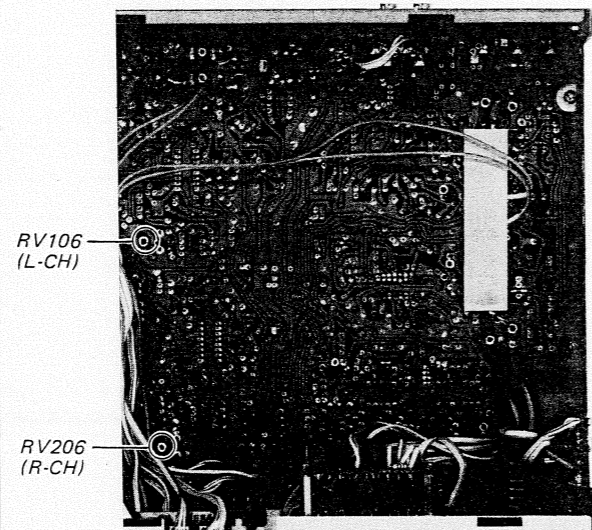

REC LEVEL CAL (calibration) Adjustment

Setting:
CALIBRATION switch: REC LEVEL

Procedure:
1. Mode: record
MONITOR switch: SOURCE

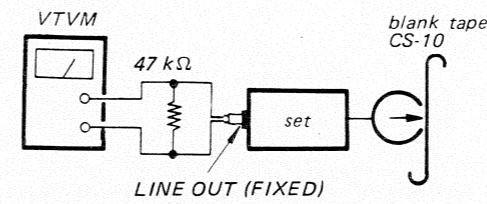

Confirm that the LINE OUT level is 43-45 mV (-25.2 to -24.8 dB).

2. Mode: record and simultaneous playback
MONITOR switch: TAPE

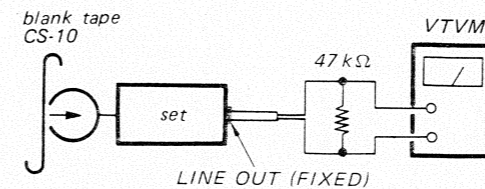

Confirm that the LINE OUT level is 42-47 mV (-25.5 to -24.5 dB).

3. Slowly turn RV102 (L-CH) and RV202 (R-CH) and stop them just when the second RED segments go out.

4. Confirm that the LINE OUT levels vary between 29-66 mV (-28.5 to -21.5 dB) according to the REC LEVEL CAL controls turning.

Adjustment Location:
- record/playback board -

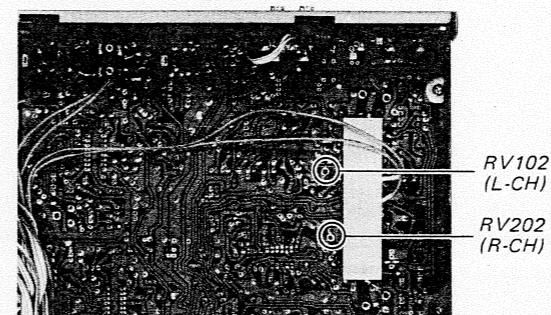

BIAS CAL (calibration) Measurement

-Setting:
CALIBRATION switch: BIAS

Procedure:
1. Mode: record and simultaneous playback
MONITOR switch: TAPE

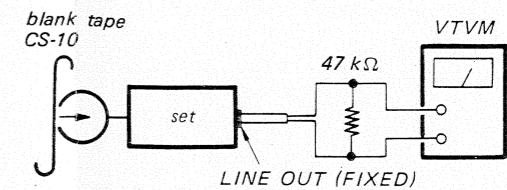

2. Confirm that the LINE OUT level is 42-47 mV (-25.5 to -24.5 dB).

3. Confirm that the LED peak program meter indicates approx. 0 dB, and the LINE OUT levels vary between 25-77mV (-30 to -20dB) according to the REC LEVEL CAL controls turning.

SECTION 4
DIAGRAMS

REC LEVEL CAL (calibration) Adjustment

Setting:

CALIBRATION switch: REC LEVEL

Procedure:

1. Mode: record
MONITOR switch: SOURCE

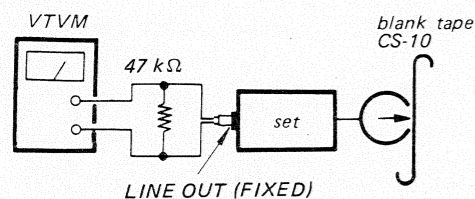

Confirm that the LINE OUT level is 43–45 mV (–25.2 to –24.8 dB).

2. Mode: record and simultaneous playback
MONITOR switch: TAPE

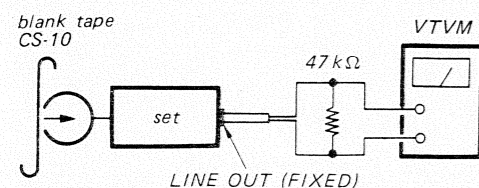

Confirm that the LINE OUT level is 42–47 mV (–25.5 to –24.5 dB).

3. Slowly turn RV102 (L-CH) and RV202 (R-CH) and stop them just when the second RED segments go out.

4. Confirm that the LINE OUT levels vary between 29–66 mV (–28.5 to –21.5 dB) according to the REC LEVEL CAL controls turning.

Adjustment Location

– record/playback board –

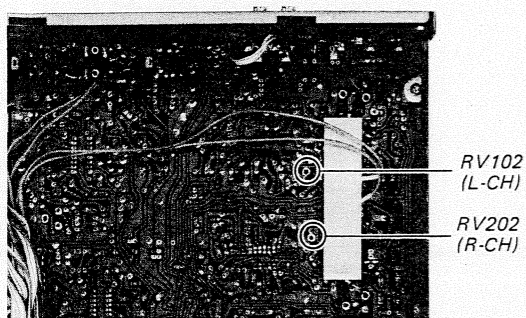

BIAS CAL (calibration) Measurement

Setting:

CALIBRATION switch: BIAS

Procedure:

1. Mode: record and simultaneous playback
MONITOR switch: TAPE

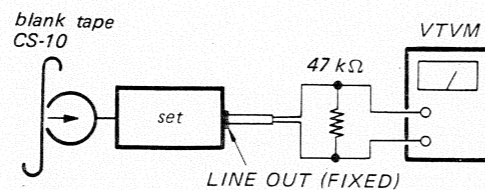

2. Confirm that the LINE OUT level is 42–47 mV (–25.5 to –24.5 dB).

3. Confirm that the LED peak program meter indicates approx. 0 dB, and the LINE OUT levels vary between 25–77mV (–30 to –20dB) according to the REC LEVEL CAL controls turning.

Voltages and Waveforms at the Terminals of IC801.

Terminal No.	Waveform or Voltage	Terminal No.	Waveform or Voltage	Terminal No.	Waveform or Voltage
①		⑭	Forward Mode 	⑲	10 Vdc
②	• Forward Mode • Fast Forward Mode 	⑮	Record Mode 	⑳	Fast Forward Mode
③		⑯	10 Vdc	㉑	Rewind Mode
④ to ⑥	0 Vdc	⑰	Forward Mode 	㉒	10 Vdc
⑦		⑱	Pause Mode 	㉓	10 Vdc
⑧		㉔	0 Vdc	㉕	Record/Forward button is pushed. Record Muting or Pause button is pushed.
⑨		㉖	Forward or Record Mode 	㉗	10 Vdc
⑩		㉘	Fast Forward or Rewind Mode or Record/Forward/Pause Mode 	㉙	0 Vdc
⑪	0 Vdc	㉚	Forward Mode 	㉛	• S810 (MEMORY): ON
⑫ ⑬	Fast Forward or Rewind Mode 	㉜	Forward or Fast Forward or Rewind button is pushed. 	㉜	• S811 (timer): PLAY
				㉝	• S811 (timer): REC
				㉞	When the accidental erasure prevention tab is broken: 0V When the accidental erasure prevention tab is not broken: 10V
				㉟	0 Vdc
				㊱	

4-1. SCHEMATIC DIAGRAM — System Control Section —

Refer to page 21 for voltages and waveforms at the terminals of IC801.

- Note:**
- All capacitors are in μF unless otherwise noted. p : μF 50WV or less are not indicated except for electrolytics.
 - All resistors are in ohms, 1/4W unless otherwise noted. k Ω : 1000 Ω , M Ω : 1000k Ω
 - : fusible resistor
 - : nonflammable resistor.
 - 1% indicates component tolerance.
 - : B+ bus.
 - : B- bus.
 - : panel designation.
 - : adjustment for repair.
 - Voltages are dc with respect to ground unless otherwise noted.
 - Readings are taken with a VOM (20 k Ω /V).
- no mark : STOP
- : FORWARD
 - : FAST FORWARD
 - : REWIND
 - : RECORD
 - : REC MUTE
 - : PAUSE
 - : STOP

Voltage variations may be noted due to normal production tolerances.

Switch

Ref. No.	Switch	Position
S801	POWER	OFF
S802	REWIND	OFF
S803	STOP	OFF
S804	FORWARD	OFF
S805	FAST FORWARD	OFF
S806	RECORD	OFF
S807	PAUSE	OFF
S808	REC MUTE	OFF
S812	ACCIDENTAL-ERASURE PREVENTION	ON
S813	CASSETTE	OFF

Note: The components identified by shading and mark are critical for safety. Replace only with part number specified.

Note: Les composants identifiés par un trame et une marque sont critiques pour la sécurité. Ne les remplacer que par une pièce portant le numéro spécifié.

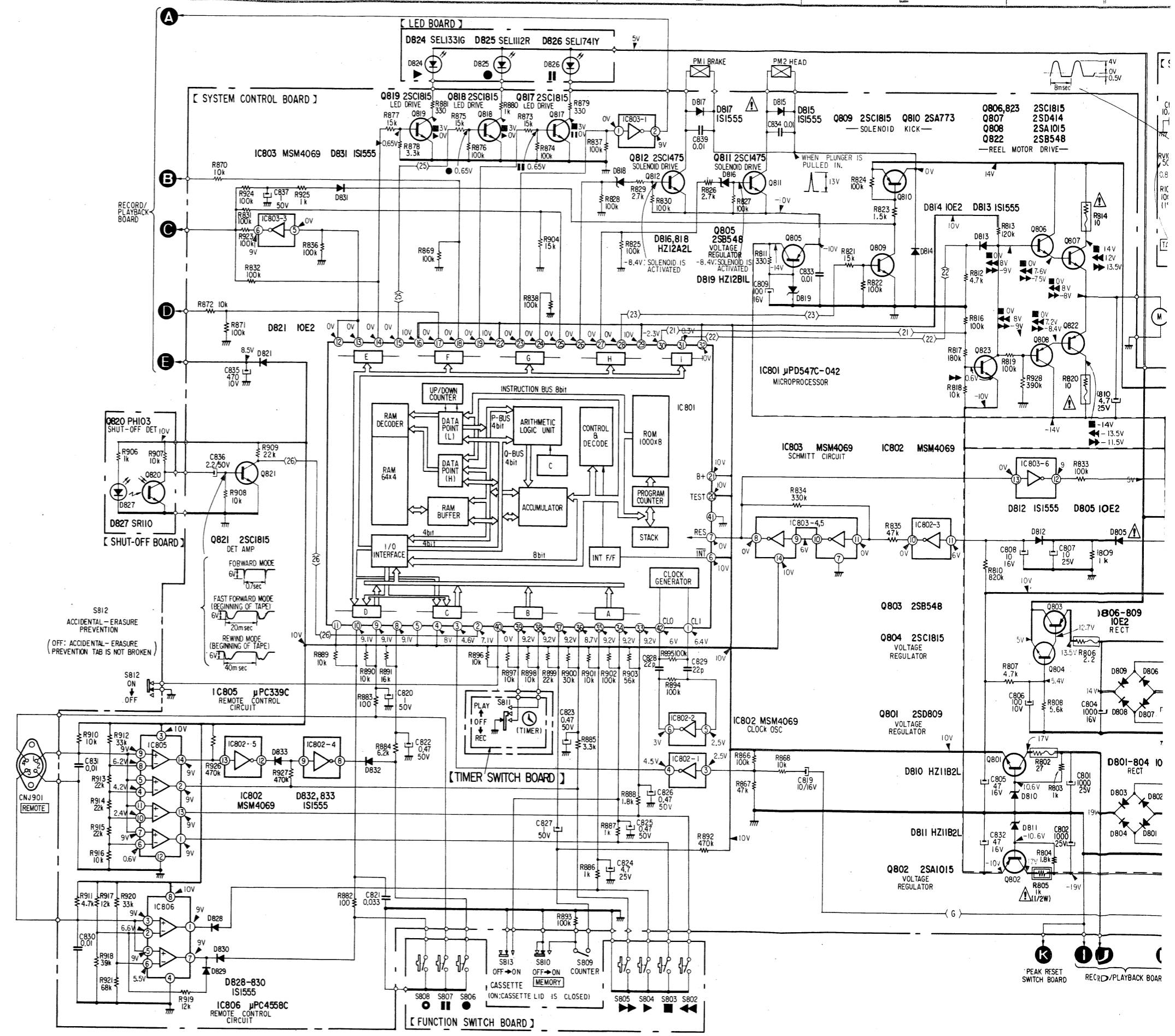

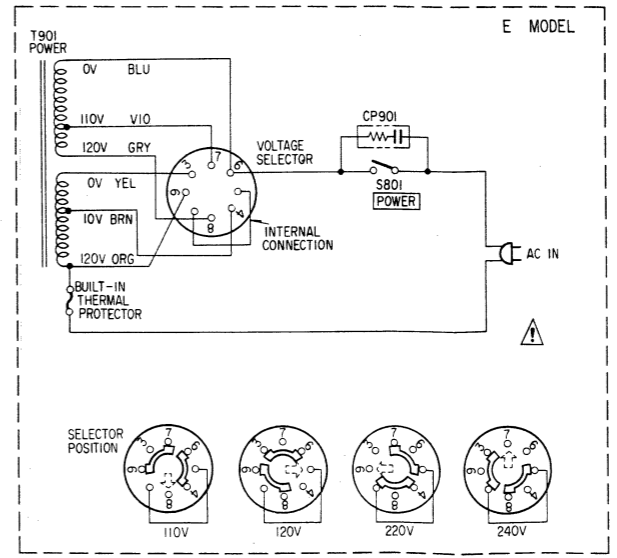
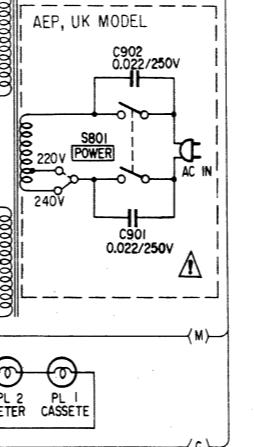
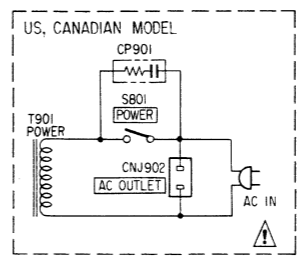
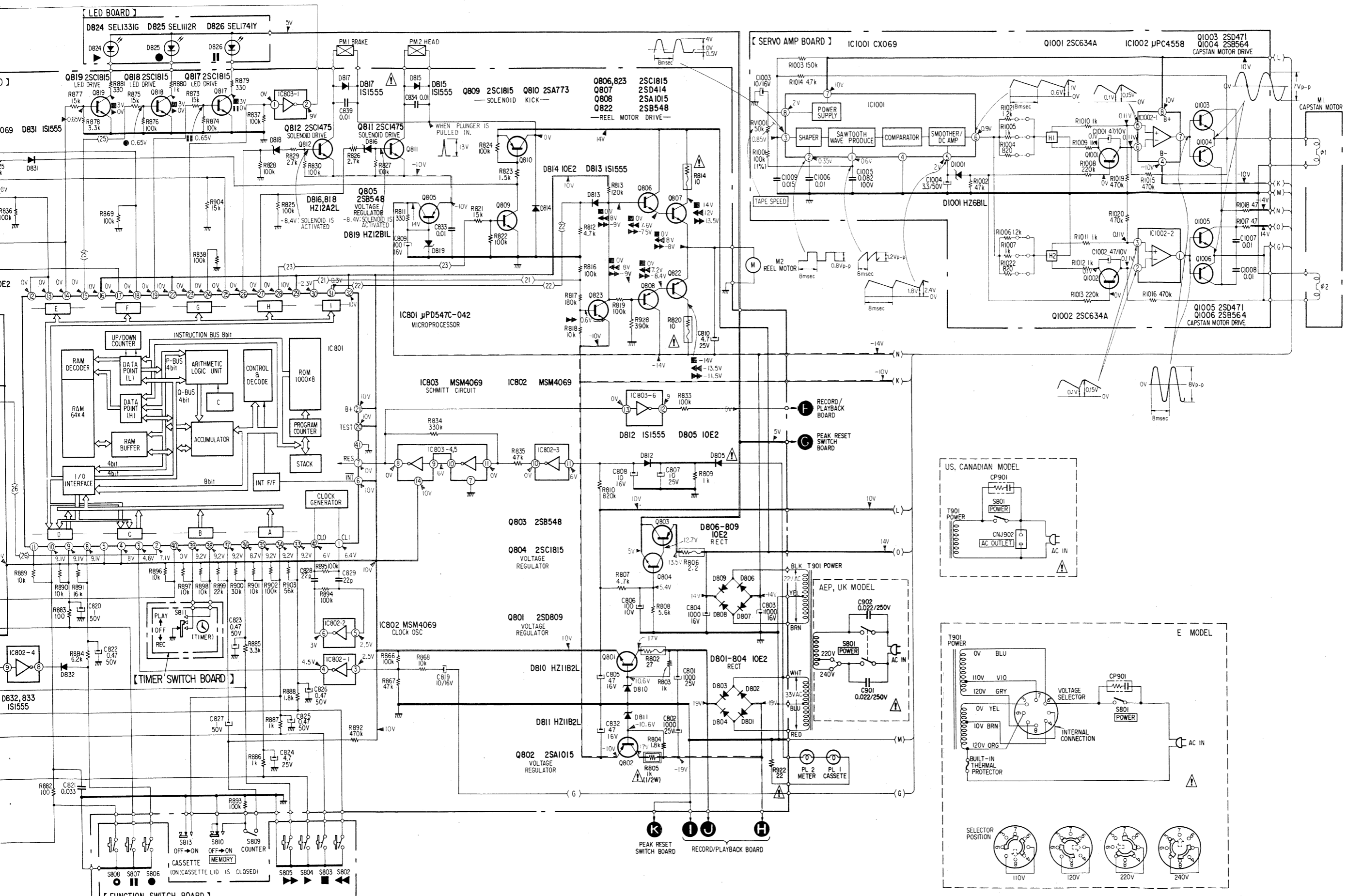

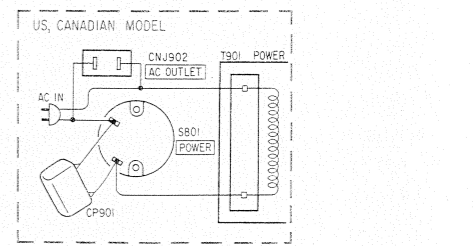
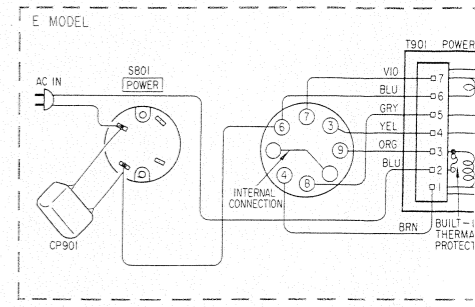
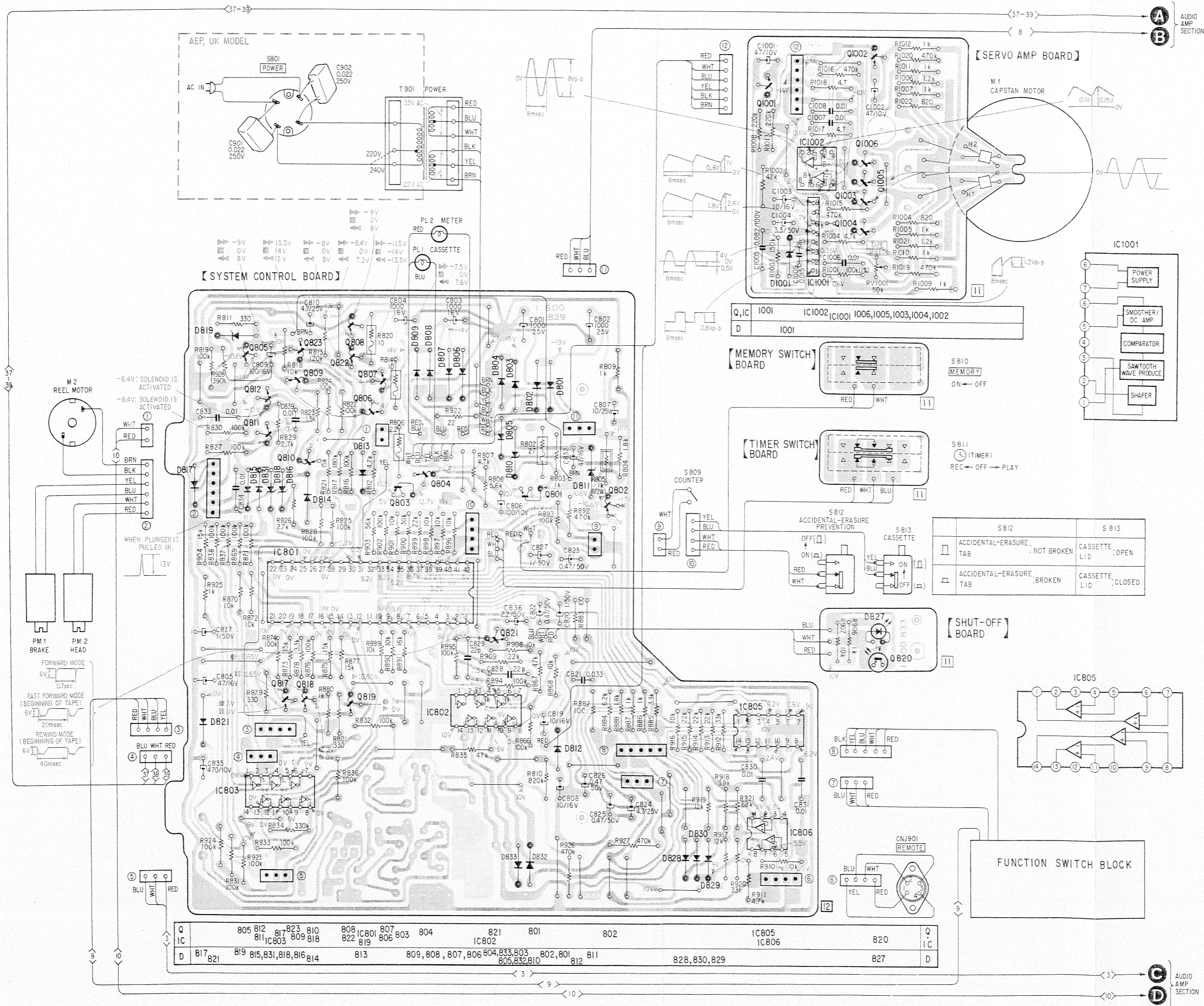

Refer to page 21 for voltages and wave at the terminal of IC801.

Note:
• Color code of sleeving over the end of the ja

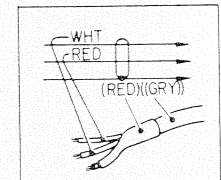

- : B+ pattern.
- : B- pattern.
- no mark: STOP
- : FORWARD
- : FAST FORWARD
- : REWIND
- : RECORD
- : REC MUTE
- : PAUSE
- : STOP

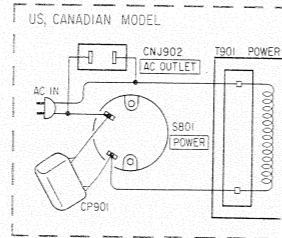
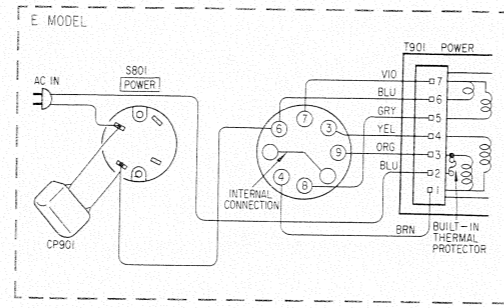
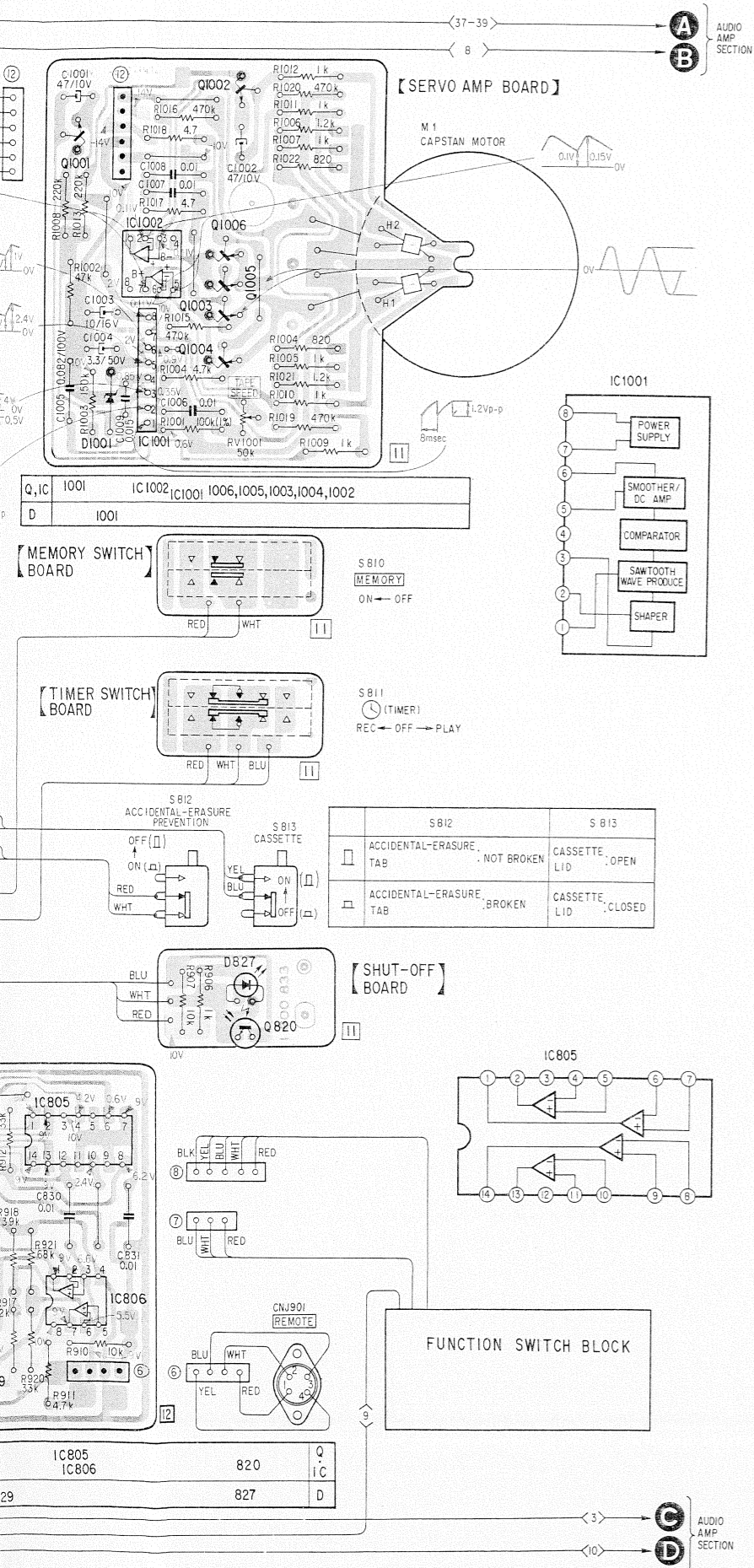

Refer to page 21 for voltages and waveforms at the terminal of IC801.

Note:

- Color code of sleeving over the end of the jacket.

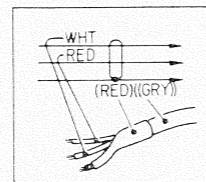

- : B+ pattern.
- : B- pattern.
- no mark: STOP
- : FORWARD
- : FAST FORWARD
- : REWIND
- : RECORD
- : REC MUTE
- : PAUSE
- : STOP

Replacement Semiconductors

For replacement, use semiconductors except in ().

Q801: 2SD809

Q807: 2SD414

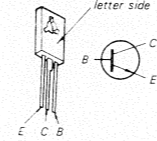

Q1001, 1002: 2SC1364

(2SC634A)

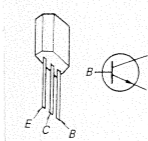
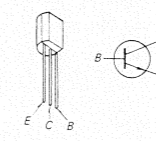

- D801-805 : 10E2
- 806-809 : 10E2
- 814, 821 : 10E2
- D812, 813 : 1S1555
- 815, 817 : 1S1555
- 828-833 : 1S1555



Q802, 808: 2SA1027R (2SA1015)

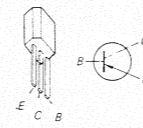

Q1003, 1005: 2SC1475

(2SD471)

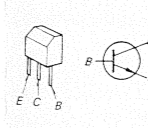
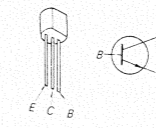

Q803, 805, 822: 2SB548

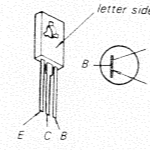

Q1004, 1006: 2SA684

(2SB564)

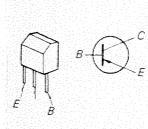
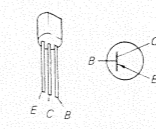

- D810, 811: HZ11B2L
- D816, 818: HZ12A3L (HZ12A2L)
- D819: HZ12B2L (HZ12B1L)

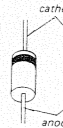

Q804, 806

809, 817-819 : 2SC1364

(2SC1815)

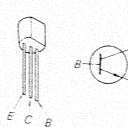
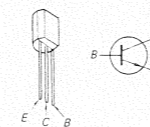

IC801: μ PD547C-042

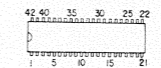

(Top view)

D824: SEL1331G

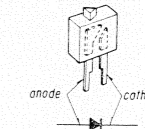

Q810: 2SA684 (2SA773)

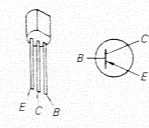

IC802, 803: MSM4069

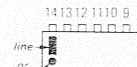

(Top view)

D825: SEL1112R

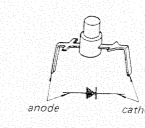

Q811, 812 : 2SC1475

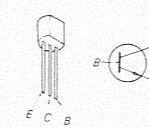

IC805: μ PC339C

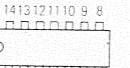

(Top view)

D826: SEL1741Y

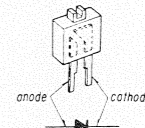

Q820: PH103

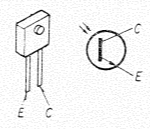

IC806: μ PC4558C

IC1002: μ PC4558C (μ PC4558)

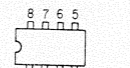

(Top view)

D827: SR110

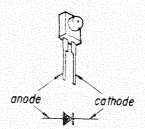

IC1001: CX069

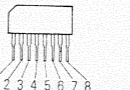

- Color code of sleeving over the end of the jacket.

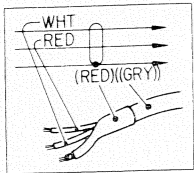

- B + pattern
- B - pattern
- Signal path
 - L-CH
 - R-CH
 - Common
- no mark: STOP
- FORWARD
- FAST FORWARD
- REWIND
- RECORD
- REC MUTE
- PAUSE
- STOP

SYSTEM CONTROL SECTION

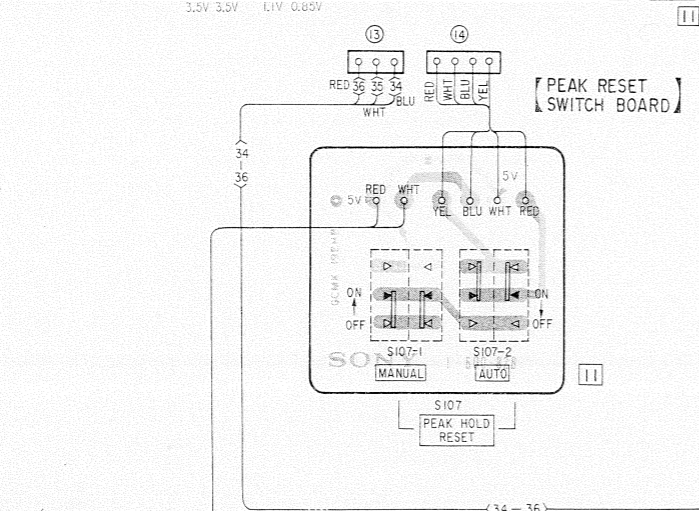
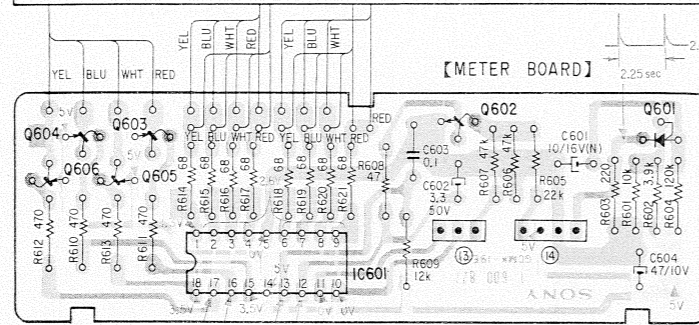
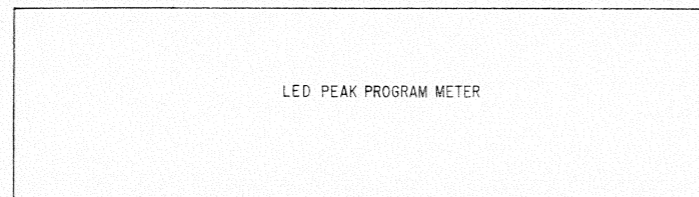
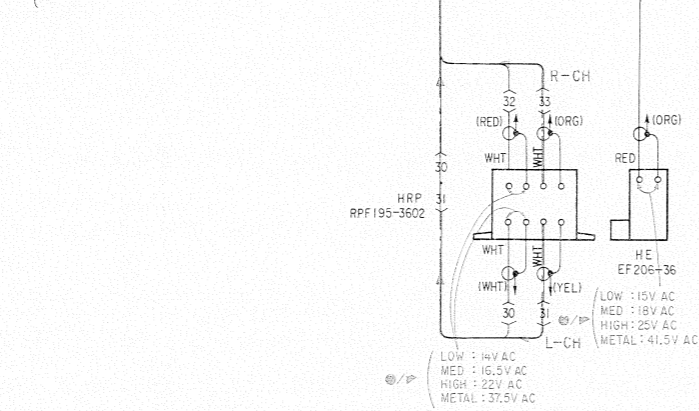

SYSTEM CONTROL SECTION

Q, IC	D
509	503
510,504	
501,502	
503	
511	501
508	
512	
505	
507	
506	106
IC104	502
515	
IC103	
102	
101	
110	101
109	
204	
201	
202	
203	
IC201	
201	
211	
IC204	
206	515
202,203	
102,103	
206	
IC103	
106	
209,208,207	
205,108	
210,105	
107	
512	
205	
505,504	
509	
105	
507	
516	
IC102	
514	
518	
IC501	
513	
Q, IC	D

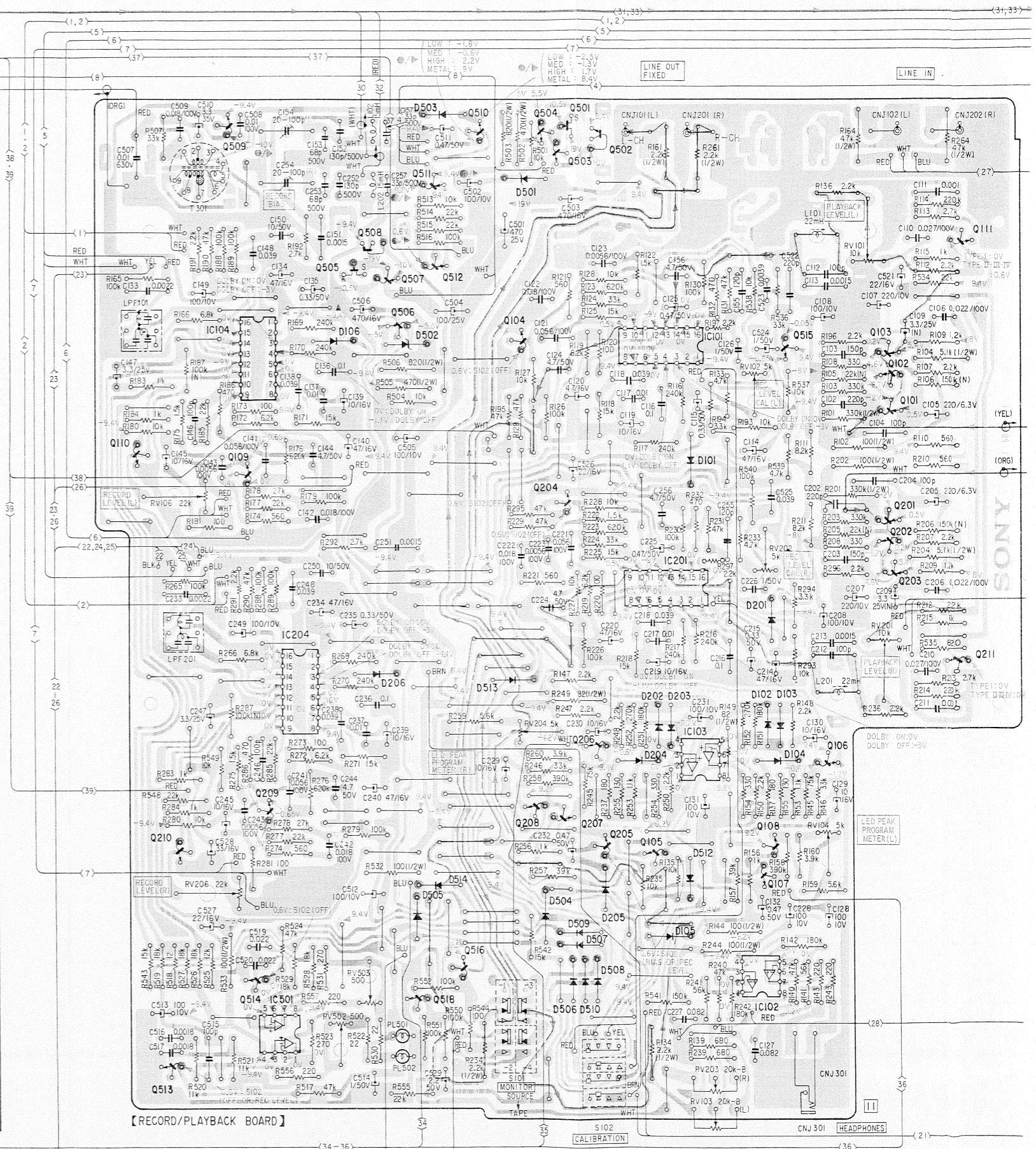

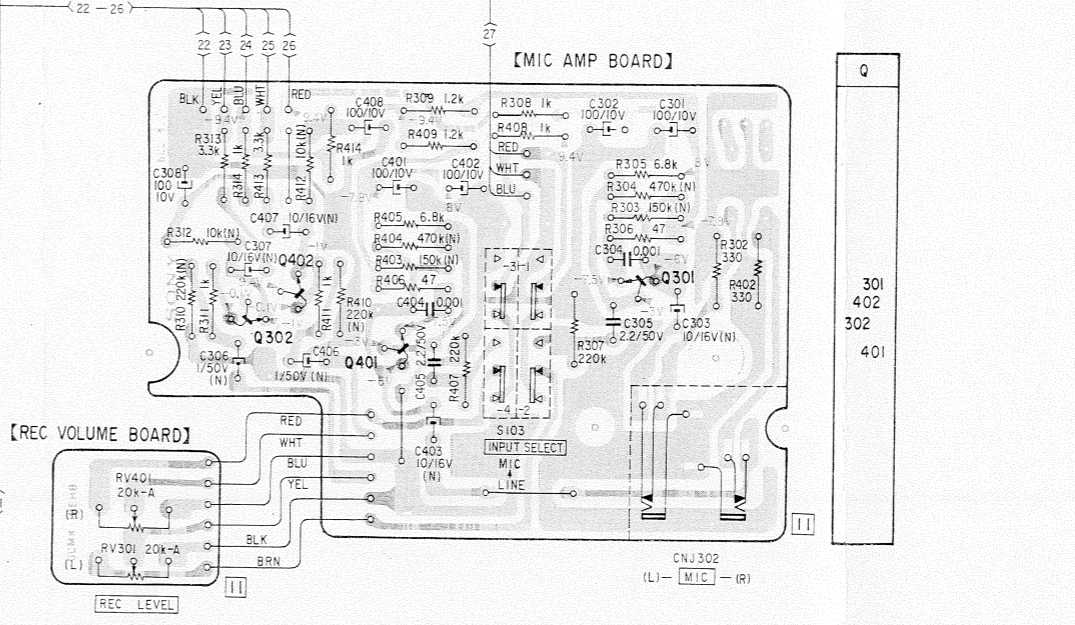
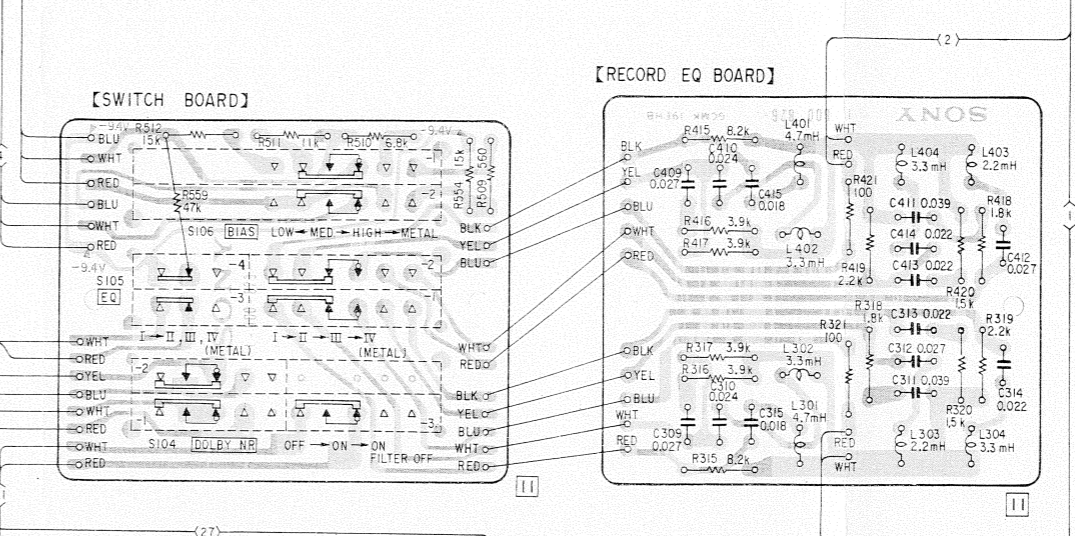
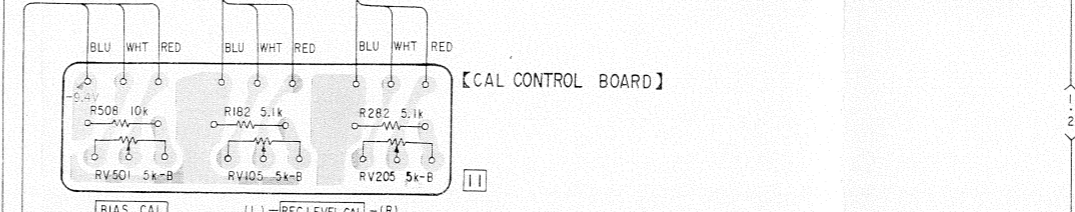
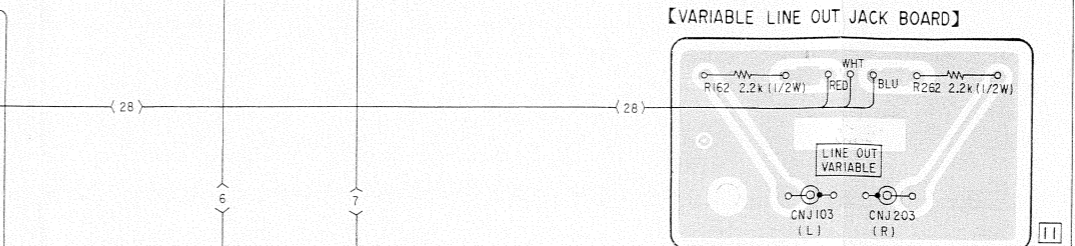
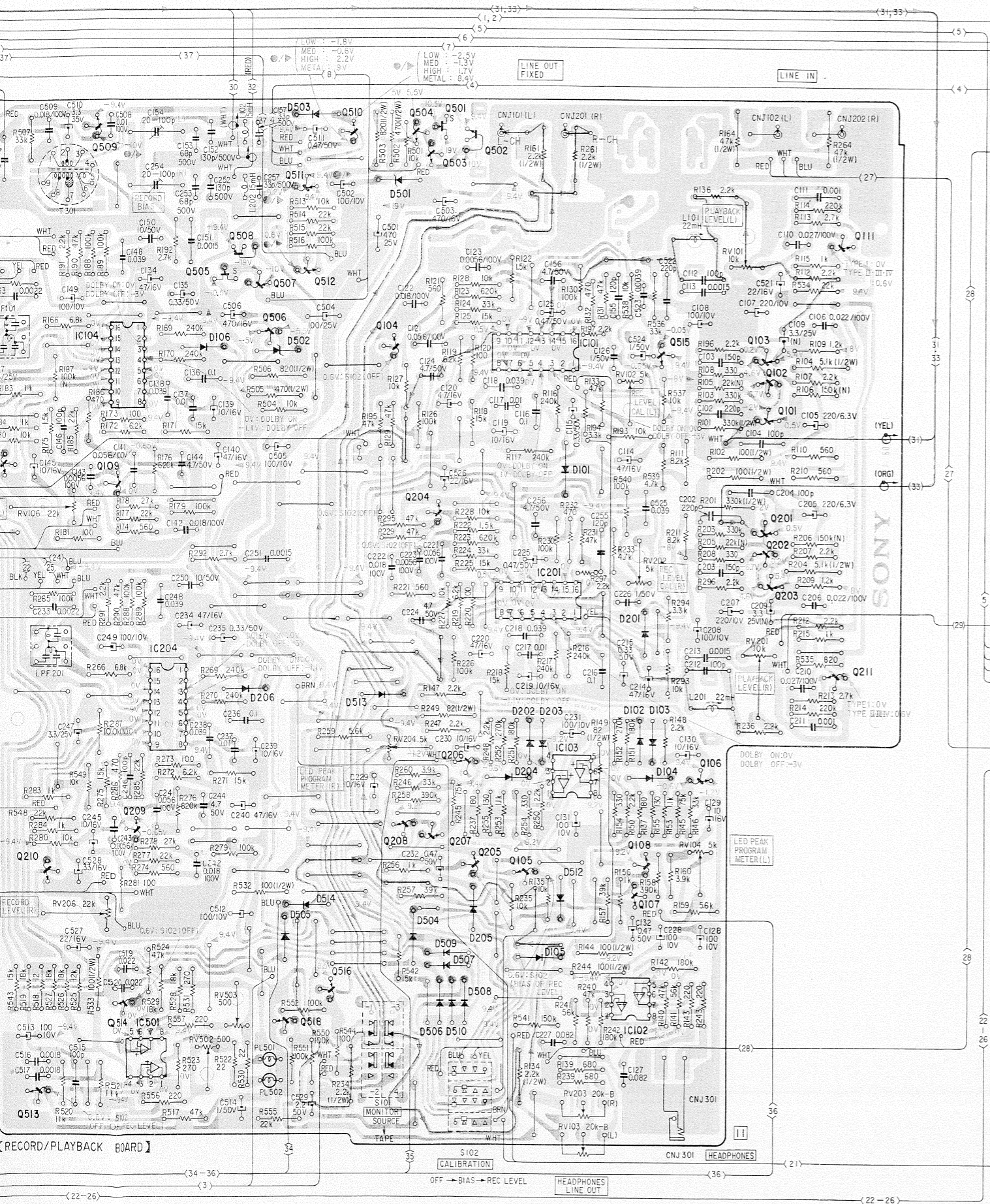

[RECORD/PLAYBACK BOARD]

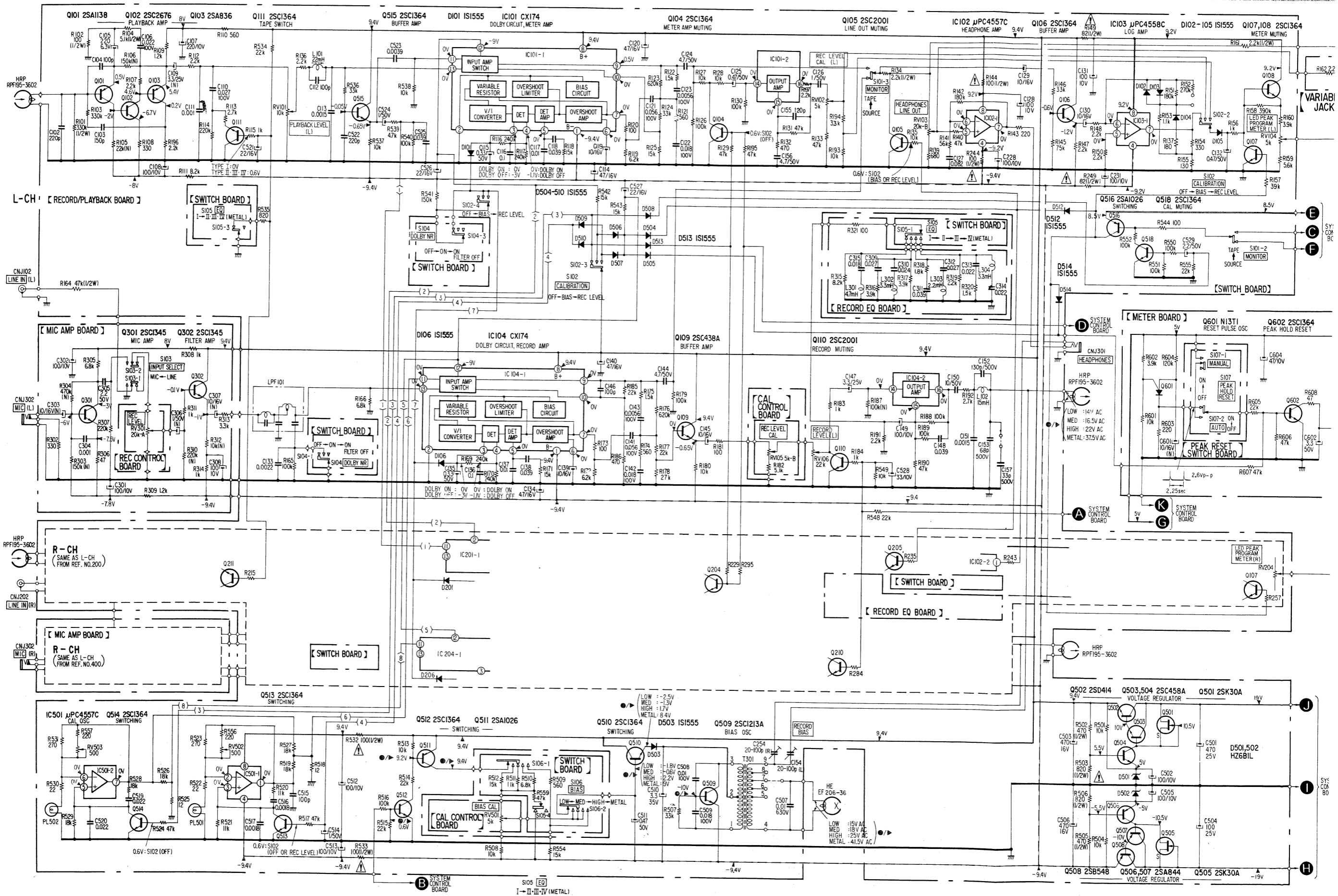

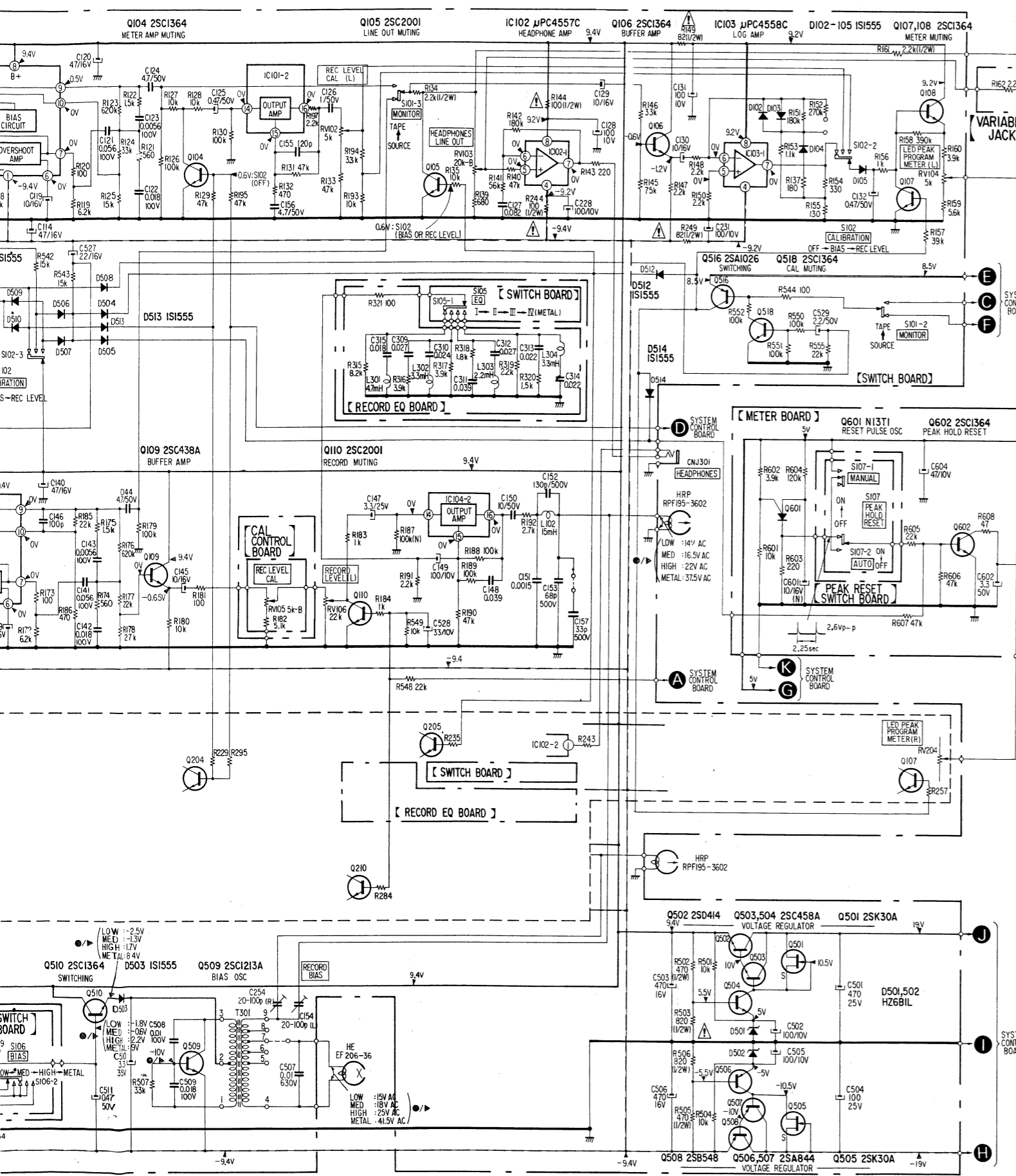







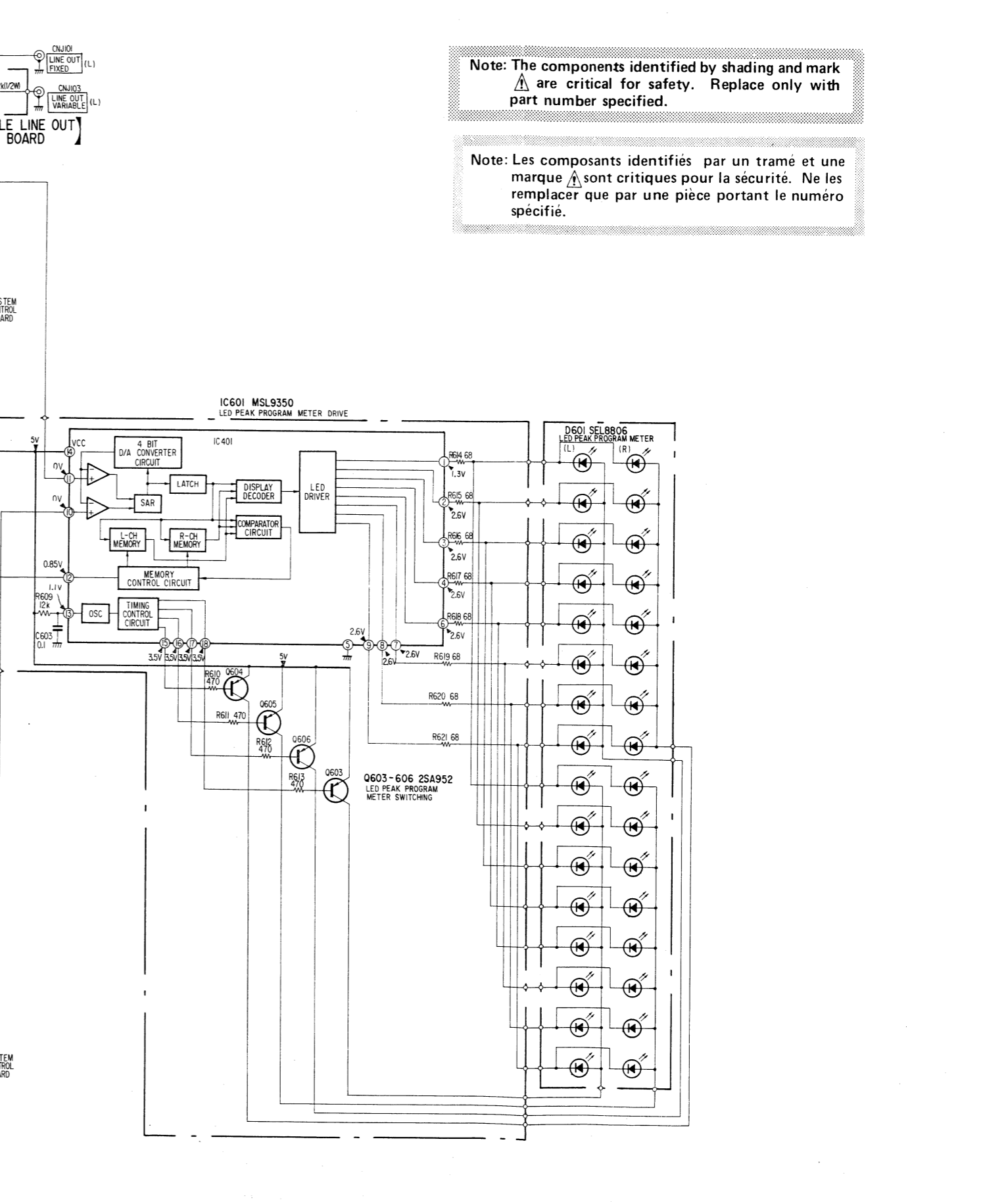

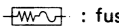
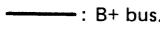
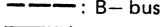
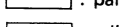
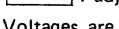

Note: The components identified by shading and mark  are critical for safety. Replace only with part number specified.

Note: Les composants identifiés par un trame et une marque  sont critiques pour la sécurité. Ne les remplacer que par une pièce portant le numéro spécifié.



— Audio Amp Section —

Note:

- Components for right channel have same values as for left channel. Reference numbers are coded from 200 and 400.
- All capacitors are in μF unless otherwise noted. $\text{pF} = \mu\mu\text{F}$ 50WV or less are not indicated except for electrolytics.
- All resistors are in ohms, $\frac{1}{4}\text{W}$ unless otherwise noted. $\text{k}\Omega : 1000 \Omega$, $\text{M}\Omega = 1000 \text{k}\Omega$
-  : fusible resistor.
- (N) : low-noise.
-  : B+ bus.
-  : B- bus.
-  : panel designation.
-  : adjustment for repair.
- Voltages are dc with respect to ground unless otherwise noted.
- Readings are taken under no signal conditions with a VOM (20 $\text{k}\Omega/\text{V}$).
- no mark: STOP
-  : FORWARD
-  : FAST FORWARD
-  : REWIND
-  : RECORD
-  : REC MUTE
-  : PAUSE
-  : STOP
- AC voltage readings in the bias oscillator circuit are taken with a VTVM.
- Voltage variations may be noted due to normal production tolerances.

Ref. No.	Switch	Position
S101-1 to 101-4	MONITOR	TAPE
S102-1 to 101-4	CALIBRATION	OFF
S103-1 to 103-4	INPUT SELECT	LINE
S104-1 to 104-3	DOLBY NR	OFF
S105-1 to 105-4	EQ	I
S106-1, 2	BIAS	MED
S107-1	MANUAL	OFF
S107-2	AUTO	ON

IC101, 104, 201, 204

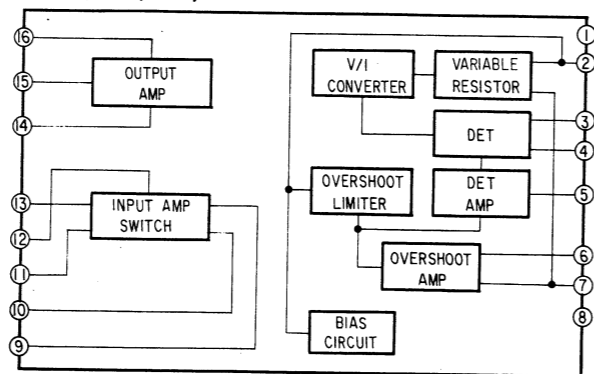

IC601

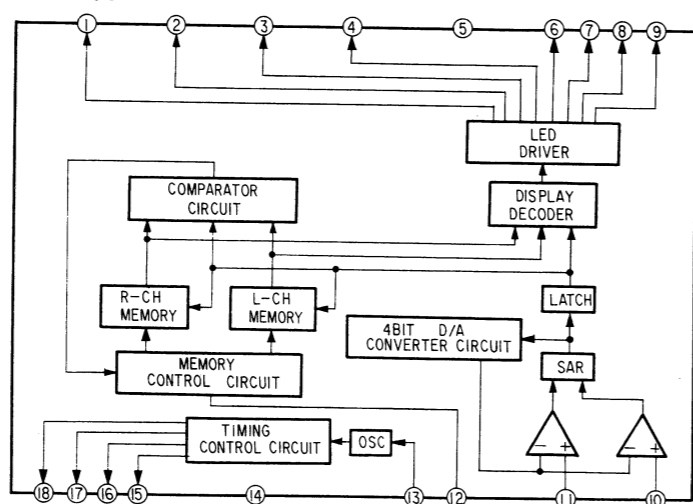

— Audio Amp Section —

• Replacement Semiconductors

For replacement, use semiconductors except in ().

Q101, 201 : 2SA1138

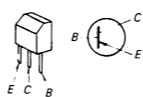

Q102, 202 : 2SC2676

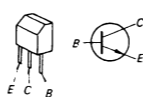

Q103, 203 : 2SA872-E (2SA836)

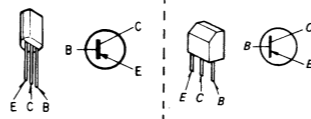

Q104, 204 }
Q106-108 } : 2SC1364
Q206-208 }
Q111, 211 }
510, 512-515 }
518, 602 }

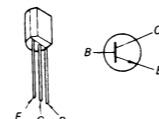

Q105, 205 }
Q110, 210 } : 2SC2001
Q301, 401 }
Q302, 402 } : 2SC1345

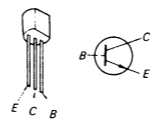

Q109, 209 }
Q503, 504 } : 2SC1362 (2SC458A)

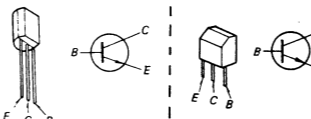

Q501, 505 : 2SK30A

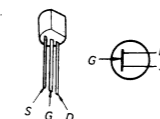

Q502 : 2SD414

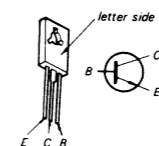

Q506, 507 : 2SA1027R (2SA844)
Q511, 516 : 2SA1027R (2SA1026)

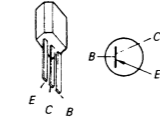

Q508 : 2SB548

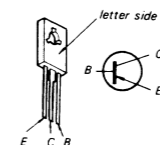

Q509 : 2SC1475 (2SC1213A)

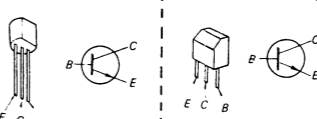

Q601 : N13T1

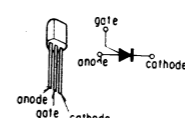

Q603-606 : 2SA952

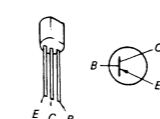

IC101, 201 }
IC104, 204 } : CX174

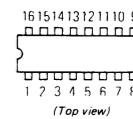

IC102, 202 } : $\mu\text{PC}4557\text{C}$
IC501 }
IC103, 203 : $\mu\text{PC}4558\text{C}$

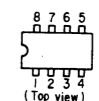

IC601 : MSL9350

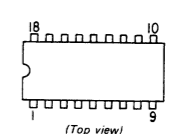

D101-106 }
201-206 } : 1S1555
503-510 }
512-514 }

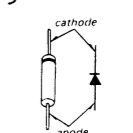

D501, 502 : HZ6B2L (HZ6B1L)

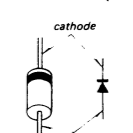

E
D
C
B
A

SECTION 5
EXPLODED VIEWS

— Audio Amp Section —

• Replacement Semiconductors

For replacement, use semiconductors except in ().

Q101, 201 : 2SA1138

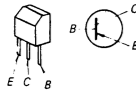

Q102, 202 : 2SC2676

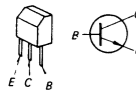

Q103, 203 : 2SA872-E

(2SA836)

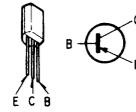

Q104, 204 }
Q106—108 } : 2SC1364
Q206—208 }
Q111, 211 }
510, 512—515 }
518, 602 }

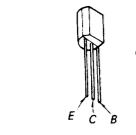

Q105, 205 } : 2SC2001
Q110, 210 }
Q301, 401 } : 2SC1345
Q302, 402 }

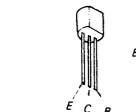

Q109, 209 } : 2SC1362
Q503, 504 }

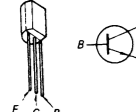

(2SC458A)

Q501, 505 : 2SK30A

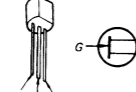

Q502 : 2SD414

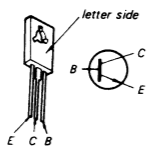

Q506, 507 : 2SA1027R (2SA844)
Q511, 516 : 2SA1027R (2SA1026)

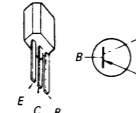

Q508 : 2SB548

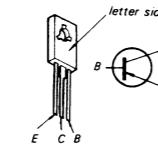

Q509 : 2SC1475

(2SC1213A)

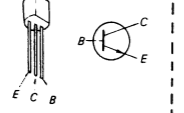

Q601 : N13TI

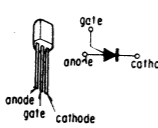

Q603—606 : 2SA952

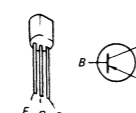

IC101, 201 } : CX174
IC104, 204 }

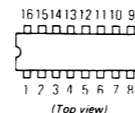

IC102, 202 } : μPC4557C
IC501 }
IC103, 203 : μPC4558C

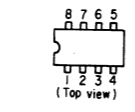

IC601 : MSL9350

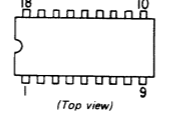

D101—106 } : 1S1555
201—206 }
503—510 }
512—514 }

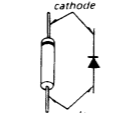

D501, 502 : HZ6B2L (HZ6B1L)

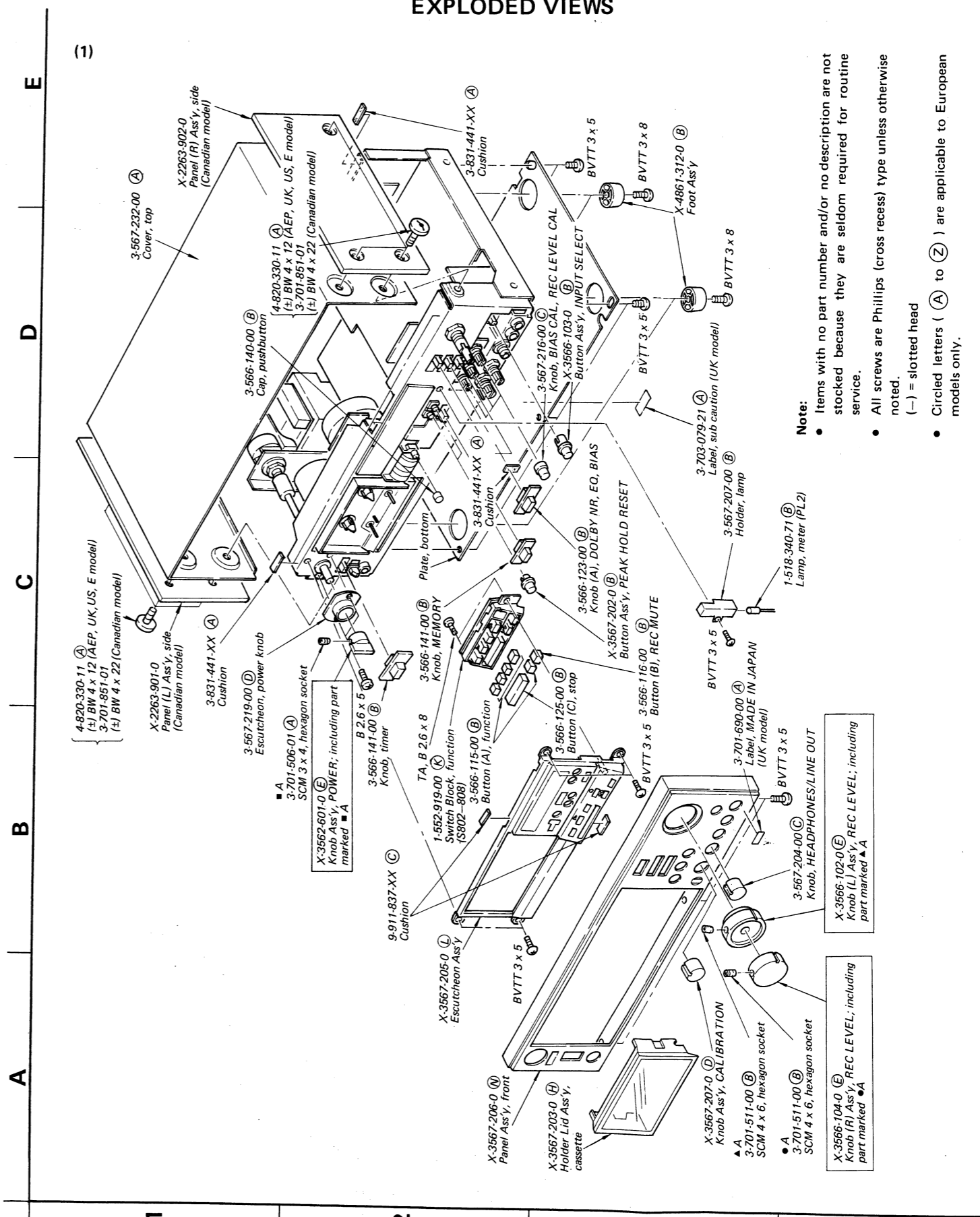
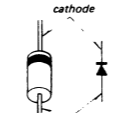

Note:
• Items with no part number and/or no description are not stocked because they are seldom required for routine service.
• All screws are Phillips (cross recess) type unless otherwise noted.
• Circled letters (A) to (Z) are applicable to European models only.

A B C D E

Note:

- Items with no part number and/or no description are not stocked because they are seldom required for routine service.
- All screws are Phillips (cross recess) type unless otherwise noted.
(-) = slotted head
- Circled letters (A to Z) are applicable to European models only.

(2)

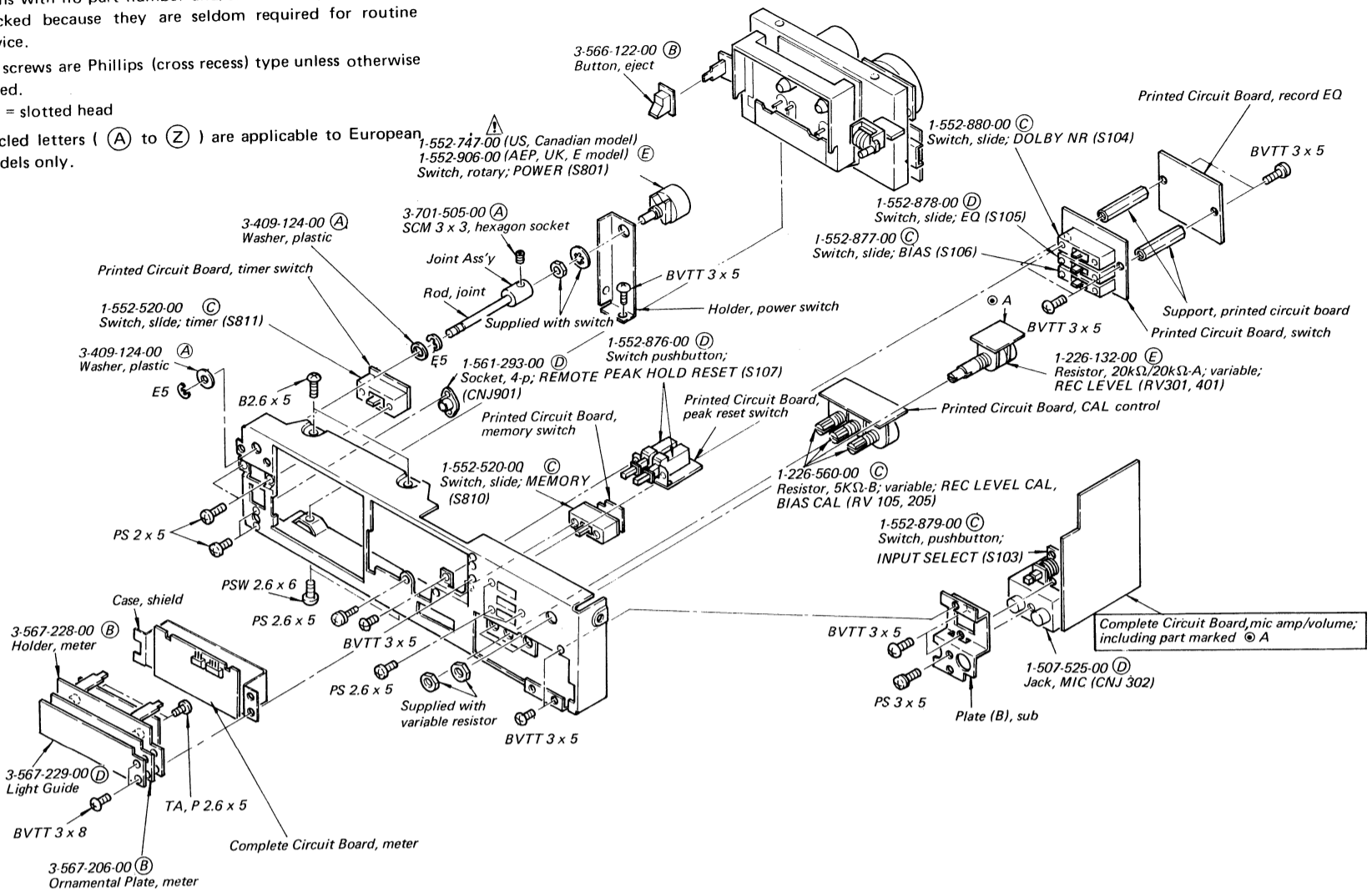

Note: The components identified by shading and mark are critical for safety. Replace only with part number specified.

Note: Les composants identifiés par un trame et une marque sont critiques pour la sécurité. Ne les remplacer que par une pièce portant le numéro spécifié.

A B C D E

- Items with no part number and/or no description are not stocked because they are seldom required for routine service.
- All screws are Phillips (cross recess) type unless otherwise noted.
(-) = slotted head
- Circled letters (A to Z) are applicable to European models only.

(3)

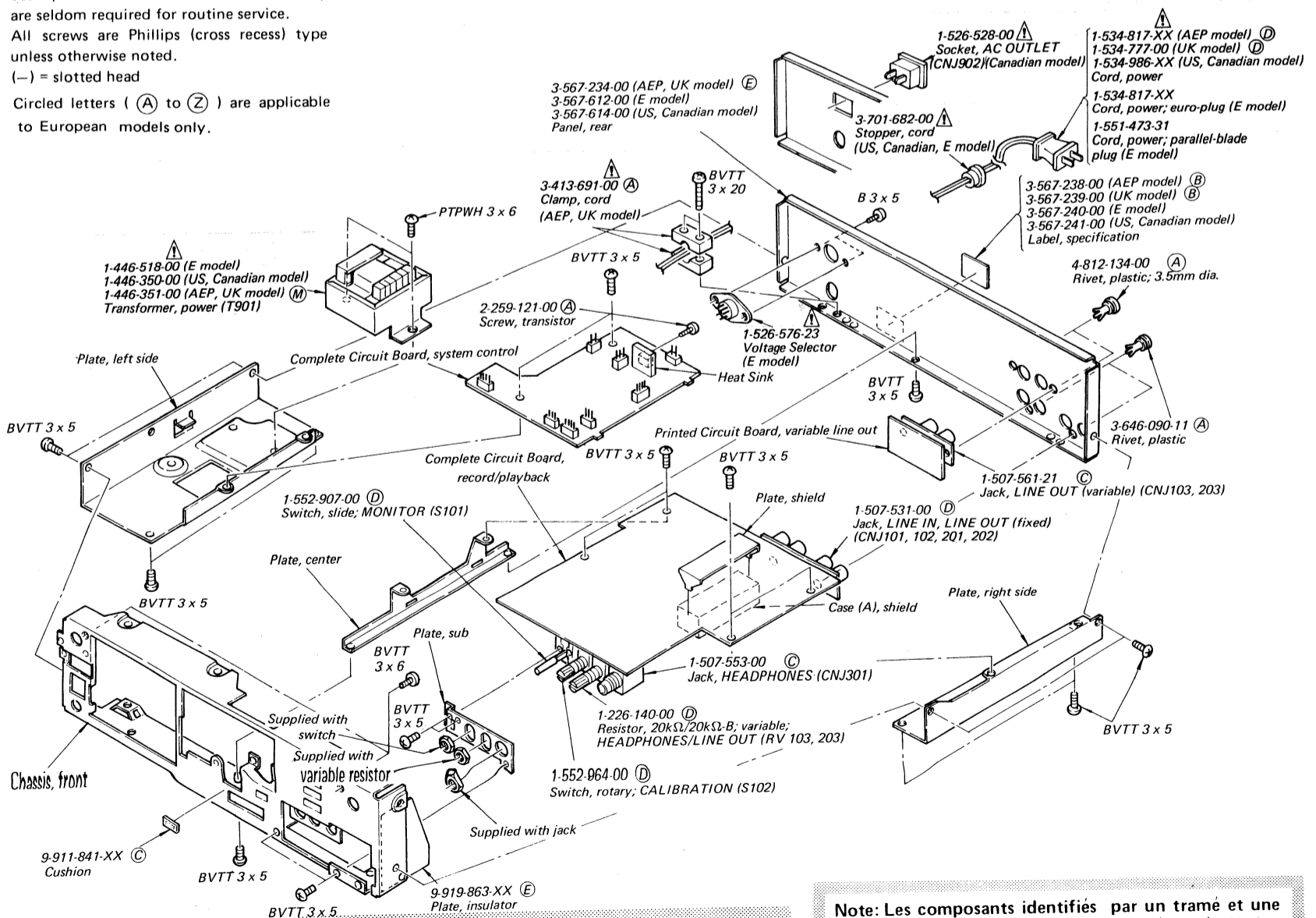

Note: The components identified by shading and mark are critical for safety. Replace only with part number specified.

Note: Les composants identifiés par un trame et une marque sont critiques pour la sécurité. Ne les remplacer que par une pièce portant le numéro spécifié.

TC-K75 TC-K75

1

2

- 37 -

3

4

1

2

- 38 -

3

4

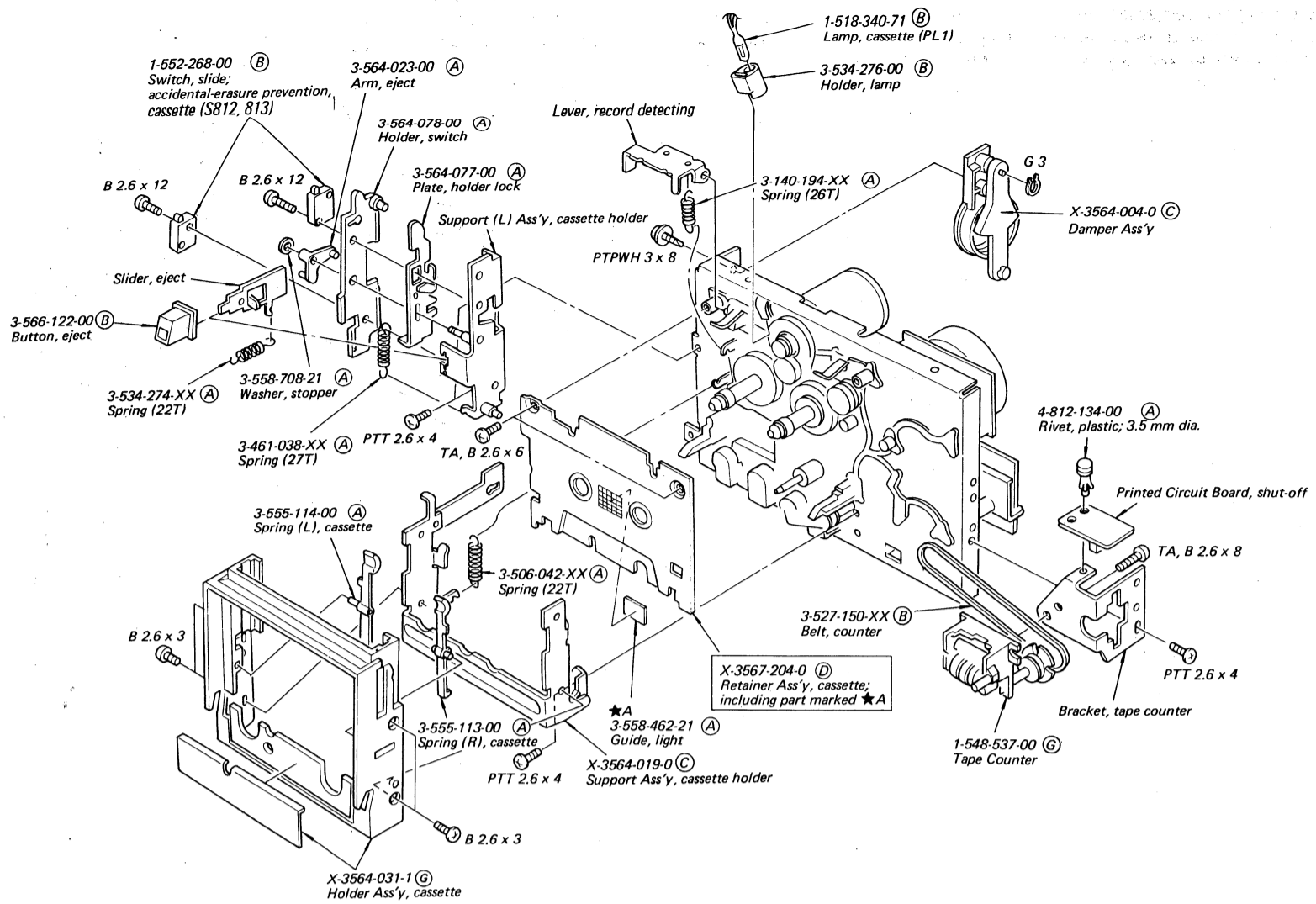

Note:

- Items with no part number and/or no description are not stocked because they are seldom required for routine service.
- All screws are Phillips (cross recess) type unless otherwise noted.
- (-) = slotted head

- (□□T) shows the number of coils in spring.
- Circled letters (A) to (Z) are applicable to European models only.

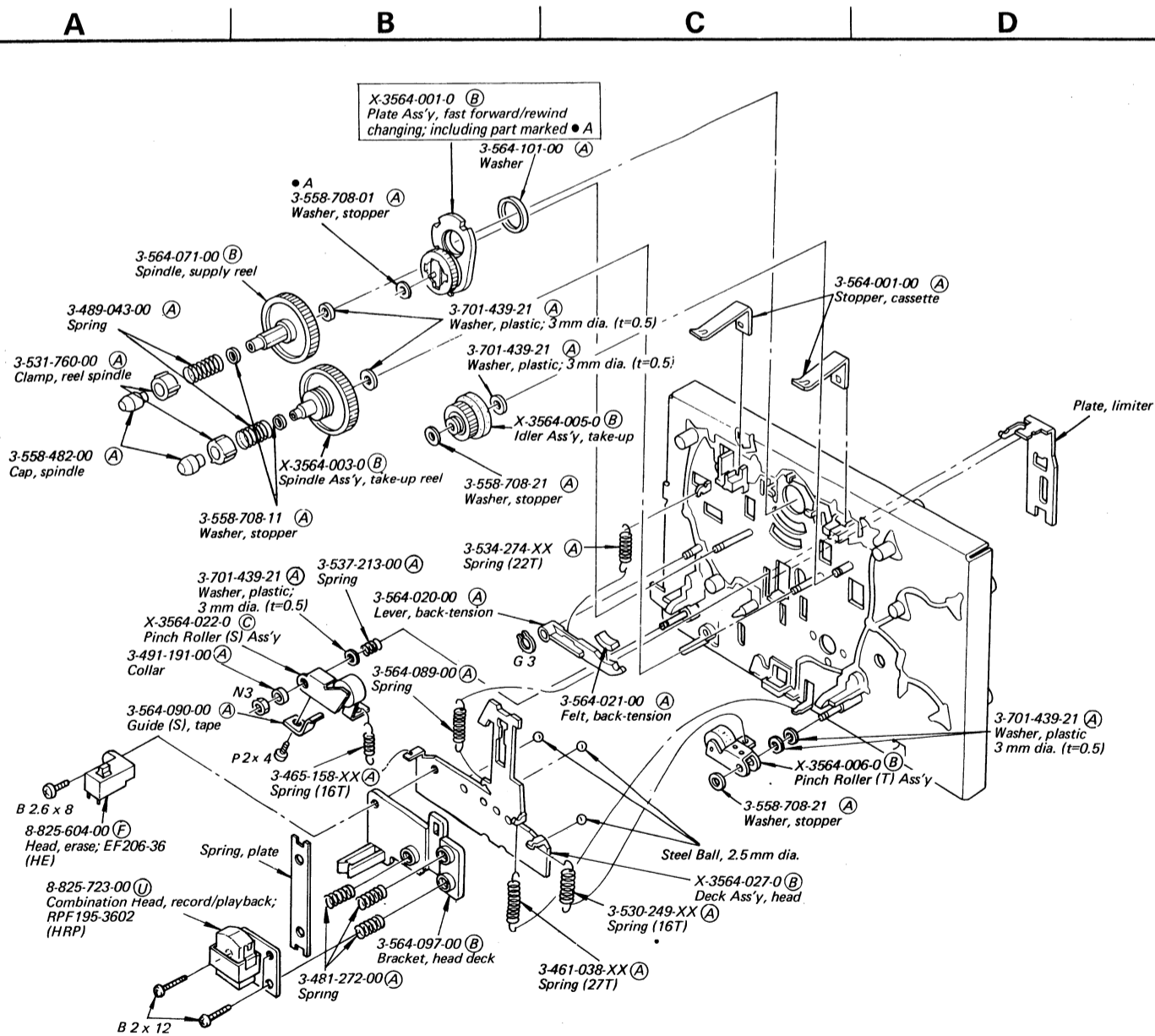

- Note:**
- Items with no part number and/or no description are not stocked because they are seldom required for routine service.
 - All screws are Phillips (cross recess) type unless otherwise noted.
 - (-) = slotted head

- (□□T) shows the number of coils in spring.
- Circled letters (A) to (Z) are applicable to European models only.

A B C D E

1
2
3

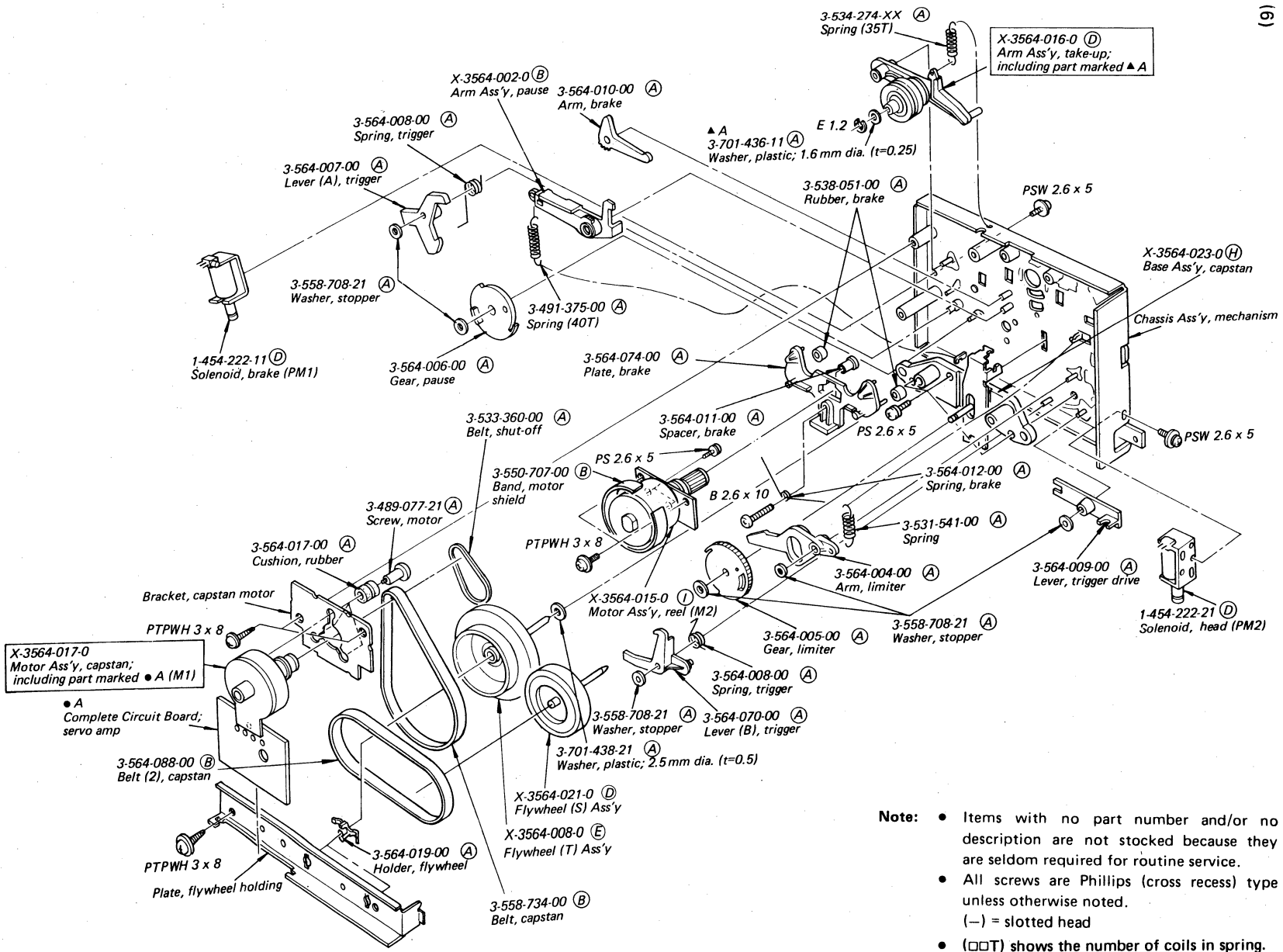

Note:

- Items with no part number and/or no description are not stocked because they are seldom required for routine service.
- All screws are Phillips (cross recess) type unless otherwise noted.
(-) = slotted head
- (□□T) shows the number of coils in spring.
- Circled letters (A to Z) are applicable to European models only.

TC-K75

**SECTION 6
ELECTRICAL PARTS LIST**

• Circled letters (A to Z) are applicable to European models only.

<u>Ref. No.</u>	<u>Part No.</u>	<u>Description</u>
Semiconductors		
Transistors		
Q101, 201	8-729-113-82	(K) 2SA1138
Q102, 202	8-729-167-62	(B) 2SC2676
⇒ Q103, 203	8-729-387-28	(B) 2SA872-E
Q104, 204	8-729-663-47	(C) 2SC1364
Q105, 205	8-729-100-13	(B) 2SC2001
Q106-108 Q206-208	8-729-663-47	(C) 2SC1364
⇒ Q109, 209		
Q110, 210	8-729-100-13	(B) 2SC2001
Q111, 211	8-729-663-47	(C) 2SC1364
Q301, 302 Q401, 402	8-729-334-58	(B) 2SC1345
Q501		
Q502	8-729-141-43	(B) 2SD414
⇒ Q503, 504	8-729-665-47	(B) 2SC1362
Q505	8-729-203-04	(B) 2SK30A
⇒ Q506, 507	8-729-612-77	(B) 2SA1027R
Q508	8-729-154-83	(B) 2SB548
⇒ Q509	8-760-413-10	(B) 2SC1475
Q510	8-729-663-47	(B) 2SC1364
⇒ Q511	8-729-612-77	(B) 2SA1027R
Q512-515	8-729-663-47	(B) 2SC1364
⇒ Q516	8-729-612-77	(B) 2SA1027R
Q518	8-729-663-47	(B) 2SC1364
Q601	8-729-101-31	(B) N13T1
Q602	8-729-663-47	(B) 2SC1364
Q603-606	8-729-195-23	(B) 2SA952
Q801	8-729-180-93	(B) 2SD809
⇒ Q802	8-729-612-77	(B) 2SA1027R
Q803	8-729-154-83	(B) 2SB548
⇒ Q804	8-729-663-47	(C) 2SC1364
Q805	8-729-154-83	(B) 2SB548
⇒ Q806	8-729-663-47	(C) 2SC1364
Q807	8-729-141-43	(B) 2SD414
⇒ Q808	8-729-612-77	(B) 2SA1027R
⇒ Q809	8-729-663-47	(C) 2SC1364
⇒ Q810	8-729-468-43	(C) 2SA684
Q811, 812	8-760-413-10	(B) 2SC1475

• ⇒ : Due to standardization, interchangeable replacements may be substituted for parts specified in the diagrams.

Note: The components identified by shading and mark  are critical for safety. Replace only with part number specified.

<u>Ref. No.</u>	<u>Part No.</u>	<u>Description</u>
⇒ Q817-819	8-729-663-47	(C) 2SC1364
Q820	8-729-101-03	(B) PH103
⇒ Q821	8-729-663-47	(C) 2SC1364
Q822	8-729-154-83	(B) 2SB548
⇒ Q823	8-729-663-47	2SC1364
⇒ 1001, 1002		
⇒ Q1003	8-760-335-10	(B) 2SC1474
⇒ Q1004	8-729-468-43	(C) 2SA684
⇒ Q1005	8-760-335-10	(C) 2SC1474
⇒ Q1006	8-729-468-43	(C) 2SA684
ICs		
IC101, 201	8-759-101-74	(F) CX174
IC102, 202	8-759-145-57	(D) μPC4557C
IC103, 203	8-759-145-58	(D) μPC4558C
IC104, 204	8-759-101-74	(F) CX174
IC501	8-759-145-57	(D) μPC4557C
IC601	8-759-993-50	MSL9350
IC801	8-759-147-42	(L) μPD547C-042
IC802, 803	8-759-904-69	(C) MSM4069
IC805	8-759-133-90	(F) μPC339C
IC806	8-759-145-58	(D) μPC4558C
IC1001	8-750-690-00	(D) CX069
⇒ IC1002	8-759-145-58	(D) μPC4558C
Diodes		
D101-106 D201-206	8-719-815-55	(B) 1S1555
⇒ D501, 502		
D503-510 D512-514	8-719-815-55	(B) 1S1555
D601		
D801-809	8-719-200-02	(B) 10E2
D810, 811	8-719-910-15	(B) HZ11B2L
D812, 813	8-719-815-55	(B) 1S1555
D814	8-719-200-02	(B) 10E2
D815	8-719-815-55	(B) 1S1555
⇒ D816	8-719-910-23	(B) HZ12A3L
D817	8-719-815-55	(B) 1S1555
⇒ D818	8-719-910-23	(B) HZ12A3L
⇒ D819	8-719-910-25	(B) HZ12B2L

Note: Les composants identifiés par un tramé et une marque  sont critiques pour la sécurité. Ne les remplacer que par une pièce portant le numéro spécifié.

• Circled letters (A to Z) are applicable to European models only.

• Circled letters (A to Z) are applicable to European models only.

Ref. No.	Part No.	Description
D821	8-719-200-02	(B) 10E2
D828-833	8-719-815-55	(B) 1S1555
D824		SEL1331G
D825	8-719-311-12	(B) SEL1112R
D826		SEL1741Y
D827	8-719-101-11	(B) SR110
⇒D1001	8-719-910-65	(B) HZ6B2L

COILS

L101, 201	1-407-240-00	(B) Inductor, variable
L102, 202	1-408-259-00	(B) 15 mH, microinductor

L301, 401	1-408-253-00	(B) 4.7 mH, microinductor
L302, 402	1-408-251-00	(B) 3.3 mH, microinductor
L303, 403	1-408-249-00	(B) 2.2 mH, microinductor
L304, 404	1-408-251-00	(B) 3.3 mH, microinductor

TRANSFORMERS

T301	1-433-213-00	(C) Osc
T901	(A) 1-446-351-00	(M) Power (AEP, UK model)
	(A) 1-446-350-00	Power (US, Canadian model)
	(A) 1-446-518-00	Power (E model)

CAPACITORS

All capacitors are in μF and ceramic unless otherwise noted. 50WV or less are not indicated except for electrolytics and tantalum. p: μF , elect: electrolytic

C102, 202	1-161-315-00	(A) 220p
C103, 203	1-161-313-00	(A) 150p
C104, 204	1-161-271-00	(A) 100p
C105, 205	1-121-419-00	(B) 220 6.3V elect
C106, 206	1-130-305-00	(B) 0.022 100V polyethylene
C107, 207	1-121-420-00	(A) 220 10V elect
C108, 208	1-121-414-00	(A) 100 10V elect
C109, 209	1-121-392-00	(A) 3.3 25V elect
C110, 210	1-130-307-00	(B) 0.027 100V polyethylene
C111, 211	1-161-323-00	(A) 0.001
C112, 212	1-161-271-00	(A) 100p
C113, 213	1-161-041-00	(A) 0.0015
C114, 214	1-121-409-00	(A) 47 16V elect
C115, 215	1-123-286-00	(B) 0.33 50V elect
C116, 216	1-108-603-00	(B) 0.1 mylar

Ref. No.	Part No.	Description
C117, 217	1-108-579-00	(A) 0.01 mylar
C118, 218	1-108-593-00	(A) 0.039 mylar
C119, 219	1-121-651-00	(A) 10 16V elect
C120, 220	1-121-409-00	(A) 47 16V elect
C121, 221	1-130-341-00	(B) 0.056 100V polyethylene
C122, 222	1-130-340-00	(B) 0.018 100V polyethylene
C123, 223	1-130-339-00	(B) 0.0056 100V polyethylene
C124, 224	1-123-232-00	(B) 4.7 50V elect (nonpolarized)
C125, 225	1-121-726-00	(A) 0.47 50V elect
C126, 226	1-123-228-00	(B) 1 50V elect (nonpolarized)
C127, 227	1-108-362-00	(B) 0.082 mylar
C128, 228	1-121-414-00	(A) 100 10V elect
C129, 229	1-121-651-00	(A) 10 16V elect
C130, 230		(A) 10 16V elect
C131, 231	1-121-414-00	(A) 100 10V elect
C132, 232	1-131-462-00	(B) 0.47 50V tantalum
C133, 233	1-161-375-00	(A) 0.0022
C134, 234	1-121-409-00	(A) 47 16V elect
C135, 235	1-123-286-00	(B) 0.33 50V elect
C136, 236	1-108-603-00	(B) 0.1 mylar
C137, 237	1-108-579-00	(A) 0.01 mylar
C138, 238	1-108-593-00	(A) 0.039 mylar
C139, 239	1-121-651-00	(A) 10 16V elect
C140, 240	1-121-409-00	(A) 47 16V elect
C141, 241	1-130-341-00	(B) 0.056 100V polyethylene
C142, 242	1-130-340-00	(B) 0.018 100V polyethylene
C143, 243	1-130-339-00	(B) 0.0056 100V polyethylene
C144, 244	1-123-232-00	(B) 4.7 50V elect (nonpolarized)
C145, 245	1-121-651-00	(A) 10 16V elect
C146, 246	1-161-271-00	(A) 100p
C147, 247	1-121-392-00	(A) 3.3 25V elect
C148, 248	1-108-593-00	(A) 0.039 mylar
C149, 249	1-121-414-00	(A) 100 10V elect
C150, 250	1-123-234-00	(B) 10 50V elect (nonpolarized)
C151, 251	1-161-041-00	(A) 0.0015
C152, 252	1-107-172-00	(B) 130p 500V mica

Ref. No.	Part No.	Description
C153, 253	1-107-036-00	(A) 68p 500V mica
C154, 254	1-141-225-00	(C) Trimmer
C155, 255	1-161-272-00	(A) 120p
C156, 256	1-123-232-00	(B) 4.7 50V elect (nonpolarized)
C157, 257	1-107-159-00	(B) 33p 500V mica
C301, 401	1-121-414-00	(A) 100 10V elect
C302, 402		(A) 100 10V elect
C303, 403	1-121-651-00	(A) 10 16V elect
C304, 404	1-161-323-00	(A) 0.001
C305, 405	1-123-230-00	(B) 2.2 50V elect
C306, 406	1-121-912-00	(A) 1 50V elect
C307, 407	1-121-651-00	(A) 10 16V elect
C308, 408	1-121-414-00	(A) 100 10V elect
C309, 409	1-108-589-00	(A) 0.027 mylar
C310, 410	1-108-588-00	(B) 0.024 mylar
C311, 411	1-108-593-00	(A) 0.039 mylar
C312, 412	1-108-589-00	(B) 0.027 mylar
C313, 413	1-108-587-00	(B) 0.022 mylar
C314, 414		(B) 0.022 mylar
C315, 415	1-108-585-00	(B) 0.018 mylar
C501	1-121-733-00	(B) 470 25V elect
C502	1-121-414-00	(A) 100 10V elect
C503	1-121-426-00	(B) 470 16V elect
C504	1-121-416-00	(B) 100 25V elect
C505	1-121-414-00	(A) 100 10V elect
C506	1-121-426-00	(B) 470 16V elect
C507	1-130-338-00	0.01 630V polyethylene
C508	1-129-701-00	(A) 0.01 100V polyethylene
C509	1-130-189-00	(B) 0.018 100V polyethylene
C510	1-131-218-00	(A) 3.3 35V tantalum
C511	1-121-726-00	(A) 0.47 50V elect
C512, 513	1-121-414-00	(A) 100 10V elect
C514	1-121-391-00	(A) 1 50V elect
C515	1-161-271-00	(A) 100p
C516, 517	1-108-561-00	(B) 0.0018 mylar
C519, 520	1-108-587-00	(B) 0.022 mylar
C521	1-121-479-00	(A) 22 16V elect
C522	1-161-315-00	(A) 220p
C523	1-108-569-00	(B) 0.0039 mylar
C524	1-121-391-00	(A) 1 50V elect

Ref. No.	Part No.	Description
C525	1-108-593-00	(A) 0.039 mylar
C526, 527	1-121-479-00	(A) 22 16V elect
C528	1-121-402-00	(B) 33 10V elect
C529	1-121-450-00	(A) 2.2 50V elect
C601	1-121-651-00	(A) 10 16V elect
C602	1-123-354-00	(B) 3.3 50V elect
C603	1-108-251-00	(B) 0.1 mylar
C604	1-123-306-00	(B) 47 10V elect
C801, 802	(A) 1-123-337-00	(B) 1000 25V elect
C803, 804	(A) 1-123-324-00	(B) 1000 16V elect
C805	1-123-319-00	(B) 47 16V elect
C806	1-123-307-00	(A) 100 10V elect
C807	1-123-329-00	(B) 10 25V elect
C808	1-123-316-00	(B) 10 16V elect
C809	1-123-320-00	(B) 100 16V elect
C810	1-123-328-00	(B) 4.7 25V elect
C819	1-123-316-00	(B) 10 16V elect
C820	1-123-352-00	(B) 1 50V elect
C821	1-108-244-00	(A) 0.033 mylar
C822, 823	1-123-351-00	(B) 0.47 50V elect
C824	1-123-328-00	(B) 4.7 25V elect
C825, 826	1-123-351-00	(B) 0.47 50V elect
C827	1-123-352-00	(B) 1 50V elect
C828, 829	1-161-263-00	(A) 22p
C830, 831	1-161-051-00	(A) 0.01
C832	1-123-319-00	(B) 47 16V elect
C833, 834	1-161-051-00	(A) 0.01
C835	1-123-310-00	(B) 470 10V elect
C836	1-123-353-00	(B) 2.2 50V elect
C837	1-123-352-00	(B) 1 50V elect
C839	1-108-579-00	(B) 0.01 mylar
C901, 902	(A) 1-130-267-00	(C) 0.022 250V film (dual type) (AEP, UK model)
C1001, 1002	1-123-306-00	(B) 47 10V elect
C1003	1-123-316-00	(B) 10 16V elect
C1004	1-123-354-00	(B) 3.3 50V elect
C1005	1-130-134-00	(B) 0.082 100V polyethylene
C1006-1008	1-161-379-00	(A) 0.01
C1009	1-108-583-00	(A) 0.015 mylar

• ⇒ : Due to standardization, interchangeable replacements may be substituted for parts specified in the diagrams.

Note: The components identified by shading and mark **A** are critical for safety. Replace only with part number specified.

Note: Les composants identifiés par un trame et une marque **A** sont critiques pour la sécurité. Ne les remplacer que par une pièce portant le numéro spécifié.

Note: The components identified by shading and mark **A** are critical for safety. Replace only with part number specified.

Note: Les composants identifiés par un trame et une marque **A** sont critiques pour la sécurité. Ne les remplacer que par une pièce portant le numéro spécifié.

• Circled letters (A to Z) are applicable to European models only.

Ref. No.	Part No.	Description
RESISTORS		
All resistors are in ohms. Common 1/4W carbon resistors are omitted. Refer to the list on page 47 for their part numbers. kΩ: 1000 Ω, MΩ: 1000 kΩ		
R101, 201	1-244-933-00	(A) 330k 1/2W carbon
R102, 202	1-244-849-00	(A) 100 1/2W carbon
R104, 204	1-244-890-00	(A) 5.1k 1/2W carbon
R134, 234	1-244-881-00	(A) 2.2k 1/2W carbon
R144, 244	1-244-849-00	(A) 100 1/2W carbon
R149, 249	1-244-847-00	(A) 82 1/2W carbon
R161, 261 162, 262	1-244-881-00	(A) 2.2k 1/2W carbon
R164, 264	1-244-913-00	(A) 47k 1/2W carbon
R502	1-244-865-00	(A) 470 1/2W carbon
R503	1-244-871-00	(A) 820 1/2W carbon
R505	1-244-865-00	(A) 470 1/2W carbon
R506	1-244-871-00	(A) 820 1/2W carbon
R532, 533	1-244-849-00	(A) 100 1/2W carbon
R802	1-212-867-00	(A) 27 1/4W fusible
R805	1-211-638-00	(A) 1k 1/2W carbon (nonflammable)
R806	1-212-841-00	(B) 2.2 1/4W fusible
R814, 820	1-212-857-00	(A) 10 1/4W fusible
R922	1-246-433-00	(A) 22 1/4W carbon
R1001	1-214-777-00	(A) 100k 1/4W metal oxide (1%)

Note: The components identified by shading and mark  are critical for safety. Replace only with part number specified.

Ref. No.	Part No.	Description
RV101, 201	1-224-645-XX	(B) 10k-B, adjustable; playback level
RV102, 202	1-226-235-00	(A) 5k-B, adjustable; REC level CAL
RV103, 203	1-226-140-00	(D) 20k/20k-B, variable; HEADPHONES/LINE OUT
RV104, 204	1-226-235-00	(A) 5k-B, adjustable; level meter
RV105, 205	1-226-560-00	(C) 5k-B, variable; REC LEVEL CAL
RV106, 206	1-224-646-XX	(B) 22k-B, adjustable; record level
RV301, 401	1-226-132-00	(E) 20k/20k-A, variable; REC LEVEL
RV501	1-226-560-00	(C) 5k-B, variable; BIAS CAL
RV502, 503	1-226-232-00	(B) 500-B, adjustable
RV1001	1-226-433-00	(B) 50k-B, adjustable; tape speed

SWITCHES

S101	1-552-907-00	(D) Slide, MONITOR
S102	1-552-964-00	(D) Rotary, CALIBRATION
S103	1-552-879-00	(C) Pushbutton, INPUT SELECT
S104	1-552-880-00	(C) Slide, DOLBY NR
S105	1-552-878-00	(D) Slide, EQ
S106	1-552-877-00	(C) Slide, BIAS
S107	1-552-876-00	(D) Pushbutton PEAK HOLD RESET
S801	1-552-747-00	(A) Rotary, POWER (US, Canadian model)
	1-552-906-00	(E) Rotary, POWER (AEP, UK, E model)
S802-808	1-552-919-00	(K) Block, function included in tape counter
S809		
S810, 811	1-552-520-00	(C) Slide, MEMORY, timer
S812, 813	1-552-268-00	(B) Slide, accidental-erasure prevention, cassette

JACKS

CNJ101,102 CNJ201,202	1-507-531-00	(C) LINE IN, LINE OUT (fixed)
CNJ103,203	1-507-526-21	(B) LINE OUT (variable)
CNJ301	1-507-553-00	(C) HEADPHONES
CNJ302	1-507-525-00	(D) MIC

Note: Les composants identifiés par un trame et une marque  sont critiques pour la sécurité. Ne les remplacer que par une pièce portant le numéro spécifié.

Ref. No.	Part No.	Description
----------	----------	-------------

MISCELLANEOUS

CP901	1-231-326-11	(A) Encapsulated Component (US model)
	1-231-341-00	(D) Encapsulated Component (Canadian, E model)
CNJ901	1-561-293-00	(D) Socket, 4-p; REMOTE
CNJ902	1-526-528-00	(A) Socket, AC OUTLET (US, Canadian model)
HE	8-825-604-00	(F) Head, erase; EF206-36
HRP	8-825-723-00	(U) Combination Head, record/playback; RPF195-3602
LPF101,201	1-231-388-00	(D) Filter, low-pass
PL1, 2	1-518-340-71	(B) Lamp, cassette, meter
PL501,502	1-518-386-00	(B) Lamp
PM1	1-454-222-11	(D) Solenoid, brake
PM2	1-454-222-21	(D) Solenoid, head
M1	X-3564-017-0	(K) Motor Ass'y, capstan
M2	X-3564-015-0	(I) Motor Ass'y, reel
	1-526-576-23	(A) Voltage Selector (E model)
	1-534-777-00	(D) Cord, power (UK model)
	1-534-817-XX	(D) Cord, power (AEP, E model)
	1-534-986-XX	(A) Cord, power (US, Canadian model)
	1-551-473-31	(A) Cord, power; parallel-blade plug (E model)

Note: The components identified by shading and mark  are critical for safety. Replace only with part number specified.

• Circled letters (A to Z) are applicable to European models only.

ACCESSORIES AND PACKING MATERIALS

Part No.	Description
X-3701-105-0	(A) Tip Ass'y, head cleaning
1-551-734-11	(D) Cord, connection; RK-74A
3-561-142-00	Cushion, upper-front (Canadian model)
3-561-143-00	Cushion, upper-rear (Canadian model)
3-561-144-00	Cushion, bottom-right (Canadian model)
3-561-145-00	Cushion, bottom-left (Canadian model)
3-566-148-00	(B) Cushion, upper-front (AEP, UK, US, E model)
3-566-149-00	(B) Cushion, upper-rear (AEP, UK, US, E model)
3-556-150-00	(B) Cushion, bottom-right (AEP, UK, US, E model)
3-566-151-00	(B) Cushion, bottom-left (AEP, UK, US, E model)
3-567-247-00	(E) Carton, for set (AEP, UK, US, E model)
3-567-248-00	Carton, for set (Canadian model)
3-567-250-00	Carton, for remote control RM-50 (E model)
3-701-630-00	(A) Bag, plastic
3-701-684-11	Card, voltage indication (E model)
3-770-829-11	(E) Manual, instruction (AEP, UK, E model)
3-770-829-21	Manual, instruction (US model)
3-770-829-21 3-794-537-31	Manual, instruction (Canadian model)
3-793-481-12	(A) Leaflet
3-793-828-11	(A) Caution Card, cassette
3-794-559-51	Manual, instruction; remote control (E model)

Note: Les composants identifiés par un trame et une marque  sont critiques pour la sécurité. Ne les remplacer que par une pièce portant le numéro spécifié.

1/4 WATT CARBON RESISTORS [Ⓐ]

Note: Circled letter [Ⓐ] is applicable to European models only.

Ω	Part No.	Ω	Part No.	Ω	Part No.	Ω	Part No.	Ω	Part No.	Ω	Part No.	Ω	Part No.
1.0	1-246-401-00	10	1-246-425-00	100	1-246-449-00	1.0k	1-246-473-00	10k	1-246-497-00	100k	1-246-521-00	1.0M	1-246-545-00
1.1	1-246-402-00	11	1-246-426-00	110	1-246-450-00	1.1k	1-246-474-00	11k	1-246-498-00	110k	1-246-522-00	1.1M	1-210-814-00
1.2	1-246-403-00	12	1-246-427-00	120	1-246-451-00	1.2k	1-246-475-00	12k	1-246-499-00	120k	1-246-523-00	1.2M	1-210-815-00
1.3	1-246-404-00	13	1-246-428-00	130	1-246-452-00	1.3k	1-246-576-00	13k	1-246-500-00	130k	1-246-524-00	1.3M	1-210-816-00
1.5	1-246-405-00	15	1-246-429-00	150	1-246-453-00	1.5k	1-246-577-00	15k	1-246-501-00	150k	1-246-525-00	1.5M	1-210-817-00
1.6	1-246-406-00	16	1-246-430-00	160	1-246-454-00	1.6k	1-246-578-00	16k	1-246-502-00	160k	1-246-526-00	1.6M	1-210-818-00
1.8	1-246-407-00	18	1-246-431-00	180	1-246-455-00	1.8k	1-246-579-00	18k	1-246-503-00	180k	1-246-527-00	1.8M	1-210-819-00
2.0	1-246-408-00	20	1-246-432-00	200	1-246-456-00	2.0k	1-246-580-00	20k	1-246-504-00	200k	1-246-528-00	2.0M	1-210-820-00
2.2	1-246-409-00	22	1-246-433-00	220	1-246-457-00	2.2k	1-246-581-00	22k	1-246-505-00	220k	1-246-529-00	2.2M	1-210-821-00
2.4	1-246-410-00	24	1-246-434-00	240	1-246-458-00	2.4k	1-246-582-00	24k	1-246-506-00	240k	1-246-530-00	2.4M	1-244-754-00
2.7	1-246-411-00	27	1-246-435-00	270	1-246-459-00	2.7k	1-246-583-00	27k	1-246-507-00	270k	1-246-531-00	2.7M	1-244-755-00
3.0	1-246-412-00	30	1-246-436-00	300	1-246-460-00	3.0k	1-246-584-00	30k	1-246-508-00	300k	1-246-532-00	3.0M	1-244-756-00
3.3	1-246-413-00	33	1-246-437-00	330	1-246-461-00	3.3k	1-246-585-00	33k	1-246-509-00	330k	1-246-533-00	3.3M	1-244-757-00
3.6	1-246-414-00	36	1-246-438-00	360	1-246-462-00	3.6k	1-246-586-00	36k	1-246-510-00	360k	1-246-534-00	3.6M	1-244-758-00
3.9	1-246-415-00	39	1-246-439-00	390	1-246-463-00	3.9k	1-246-587-00	39k	1-246-511-00	390k	1-246-535-00	3.9M	1-244-759-00
4.3	1-246-416-00	43	1-246-440-00	430	1-246-464-00	4.3k	1-246-488-00	43k	1-246-512-00	430k	1-246-536-00	4.3M	1-244-760-00
4.7	1-246-417-00	47	1-246-441-00	470	1-246-465-00	4.7k	1-246-489-00	47k	1-246-513-00	470k	1-246-537-00	4.7M	1-244-761-00
5.1	1-246-418-00	51	1-246-442-00	510	1-246-466-00	5.1k	1-246-490-00	51k	1-246-514-00	510k	1-246-538-00	5.1M	1-244-762-00
5.6	1-246-419-00	56	1-246-443-00	560	1-246-467-00	5.6k	1-246-491-00	56k	1-246-515-00	560k	1-246-539-00		
6.2	1-246-420-00	62	1-246-444-00	620	1-246-468-00	6.2k	1-246-492-00	62k	1-246-516-00	620k	1-246-540-00		
6.8	1-246-421-00	68	1-246-445-00	680	1-246-469-00	6.8k	1-246-493-00	68k	1-246-517-00	680k	1-246-541-00		
7.5	1-246-422-00	75	1-246-446-00	750	1-246-470-00	7.5k	1-246-494-00	75k	1-246-518-00	750k	1-246-542-00		
8.2	1-246-423-00	82	1-246-447-00	820	1-246-471-00	8.2k	1-246-495-00	82k	1-246-519-00	820k	1-246-543-00		
9.1	1-246-424-00	91	1-246-448-00	910	1-246-472-00	9.1k	1-246-496-00	91k	1-246-520-00	910k	1-246-544-00		

Screw:

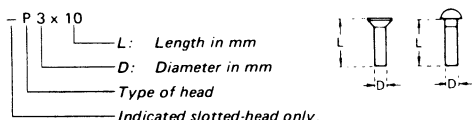

Unless otherwise indicated, it means cross-recessed head (Phillips type).

Nut, Washer, Retaining ring:

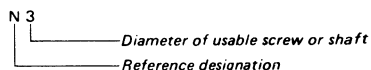

Reference Designation	Shape	Description	Remarks
SCREWS			
P		pan-head screw	binding-head (B) screw for replacement
PWH		pan-head screw with washer face	binding-head (B) screw and flat washer for replacement
PS PSP		pan-head screw with spring washer	binding-head (B) screw and spring washer for replacement
PSPW		pan-head screw with spring and flat washers	binding-head (B) screw and spring and flat washers for replacement
R		round-head screw	binding-head (B) screw for replacement
K		flat-countersunk-head screw	
RK		oval-countersunk-head screw	
B		binding-head screw	
T		truss-head screw	binding-head (B) screw for replacement
F		flat-fillister-head screw	
RF		fillister-head screw	
BV		braizer-head screw	

Reference Designation	Shape	Description	Remarks
SELF-TAPPING SCREWS			
TA		self-tapping screw	ex: TA, P 3 x 10
PTP		pan-head self-tapping screw	binding-head self-tapping (TA, B) screw for replacement
PTPWH		pan-head self-tapping screw with washer face	binding-head self-tapping (TA, B) screw and flat washer for replacement
PTTWH		pan-head thread-rolling screw with washer face	binding-head (B) screw and flat washer for replacement
SET SCREWS			
SC		set screw	
SC		hexagon-socket set screw	ex: SC 2.6 x 4, hexagon socket
NUT			
N		nut	
WASHERS			
W		flat washer	
SW		spring washer	
LW		internal-tooth lock washer	ex: LW3, internal
LW		external-tooth lock washer	ex: LW3, external
RETAINING RINGS			
E		retaining ring	
G		grip-type retaining ring	

RM-50

E Model

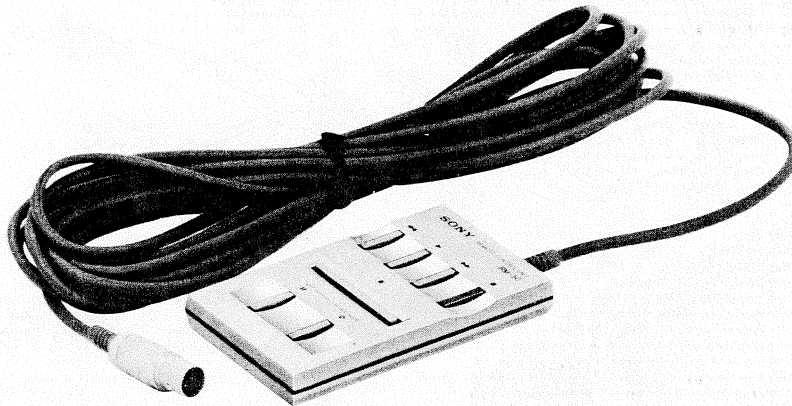

REMOTE CONTROL

1. MOUNTING DIAGRAM

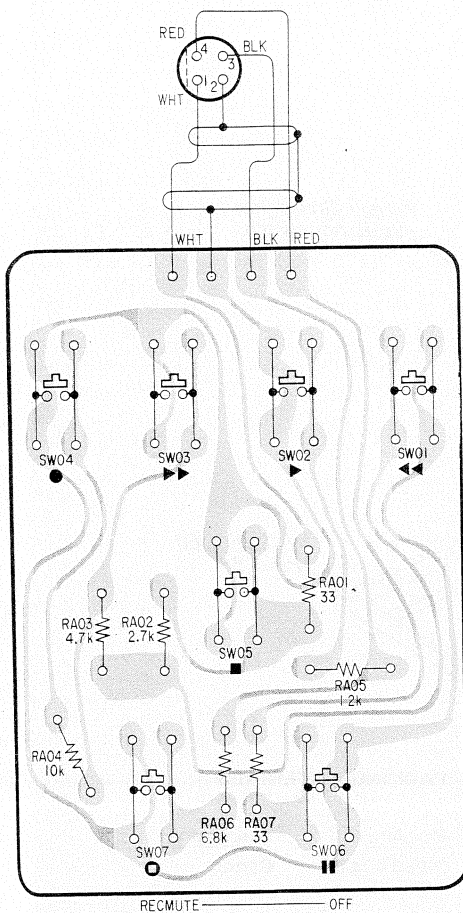

SPECIFICATIONS

- Dimensions:** Approx. 64(w) x 14(h) x 100(d) mm
2½(w) x 9/16 (h) x 3¹⁵/₁₆ (d) inches
- Weight:** Approx. 200g, 7 oz (including cord)
- Cord:** Approx. 5m, 16'8"

2. SCHEMATIC DIAGRAM

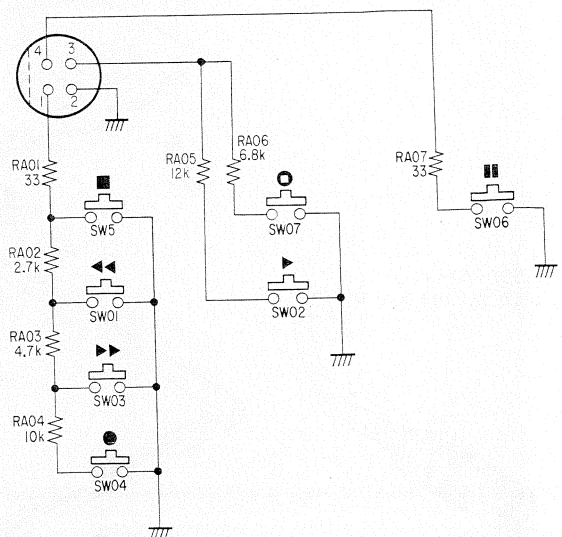

SONY[®]
SERVICE MANUAL

3. EXPLODED VIEWS

A

B

C

- Items with no part number and/or no description are not stocked because they are seldom required for routine service.
- All screws are Phillips (cross recess) type unless otherwise noted.
(-) = slotted head

1
2
3
4
5

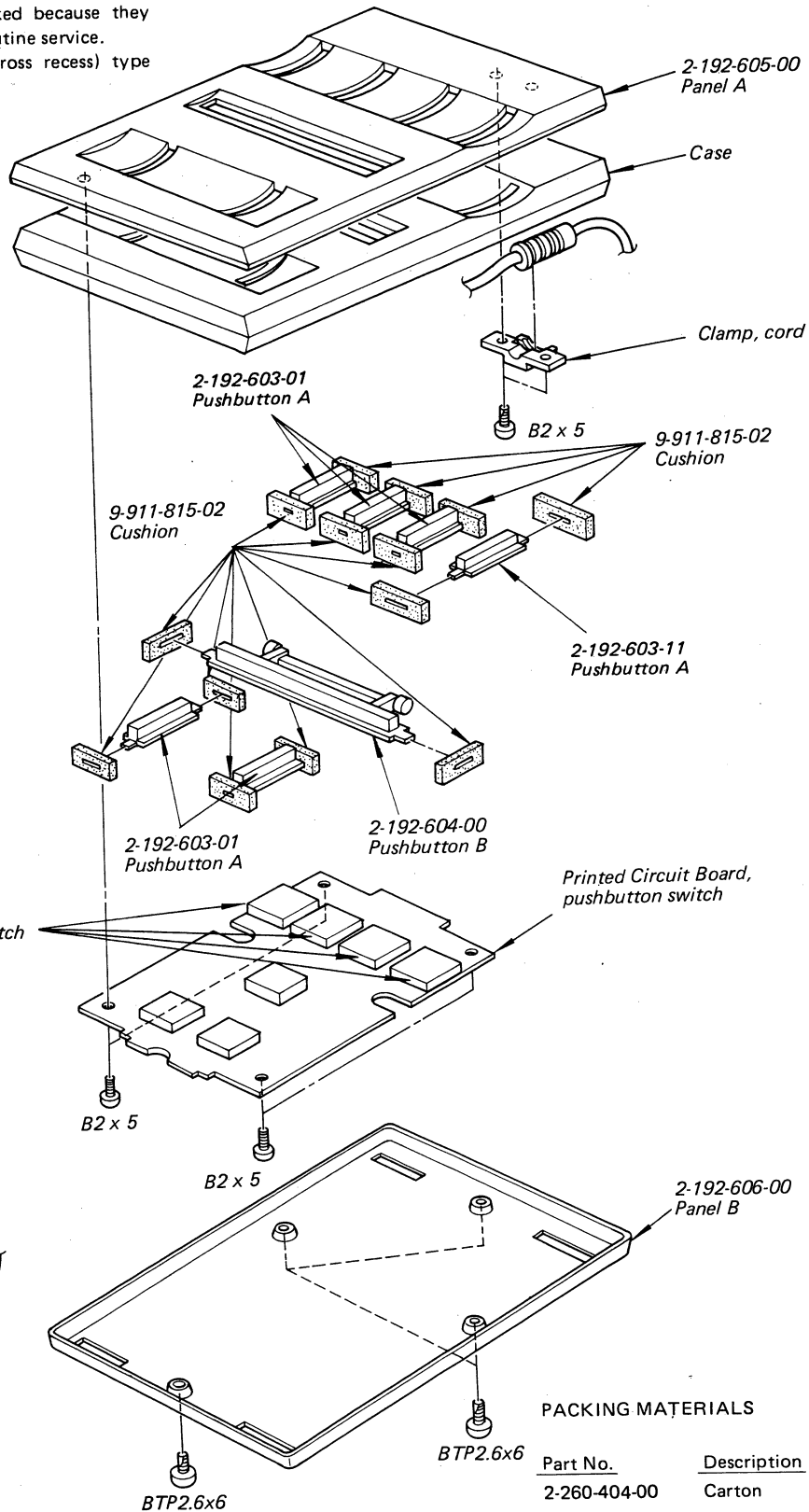

PACKING MATERIALS

Part No.	Description
2-260-404-00	Carton