

JVC

SERVICE MANUAL

DIGITAL SURROUND SYSTEM RECEIVER

RX-805VTN/RX-805VLTN

〒100 東京都千代田区日本橋本町4-9-14

株式会社ビクター

オーディオ部 **AV COMPU LINK**

COMPU LINK
Remote Control Component

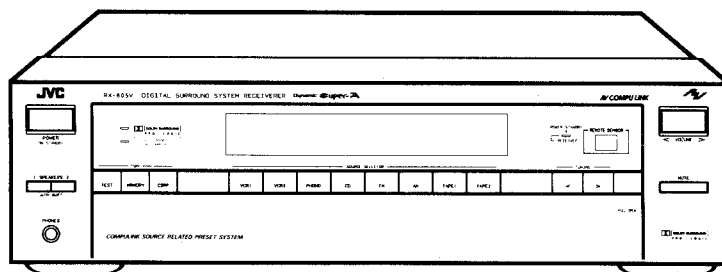
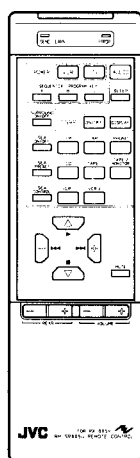

Contents

	Page		Page
Safety Precautions	1-2	FM/AM Tuner Alignment Procedures	1-47
Instruction Book	1-3	Power Amplifier Adjustment Procedures ...	1-48
Technical Explanation	1-34	Block Diagrams	1-50
Description of Major LSIs	1-35	Schematic Diagrams	Insertion
Internal Block Diagram of Other ICs	1-37	Printed Circuit Boards	Insertion
Internal Wiring of FL Display	1-44	Connection Diagram	Insertion
Disassembly Procedures	1-46	Parts List	Separate-volume Insertion

Safety Precautions

1. The design of this product contains special hardware and many circuits and components specially for safety purposes. For continued protection, no changes should be made to the original design unless authorized in writing by the manufacturer. Replacement parts must be identical to those used in the original circuits. Services should be performed by qualified personnel only.
2. Alterations of the design or circuitry of the product should not be made. Any design alterations of the product should not be made. Any design alterations or additions will void the manufacturer's warranty and will further relieve the manufacture of responsibility for personal injury or property damage resulting therefrom.
3. Many electrical and mechanical parts in the products have special safety-related characteristics. These characteristics are often not evident from visual inspection nor can the protection afforded by them necessarily be obtained by using replacement components rated for higher voltage, wattage, etc. Replacement parts which have these special safety characteristics are identified in the Parts List of Service Manual. Electrical components having such features are identified by shading on the schematics and by (Δ) on the Parts List in the Service Manual. The use of a substitute replacement which does not have the same safety characteristics as the recommended replacement parts shown in the Parts List of Service Manual may create shock, fire, or other hazards.
4. The leads in the products are routed and dressed with ties, clamps, tubings, barriers and the like to be separated from live parts, high temperature parts, moving parts and/or sharp edges for the prevention of electric shock and fire hazard. When service is required, the original lead routing and dress should be observed, and it should be confirmed that they have been returned to normal, after re-assembling.

5. Leakage current check (Electrical shock hazard testing)

After re-assembling the product, always perform an isolation check on the exposed metal parts of the product (antenna terminals, knobs, metal cabinet, screw heads, headphone jack, control shafts, etc.) to be sure the product is safe to operate without danger of electrical shock.

Do not use a line isolation transformer during this check.

- Plug the AC line cord directly into the AC outlet. Using a "Leakage Current Tester", measure the leakage current from each exposed metal parts of the cabinet, particularly any exposed metal part having a return path to the chassis, to a known good earth ground. Any leakage current must not exceed 0.5mA AC (r.m.s.).

● Alternate check method

Plug the AC line cord directly into the AC outlet. Use an AC voltmeter having, 1,000 ohms per volt or more sensitivity in the following manner. Connect a 1,500 Ω 10 W resistor paralleled by a 0.15 μ F AC-type capacitor between an exposed metal part and a known good earth ground.

Measure the AC voltage across the resistor with the AC voltmeter.

Move the resistor connection to each exposed metal part, particularly any exposed metal part having a return path to the chassis, and measure the AC voltage across the resistor.

Now, reverse the plug in the AC outlet and repeat each measurement. Any voltage measured must not exceed 0.75 V AC (r.m.s.).

This corresponds to 0.5 mA AC (r.m.s.).

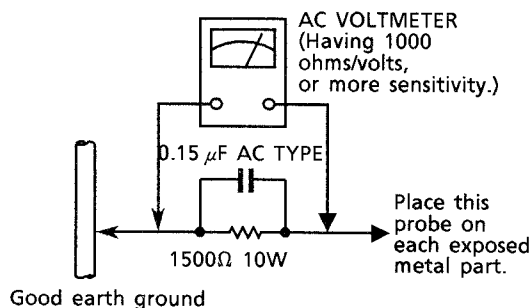

Warning

1. This equipment has been designed and manufactured to meet international safety standards.
2. It is the legal responsibility of the repairer to ensure that these safety standards are maintained.
3. Repairs must be made in accordance with the relevant safety standards.
4. It is essential that safety critical components are replaced by approved parts.
5. If mains voltage selector is provided, check setting for local voltage.

Rear Panel

- Switch the power off when connecting any cables.

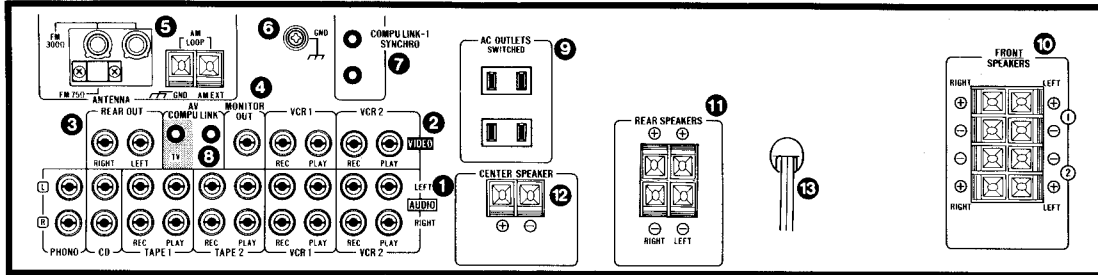

1 AUDIO terminals

(PHONO, CD, TAPE 1, TAPE 2, VCR 1, VCR 2)

— For audio signal connection

- Connect a turntable using a moving magnet (MM) type cartridge to the PHONO terminals.

2 VIDEO terminals

(VCR 1, VCR 2)

— For video signal connection

3 REAR OUT terminals

— To upgrade the rear speaker sound (to get more power), connect an amplifier to these terminals.

In this case, disconnect the rear speakers from the REAR SPEAKERS terminals, and connect them to the amplifier.

4 MONITOR OUT terminals

— Connect the VIDEO INPUT terminal of a TV.

5 ANTENNA terminals

6 GND (ground) terminal

7 COMPU LINK-1 SYNCHRO terminals

— Connect to units provided with COMPU LINK-1 SYNCHRO terminals for the COMPU LINK remote control function.

- Do not connect the remote cable to the JVC cassette deck connected to the terminals other than TAPE 1.

8 AV COMPU LINK terminals

— Connect to JVC video components provided with AV COMPU LINK terminals for the AV COMPU LINK function.

9 AC OUTLETS (SWITCHED)

10 FRONT SPEAKERS terminals

11 REAR SPEAKERS terminals

12 CENTER SPEAKER terminal

13 Power Cord

Notes:

- When connecting components, connect their left and right channels correctly. If channels are reversed, the stereo effect will be degraded.
- The AC OUTLETS do not supply power when the power switch is turned off.
- Do not connect equipment requiring more than the outlet's rated value.

Antennas

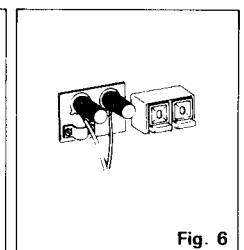
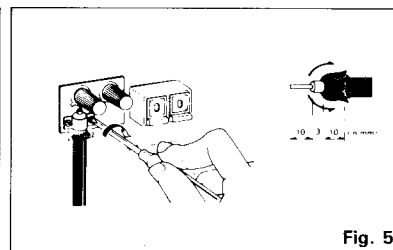
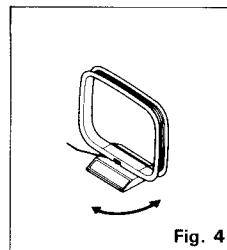
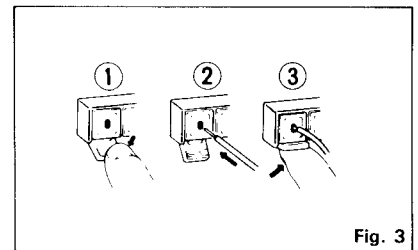
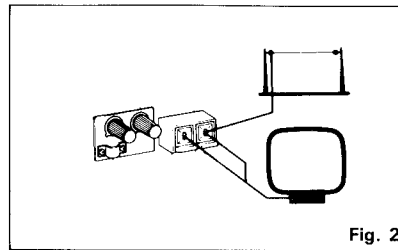
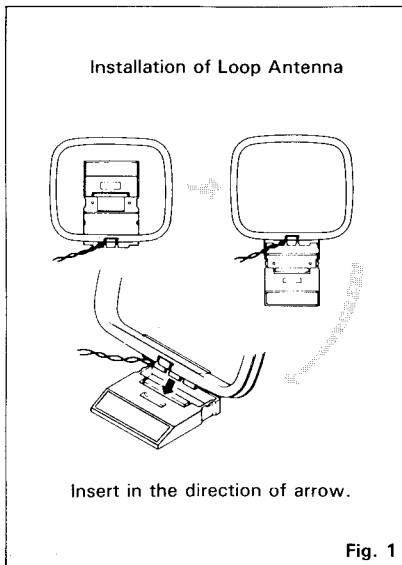

AM antennas

Figure 1: How to assemble the AM loop antenna

Figure 2: AM loop antenna

This antenna is for the reception of local AM broadcasts.

Figure 2: AM external antenna

If AM reception is unsatisfactory, connect an external AM antenna (single-wire antenna) to the AM EXT terminal.

Figure 3: Connection of AM antenna

- ① Open antenna terminals levers.
- ② Plug cords into the terminals.
- ③ Close the levers.

Figure 4: Noise and interference

Change the direction of the loop antenna, or re-install it in a better position if the reception is noisy.

Notes:

- If the provided loop antenna is not connected or an uninsulated antenna wire touches the rear panel, it will be impossible to receive AM broadcasts.
- When installing an external AM antenna, leave the AM loop antenna connected.

FM antennas

Figure 5: 75-ohm FM antenna with coaxial

Loosen the screws on the bracket and insert the cable through the ring from below. Connect the stripped core to the upper terminal then tighten the ring. The ring is the antenna ground.

Figure 6: FM Feeder antenna

Connect to the FM 300 Ω terminal. Make sure the feeder antenna wires do not touch any other terminals.

Antenna Connections

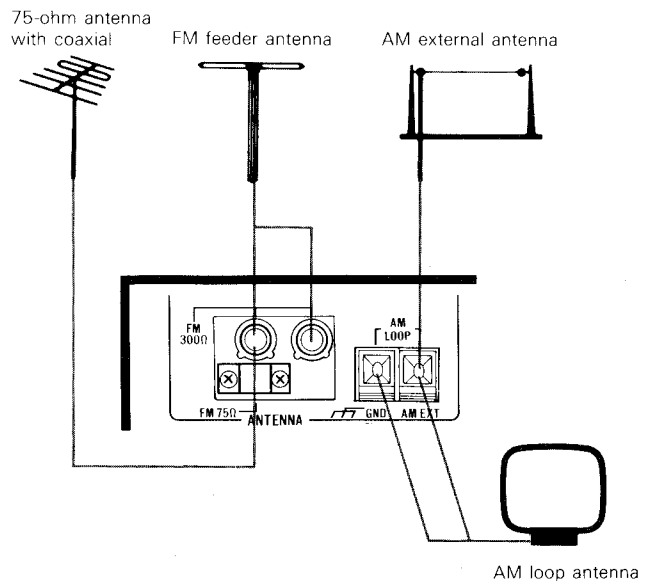

Audio Component Connections

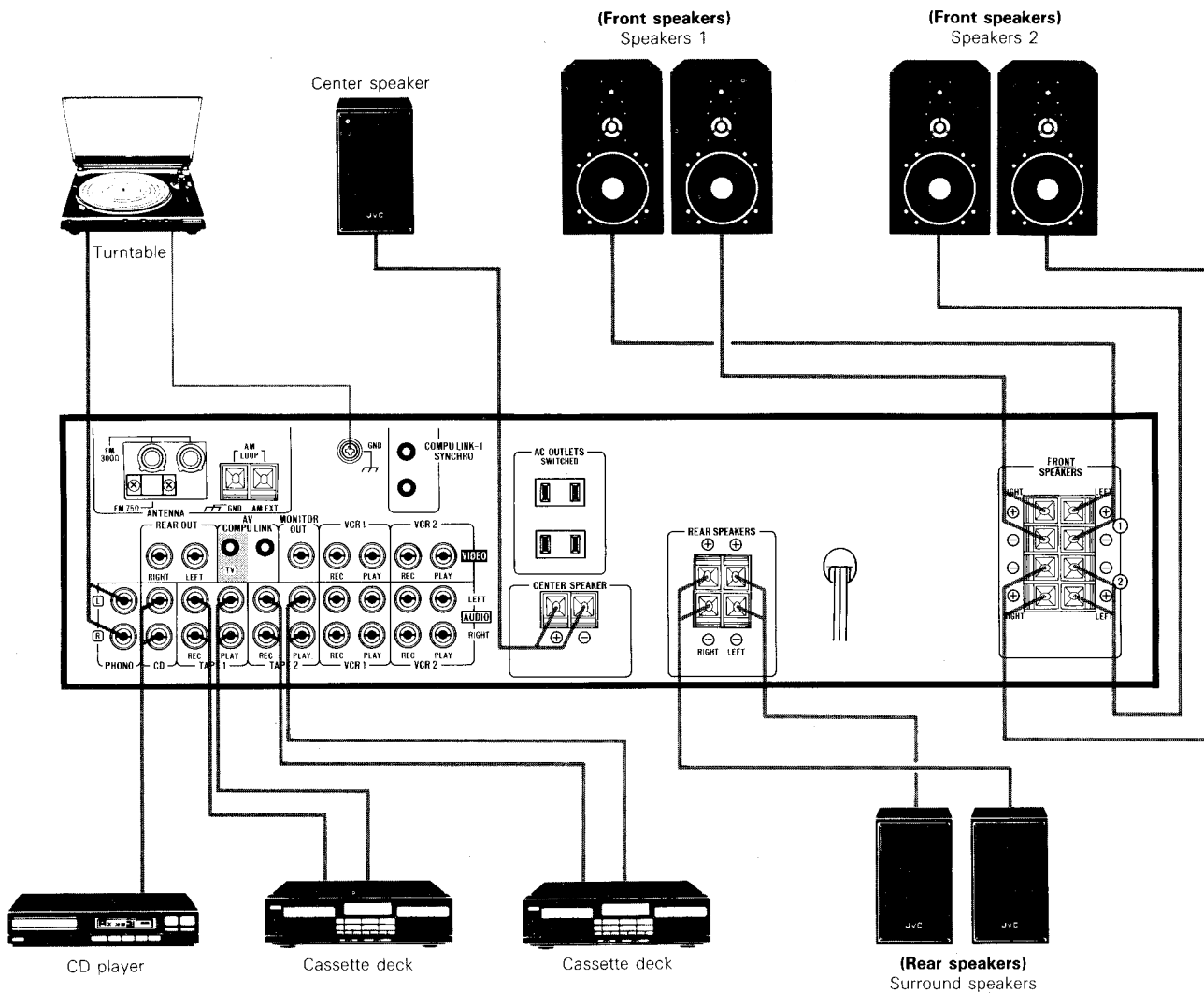

Speaker Terminals

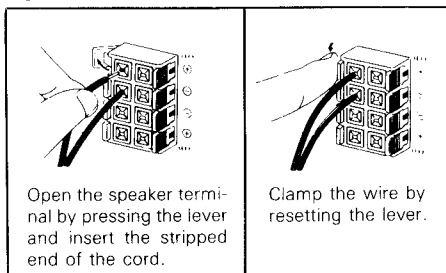

Notes:

- Connect speakers with the correct polarity: (+) to (+) and (-) to (-). Reversed polarity will degrade the stereo effect. Be careful to prevent adjacent speaker wires from touching each other.
- Use speakers with the correct impedance. The correct impedance is indicated on the rear panel of the receiver.

• Increasing the Rear speakers' power output

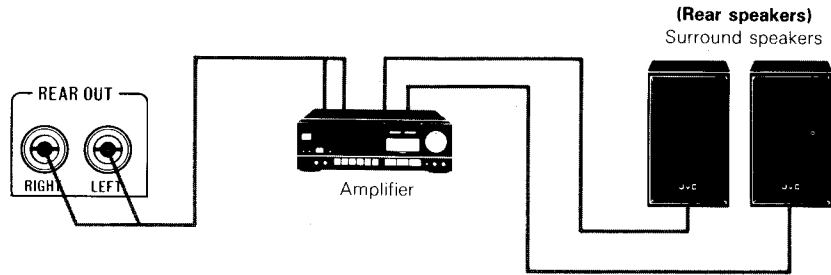

Video Component Connections

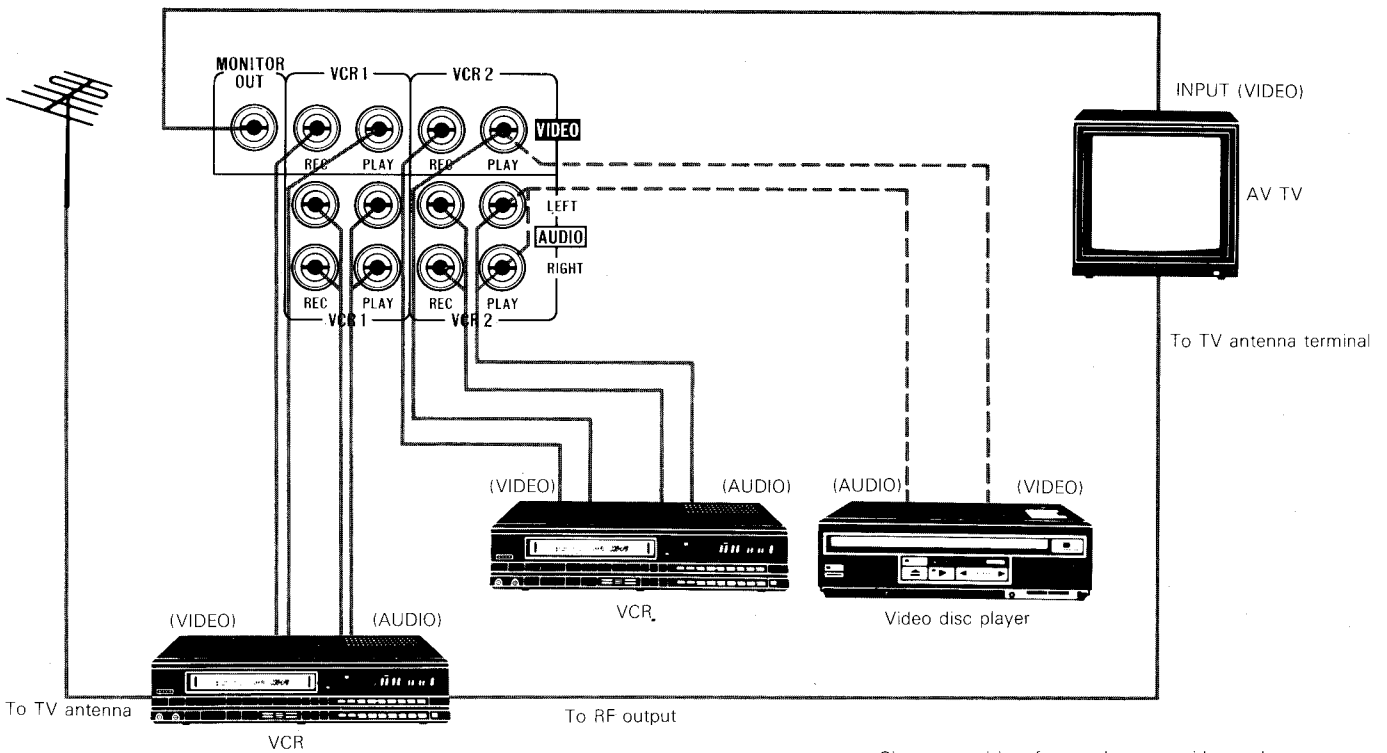

• Since mutual interference between video and audio components can cause noise and distorted pictures, you are recommended to use coaxial cable for the TV/video antenna.

Front Panel

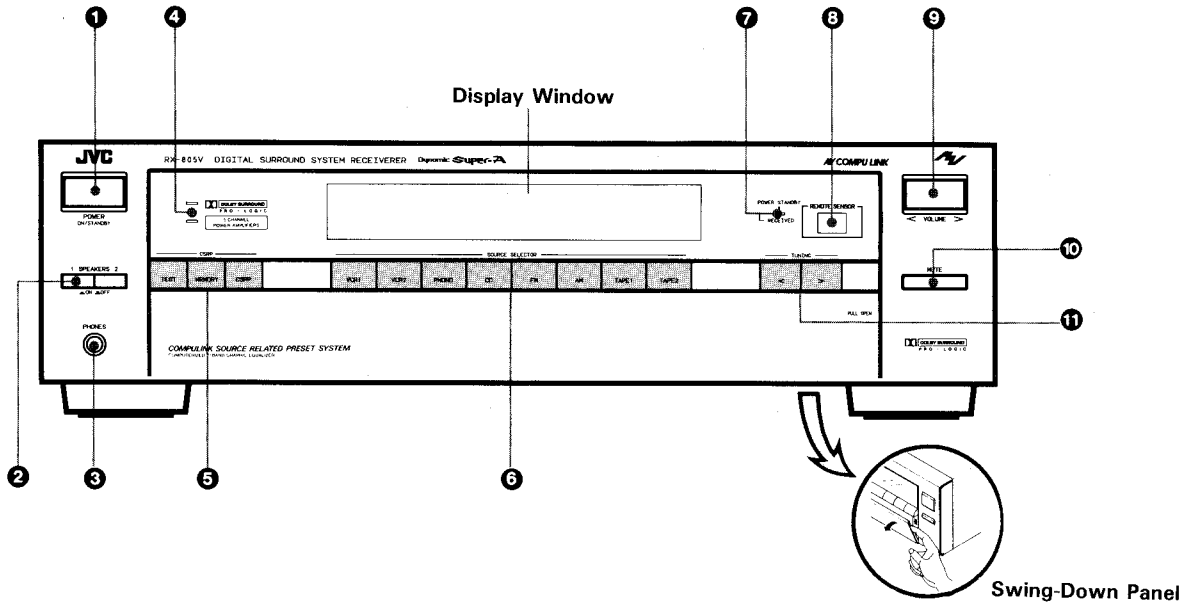

1 POWER (ON/STANDBY)

Press this button to turn the power ON. Press again to turn the power off and activate the STANDBY mode. The STANDBY indicator will light.
A small amount of power (5 watts) is consumed in the STANDBY mode. To turn the power off completely, disconnect the power cord from the wall outlet. Preset data is retained in memory while the power cord is plugged into the wall outlet. If the power cord is disconnected or a power failure occurs, data is retained for two or three days.

2 SPEAKERS 1, 2

Turns speakers 1 and 2 ON or OFF.

3 PHONES

Plug headphones into this jack. If you want to hear from the headphones alone, turn OFF speakers 1 and 2.

4 SURROUND INDICATOR

Lights during surround playback, for surround mode or center channel mode, whichever is selected.

- : When "DOLBY PRO-LOGIC SURROUND" is selected for surround mode
- : When "NORMAL" or "WIDE" is selected for center channel mode

5 CSRP

COMPU LINK SOURCE RELATED PRESET SYSTEM feature

- TEST:** Displays all the CSRP setting data on each source one after another.
- MEMORY:** Stores CSRP data in memory.
- CSRP:** Turn the CSRP feature ON or OFF.

6 SOURCE SELECTOR

- Use the following keys to select to select sources:
- VCR 1
 - VCR 2
 - PHONO
 - CD
 - FM
 - AM
 - TAPE 1
 - TAPE 2
- (alternates between ON and OFF)

7 RECEIVED and POWER STANDBY indicator

Lights when signals are received from the remote control unit or when the machine is in the STANDBY mode.

8 REMOTE SENSOR

Receives signals from the remote control unit.

9 VOLUME < , >

Adjusts the volume of sound from the speakers or headphones.

10 MUTE

Turns sound ON or OFF temporarily.
To release it, press the MUTE key again, or press the VOLUME or BALANCE key.

11 TUNING < , >

Tunes in an AM or FM frequency.

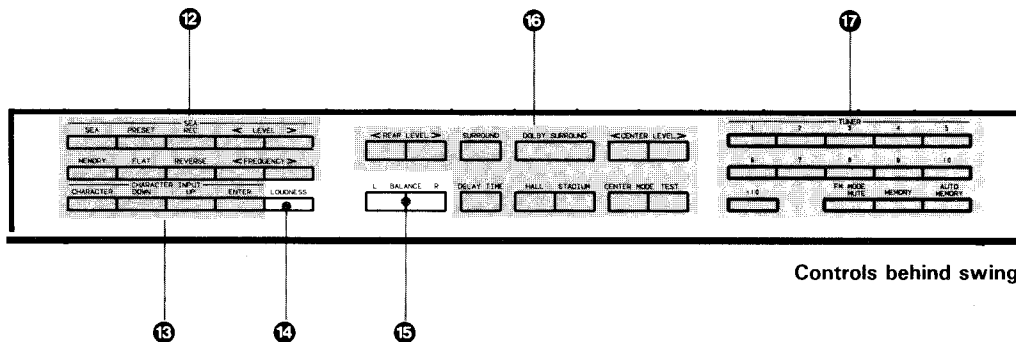

Controls behind swing-down panel.

12 SEA

Use the following keys for the S.E.A. Graphic Equalizer:

- SEA:** Turns the S.E.A. ON or OFF.
- PRESET:** Calls an S.E.A. preset pattern.
- REC:** Turns S.E.A. recording ON or OFF
- LEVEL < , >:** Sets an S.E.A. level.
- MEMORY:** Stores an S.E.A. pattern in memory
- FLAT:** Flattens S.E.A. characteristics
- REVERSE:** Reverses polarity of the S.E.A. characteristics
- FREQUENCY < , >:** Calls a frequency band to correct

13 CHARACTER INPUT

Use the following keys to assign titles or other data to the S.E.A. patterns or to TUNER channels you have preset:

- CHARACTER:** Sets the CHARACTER INPUT mode.
- DOWN, UP:** Press to select characters (letters, numerals, and symbols).
- ENTER:** Stores created titles in memory.

14 LOUDNESS

Turns LOUDNESS ON or OFF. The ON position makes up for loss of the human auditory sensation when the sound volume is low.

15 BALANCE L, R

Adjust the volume balance between the left and right speakers.

16 SURROUND

Use the following keys to playback with surround sound effect.

- SURROUND:** Turns the surround sound effect ON/OFF.
- DOLBY SURROUND**
- HALL**
- STADIUM:** Selects the surround mode.
- CENTER MODE:*** Selects the center channel mode.
- TEST:*** Turns the test tone ON/OFF.
- REAR LEVEL:** Sets the output level of the REAR SPEAKERS.
- CENTER LEVEL:*** Sets the output level of the CENTER SPEAKERS.
- DELAY TIME:** Sets the delay time for the REAR SPEAKERS.

*Use these keys when in the Dolby Pro-Logic Surround mode. They are not functional in HALL or STADIUM mode.

17 TUNER

Use the following keys to AM or FM broadcasts:

- MEMORY:** Stores an AM or FM frequency (station) on a preset channel.
- AUTO MEMORY:** Stores an AM or FM frequency on a preset channel using the AUTO MEMORY feature.
- FM MODE/MUTE:** Selects FM reception modes.
- 1 - 10, + 10**
(Tuner numeric keys): Press to select preset channels.

Remote Control Unit

The remote control unit provided control the receiver and JVC's audio visual gear from a remote place.

- It is programmable, with the ability to learn the functions of most other remote controls for audio and video components, regardless of make.
- It's sequential programming facility lets you assign a sequence of actions to a single key and up to three sequences can be programmed.
- The remote control unit also has two control panels: the external panel has keys for basic operation and easy-to-use multifunction cursor keys, while the internal contains keys for programming.

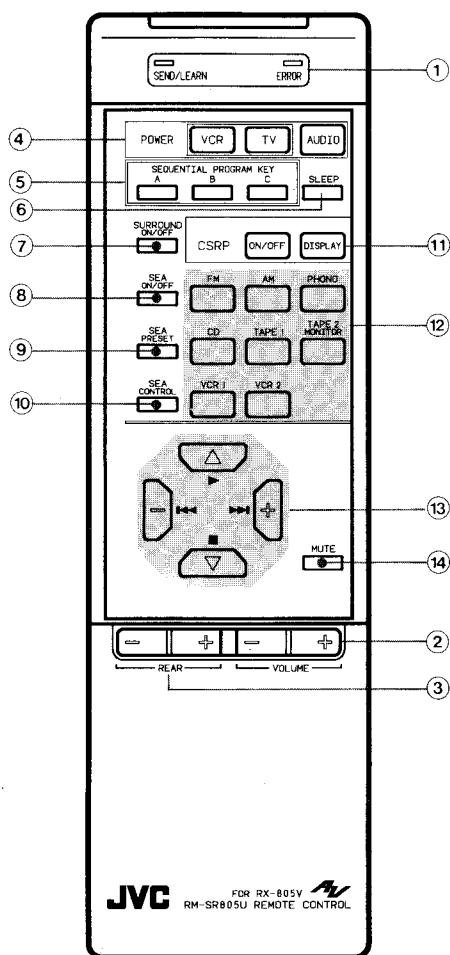

- ① **SEND/LEARN indicator ERROR indicator**
The remote control unit operation statuses are indicated.
- ② **VOLUME (-, +)**
Press to adjust the output sound level.
- ③ **REAR (-, +)**
Press to adjust the output level of the rear speakers.

■ Controls on the External Panel

Contains keys used in basic operations.

- ④ **POWER**
AUDIO: Press to turn the power for the receiver ON or STANDBY.
TV: Press to turn on or off the power to JVC's TV receiver.
VCR: Press to turn on or off the power to JVC's VCR.
- ⑤ **SEQUENTIAL PROGRAM KEY (A, B, C)**
The remote control unit functions can be stored in the desired order for up to 16 individual operations.
- ⑥ **SLEEP**
Use this control when you want to set the Sleep Timer.
- ⑦ **SURROUND ON/OFF**
Turns the surround sound effect ON or OFF.
- ⑧ **SEA ON/OFF**
Turns the S.E.A. feature ON or OFF.
- ⑨ **SEA PRESET**
Calls an S.E.A. preset pattern.
- ⑩ **SEA CONTROL**
Puts the Multi Function Cursor Keys in the S.E.A. mode.
- ⑪ **CSRP ON/OFF:** Turns CSRP ON or OFF.
DISPLAY: Use to display the CSRP settings.
- ⑫ **Source Select keys**
Press to change the source selected for input to the receiver. Different functions are assigned to the Multi Function Cursor Keys depending on the source.
- ⑬ **Multi Function Cursor keys**
Use for basic operations of the source equipment selected with the Source Select keys, and operation of the S.E.A.
- ⑭ **MUTE**
Press to turn the output sound ON or OFF.

■ Controls on the internal Panel

Extra keys on the panel are for the various operations that cannot be done using only the keys on the external panel.

① LEARN, CANCEL

Use to set the operation mode to LEARN or CANCEL.

② Function Select keys

Press to select the function mode of the PROGRAMMABLE CONTROL SECTION keys.

③ PROGRAMMABLE CONTROL SECTION keys

Use to operate equipment connected to the receiver.

Different functions are assigned to these keys by the Function Select keys and Source Select keys.

Other remote control signals can be registered to these keys.

■ Inserting Batteries

Use long-life dry cells, type "AAA" (1.5 V) × 2.

1. Remove the rear cover of the remote control unit by pressing down gently while sliding it out.

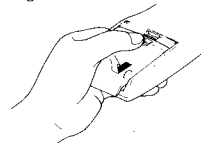

2. Insert the batteries, making sure that their position matches that of the diagram inside the remote.

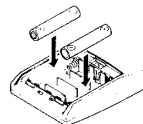

3. Replace the rear cover.

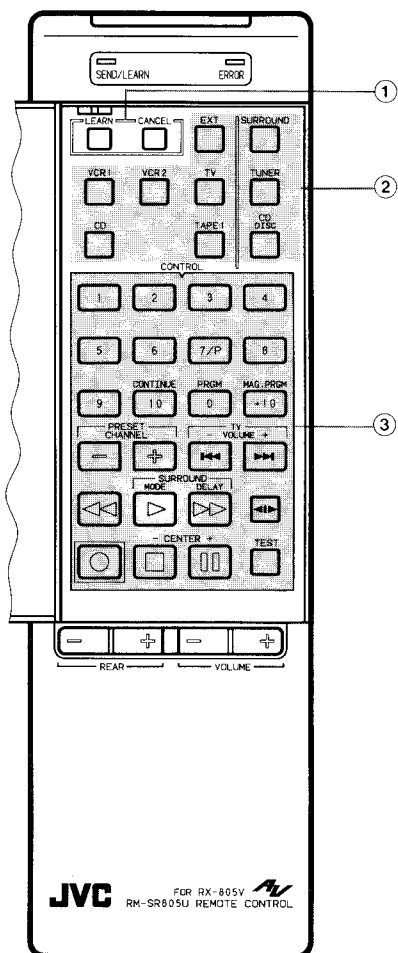
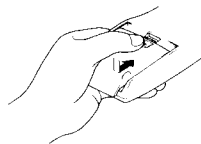

Battery Replacement

- If the range of the remote seems shortened, the batteries may be old. Try replacing the old batteries.
- Do not use a new battery with an old battery.
- Do not allow more than 3 minutes for battery replacement to preserve stored data.
- Use batteries of the same brand. Batteries can vary in voltage even though they look alike.
- If you are not planning to use the remote control for an extended period of time, remove the batteries.

CAUTION:

Do not heat batteries or attempt to dispose of them by burning.

Basic Operation

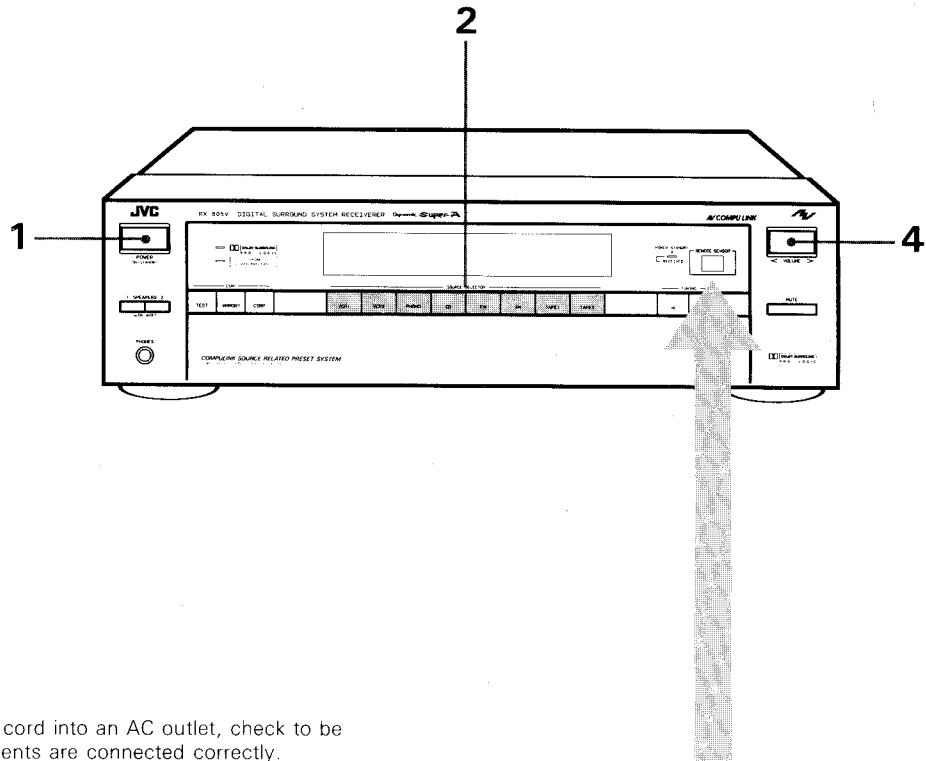

Before Operating:

- Before plugging the power cord into an AC outlet, check to be sure the individual components are connected correctly.
- Point the Remote Control Unit at the REMOTE SENSOR on the target component.
- The range of the remote control is about 23 feet (7 m). Make sure there are no obstacles between your remote and your equipment that may block the signal.
- Use the keys on the external panel of the remote control unit, only when it is firmly closed. You can not operate the keys on the external panel, when it is open.

Notes:

- When operating the component connected by COMPU LINK SYNCHRO-1 remote cable, or operating the TV connected by AV COMPU LINK cable, point the remote at your receiver.
- If a malfunction occurs when the power is ON, unplug the power cord and then plug it in again.

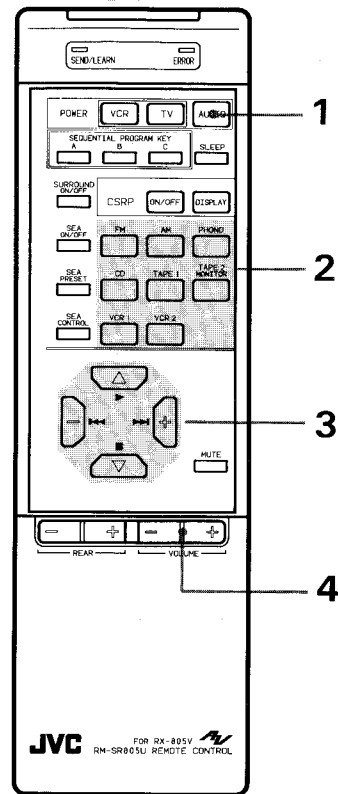

1. Press the POWER key to turn the receiver on.

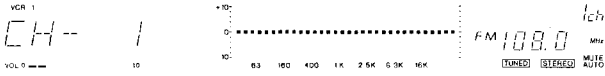
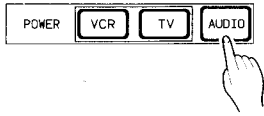

The display window lights up.

2. Press one of the SOURCE SELECTOR keys for the desired source.

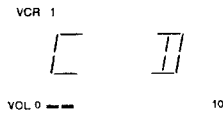

To listen to another audio source while watching VCR 1 or VCR 2:

Press either the VCR 1 or VCR 2 key, and then press the key for the desired audio source.



3. Operate the source components.

- Basic operations for the tuner and source equipment can be done using the Multi Cursor keys. See "Multi Cursor keys" on the right. The Dot Display section in the Display Window shows the input signal levels in each separate audio frequency bands.

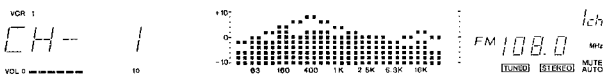

4. Adjust the output sound level using the VOLUME keys.

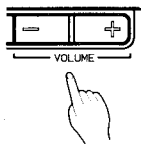

Multi Cursor keys

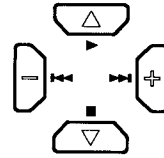

Depending on the source, different functions are assigned to the Multi Cursor keys. You must press the Source Select keys first before use the Multi Cursor keys.

FM, AM mode

- △ : Scans to higher preset channel.
- ▽ : Scans to lower preset channel.

PHONO mode

- ▶ : Starts play.
- : Stops play.

CD mode

- ▶ : Starts play.
- ◀◀ : Skips to the beginning of the previous track.
- ▶▶ : Skips to the beginning of the next track.
- : Stops play.

TAPE 1 mode

- ▶ : Starts playback.
- ◀◀ : Fast winds the tape from right to left.
- ▶▶ : Fast winds the tape from left to right.
- : Stops play.

VCR 1, VCR 2 mode

- ▶ : Starts playback.
- ◀◀ : Rewinds video tape.
- ▶▶ : Fast-forwards video tape.
- : Stops play.

Using the Sleep Timer

The Sleep Timer shuts off the receiver (to enter the STANDBY mode) when the preset time intervals have elapsed.

- Press the SLEEP key on the remote control unit to set the timer setting mode.

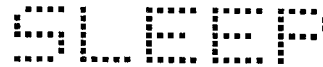

- Each time the SLEEP key pressed subsequently, the timer can be set up to 80 minutes, in 10 minutes multiples.

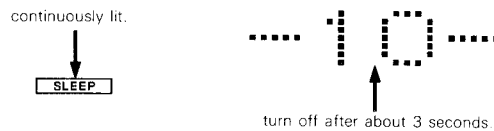

- After the minute display turns off, press the SLEEP key once more to display the remaining time in minutes.

Listening to AM or FM Broadcasts

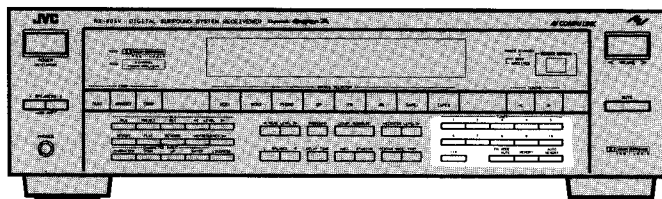

■ Tuning in a Station

1. Press the AM or FM key.

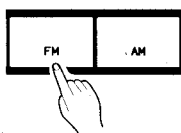

2. Use the TUNING keys to find a station.

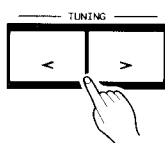

- While tuning in an FM station, press the FM MODE/MUTE key to light the MUTE/AUTO indicator, this cuts out inter station noise while tuning.

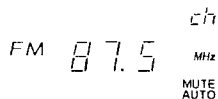

Each time the TUNING keys are pressed, the frequency is varied in steps of 10 kHz for AM and 0.1 MHz for FM. The setting will vary continuously while the keys are pressed and held.

Auto-tuning starts when the TUNING keys are released and stops when a station is tuned. To halt auto-tuning, press a TUNING key.

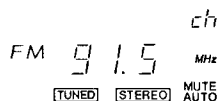

The TUNED indicator will light when a station is tuned in correctly.

- Adjust the antenna if the indicator does not light.
 - The STEREO indicator will light when an FM stereo station is tuned in correctly.
- If the FM stereo station is weak and noisy, press the FM MODE/MUTE key again to turn off the MUTE/AUTO indicator to improve reception (broadcast becomes monaural).

■ Presetting Stations

You can preset a total of 40 AM and FM station (CH 1 through CH 40).

1. Tune in the desired station with the TUNING keys.

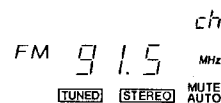

2. Press the MEMORY key to light its indicator.

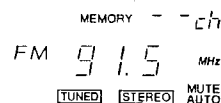
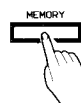

3. Enter the channel number with numeric keys while the indicator is on (for about 5 seconds).

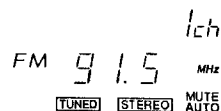
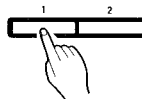

- If the indicator turns off before you enter the channel number, press the MEMORY key again.

4. Repeat this procedure to preset other channels.

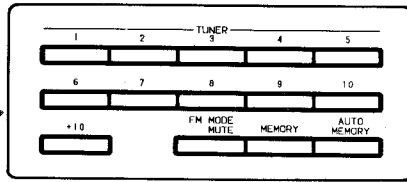

■ Auto Memory

The auto-memory feature scans frequencies upward and presets stations as they are tuned, in ascending channel number order.

- Using the TUNING keys, select the frequency from which you want auto-memory to start (the lower-limit frequency).
- Press the AUTO MEMORY key to light its indicator.

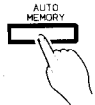

AUTO MEMORY indicator is lit. The display shows 'FM 87.5 MHz' and 'MUTE AUTO'.

Enter the starting channel number with the numeric keys while the indicator is on (about 5 seconds).

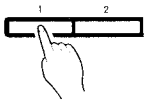

The display shows 'FM 87.5 MHz' and 'MUTE AUTO'. The 'AUTO MEMORY' indicator is still lit.

- If the indicator turns off before you enter the channel number, press the AUTO MEMORY key again.
- The auto-memory feature starts scanning frequencies upward.

The TUNED indicator will light when a station is tuned, with the channel number blinking (for about 5 seconds).

The display shows 'FM 91.5 MHz' and 'MUTE AUTO'. The 'TUNED' and 'STEREO' indicators are lit, and the 'AUTO MEMORY' indicator is still lit.

- The presetting is complete when the MEMORY indicator is lit.

The display shows 'FM 91.5 MHz' and 'MUTE AUTO'. The 'TUNED' and 'STEREO' indicators are lit, and the 'MEMORY' indicator is lit.

This continues until the upper-limit frequency is reached or all 40 channels are filled.

Note:

If you do not want to preset a station, resume scanning by pressing the AUTO MEMORY key while the channel number is blinking. To halt the auto-memory key feature, press any TUNER key other than the AUTO MEMORY key.

■ Selecting preset channels

- Press numeric keys to select a preset channel.

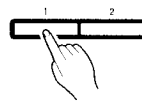

The display shows 'VCR 1', 'CH--', and 'VOL 0'. The channel number '1' is displayed on the right.

- To indicate numbers 1 through 10, simply press the appropriate keys.
- To indicate numbers over 10, press the appropriate combination of keys.

Examples;

To indicate 17, press "+10", then "7".

To indicate 20, press "+10", then "10".

To indicate 26, press "+10" twice, then "6".

To indicate 40, press "+10" three times, then "10".

You can designate the preset channel number using the remote control unit.

- Press the TUNER key of the Function Select keys on the internal panel.
- Use the following keys.

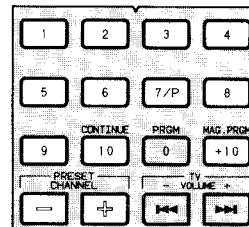

1 ~ 10, + 10 : Enters the preset channel number.
PRESET CHANNEL

- + : Scans to higher preset channels.
- : Scans to lower preset channels.

Using the S.E.A. Graphic Equalizer

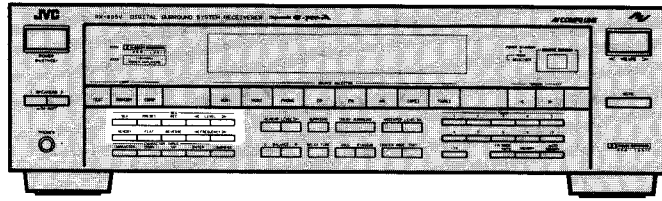

The S.E.A. Graphic Equalizer breaks down the audible frequency range into seven bands. Each band of tones can be adjusted as desired by the listener. Thus allowing you to make the necessary adjustments in the precisely appropriate frequency bands.

- *You can customize the sound to your taste.
- *You can correct subtle frequency to suit the acoustic characteristics of your listening room.
- *You can compensate for the conditions of audio equipment.

Note:
The S.E.A. Graphic Equalizer does not work on the CENTER and REAR speaker sound.

■ Recalling a preset pattern

A total of 10 preset patterns can be used: 5 programmed preset patterns, and 5 manual patterns which you create (SEA-A through E).

1. Press the SEA key.

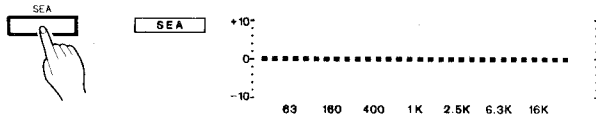

The Dot Display normally shows the input signal levels. It will change to SEA level for about 5 seconds when the SEA, PRESET, LEVEL, FLAT, REVERSE, or FREQUENCY keys are pressed.

2. Call a preset pattern with the PRESET keys.

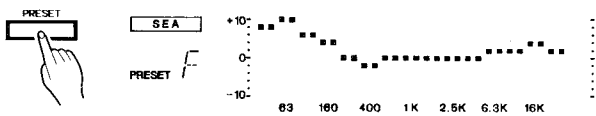

- A—E: Manual patterns
- F) **HEAVY:** For music with a heavy beat.
- G) **CLEAR:** For crisp, clear sound with transparent highs.
- H) **SOFT:** For background music, at low volume level.
- I) **MOVIE:** For TV, VCR, and videodisc sound.
- J) **VOCAL:** For music that is chiefly vocal, or speech.

Order

A ► B ► C ► D ► E ► F ► G ► H ► I ► J ► (back to the beginning)

- After recalling these pattern, you can further change each frequency band to suit yourself. However, since they are representative patterns, the original, stored pattern will be unchanged.

■ Creating an S.E.A. pattern

1. Press the SEA key.
2. Press the FREQUENCY keys to call the desired frequency.

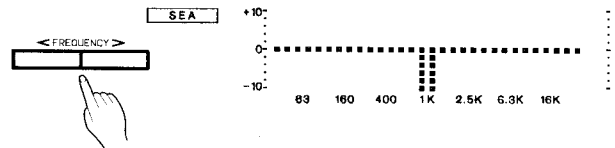

3. Press the LEVEL keys to adjust the S.E.A. level.

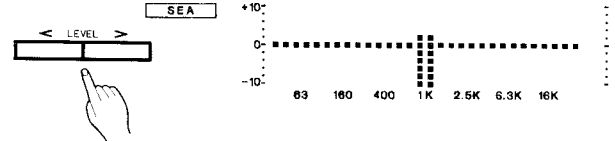

Note:
When a frequency has been called, press the LEVEL keys while the frequency is displayed (about 5 seconds). If the display is cleared before you press the LEVEL keys, it can be recalled by pressing either FREQUENCY keys or LEVEL keys.

- The SEA key enables you to compare the sound corrected by S.E.A. with the original (uncorrected) sound during the procedure for creating an S.E.A. pattern. Pressing the SEA key to turn the S.E.A. OFF lets you hear the uncorrected sound. When you press the S.E.A. key again, the S.E.A. pattern being created is recalled and the corrected sound can be heard.

- To flatten the SEA characteristics.

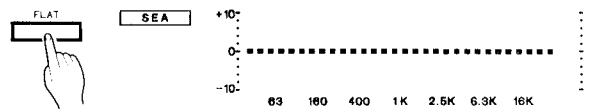

Pressing the FLAT key while a pattern is yet to be preset will clear it. Be careful not to press the FLAT key inadvertently.

- You can create an S.E.A. pattern using the remote control unit.

1. Press the SEA CONTROL key on the external panel.
2. Use the Multi Function Cursor keys.

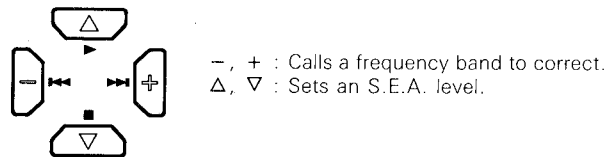

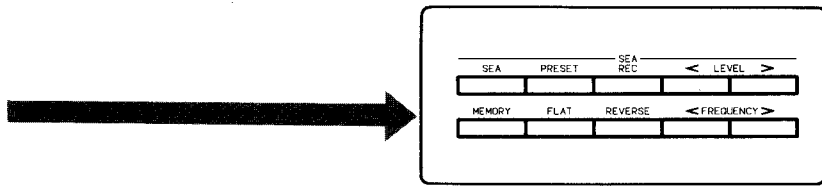

■ Presetting Manual Patterns

1. Create an S.E.A. pattern to preset as instructed in "Creating an S.E.A. pattern".
2. Press MEMORY key to light its indicator. Call one of the patterns to store (SEA-A through E) by pressing the PRESET keys while the indicator is on (about 5 seconds).

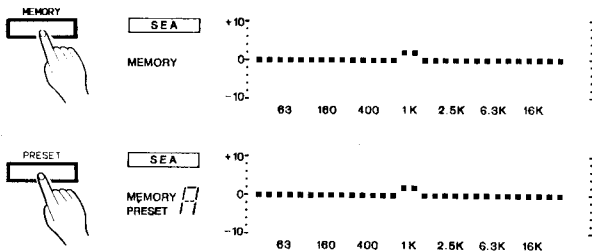

Order
A▶B▶C▶D▶E▶ (back to the beginning)

Note:

Press the MEMORY key again if the indicator turns off before you press the PRESET keys.

3. Press the MEMORY key again while the indicator is on (about 5 seconds). Memory presetting is complete when the MEMORY indicator turns off.

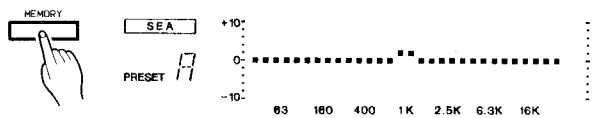

The preset SEA patterns can each be given a five-character title. See the section "Entering Characters" for further details.

■ S.E.A. recording

The sound corrected by S.E.A. can be recorded on the tape deck connected to the TAPE 1 terminals.

1. Press the SEA key to turn the S.E.A. ON.
2. Adjust the S.E.A. settings (PRESET, FREQUENCY, LEVEL)
3. Press the REC key.

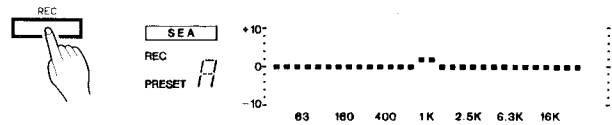

4. Operate the recording procedure.

Notes:

- SEA recording is not available with the tape deck connected to the TAPE 2, VCR 1, and VCR 2 terminals.
- The REC key is not functional when the SURROUND key is ON.

The reverse feature offers you a noise reduction effect during tape recording. First, record sources with emphasis on high-pitched tones by using SEA; during playback, activate reverse SEA, to cut hissing noise inherent in tape recording.

To reverse the polarity of the S.E.A. characteristics, press the REVERSE key.

Frequency band responses

63 Hz: Raise to emphasize the very low base response of organs, drums, and contrabass. When de-emphasized, eliminated unclear response at low frequencies.

160 Hz: Emphasize to obtain a more expanded low sound. De-emphasize to eliminate unclear sound caused by large or nearly empty listening rooms.

400 Hz: This frequency range is the base on which music is constructed. Emphasize to put real punch in your music.

1 kHz: Most effective in emphasizing or de-emphasizing the human voice.

2.5 kHz: The human hearing is most sensitive to this frequency. If the music sounds hard or metallic, de-emphasize it.

6.3 kHz: This frequency band varies the tonal expression, influencing the subtleties of the music.

16 kHz: Boosting this frequency range suitably adds to the delicacy of highs, with cymbals and triangles resounding in a more ear-pleasing manner, and provides a feeling of extension.

Entering Characters

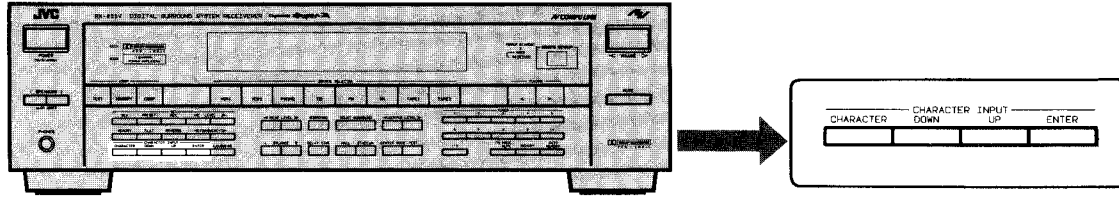

You can name the S.E.A. manual preset patterns (SEA A to E) and the TUNER preset channels (CH 1 to 20) as you wish. Up to five characters can be entered.

1. Specify a S.E.A. manual preset pattern or a TUNER preset channel, then press the CHARACTER key.

<To specify a S.E.A. pattern> Use the S.E.A. PRESET key.
<To specify a Tuner Preset Channel> Use the numeric keys.

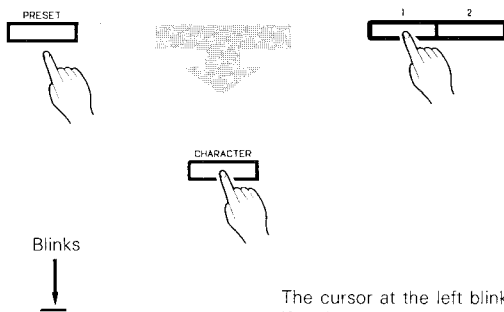

Note:
When a preset S.E.A. pattern has been called, press the CHARACTER key while the pattern is displayed (about 5 seconds). If the display is cleared before you press the CHARACTER key, press the PRESET key.

2. Select the appropriate characters with the UP and DOWN keys.

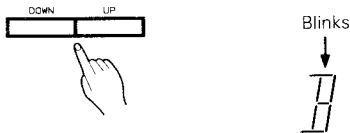

Alphanumeric character order.

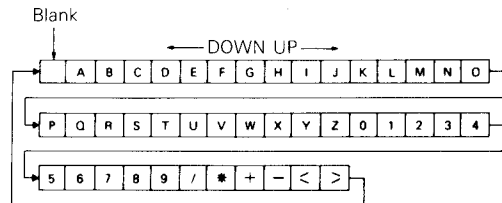

3. Press the CHARACTER key to move to the next position. Repeat steps 2 and 3.

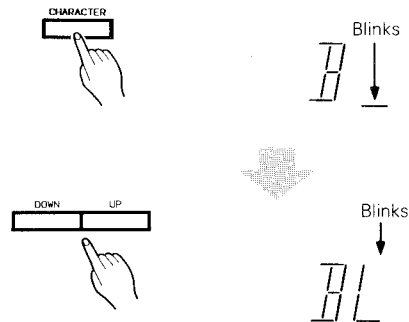

- To alter the characters, move the blinking cursor to the desired character for correction using the CHARACTER key.
4. When the entry is complete, press the ENTER key to store it in memory.

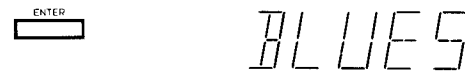

Recording

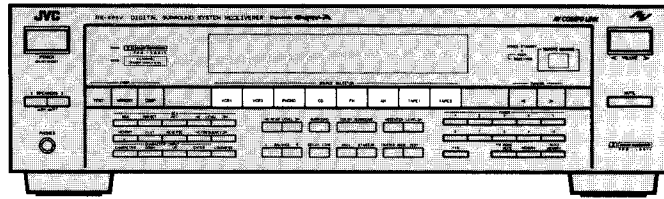

■ Recording

1. Press the SOURCE key for the desired source.
2. Operate the corresponding source equipment.

<If you select PHONO>



Turntable and tape deck can be operated.

Note:

The surround sound is recorded as a normal stereo sound even if it is recorded with the SURROUND key is ON.

■ Three-Head Tape Decks

If you have a three-head tape deck, you can use it to monitor the sound being recorded. Connect the tape deck to the TAPE 2 terminals and proceed as follows:

1. Start recording the source onto the TAPE 2 deck.

When the TAPE 2 MONITOR indicator is off, you hear the sound of the source playing through the speakers.

2. Press the TAPE 2 key.

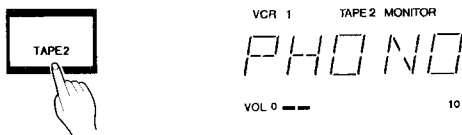

Now you hear the sound of the recording immediately as it is made on the tape.

- By pressing the TAPE 2 key on and off, you can compare the sound quality of the source with the quality of the tape recording being made.

Note:

Set the recording level from the tape deck. It can not be set with the VOLUME control of this machine.

■ Dubbing Tapes

Dubbing can be similarly performed between TAPE 1, TAPE 2, VCR 1 and VCR 2. When dubbing from the TAPE 2 deck to another tape deck, press the TAPE 2 key and the SOURCE key other than the tape deck.

<To record from TAPE 1 to TAPE 2>

1. Press the TAPE 1 key.



2. Play back the TAPE 1 deck and record with the TAPE 2 deck.

<To record from TAPE 2 to TAPE 1>

1. Press the TAPE 2 key and a SOURCE key other than TAPE 1.

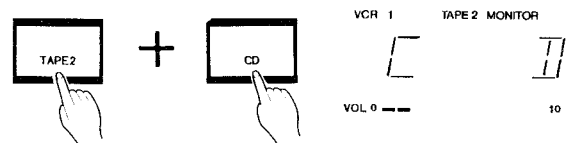

2. Play back the TAPE 2 deck and record with the TAPE 1 deck.

Playing Back with a Surround-sound Effect

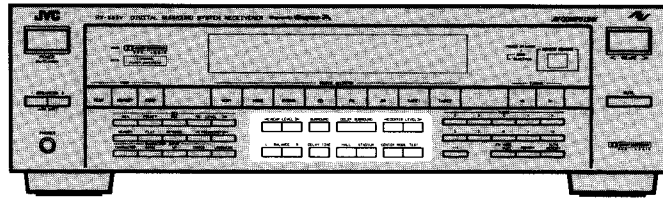

The soundtracks of the video software bearing  mark includes the same encoded surround information as found in the Dolby Stereo films.

As the RX-805VTN incorporates a DOLBY PRO·LOGIC SURROUND decoder circuit, you can get the Dolby Stereo theatre's ambience and effect, when watching these video sources at home.

Dolby Pro Logic Surround decoder provides:

- Four primary sound channels — LEFT, RIGHT, SURROUND and additional CENTER channel.
 - Adaptive Matrix to actively derive each channel.
- The result is that Dolby Pro Logic Surround has the effect of widening the useful listening area and enhancing directional effects.

You can enjoy listening to all Dolby Surround software previously available.

- Select **DOLBY PRO·LOGIC SURROUND** when you use video software with the  mark. For ordinary stereo sources use HALL or STADIUM.

HALL: Produces the expanding surround sound effect such as you would experience in a music hall.

STADIUM: Provides the powerful dynamic surround sound effect of stadium music.

SPEAKER LAYOUT EXAMPLE

- It is recommended that antimagnetic speakers be installed near the TV monitor.
- No output is available from the CENTER SPEAKER terminal when sources are played back in the HALL or STADIUM mode.
- The center speaker is not required if you have selected the PHANTOM mode with the CENTER key.

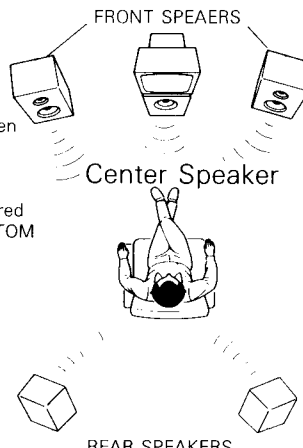

FRONT SPEAERS

Center Speaker

REAR SPEAKERS

1. Set the SURROUND key to ON.



2. Select the Surround mode: DOLBY PRO·LOGIC SURROUND, HALL, or STADIUM.

- To select DOLBY PRO·LOGIC SURROUND, press the DOLBY SURROUND key.

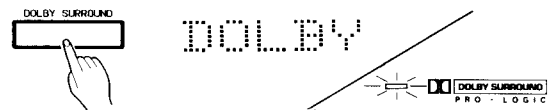

- To select HALL, press the HALL key.

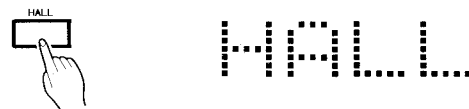

- To select STADIUM, press the STADIUM key.

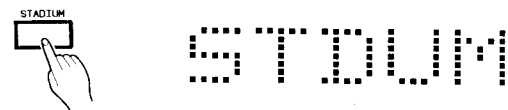

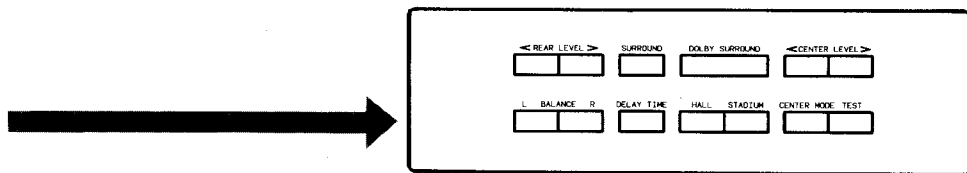

3. Press the CENTER MODE key to select the center channel mode when DOLBY PRO·LOGIC SURROUND is selected.

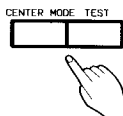

There are four center channel modes:

• **PHANTOM:** PHANTOM

Select this mode when not using the center speaker.

- Center channel signals are distributed between the front left and right speakers with an equal level.

• **NORMAL:** NORMAL

Select this mode when using a compact speaker (which has difficulty reproducing low frequencies) to reproduce center channel signals.

- Center channel signals are reproduced through the center speaker, with low frequencies being cut off.
- Low-frequency center channel signals are reproduced from the front left and right speakers.

• **WIDE:** WIDE

Select this mode when using a speaker similar to the front speakers to reproduce center channel signals.

- Center channel signals are reproduced reproduced through the center speaker as they are.

• **OFF:** OFF

The CENTER channel output can be set to off.

Each time the CENTER MODE key is pressed, the center channel mode changes as follows:

PHANTOM ► NORMAL ► WIDE ► OFF ► (back to the beginning)

4. Playback the source.

Notes:

- The input signal balance is adjusted to be equal automatically by the Auto-Input Balance circuit incorporated in the receiver.
- Playing back with the center channel mode set to "OFF" enables you to check the left and right balance of the signals input to the receiver.
- Even better surround sound effect can be enjoyed by making the adjustment described on the next page.

DOLBY PRO·LOGIC SURROUND 

- Manufactured under license from Dolby Laboratories Licensing Corporation. Additionally licensed under one or more of the following patents: U.S. Numbers 3,632,886, 3,746,792 and 3,959,590; Canadian Numbers 1,004,603 and 1,037,877. "DOLBY" and double D symbol  are trademarks of Dolby Laboratories Licensing Corporation.

■ Adjustment

Make the following adjustment to get maximum out of the surround sound effect.

There are two items to be adjusted.

- Output Level balance
- Delay Time

Adjusting the output level balance

1. Select the DOLBY PRO·LOGIC SURROUND mode with DOLBY SURROUND key.
2. Press the TEST key to turn the test tone ON.

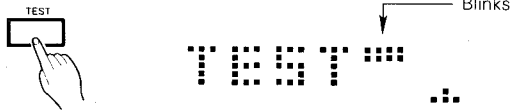

The channel from which the test tone is being output is displayed.

3. You can hear the test tone clockwise through left-center-right-surround repeatedly.
Adjust the test tone to the same level with the REAR LEVEL keys and CENTER LEVEL key.



You can set the rear level and the center level up to ± 20 dB.

Notes:

- Center level adjustment is not required if the PHANTOM mode has been selected.

Adjusting the Delay Time

Set the Delay Time for the rear speaker sound with respect to the front speaker sound using the DELAY TIME key.

Each time you press the key, the delay time changes in the following order:

1 ► 2 ► 3 ► (back to the beginning)

Setting advice:

Compare the distances between the front speakers and the listener and the rear speakers and the listener.

If the position of the rear speakers, compared to the front speakers, is

very far —————► set 1

about the same —————► set 2

very close —————► set 3

Note:

The Delay Time is stored in each mode until you make another change.

- Adjustment will be made easier by using the remote control unit.

1. Press the SURROUND key of the Function Select key on the internal panel.

2. Use the following keys.

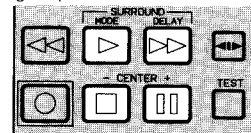

- MODE** : Selects the Surround mode.
DELAY : Sets the Delay Time for the rear speaker sound.
CENTER - , + : Sets the output level of the center channel.

Running the CSRP (Compu Link Source Related Preset System) Feature

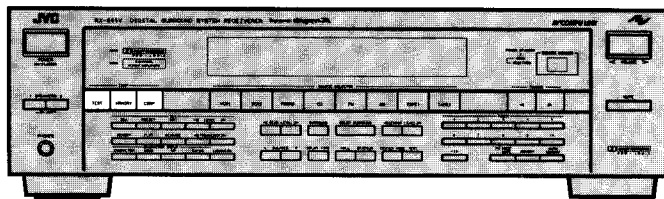

CSRP is the state-of-the-art electronic feature that presets volume, balance, and other control settings. This was previously done manually each time a different source was played back. This feature lets you invoke preset control settings by simply pressing a SOURCE key or calling up a TUNER preset channel without repeating many settings each time surces are changed.

The following controls can be preset on each SOURCE key (except TAPE 2) or TUNER preset channel (CH-1 through CH-10)

- | | |
|----------------|---------------------|
| • VOLUME | • SURROUND |
| • BALANCE | ON/OFF |
| • LOUDNESS | Surround Mode |
| • S.E.A. | Center Channel Mode |
| ON/OFF | Rear Level |
| Preset Pattern | Center Level |
| | Delay Time |

When the CSRP key is turned ON the display will show the date settings on the currently selected SOURCE key or TUNER preset channel in sequence with the indicator blinking rapidly. Subsequently, a similar display occurs each time an additional source is selected.

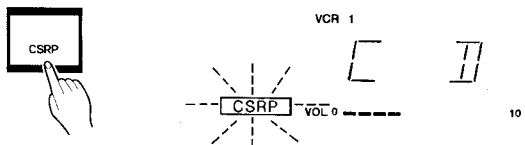

Note:

The current preset data is displayed in sequence when the power is turned on with the CSRP ON.

To confirm the settings presetted in the current source

Press the CSRP DISPLAY button on the remote control unit. This operation does not turn on or off CSRP.

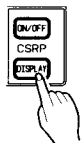

Presetting Procedure

- Before proceeding, set the preset state.
1. Press the MEMORY key to blink the CSRP indicator.

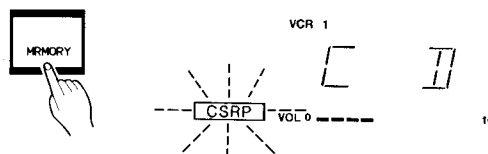

2. Press either the SOURCE SELECT key or call up the tuner preset channel using TUNER numeric keys while the CSRP indicator is blinking (about 5 seconds).

When the presetting is complete, the display will show preset data in the following order with the indicator blinking rapidly:

Note:

Press the MEMORY key again if the indicator stops blinking before you press a SOURCE SELECTOR key. Even with the SEA key ON, the SEA PRESET indicator will blink when the MEMORY key is pressed if an S.E.A. preset pattern has not been previously selected. In this case, select an S.E.A. preset pattern and retry this operation.

■ CSRP TEST

When the TEST key is pressed, all the CSRP data on each SOURCE SELECTOR key (except TAPE 2) or tuner preset channel are displayed in the following order.

→VCR1 ► VCR2 ► PHONO ► CD ► FM ► AM ► TAPE1←

For FM and AM, the last selected preset channel is recalled.

Notes:

- Sound and image output is suppressed while a CSRP test is in progress.
- All other operations are disabled while a CSRP test is in progress.

To exit from this mode, press the TEST key again.

COMPU LINK Remote Control System

- For audio terminal connections, see "Audio Component Connections".

COMPU LINK Remote Control System

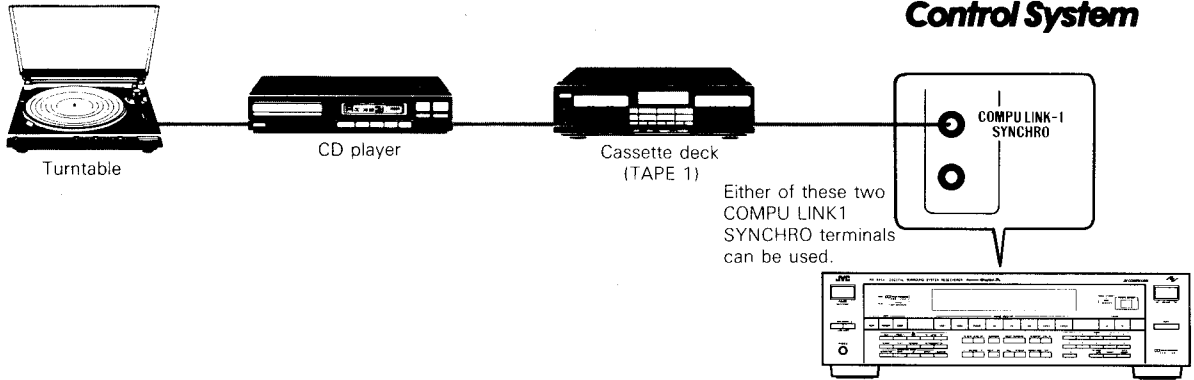

JVC's exclusive "COMPU LINK" remote control system connects equipment with JVC COMPU LINK-1/SYNCHRO terminals to the remote control system. The equipment can be controlled from the remote control unit, or other functions (such as automatic source selection and synchronized recording) can be used. For further details, see the remote control unit description in this instructions.

■ Equipment remote control

By connecting the COMPU LINK-1 SYNCHRO terminal to the receiver, the equipment that does not have REMOTE SENSOR in its main unit can be remote controlled via REMOTE SENSOR of the receiver. For further details, see the remote control unit description in this instructions.

■ Automatic source selection

Pressing SOURCE keys will automatically put the corresponding source equipment into the PLAY mode. When the PLAY key on source equipment is pressed, the corresponding SOURCE key is automatically set to that source. Other source equipment shuts down about 5 seconds later.

■ Synchronized recording

Synchronized recording permits a tape deck to start recording automatically in synchronism with a CD player or turntable. Set the tape deck in the REC/PAUSE mode and press the PLAY key on the CD player or turntable. The tape deck will enter the recording mode automatically, starting synchronized recording.

Synchronized recording stops automatically after the CD player or turntable has stopped and the tape deck has entered the REC/MUTE mode for about 4 seconds. For details, refer to the tape deck instructions.

- To set the REC/PAUSE mode, press the REC and the PAUSE key at the same time. Synchronized recording is disabled if the PAUSE key is pressed after the REC and the PLAY key are pressed Simultaneously. For details refer to the tape deck instructions.

Notes:

- COMPU LINK remote control does not work on the tape deck connected to the TAPE 2 terminals. If you connect a tape deck to the TAPE 2 terminals, disconnect the remote control cable.
- If the power for any connected equipment is shut off during synchronized recording, the system will not operate properly. In this case, you must start all over again.
- During synchronized recording the SOURCE key will lock in either the CD or PHONO position. This is to prevent you from accidentally stopping the recording or changing to any other source. To change to another source you must first stop synchronized recording.
- If you program track numbers on a CD player or CD auto-changer and use synchronized recording, a blank space about 4 seconds long will be left between recordings. This permits music scanning.

Display examples

When using the remote control unit to operate equipment which has the COMPU LINK-1/SYNCHRO terminals, the name of the source and the operating mode will appear on the display.

Symbol	
Indication	
"REC/PAUSE" mode	REC
"REC/PLAY" mode	REC

AV COMPU LINK System

AV COMPU LINK

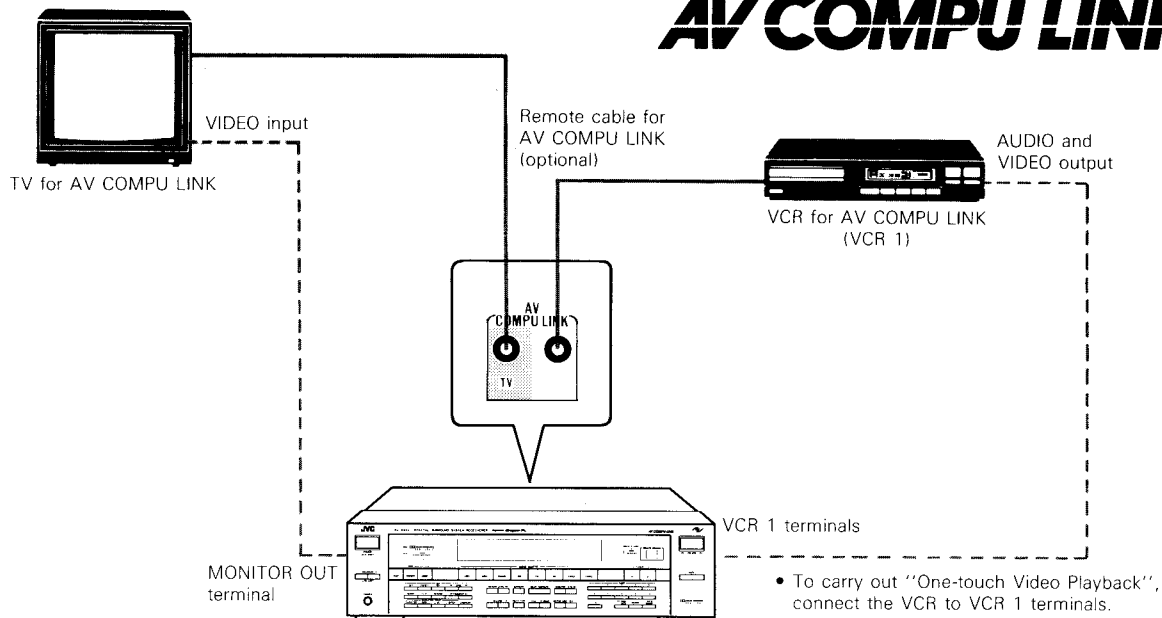

Connecting the AV COMPU LINK terminals on the rear panel to a JVC video components for AV COMPU LINK will enable one-touch control of the integrated audio/video system.

One-touch Video Playback

Insert an overwrite-protected video tape in the VCR (VCR 1).

The TV, VCR, and the receiver turn on, and the video tape plays back automatically.

- When playing back a video tape that is not overwrite protected or there is already a video tape inside the VCR, press "PLAY" on the VCR.
- The input source selectors of the TV and receiver are automatically selected.

This means that simply loading a tape prepares everything needed to enjoy videos on your integrated audio/video system.

When you switch the SOURCE SELECTOR of the receiver to VCR 1 or VCR 2, the TV input will also automatically be set to VIDEO.

Notes:

- The AV COMPU LINK terminals and the COMPU LINK-1 SYNCHRO terminals are not the same jack.
- If the AV COMPU LINK terminals and the SWAP terminal of the VCR share the same terminal for connection, select whichever one you need.
- The AV COMPU LINK terminals must not be connected to any VCR not made for AV COMPU LINK (whether manufactured by JVC or not.)
The AV COMPU LINK terminals of the receiver has two jacks. The jack marked TV must be connected to TV.
- For connection, use the shielded audio cable with monaural mini plug (3.5 mm ϕ) equivalent to the remote cable for COMPU LINK-1 SYNCHRO.
- When operating the TV by remote control, point the remote control unit at the REMOTE SENSOR of the receiver.
(When a remote cable is connected to the AV COMPU LINK terminals of the TV, REMOTE SENSOR of the TV is disabled.)
- When operating the VCR by remote control,
 1. If the VCR has a remote control code switch, set the switch to the "A" mode.
 2. Point the remote control unit directly at the VCR.

Operating the Source Equipment

By using the keys on the internal panel, you can operate the source equipment.

- When using a JVC product
 - Use as is.
- When using a non-JVC product
 - Use after registering the remote control signals for the corresponding source equipment.

Note:

Pressing the Function Select keys will change the function mode of the PROGRAMMABLE CONTROL SECTION keys on the internal panel and the Multi Function Cursor keys on the external panel at the same time.

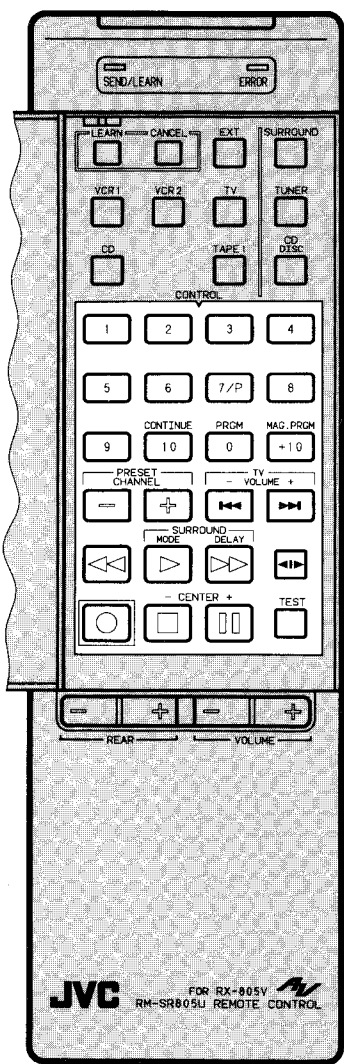

VCR 1, VCR 2

1. Press the VCR 1 or VCR 2 key of the Function Select keys.
2. Use the PROGRAMMABLE CONTROL SECTION keys.

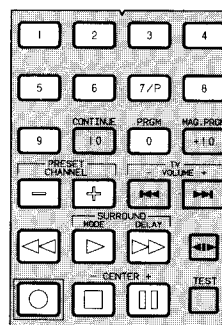

- 1 ~ 9, 0 :** Select the VCR channel directly.
- : Scans to lower VCR channels.
 - + : Scans to higher VCR channels.
 - ▷ : Starts play back a video tape.
 - ◻ : Stops VCR operation.
 - ⏸ : Stops recording/playback temporarily and enters the pause/still mode. To release it press "▷".
 - : Press together with "▷" to start recording. Press together with "◻" to enter the record-standby mode. (Even when a remote controller signals is programmed in "▷" or "◻", this recording feature remains effective.)
 - ◀◀ : Rewinds video tape.
 - ▶▶ : Fast-forwards video tape.

- Some JVC VCRs provide two types of remote control signals (A/B mode selectable). With these VCRs, "A" mode corresponds to the VCR1 mode, and "B" mode corresponds to the VCR2 mode on this remote control unit. If the VCR is connected with the AV COMPU LINK terminal, set the remote control code switch of the VCR to the "A" mode. For details, refer to the Instruction Book of the VCR.

CD

1. Press the CD key of the Function Select keys.
2. Use the PROGRAMMABLE CONTROL SECTION keys.

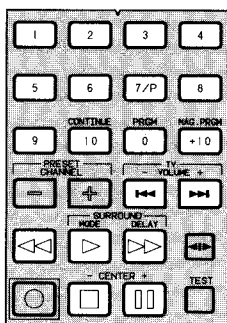

- 1 ~ 10, + 10, 0** : Select the track number.
- : Starts play.
 - : Stops operation.
 - : Stops play temporarily. To release it, press "".
 - : Moves backward quickly during play.
 - : Moves forward quickly during play.
 - : Skips to the beginning of the previous track.
 - : Skips to the beginning of the next track.

Cassette Deck (TAPE 1)

1. Press the TAPE 1 key of the Function Select keys.
2. Use the PROGRAMMABLE CONTROL SECTION keys.

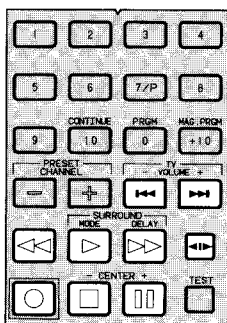

- : Change the tape running direction.
 - : Starts playback.
 - : Stops operation.
 - : Stops recording/playback temporarily. To release press "".
 - : Fast winds the tape from right to left.
 - : Fast winds the tape from left to right.
 - : Skips to the beginning of the previous tune.
 - : Skips to the beginning of the next tune.
 - : Press together with "" to start recording. Press together with "" to enter record-pause mode.
- (Even when a remote controller signals is programmed in "" or "", this recording feature remains effective.)

CD Auto-changer

1. Press the CD DISK key of the Function Select keys.
2. Use the PROGRAMMABLE CONTROL SECTION keys.

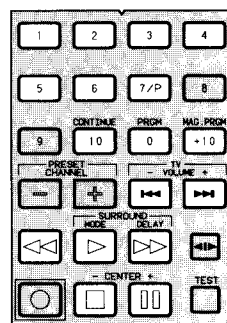

- 1 ~ 6, 7/P** : Selects the disc number
- CONTINUE** : Use for continuous play.
- PRGM** : Use for program play.
- MAG.PRGM** : Use for magazine program play.
- : Starts play.
 - : Stops operation.
 - : Stops play temporarily. To release press "".
 - : Moves backward quickly during play.
 - : Moves forward quickly during play.
 - : Skips to the beginning of the previous track.
 - : Skips to the beginning of the next track.

- To select track numbers, press the CD key before using keys 1 to 10, + 10, and 0 key to enter the track number.

TV

1. Press the TV key of the Function Select keys.
2. Use the PROGRAMMABLE CONTROL SECTION keys.

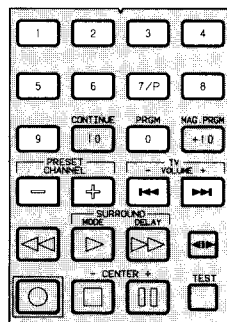

- 1 ~ 9, 0** : Selects the TV channel.
- : Scans to lower TV channels.
 - + : Scans to higher TV channels.
- TV VOLUME** : Adjust the sound volume of TV.
- , + : Adjust the sound volume of TV.

- TV key also change the input mode of the TV between TV and VIDEO.

■ Storing the Signals of Another Remote Control Unit

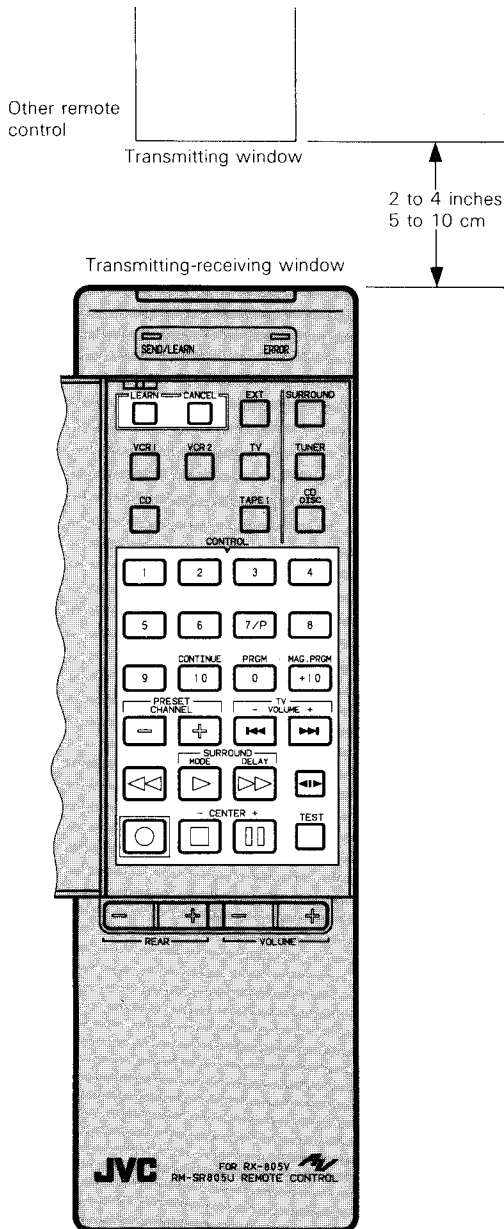

- Signals of other remote controls can be stored with the PROGRAMMABLE CONTROL SECTION keys and POWER (TV or VCR) key. You can control the JVC audio, video, and other remote controllable equipment directly from the remote control unit.
- You can program different signals for the source units selected with the Equipment Select keys in the PROGRAMMABLE CONTROL SECTION keys.
- Place both remote control units on a flat surface. Be sure that the transmitter window of the other remote control unit is about 2~4 inches (5~10 cm) from the transmitting-receiving window. If the units are too close or too far apart, signals may not be stored properly.

1. Press the LEARN key to set this remote control unit to LEARN mode.

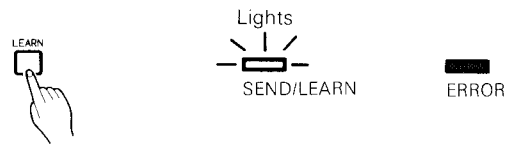

Be sure not to press the LEARN key strongly with a pointed article such as a ballpoint pen, otherwise the VCR may be damaged.

2. Select the function mode required to be programmed with any of the Function Select keys.

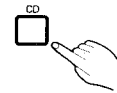

3. Press the desired key for memorizing.

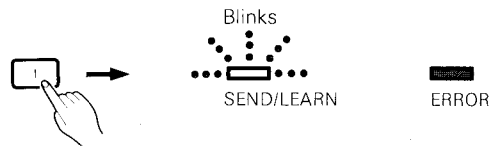

Continue pressing the key until the SEND/LEARN indicator begins to blink.

- If the ERROR indicator lights when the SEND/LEARN indicator is blinking, the key you pressed already has a function stored in it. If you continue with the storing procedure, the previously stored information will be cleared and the new information will be stored instead. If you want to keep the previously stored information, select another learning key and press it.

4. While the SEND/LEARN indicator is still blinking, press continuously the key you want to learn on the other remote control unit.
- If the SEND/LEARN indicator stops blinking before you press the key on the other remote control unit, begin again from step 3.

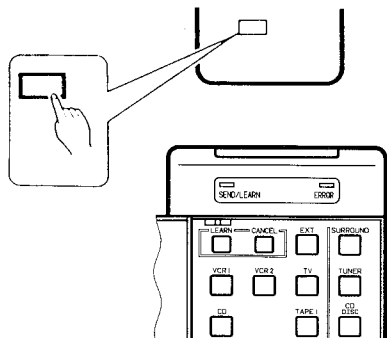

Press the key.



OFF OFF (Reading)
SEND/LEARN ERROR

Lights Lights (Processing)

Lights OFF (Processing normally)

Keep pressing.

- If the ERROR indicator lights, learning operation has not been performed correctly. Repeat the programming procedure again.
- If the ERROR indicator blinks, it means that further programming is inhibited. If you want to program a new signal in a key, cancel the signal preprogrammed in that key before retrying the programming operation.

OFF OFF (Completed)



Release the key.

5. When programming is completed, the SEND/LEARN indicator goes off.
6. Press the LEARN key to reset the remote control unit to USE mode.

IMPORTANT

- This unit can learn almost any remote control signal if the other unit is an infra-red type remote control unit. However, it may not be able to learn special signals or very long signals. (If you repeat the learning procedure several times and the unit still does not operate properly, it may be due to this kind of problem.)
- Some remote control transmit a number of instructions simultaneously (when programming the timer of a TV/VCR, for example); in such a case, the unit may not operate correctly.
- When you use the Recording function, be sure you do not accidentally erase something already recorded on the tape.
- Even when the programming operation has been performed without any problem, the key may not operate or subsequent operation may not be possible. This is because some components may not accept remote control signals which are slightly different from the original ones. If this happens, cancel the previously stored signals then perform the learning operation again. (To cancel the stored signal, refer to the section "How to cancel programmed signals")
- For operations which require pressing two keys together, you must store both functions in the same key by pressing both function keys together on the other remote control unit.
- When batteries in the other remote control unit are exhausted, signals may not be stored properly.

■ Simplifying storage operation

Functions of this remote control unit (preset or newly programmed) can be stored in the desired order with the SEQUENTIAL PROGRAM KEY (A, B, and C) for individual operations, preferably for frequently used operations. The simplified operation can be performed by pressing the SEQUENTIAL PROGRAM keys.

1. Press the LEARN key.
2. Press the selected SEQUENTIAL PROGRAM key (A, B, C).

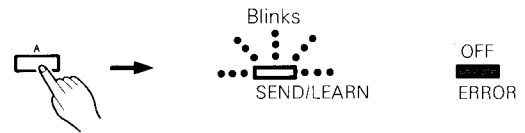

- If the ERROR indicator lights when the SEND/LEARN indicator is blinking, it means that an operation procedure already been programmed in that key. If you proceed, a new procedure appended to the procedure programmed in the key. To program a new procedure in the key, cancel the preprogrammed procedure first. Refer to the section "How to cancel programmed signals."
- If only the ERROR indicator lights, incorrect operation is assumed.

3. Store operations one by one.

<For example: Program the operation for turning on the power to the receiver to play a CD>

- Press the POWER (AUDIO) key while the SEND/LEARN indicator is blinking.
- If the SEND/LEARN indicator stops blinking before you press the key, start again at step 3.

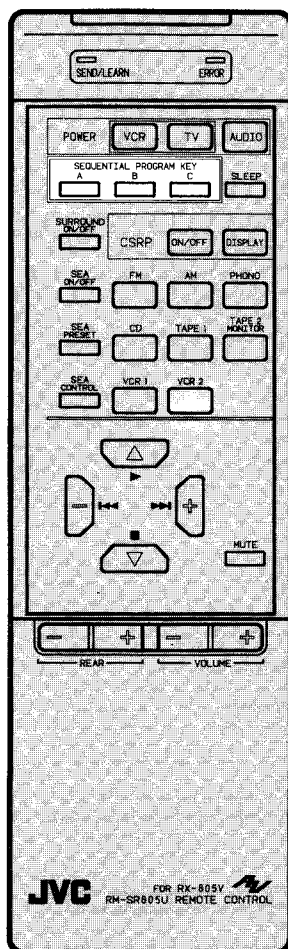

Press the key.

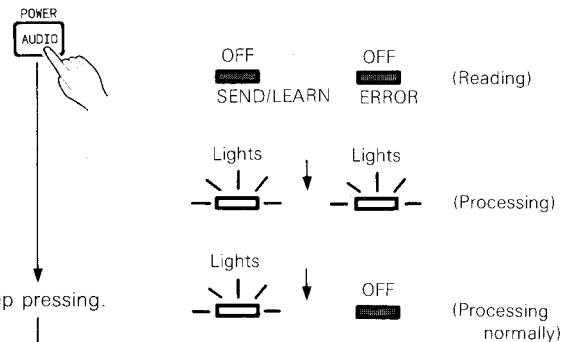

Keep pressing.

If the ERROR indicator blinks, it means that further programming is inhibited. If you want to program a new signal in a key, cancel the signal preprogrammed in that key before retrying the programming operation.

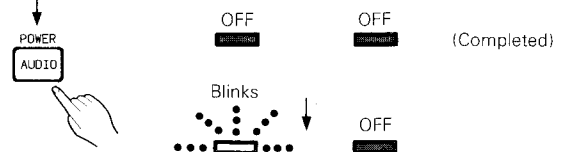

Release the key.

5. Press the CD key of the Source Select keys while the SEND/LEARN indicator is blinking.

Press the key.

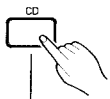

Keep pressing.

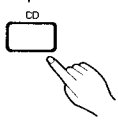

Release the key.

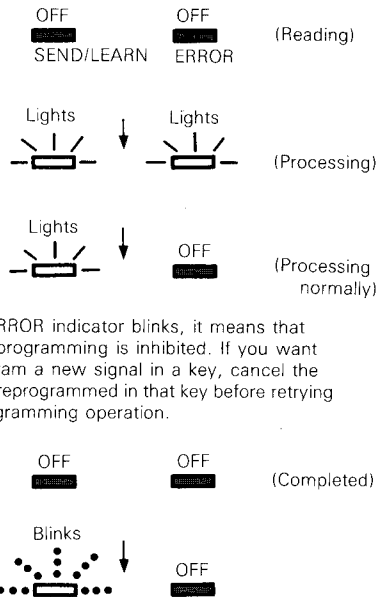

If the ERROR indicator blinks, it means that further programming is inhibited. If you want to program a new signal in a key, cancel the signal preprogrammed in that key before retrying the programming operation.

- The indicator lights or blinks each time operations are stored. Pay attention to the indicator for correct processing. Up to 16 steps can be stored for each combination of key and mode.

6. Press the  key while the SEND/LEARN indicator is blinking.

7. Press the LEARN key again to set the remote control unit to USE mode.

Notes:

- Two keys cannot be pressed together, for example, REC + PLAY or REC + PAUSE.
- The SEQUENTIAL PROGRAM KEYS (A, B, and C) and the mode (1 and 2) allow you to program up to six operation procedures, each consisting of up to 16 steps. Depending on the type of signal to be programmed, not all these steps may not be programmed. If the ERROR indicator blinks three times during a programming operation, it means that further programming is inhibited.

When programming a sequence of operations to control TV, do not bring an operation of selecting a channel or adjusting volume immediately after an operation of turning on power. Otherwise, the stored operations may not be reproduced as programmed.

(This is because some TVs do not immediately become ready to be controlled when turned on.)

Insert two or three operations not related to TV (e.g. operations to control VCR) between an operation of turning the TV power on and an operation of selecting a channel or any other operation to control TV.

■ How to cancel programmed signals

Canceling all the signals stored for a mode of the PROGRAMMABLE CONTROL SECTION keys, or canceling the operation procedure stored with the SEQUENTIAL PROGRAM keys.

1. Press the LEARN key.

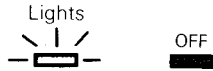
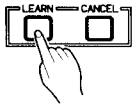

2. Press the CANCEL key.

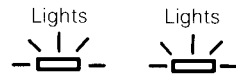
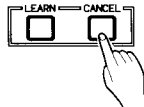

Press the desired key for cancellation.

Press the key

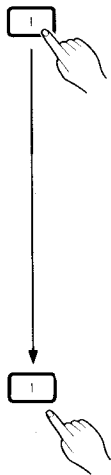

The ERROR indicator lights when there is no signal to be canceled.



Canceling completed.

Release the key.

- When cancelling is completed, the remote controller exits from CANCEL mode, and enters the LEARN mode.

3. Press the LEARN key.

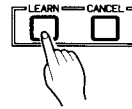

This resets the Remote Control unit to the USE mode.

- If you cancel a signal programmed in a key having a signal preset, the key will be reset to the preset signal and further cancellation is inhibited.

Notes:

- NEVER REMOVE THE BATTERIES while a canceling operation is in progress. If normal operation is not possible even when, having removed the batteries by mistake, they have been reinstalled, remove the batteries and leave the RM-SR903U for about 12 hours. In this case, normal operation will be restored but all the stored data will be cancelled and will be have to perform programming operations again.

PROGRAMMABLE CONTROL SECTION

Other remote control signals for each equipment can be memorized with the PROGRAMMABLE CONTROL SECTION keys. (Use the Function Select keys for switching the functions.)
Complete the following columns with the memorized signals:

VCR 1

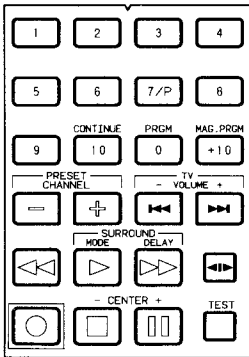

CD

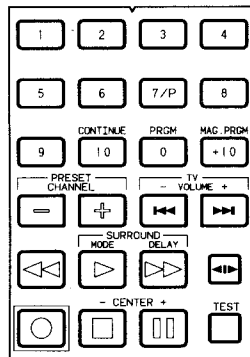

VCR 2

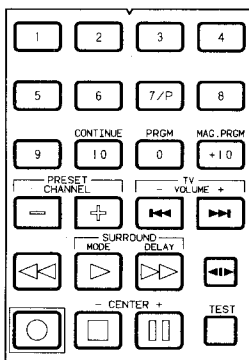

TAPE 1

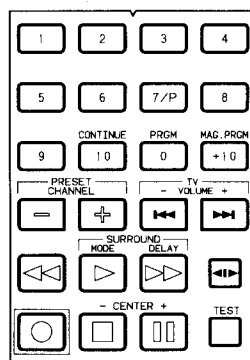

TV

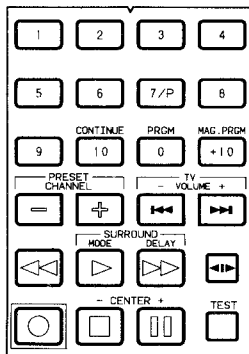

EXT

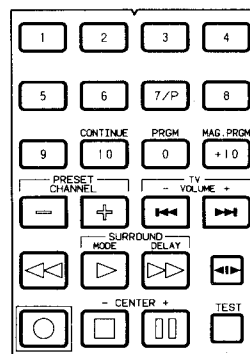

Troubleshooting

Problem	Possible Cause	Solutions
Receiver does not play; Indicators do not light up.	Power cord not plugged in.	Plug Power cord into an AC outlet.
No sound from the speakers.	Speaker wires not connected properly.	Check speaker wiring. Reconnect if needed.
	SPEAKERS keys not set correctly.	Press the SPEAKERS keys in or out as desired.
Sound from one speaker only.	Speaker wires not connected properly.	Check speaker wiring. Reconnect if needed.
	Balance Control may be set to one extreme.	Adjust Balance Control so both speakers have sound.
Continuous hiss or buzzing during FM reception.	Incoming signal may be too weak.	Adjust antenna. Station may be too far away to receive.
	Incorrect antenna used.	Check with your dealer to make sure you are using the correct type of antenna.
	Antenna not connected properly.	Make sure all antennas are properly connected.
	Ignition noise from automobiles.	Move the antenna further away from the road.
Loud hum during record playing.	Turntable not connected properly.	Check the turntable manual. Ground the turntable if required.
	Interference from other electrical appliances.	Try moving the power cord or plugging into a different outlet.
Howling during record playing.	Turntable too close to a speaker.	Move speakers away from the turntable.

Technical Explanation

■ AV Compu Link

1. Description

AV Compu Link is a system to simplify A/V equipment operation that has been complicated and troublesome with systematization of A/V components.

Take note that AV Compu Link system is different from conventional "COMPU LINK-1" and "AV control" systems employed in some of video equipment. So, do not use "COMPU LINK-1 SYNCHRO" terminal and ordinary AV control terminals for connection.

2. Signal of AV Compu Link

(1) Status information (new format)

RX-805VTN/VLTN receives necessary data about change in state from VTR as input of status information.

Input data is composed of 8 bits of which upper 3 bits are for equipment code and lower 5 bits are for status information.

On the other hand, RX-805VTN/VLTN outputs command data to VTR and TV through remote control cord (JVC standard).

(2) Specifications of status signal

See the figures below.

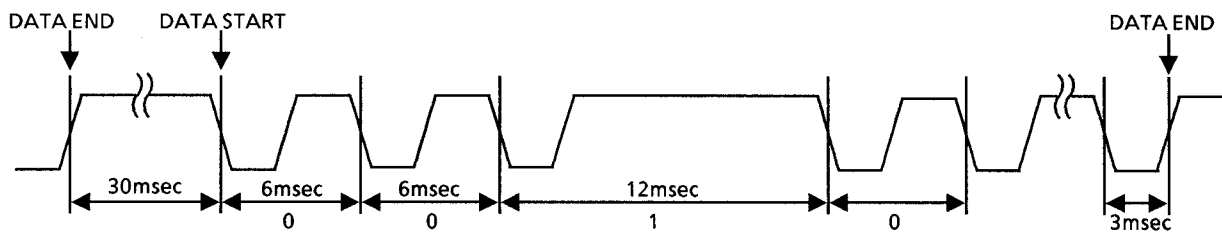

Input signal to RX-805VTN/VLTN

- 1) Transmission of new data is started (DATA START) more than 30 msec after the rise of previous DATA END.
- 2) Data 0 : 6 msec
Data 1 : 12 msec
- 3) End of data (DATA END) is at the rise of the 9th pulse.

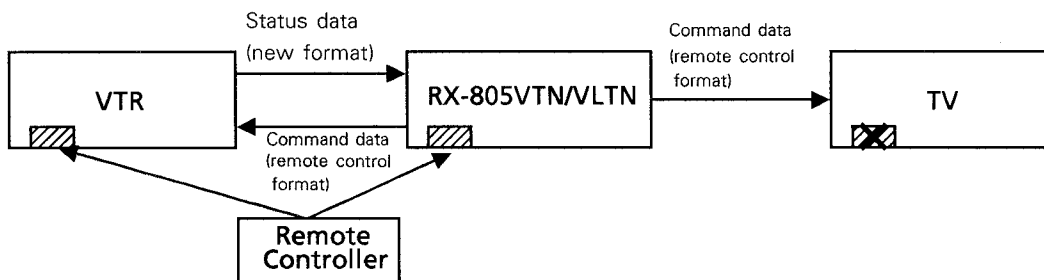

Note : Take note that TV's remote sensor is inactivated when the AV Compu Link terminal is in connection, and the TV is controlled by signal that amplifier receives.

Description of Major LSIs

■ M171202JNV (IC461) : System Controller

1. Terminal Layout

V _{DD}	1	64	OSC
S13	2	63	OSC
S14	3	62	GND
S15	4	61	
S16	5	60	GND
S17	6	59	CK
S18	7	58	RST
S19	8	57	HOLD
S20	9	56	TV CONT
S21	10	55	STAND BY
S22	11	54	DI
S23	12	53	VCR IN
CS	13	52	TV OUT
A	14	51	LOAD
B	15	50	DATA
C	16	49	SCK
D	17	48	DCS OUT
V _{PP}	18	47	DCS IN
S1	19	46	INH
S2	20	45	RM IN
S3	21	44	KI-3
S4	22	43	RESET
S5	23	42	DATA
S6	24	41	STB1
S7	25	40	SCLK
S8	26	39	STB2
S9	27	38	SI
S10	28	37	SO
S11	29	36	SCK2
S12	30	35	STB4
KI-0	31	34	STB3
KI-1	32	33	KI-2

2. Key matrix

	KI-0 (IC461 31pin)	KI-1 (IC461 32pin)	KI-2 (IC461 33pin)	KI-3 (IC461 44pin)
Y0	POWER	CSRP TEST	CSRP ON/OFF	CSRP MEMORY
Y1	VOLUME +	VOLUME -	MUTE	
Y2	TAPE 2	TAPE 1		
Y3	CD	PHONO	VCR2	VCR1
Y4	CENTER +	CENTER -	DOLBY	SURROUND
Y5	DOLBY TEST	CENTER	STADIUM	HALL
Y6	REAR +	REAR -	SEA FREQ +	SEA FREQ -
Y7	DELAY	BAL R	BAL L	LOUDNESS
Y8	SEA LEVEL +	SEA LEVEL -	SEA REC	SEA PRESET
Y9	SEA REVERSE	SEA FLAT	SEA MEMO	SEA
Y10	CHARA ENTER	CHARA +	CHARA -	CHARA

3. Pin Functions

NO.	symbol	I/O	Functions	NO.	symbol	I/O	Functions
1	V _{DD}	-	Power supply (+5V)	33	KI-2	I	Key matrix input
2	S13	O	FL segment control output	34	STB3	O	Strobe output to IC433 .
3	S14	O	∕	35	STB4	O	Strobe output to IC251,252 .
4	S15	O	∕	36	SCK2	O	Serial clock output to IC434 .
5	S16	O	∕	37	SO	O	Serial data output to IC434 .
6	S17	O	∕	38	SI	I	Serial data input from IC434.
7	S18	O	∕	39	STB2	O	Strobe signal output to IC307 .
8	S19	O	∕	40	SCLK	O	Serial clock output to IC302,304,305,307 .
9	S20	O	∕	41	STB1	O	Strobe output to IC302,304,305 .
10	S21	O	∕	42	DATA	O	Serial data output to IC302,304,305,307 .
11	S22	O	∕	43	RESET	I	Reset signal input
12	S23	O	∕	44	KI-3	I	Key matrix input
13	CS	O	Chip select output to IC434 .	45	RM IN	I	Remote control signal input
14	A	O	Key matrix & FL drive output	46	INH	I	Inhibit signal input
15	B	O	∕	47	DCS IN	I	Compu-link signal input
16	C	O	∕	48	DCS OUT.	O	Compu-link signal output
17	D	O	∕	49	SCK	O	Serial clock output to IC465
18	V _{PP}	-	-38V	50	DATA	O	Serial data output to IC465
19	S1	O	FL segment control output	51	LOAD	O	Load output to IC465
20	S2	O	∕	52	TV OUT	O	AV Compu-link signal output for TV
21	S3	O	∕	53	VCR IN	I	AV Compu-link signal input for VCR
22	S4	O	∕	54	DI	I	Serial data input from IC504
23	S5	O	∕	55	STANDBY	O	STANDBY indicator output
24	S6	O	∕	56	TV CONT	O	Control the remote signal to TV
25	S7	O	∕	57	HOLD	O	Hold signal output to IC421,IC465 .
26	S8	O	∕	58	RST	O	Reset signal output to IC421 .
27	S9	O	∕	59	CK	O	Serial clock output to IC504 .
28	S10	O	∕	60	GND	--	Ground
29	S11	O	∕	61		--	
30	S12	O	∕	62	GND	--	Ground
31	KI-0	I	Key matrix input	63	OSC2	O	
32	KI-1	I	∕	64	OSC1	I	

■ LC6514B-4131 (IC421):Tuner Control & FL Driver

1. Terminal Layout

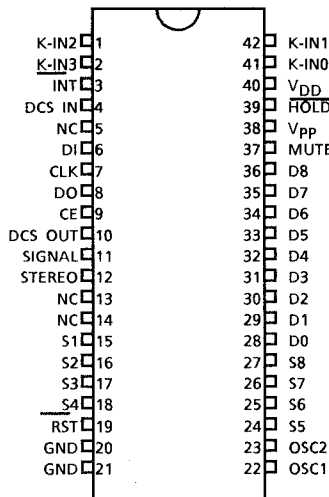

2. Key Matrix

Pin No.	IN OUT	41 (K-IN0)	42 (K-IN1)	1 (K-IN2)	2 (K-IN3)
28 (D0)	---	MEMORY	AUTO MEMORY	---	---
29 (D1)	FM	AM	---	FM MODE MUTE	---
30 (D2)	TUNE UP	TUNE DOWN	---	---	---
31 (D3)	1	2	3	4	---
32 (D4)	5	6	7	8	---
33 (D5)	9	10	+ 10	---	---

3. Pin Functions

Pin No.	Symbol	I/O	Functions
1	K-IN2	I	Key matrix input.
2	K-IN3	I	Key matrix input.
3	INT	I	Not used. (Connect to V _{DD} .)
4	DCS IN	I	COMPU-LINK signal input.
5	NC	—	Non connection.
6	DI	I	Serial data input from PLL (IC251 : LC7218).
7	CLK	O	Serial clock output to PLL (IC251 : LC7218).
8	DO	O	Serial data output to PLL (IC251 : LC7218).
9	CE	O	Chip enable output to PLL (IC251 : LC7218).
10	DCS OUT	O	COMPU-LINK signal output.
11	TUNED	I	Broadcast receiving when "L" is input.
12	STEREO	I	FM stereo reception when "L" is input.
13, 14	NC	—	Non connection.
15~18	S1~S4	O	Segment drive for FL display.
19	RST	I	Reset signal input.
20	GND	—	Connect to GND.
21	GND	—	Connect to GND.
22	OSC1	—	1MHz Resonator.
23	OSC2	—	1MHz Resonator.
24~27	S5~S8	O	Segment drive for FL display.
28~31	D0~D3	O	Digit drive for FL display and key matrix output.
32~33	D4~D5	O	Digit drive for FL display and key matrix output.
34	D6	O	Digit drive for FL display.
35	D7	O	Key matrix output.
36	D8	O	Key matrix output.
37	MUTE	O	Muting output.
38	V _P	—	-39V.
39	HOLD	I	Hold signal input.
40	V _{DD}	—	+5 V.
41	K-IN0	I	Key matrix input.
42	K-IN1	I	Key matrix input.

Internal Block Diagram of Other ICs

■ XR1091DCP (IC432) : Display Filter

1. Terminal Layout

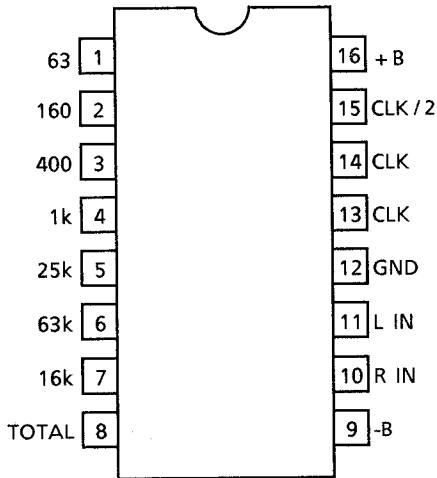

2. Pin Functions

Pin No.	Symbol	Functions
1	63	Peak hold output of 63Hz band-pass filter
2	160	Peak hold output of 160Hz band-pass filter
3	400	Peak hold output of 400Hz band-pass filter
4	1k	Peak hold output of 1kHz band-pass filter
5	25k	Peak hold output of 25kHz band-pass filter
6	63k	Peak hold output of 63kHz band-pass filter
7	16k	Peak hold output of 16Hz band-pass filter
8	TOTAL	Total frequency output (peak hold)
9	-B	Power supply (-6V)
10	R IN	Right channel input
11	L IN	Left channel input
12	GND	Ground
13	CLK	Connecting capacitor for clock
14	CLK	Connecting resistor to pin 13 for clock
15	CLK / 2	1/2 clock output
16	+B	Power supply (+6V)

■ TC74HC154P (IC462) : Decoder

1. Terminal Layout

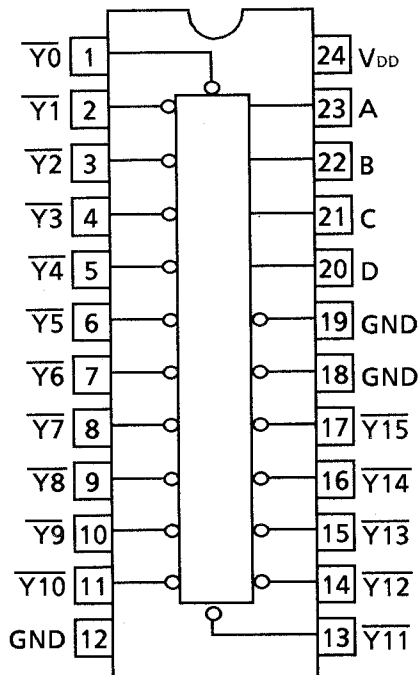

2. Function Table

Input						Output
G1	G2	D	C	B	A	
L	L	L	L	L	L	NC
L	L	L	L	L	H	NC
L	L	L	L	H	L	NC
L	L	L	L	H	H	NC
L	L	L	H	L	L	NC
L	L	L	H	L	H	11G
L	L	L	H	H	L	10G
L	L	L	H	H	H	9G
L	L	H	L	L	L	8G
L	L	H	L	L	H	7G
L	L	H	L	H	L	6G
L	L	H	L	H	H	5G
L	L	H	H	L	L	4G
L	L	H	H	L	H	3G
L	L	H	H	H	L	2G
L	L	H	H	H	H	1G
x	H	x	x	x	x	-
H	x	x	x	x	x	-

x : Don't Care

■ M50198P(IC651) : Digital Delay IC

1. Explanation of the operation

Audio signal is input to LPF1 to reduce the high frequency components. The output from LPF1 is coded to 1 bit signal by ADM modulator and comparator with inside .This digital signal is input to main control logic. And this signal obtain various effect,and is written in SRAM .At the same time main control logic read the data from SRAM ,and input it to ADM demodulator .The ADM demodulator converts 1bit signal to analog signal.The analog signal is input to LPF2 to reduce the suprius components,and output to Pin 13.

- LPF1 Reject the high frequency components which is contained the input signal and unnecessary.
- LPF2 Reject the suprius components which is generated by the ADM demodulation by using with comparator.
- OP1,CC1 For ADM modulator.
- OP2,CC2 For ADM demodulator.

2. Terminal Layout

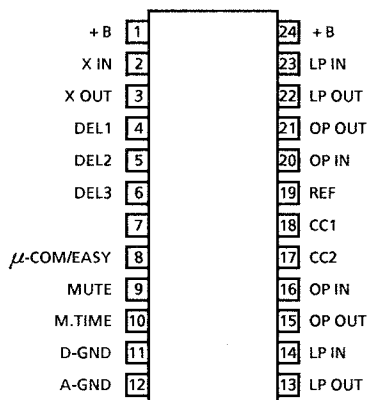

3. Pin functions

Pin No	Symbol	Functions	Pin No	Symbol	Functions
1	+ B	Power Supply	13	LP OUT	Output of LPF
2	X IN	Oscillation Terminal	14	LP IN	Input of LPF
3	X OUT	Oscillation Terminal	15	OP OUT	Integrator output
4	DEL1	Delay time control	16	OP IN	Integrator input
5	DEL2	"	17	CC2	Current control
6	DEL3	"	18	CC1	"
7	----	Connected to GND	19	REF	1/2 Vcc
8	μCOM/EASY	"	20	OP IN	Integrator input
9	MUTE	"	21	OP OUT	Integrator output
10	M.TIME	"	22	LP OUT	Output of LPF
11	D-GND	"	23	LP IN	Input of LPF
12	A-GND	"	24	+ B	Power supply

4. Block Diagram

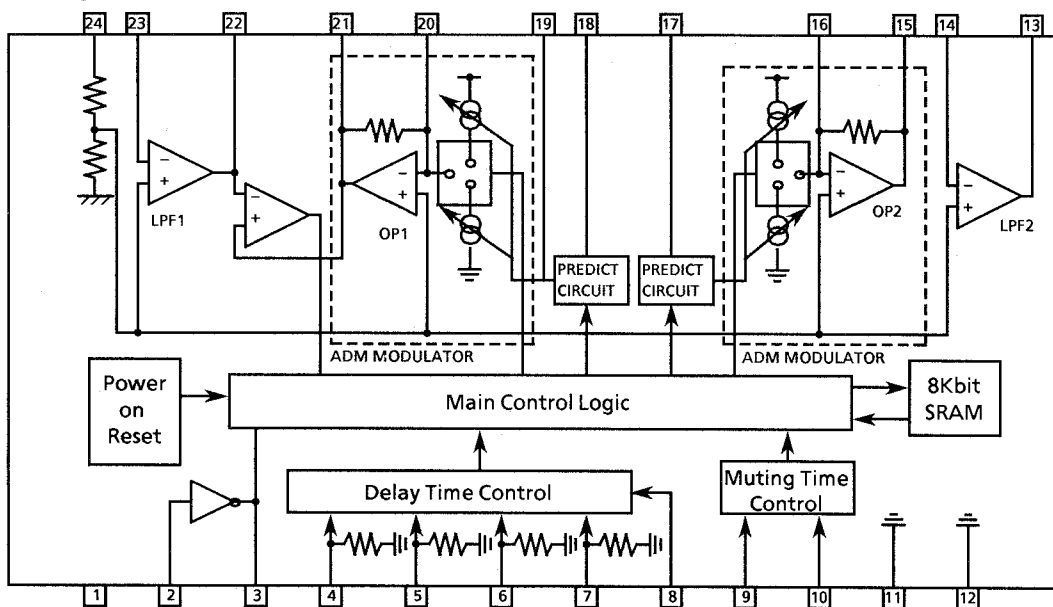

■ LC7522(IC504) : Variable Resistor for SEA Control

1. Terminal Layout 2. Block Diagram

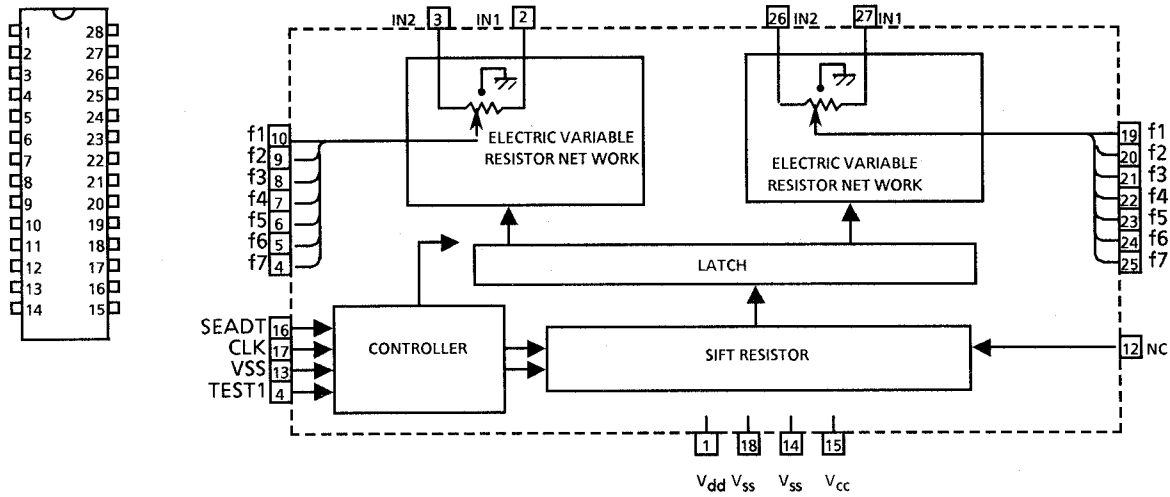

3. Pin Functions

Pin No.	Symbol	Functions
1	V_{DD}	Power supply (+7V)
18	GND	Ground.
13,14	V_{SS}	Power supply (-7V)
15	V_{CC}	Power supply (+5V)
2,27	IN 1	Audio signal input
3, 26	IN 2	The inversion signal of the operational amplifier inputs to IN 1 normally. The non-inversion signal of the operational amplifier inputs to IN 2 normally.
16	SEA DT	Data input from the CPU. Schmitt inverter type
17	SEA CK	Clock signal input from the CPU. Schmitt inverter type
4~10 19~25	f1~f7	For connect to band-pass filter. f1~f7x2 (Left and Right)
11	NC	Not used
12	NC	Not used
28	NC	Not used

■ AN6873N (IC463,464) : Inverter

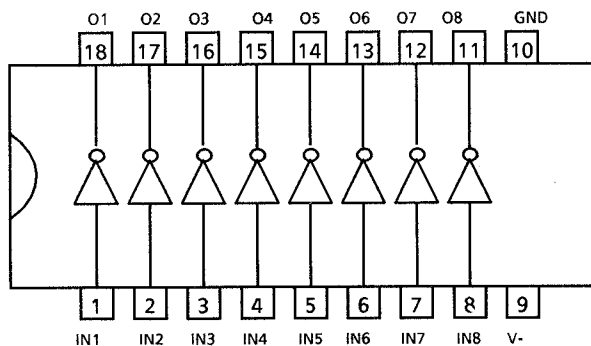

■ μ PC1188H (IC051,052) : Power Amplifier

1. Block Diagram

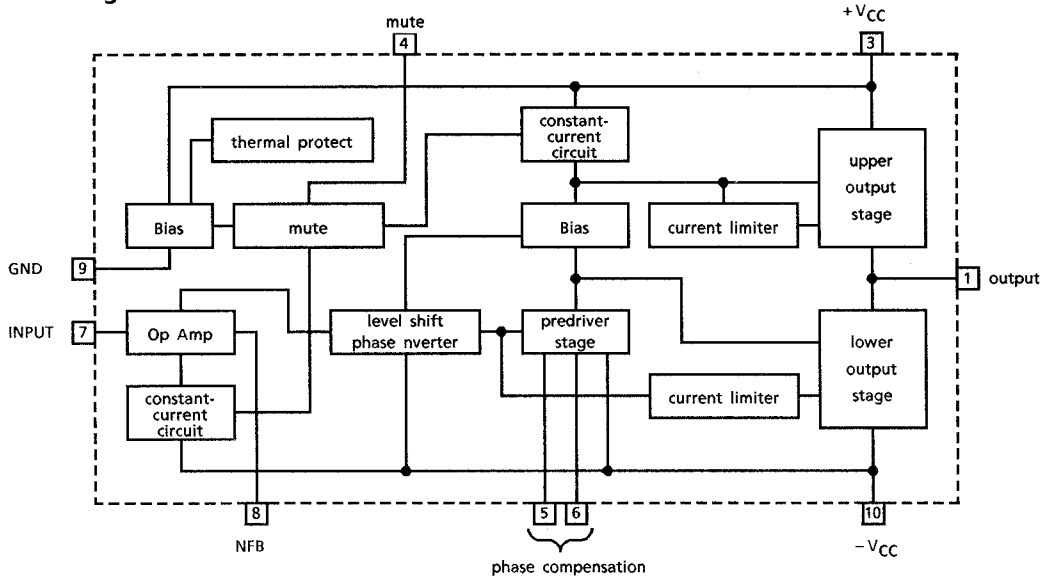

■ TA7317P (IC901,981) : Protector

1. Terminal Layout

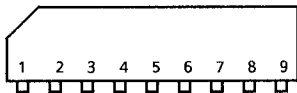

2. Block Diagram

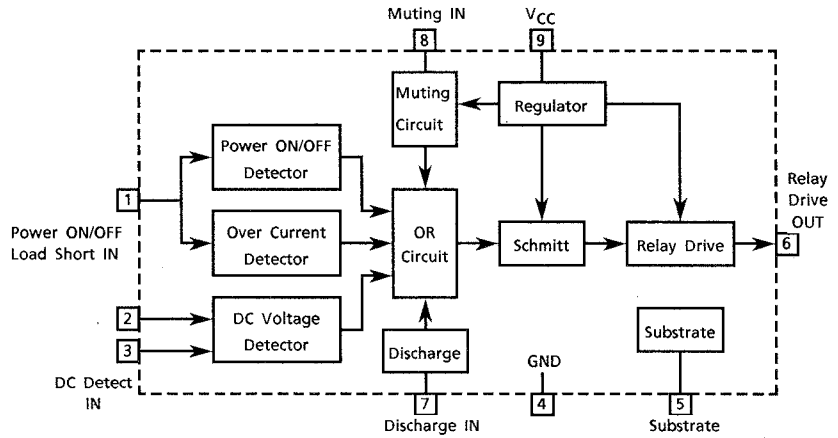

■ VC5022-2 (IC701,702) : Super- A

1. Terminal Layout

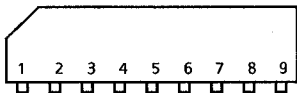

2. Block Diagram

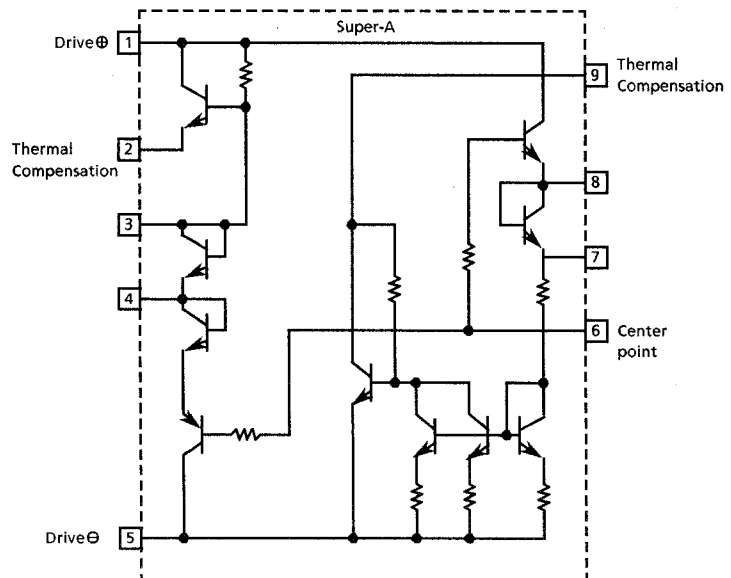

■ μ PD7001C(IC434)..... A/D Converter

1. Terminal Layout

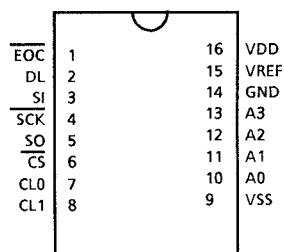

2. Block Diagram

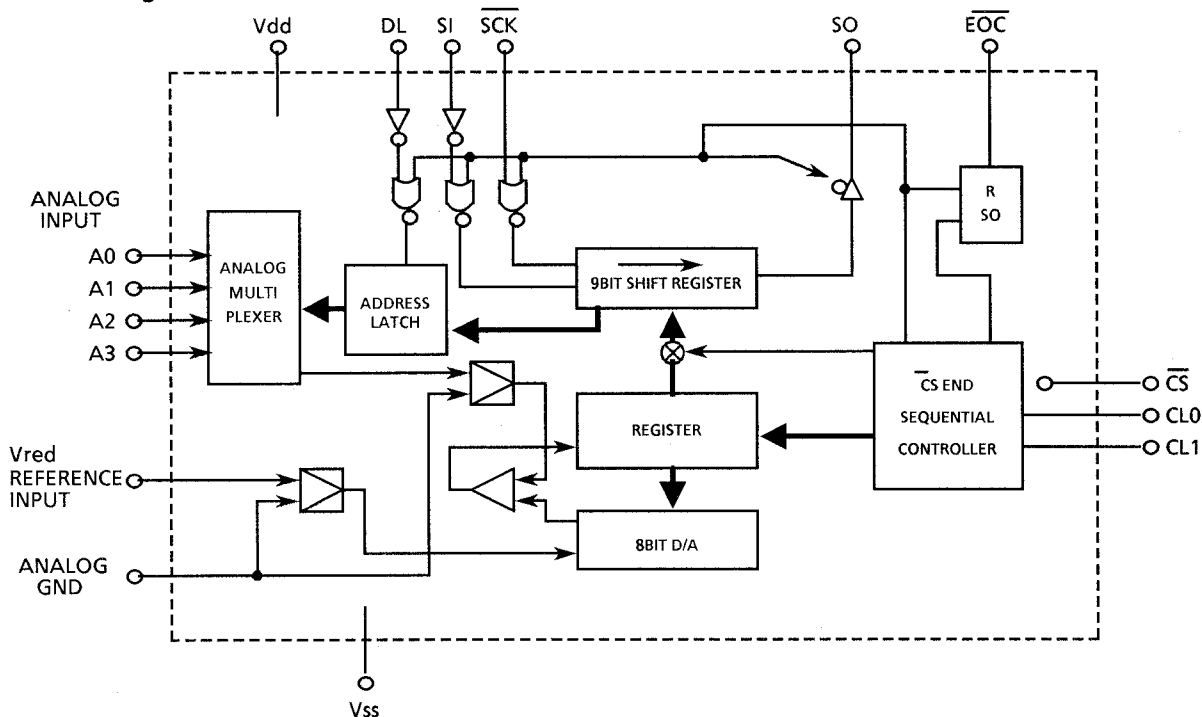

■ TC74HC595AP(IC251,252)..... 8 Bit Shift Register

1. Terminal Layout

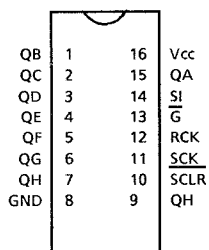

2. Function Table

Inputs					Functions
B1	SCK	SCLR	RCK	G	
X	X	X	X	H	Output (QA-QH) disable.
X	X	X	X	L	Output (QA-QH) enable.
X	X	L	X	X	Shift register is cleared.
L	\uparrow	H	X	X	Condition of shift register in initial stage is "L". In the other stages, data from the former stage is stored.
H	\uparrow	H	X	X	Condition of shift register in initial stage is "H". In the other stages, data from the former stage is stored.
X	\downarrow	H	X	X	Shift register does not change.
X	X	X	\uparrow	X	Shift register data is stored in the storage register.
X	X	X	\downarrow	X	Shift register does not change.

X: Don't care

■ MSC7112-01SS (IC465) : FL Driver

1. Terminal Layout

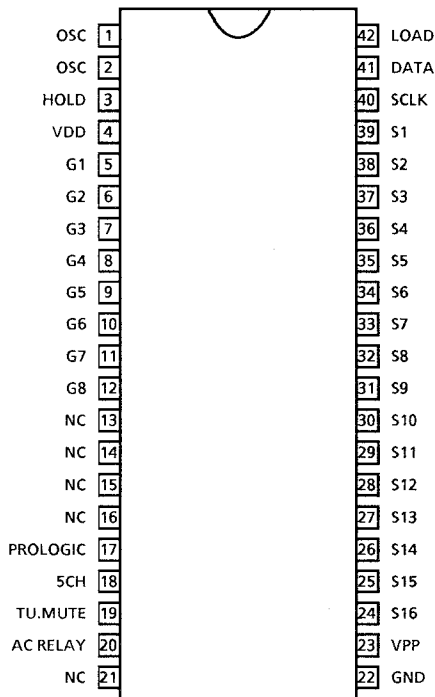

2. Pin Functions

Pin No.	Symbol	I/O	Functions
1	OSC	I	X'tal oscillation circuit input
2	OSC	O	X'tal oscillation circuit output
3	HOLD	I	Reset Input when power is just turned on.
4,23	VDD,VPP	I	VDD-Vpp Power supply for internal logic
5~12	G1~G8	O	Output for FL grid drive
13~16	NC	-	Non connection
17	PROLOGIC	O	Prologic indicator output
18	5CH	O	5CH indicator output
19	TU.MUTE	O	Tuner mute output
20	AC RELAY	O	AC Relay ON/OFF output
21	NC	-	Non connection
22	GND	-	Connected to Ground
24~39	S1~S16	O	Output for FL segment drive.
40	SCLK	I	Data shifts when sclk of shift-register is high-to-low level
41	DATA	I	Indication data input for shift-register
42	LOAD	I	Indication data for Latch clock

■ M51523AL (IC672) : Electro-volum IC

1. Terminal Layout

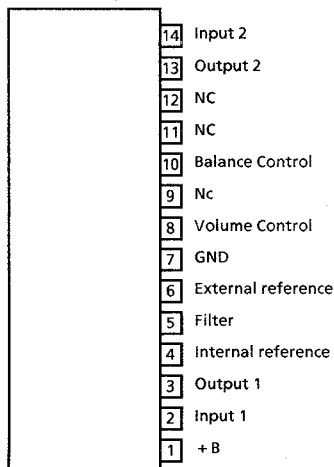

2. Block Diagram

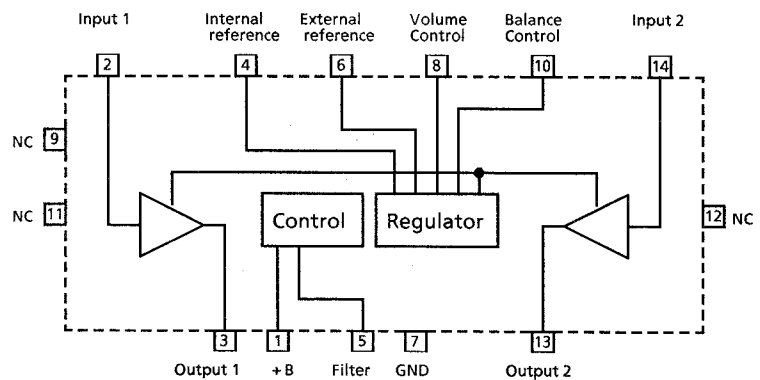

■ BA7625 (IC561) : Video Selector

1. Terminal Layout

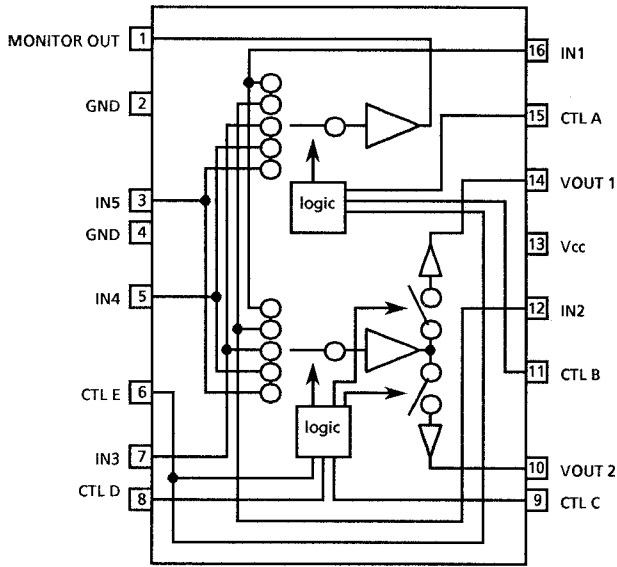

2. Function Table

A	B	E	MONITOR OUT
L	L	*	IN1
H	L	*	IN2
L	H	*	IN3
H	H	L	IN4
H	H	H	IN5

C	D	E	VOUT1
L	L	*	--
H	L	*	IN2
L	H	*	IN3
H	H	L	IN4
H	H	H	IN5

C	D	E	VOUT2
L	L	*	IN1
H	L	*	----
L	H	*	IN3
H	H	L	IN4
H	H	H	IN5

■ NJM2175L (IC611) : Dolby Pro Logic

1. Block Diagram

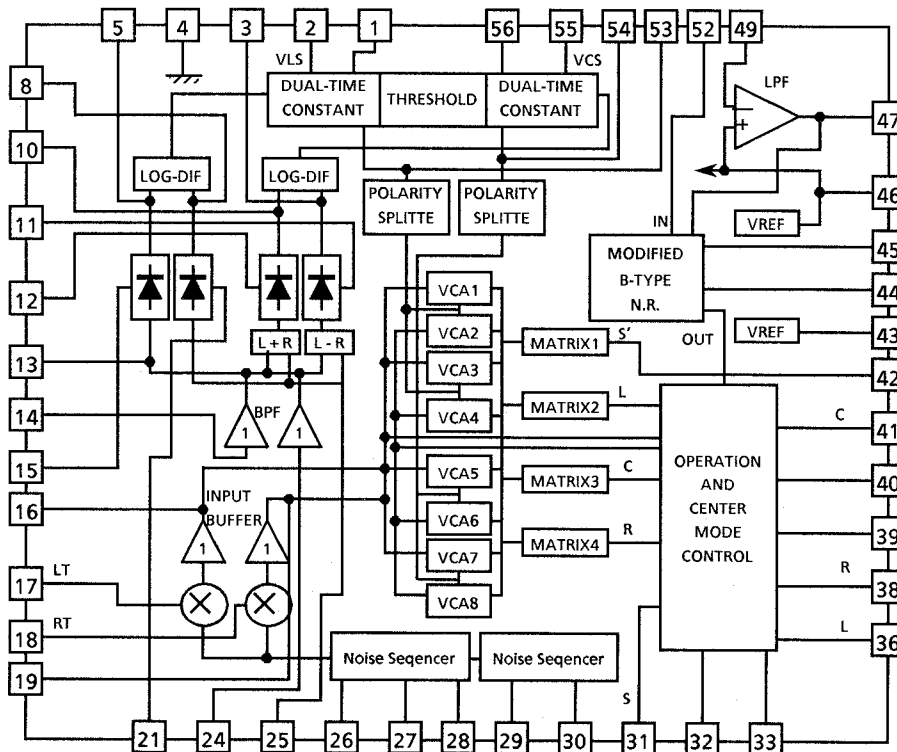

Internal Wiring of FL Display

Terminal Layout

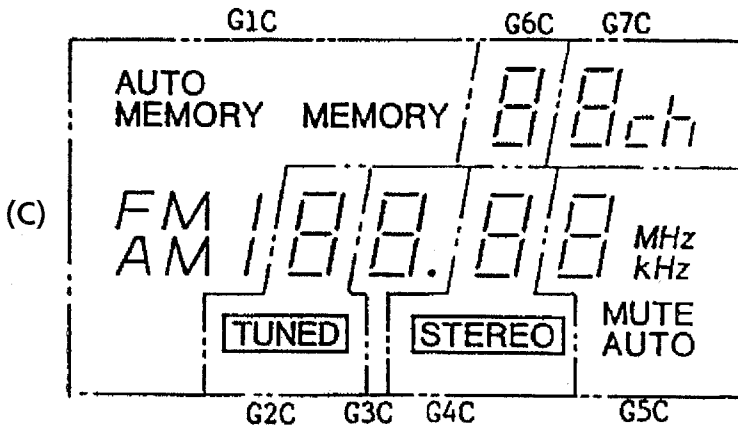
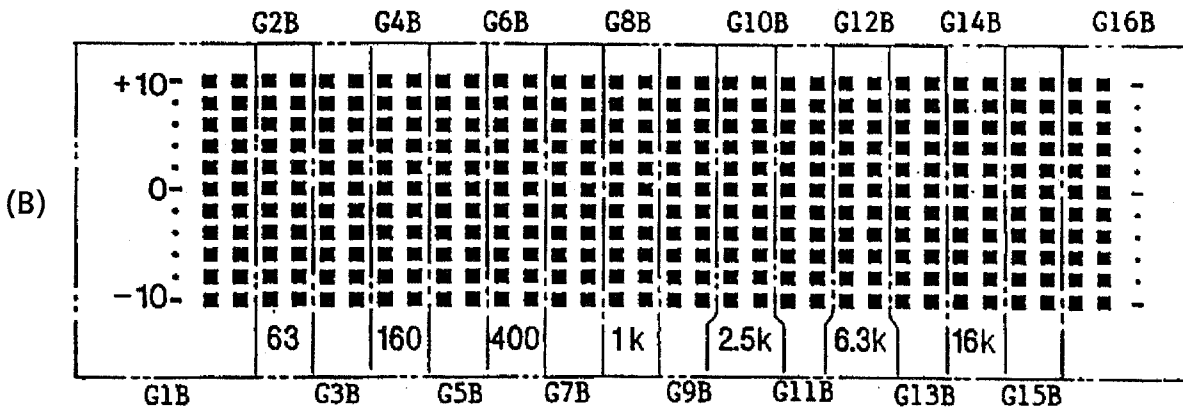
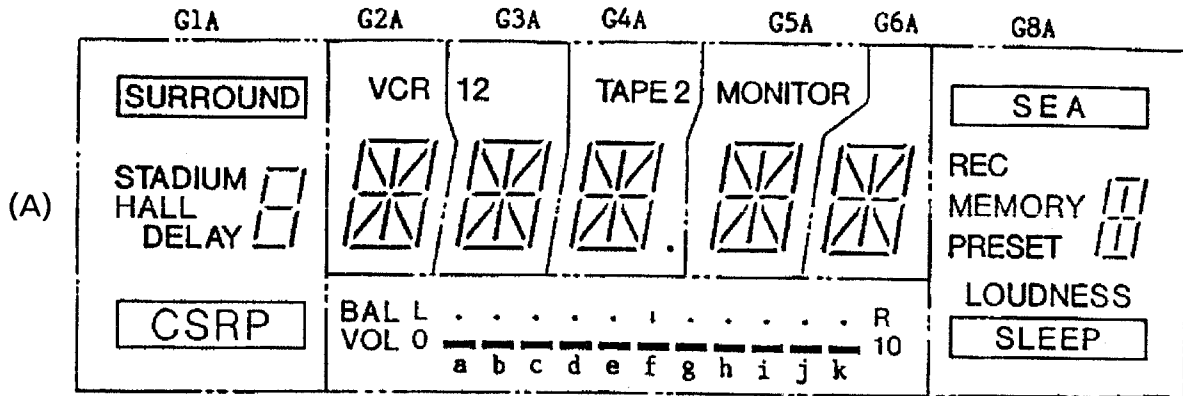

(G1B-G16B)

a	■	■	L
b	■	■	n
c	■	■	n
d	■	■	o
e	■	■	p
f	■	■	q
g	■	■	r
h	■	■	s
i	■	■	t
j	■	■	u
k	■	■	v

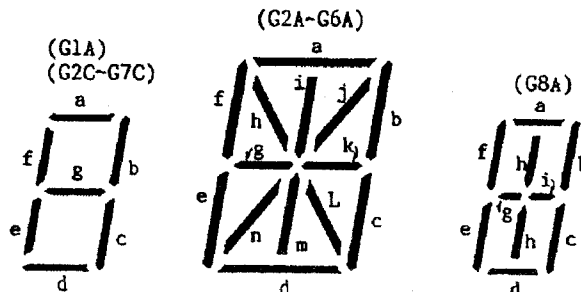

■ Pin Assignment

Pin No.	1	2	3	4	5	6	7	8	9	10	11	12	13	14	15	16	17	18	19	20	
Assignment	F	S1A	S2A	S6A	S10A	S9A	G7A	S8A	S7A	S11A	S3A	S5A	S4A	G1A	G2A	G3A	G4A	G5A	G6A	G8A	
Pin No.	21	22	23	24	25	26	27	28	29	30	31	32	33	34	35	36	37	38	39	40	
Assignment	S16A	S15A	S14A	S13A	S12A	PX	S12B	S11B	S10B	S9B	S8B	S7B	S6B	S5B	S4B	S3B	S2B	S1B	G1B	G2B	
Pin No.	41	42	43	44	45	46	47	48	49	50	51	52	53	54	55	56	57	58	59	60	
Assignment	G3B	G4B	G5B	G6B	G7B	G8B	G9B	G10B	G11B	G12B	G13B	G14B	G15B	G16B	S13B	S14B	S15B	S16B	S17B	S18B	
Pin No.	61	62	63	64	65	66	67	68	69	70	71	72	73	74	75	76	77	78	79	80	81
Assignment	S19B	S20B	S21B	S22B	23B	S1C	S5C	S6C	S4C	S8C	S7C	S3C	S2C	G1C	G6C	G7C	G5C	G4C	G3C	G2C	F

Notes ; F (Filament) , G (Grid) , S (Anode)

■ Grid-Anode Assignment

Grid-Anode Assignment (A)

	G1A	G2A	G3A	G4A	G5A	G6A	G7A	G8A
S1A	a	a	a	a	a	a	a	a
S2A	b	b	b	b	b	b	b	b
S3A	c	c	c	c	c	c	c	c
S4A	d	d	d	d	d	d	d	d
S5A	e	e	e	e	e	e	e	e
S6A	f	f	f	f	f	f	f	f
S7A	g	g	g	g	g	g	g	g
S9A	SURROUND	h	h	h	h	h	h	h
S9A	STADIUM	i	i	i	i	i	i	i
S10A	HALL	j	j	j	j	j	j	SEA
S11A	DELAY	k	k	k	k	k	k	REC
S12A	CSRP	l	l	l	l	l●.....	MEMORY
S13A		m	m	m	m	m	VOL 0 10	PRESET
S14A		n	n	n	n	n	BAL L R	LOUDNESS
S15A		VCR	1		MONITOR			SLEEP
S16A			2	TAPE2				

Grid-Anode Assignment (B)

	G1C	G2C	G3C	G4C	G5C	G6C	G7C
S1C		TUNED	●	STEREO	MUTE AUTO		ch
S2C	AUTO MEMORY	a	a	a		a	a
S3C		b	b	b	MHz	c	c
S4C	MEMORY	c	c	c	KHz	c	c
S5C		d	d	d	g	d	d
S6C	FM	e	e	e	c, f	e	e
S7C	AM	f	f	f	b, e	f	f
S8C	b, c	g	g	g	a, d	g	g

Grid-Anode Assignment (C)

	G1B	G2B	G3B	G4B	G5B	G6B	G7B	G8B	G9B	G10B	G11B	G12B	G13B	G14B	G15B	G16B
S1B	a	a	a	a	a	a	a	a	a	a	a	a	a	a	a	a
S2B	b	b	b	b	b	b	b	b	b	b	b	b	b	b	b	b
S3B	c	c	c	c	c	c	c	c	c	c	c	c	c	c	c	c
S4B	d	d	d	d	d	d	d	d	d	d	d	d	d	d	d	d
S5B	e	e	e	e	e	e	e	e	e	e	e	e	e	e	e	e
S6B	f	f	f	f	f	f	f	f	f	f	f	f	f	f	f	f
S7B	g	g	g	g	g	g	g	g	g	g	g	g	g	g	g	g
S9B	h	h	h	h	h	h	h	h	h	h	h	h	h	h	h	h
S9B	i	i	i	i	i	i	i	i	i	i	i	i	i	i	i	i
S10B	j	j	j	j	j	j	j	j	j	j	j	j	j	j	j	j
S11B	k	k	k	k	k	k	k	k	k	k	k	k	k	k	k	k
S13B	l	l	l	l	l	l	l	l	l	l	l	l	l	l	l	l
S14B	m	m	m	m	m	m	m	m	m	m	m	m	m	m	m	m
S15B	n	n	n	n	n	n	n	n	n	n	n	n	n	n	n	n
S16B	o	o	o	o	o	o	o	o	o	o	o	o	o	o	o	o
S17B	p	p	p	p	p	p	p	p	p	p	p	p	p	p	p	p
S18B	q	q	q	q	q	q	q	q	q	q	q	q	q	q	q	q
S19B	r	r	r	r	r	r	r	r	r	r	r	r	r	r	r	r
S20B	s	s	s	s	s	s	s	s	s	s	s	s	s	s	s	s
S21B	t	t	t	t	t	t	t	t	t	t	t	t	t	t	t	t
S22B	u	u	u	u	u	u	u	u	u	u	u	u	u	u	u	u
S23B	v	v	v	v	v	v	v	v	v	v	v	v	v	v	v	v
S12B	+10- ● ● ● 0- ● ● ● -10-	63	160	400	1k	2.5k	6.3k	16k								- ● ● ● ● ● ● -

Disassembly Procedures

■ Removing the top cover

1. Remove 4 screws on both sides.
2. Remove 2 screws located on the top of rear panel.
3. Slightly open both sides of the top cover, to the left and right, and raise the rear side. Then slowly lift it up and straight backward.

■ Removing the front panel (Fig 1, Fig 3)

1. Remove the top cover.
2. Remove 3 plastic rivets (A) on the upper part of the front panel, and 4 screws from the lower part. (B),.
3. Remove the front panel.

■ Removing the FL Display PCB (Fig 4)

1. Remove 2 screws (C).
2. Remove the all connectors.

■ Removing the bottom plate (Fig 3)

1. Remove 14 screws (D).

■ Removing the power transistors

1. Remove the top cover and the bottom plate.
2. Unsolder the defective power transistor.
3. Remove the screw holding the power transistor using a pair of pliers, a wrench or a bent screwdriver.

■ Removing the main P.C.B.

● ENC-802-2

1. Remove 1 plastic rivets.
2. Pull off the connectors (PA651, PA671).

● ENF-061

Refer to page 1-49 Service Precaution .

● ENA-095 (Fig 1, Fig 3)

1. Remove 2 screws (E) on the rear panel and also remove 4 screws (F) fixing the circuit board and the chassis.
2. Pull off the connectors (P101, P103) front the sockets.

● ENC-802-3 (Fig 2)

1. Remove 2 screws (G) on the rear panel, then pull off the connector .

● ENC-802-4 (Fig 2)

1. Remove 2 screw (H) on the rear panel.

● ENC-802-6 (Fig 2)

1. Remove 1 screw (I) on the rear panel.

● ENC-802-1 (Fig 2)

1. Remove the ENA-095.
2. Remove the plastic rivets fixing the front panel and circuit board (ENB-130), (ENC-082-2).
3. Remove the circuit board (ENC-082-3, ENC-082-4, ENC-082-6).
4. Remove 4 screws (J) on the rear panel and also remove 5 screws fixing the circuit board and the chassis.
5. Pull off the all connectors on the circuit board (ENC-082).

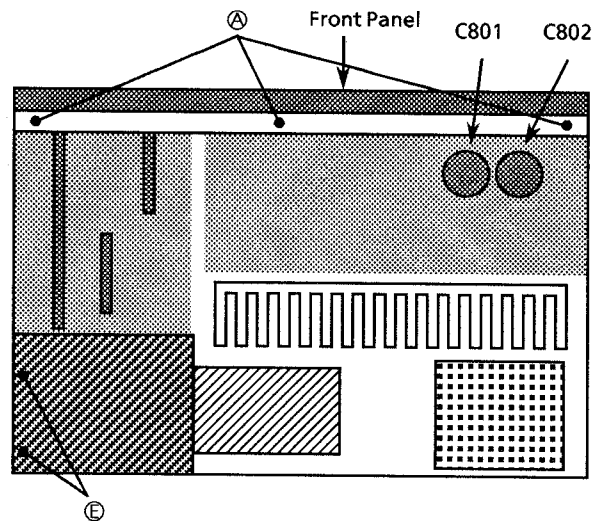

Fig 1. Top View

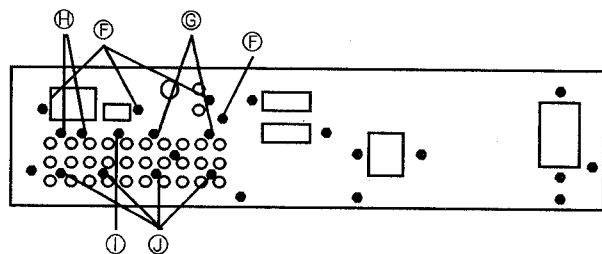

Fig 2. Rear View

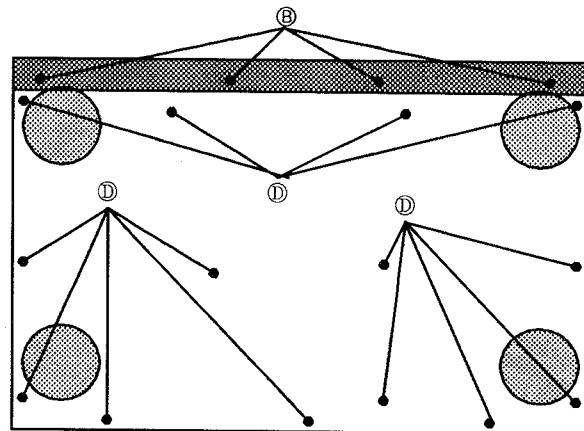

Fig 3. Bottom Cover

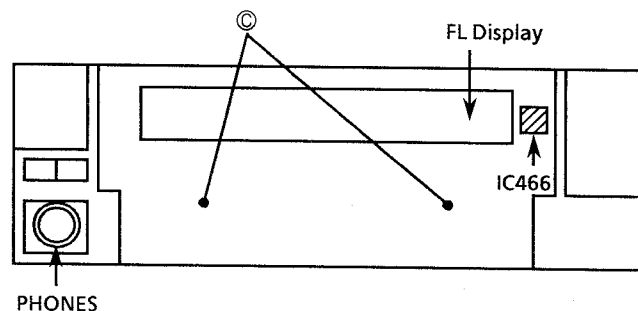
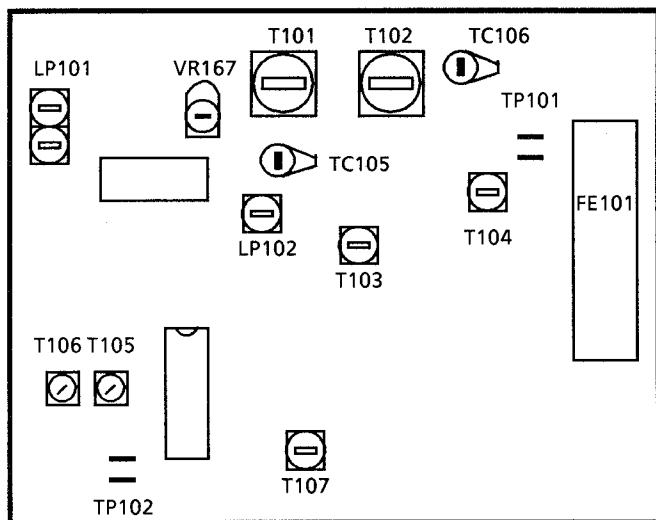

Fig 4. Front P.C. Board(ENC-071-10)

FM/AM Tuner Alignment Procedures



FRONT

1. FM section

■ FM oscillator : L103

- (1) Set the frequency display to "108.0MHz".
- (2) Confirm the FM inter-station noise is received.
- (3) Adjust L103 so that the voltage of test point "TP251" becomes $8.3V \pm 0.1V$.
- (4) Set the frequency display to "87.5MHz" and confirm the voltage of test point "TP251" is $1.5V \sim 2.2V$.

■ FM antenna coil : L101, L102,

- (1) Adjust L101, and L102 to obtain the maximum sensitivity at 89.9 MHz.

■ FM antenna trimmer : TC101, TC102

- (1) Adjust TC101 and TC102 to obtain the maximum sensitivity at 105.9MHz.
- (2) Repeat the adjustment of L101, L102, TC101 and TC102.

■ FM detector coil : T141, T142

- (1) Connect a digital voltmeter to test point "TP141", and receive to "100.1MHz" signal with SSG ATT 70 dB.
- (2) Adjust T141 so that the digital voltmeter becomes $0 \pm 1.5mV$.
- (3) At the same time, Adjust T142 so that the monaural distortion of the output becomes minimised.

2. MW section

Note: [] : The U.S.A., Canada
() : Australia, the U.K. and Continental Europe
{ } : Other countries
Channel space 9kHz
[] : Other countries
Channel space 10kHz

■ MW oscillator : T103

- (1) Set the frequency display to [530kHz] (522kHz) {531kHz} [530kHz] and confirm the voltage of test point TP101 is $0.9V \pm 0.2V$.
- (2) Set the frequency display to [1710kHz] (1629kHz) {1602kHz} [1600kHz] and confirm the voltage of test point TP101 is [$8.0 \pm 0.8V$] ($7.5V \pm 0.8V$) { $7.2V \pm 0.7V$ } [$7.2 \pm 0.7V$].
- (3) If its voltage exceeds the allowance, adjust T103 to obtain the voltage.

■ MW antenna coil : T101

- (1) Connect a loop antenna to the "AM Loop" terminal on the rear panel.
- (2) Adjust T101 to obtain the best receiving sensitivity at 600kHz or 603kHz.

■ MW antenna trimmer : TC105

- (1) Adjust TC105 to obtain the best receiving sensitivity on 1400kHz or 1404kHz.

3. LW section (for RX-805VLTN)

Note [] : Italy

■ LW oscillation : T104

- (1) Set the frequency display to 144kHz and adjust T104 so that the voltage of TP101 becomes $0.8 \pm 0.4V$ [$0.8V \pm 0.1V$].
- (2) Set the frequency display to 353kHz [290kHz] and confirm the voltage of test point TP101 is $7.7V \pm 0.6V$ [$5.7V \pm 0.5$].

■ LW antenna coil : T102

- (1) Connect a loop antenna to the "AM Loop" terminal on the rear panel.
- (2) Adjust T102 to obtain the best receiving sensitivity at 164kHz [164kHz].

■ LW antenna trimmer : TC106

- (1) Adjust TC106 to obtain the best receiving sensitivity at 353kHz [245kHz].

Power Amplifier Adjustment Procedures

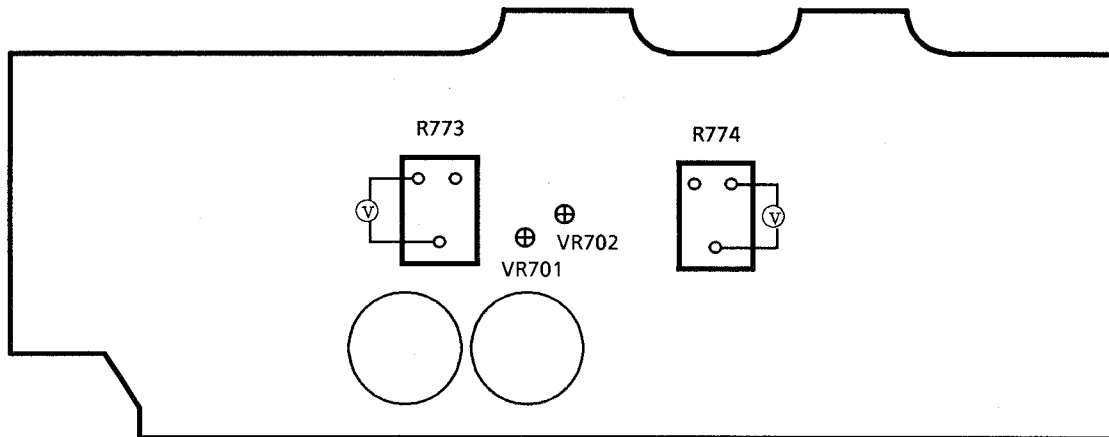

■ Idling Current

- (1) Turn VR701 and VR702 fully counterclockwise before the power switch on.
- (2) Warm up at least 5 minutes before adjustment.
- (3) Must keep the heatsink to prevent overheating before adjustment.
- (4) Set the volume control to minimum during this adjustment.
- (5) Connect a DC voltmeter to R773 resistor's leads for left channel, or to R774 for right channel.
- (6) Adjust VR701 for left channel, or VR702 for right channel, so that the DC voltmeter becomes 2mV ~ 7mV

■ Confirm the waveforms for surround effects

Dolby

- (1) Provide a sine wave signal 40 Hz, 500 mVp-p to the left channel of CD input terminal.
- (2) Connect X-axis of oscilloscope to the input signal and Y-axis to the left channel terminal of rear speaker terminals.
- (3) Set the DELAY TIME to 1, 2, and 3.
- (4) Adjust the REAR LEVEL & VOLUME controls to 500 mV at the left channel of rear speaker terminals.
- (5) Confirm the below waveforms. (Fig - 1, Fig - 2, Fig - 3)

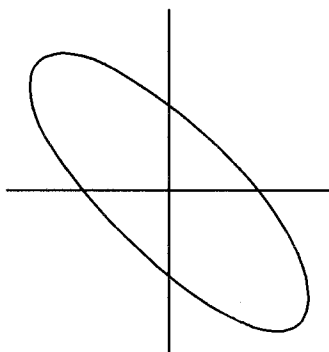

Fig-1 (Delay 1)

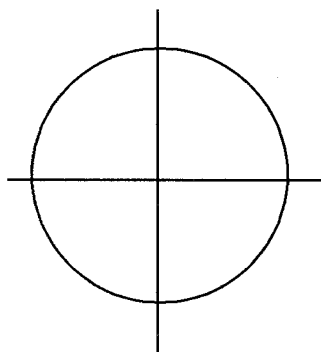

Fig-3 (Delay 2)

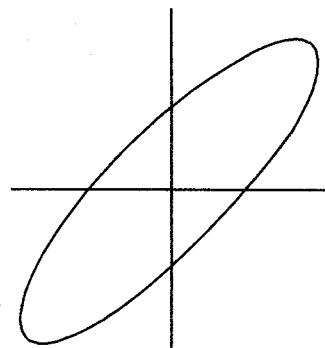

Fig-3 (Delay 3)

HALL : DELAY TIME - 2

- (1) Provide a sine wave signal 40 Hz, 500 mVp-p to the left channel of CD input terminal.
- (2) Connect X-axis of oscilloscope to the input signal and Y-axis to the left channel terminal of rear speaker terminals.
- (3) Set the DELAY TIME to 2.
- (4) Adjust the REAR LEVEL & VOLUME controls to 500 mV at the left channel of rear speaker terminals.
- (5) Confirm the below waveform. (Fig - 4)

STADIUM : DELAY TIME - 2

- (1) Provide a sine wave signal 40 Hz, 500 mVp-p to the right channel of CD input terminal.
- (2) Connect X-axis of oscilloscope to the input signal and Y-axis to the right channel terminal of rear speaker terminals.
- (3) Set the DELAY TIME to 2.
- (4) Adjust the REAR LEVEL & VOLUME controls to 500 mV at the right channel of rear speaker terminals.
- (5) Confirm the below waveform. (Fig - 5)

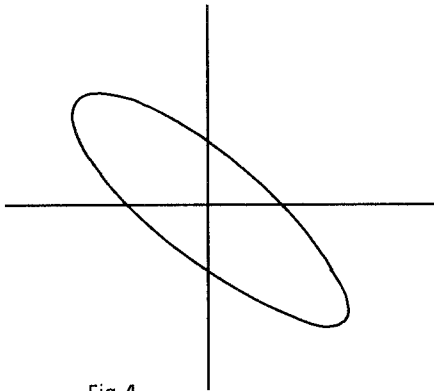

Fig-4

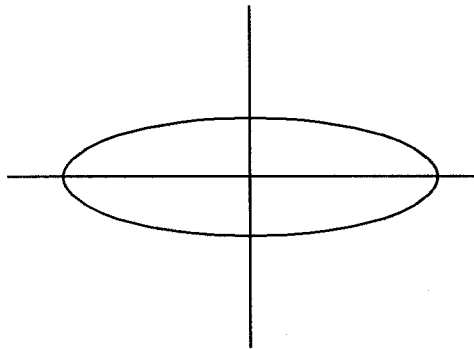
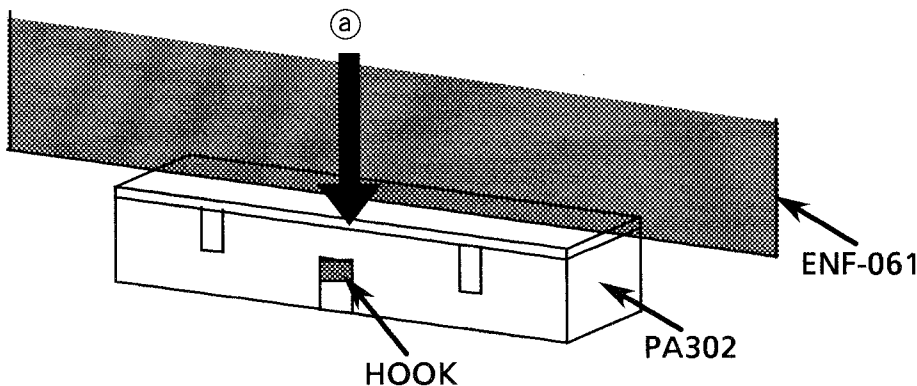

Fig-5

Service Precaution**■ Removing the P.C.B (ENF-061)**

1. Pull off the connector (PA302).

- Notes :**
- Insert a flat screwdriver to ① for release when disconnecting.
 - Be careful when inserting a screwdriver to a socket as shown in figure.



Block Diagram

■ Signal Flow

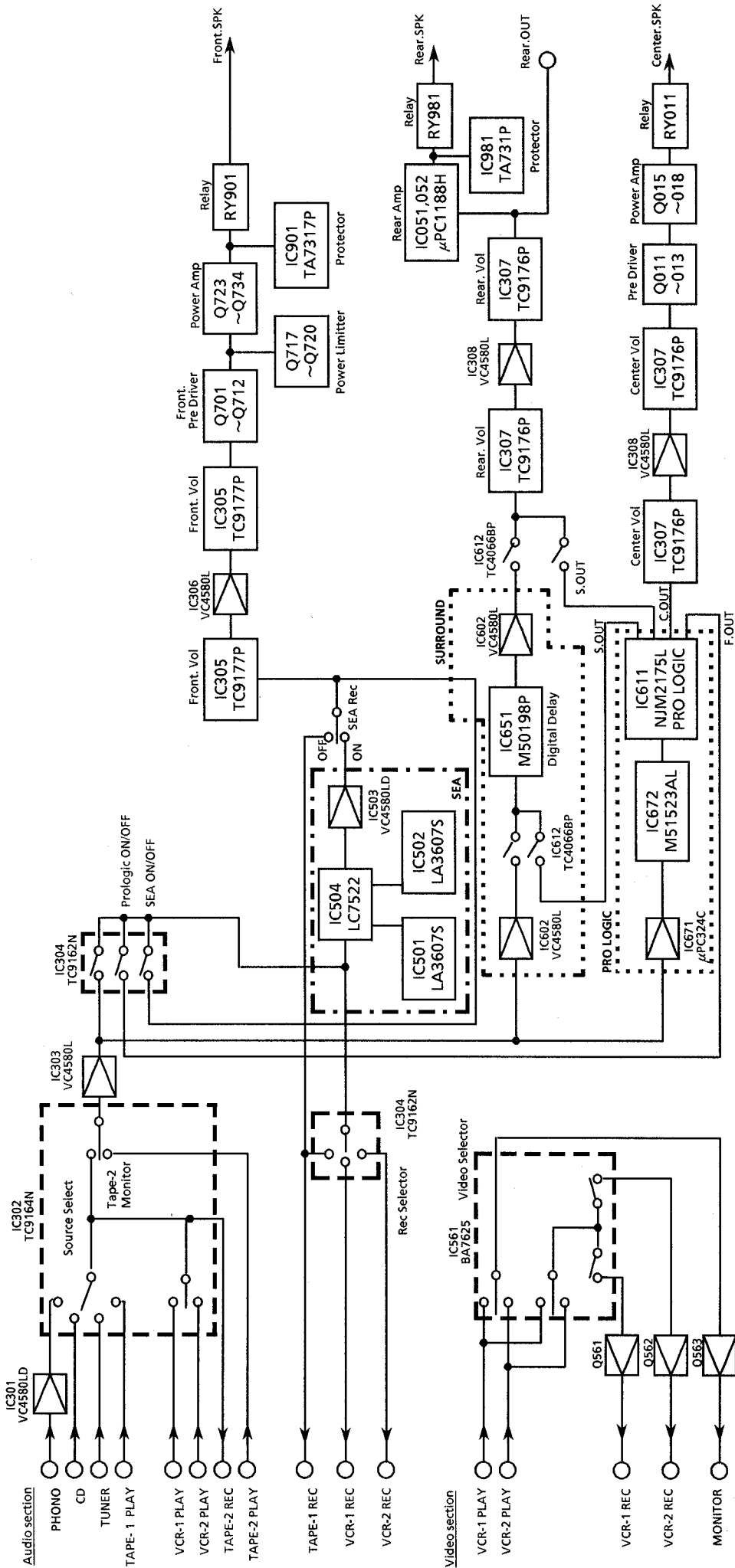

■ Tuner Section

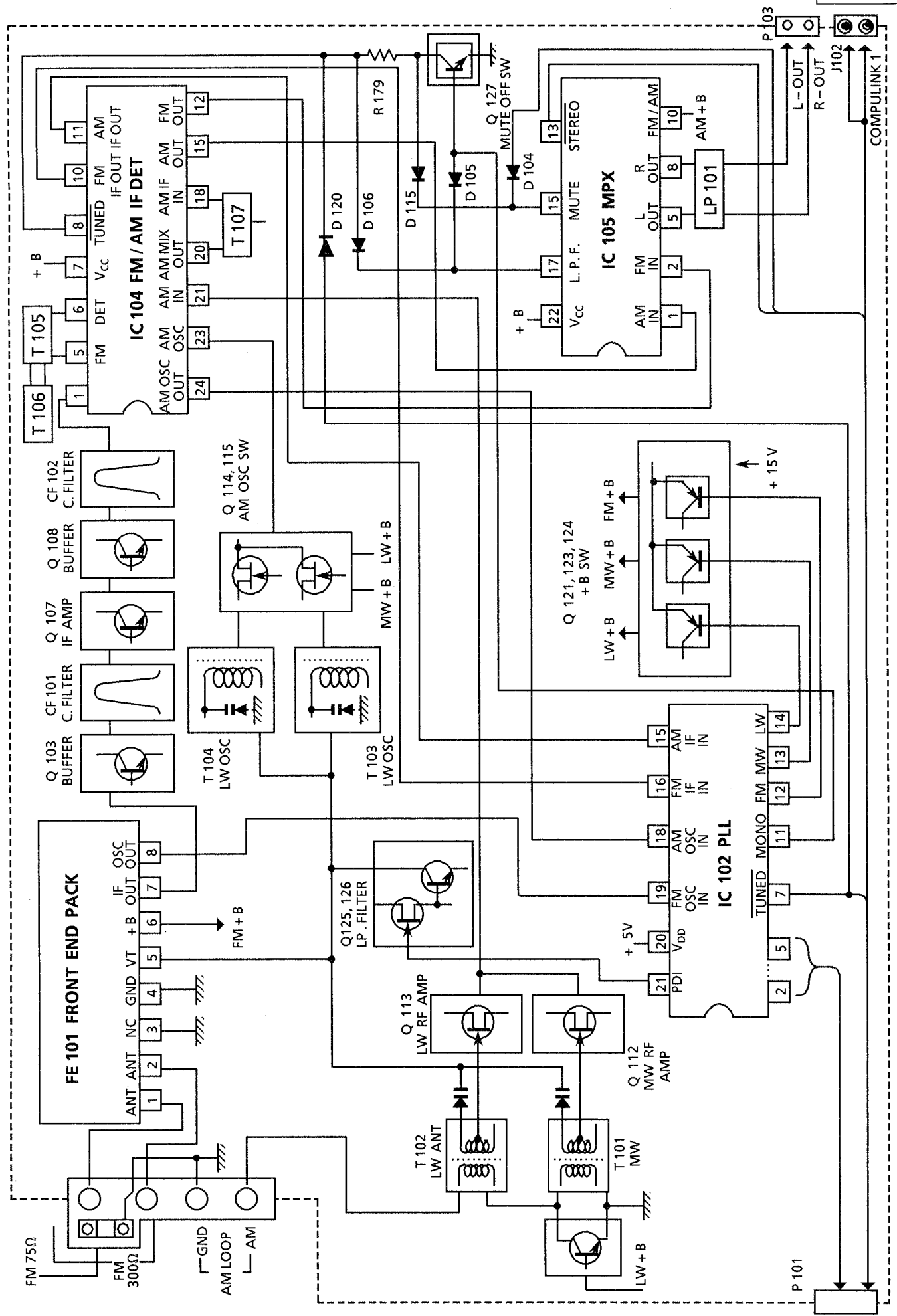

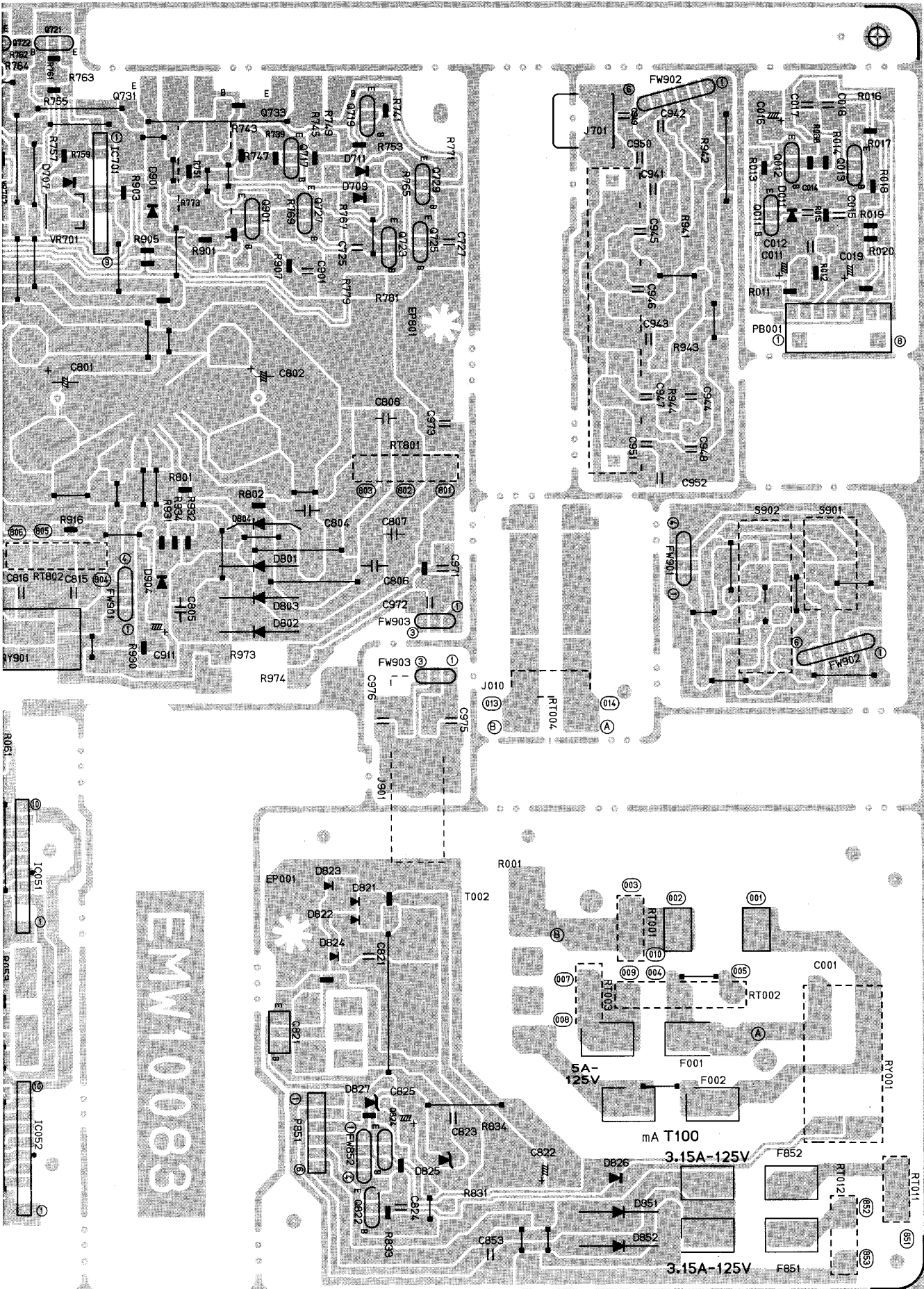

Control P.C. Board (ENB-123)

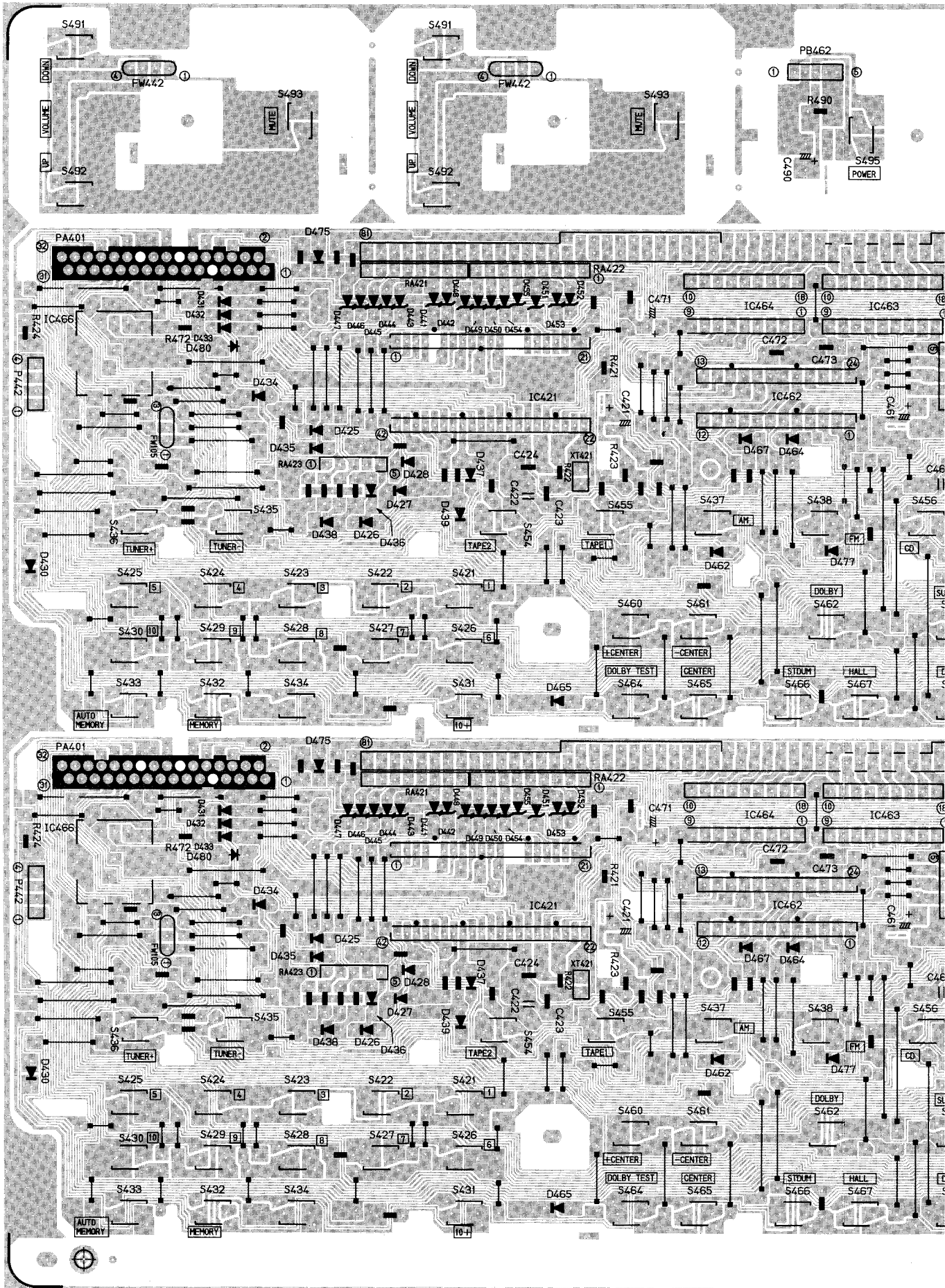

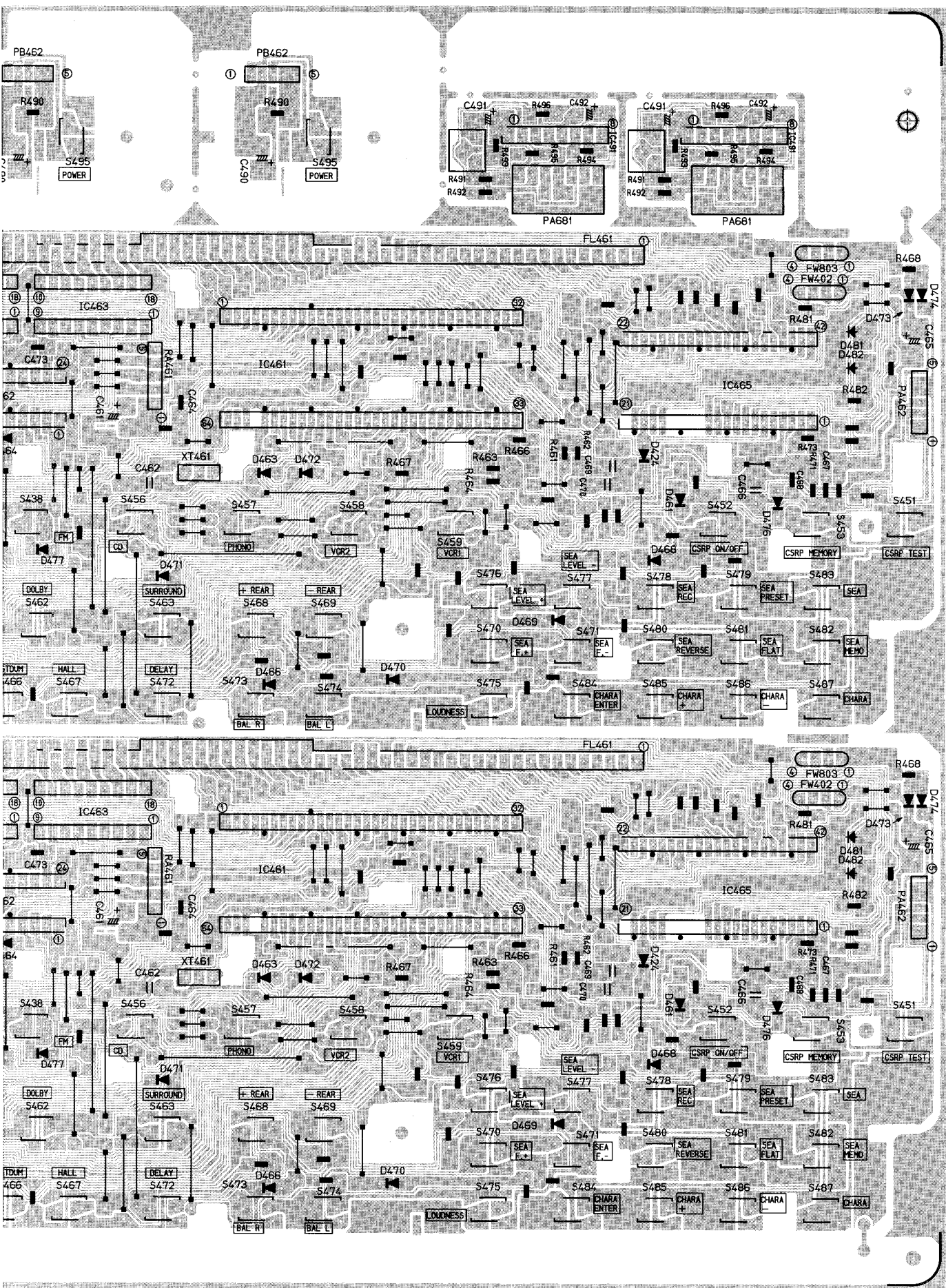

■ Tuner P.C. Board (ENA-095)

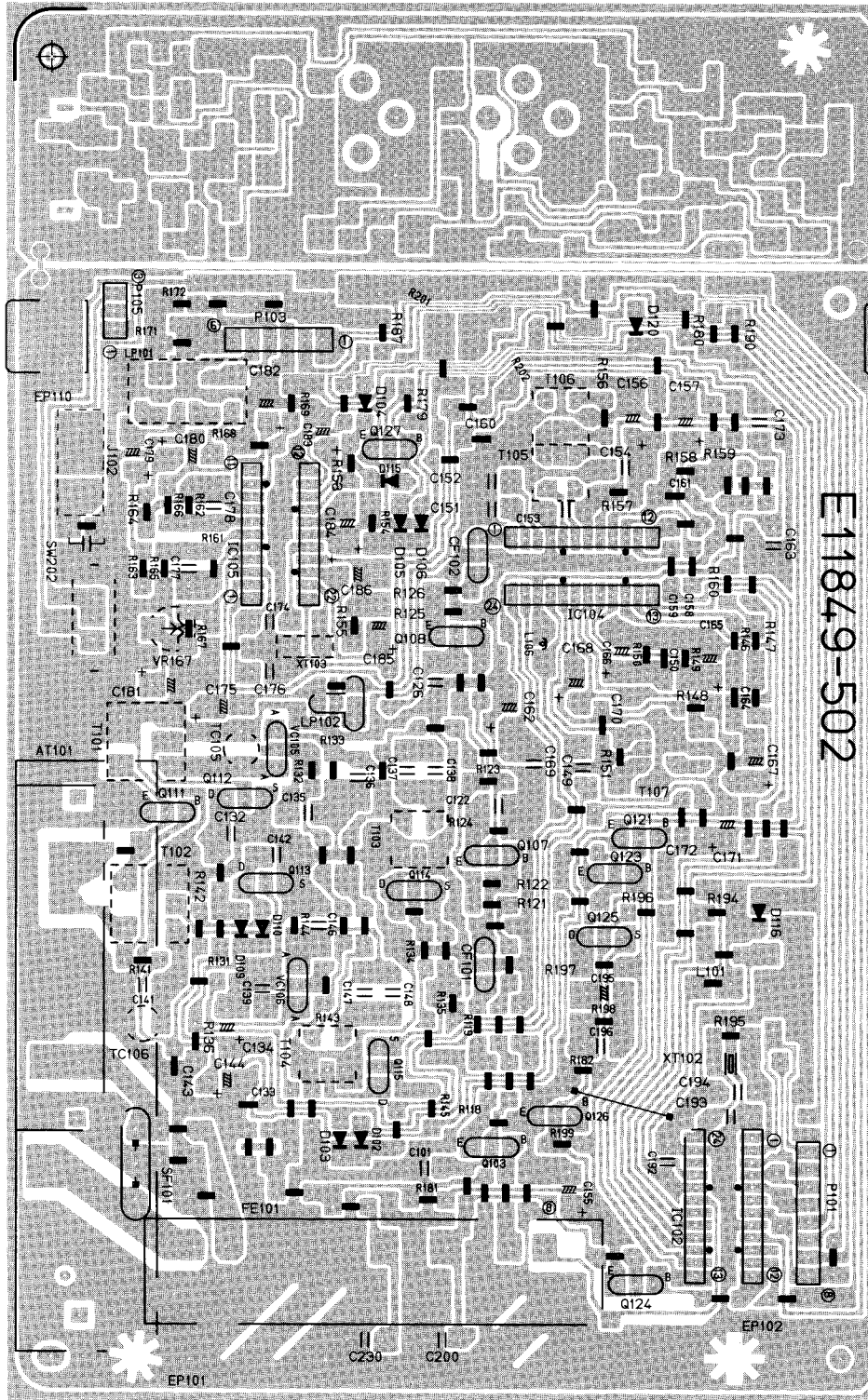

■ SEA P.C. Board (ENF-061)

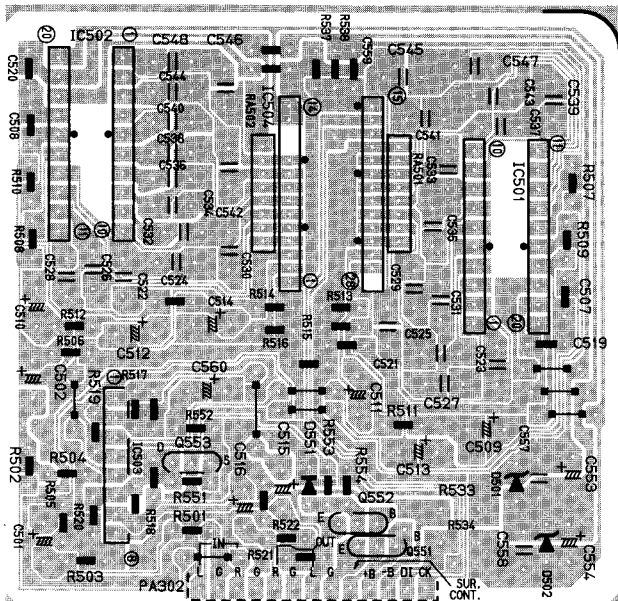

■ SPI P.C. Board (ENB-130)

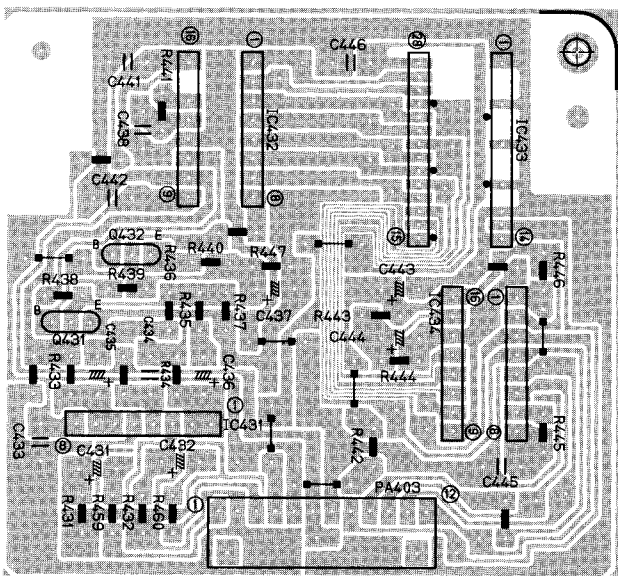

Connection Diagram

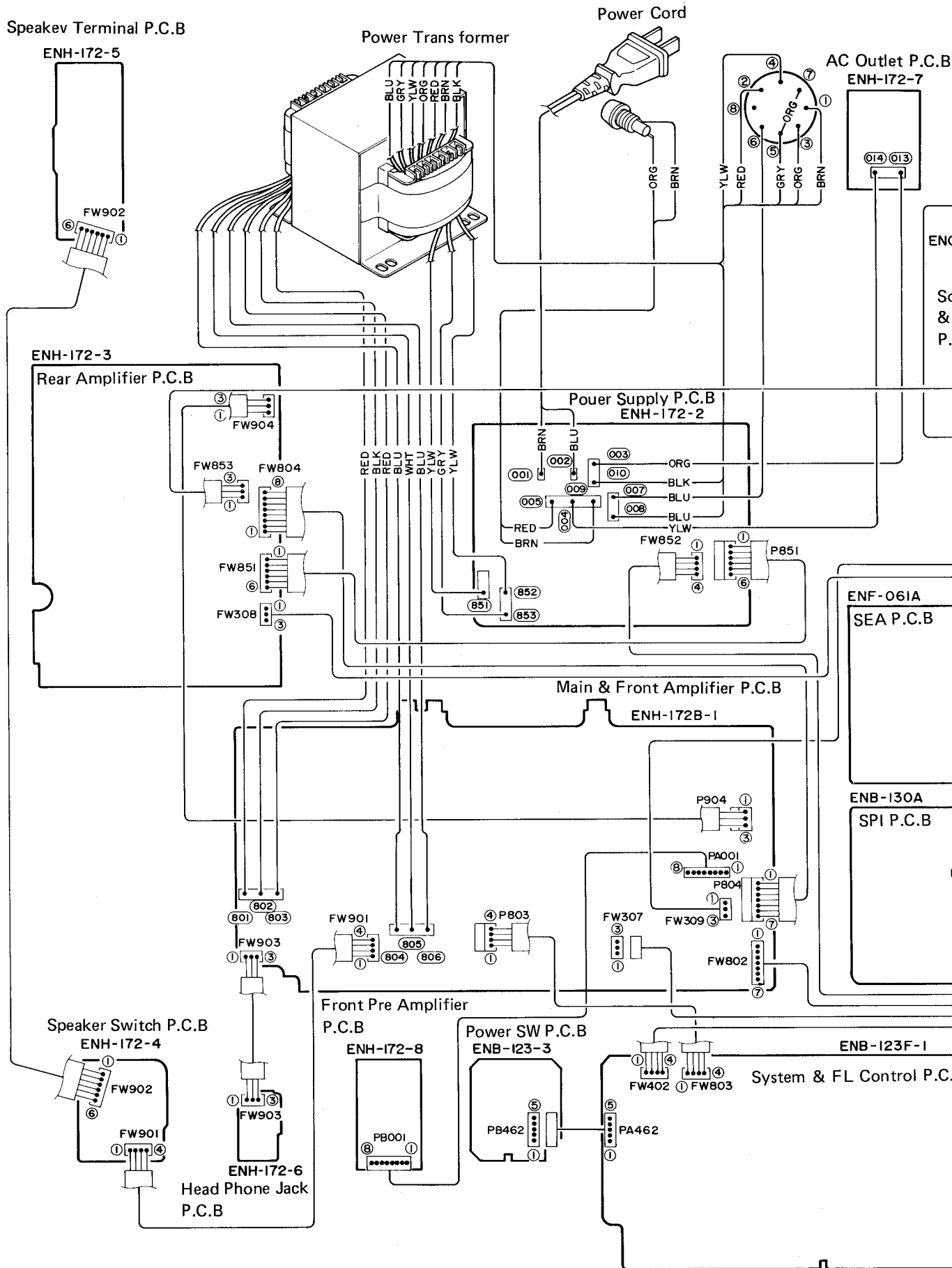

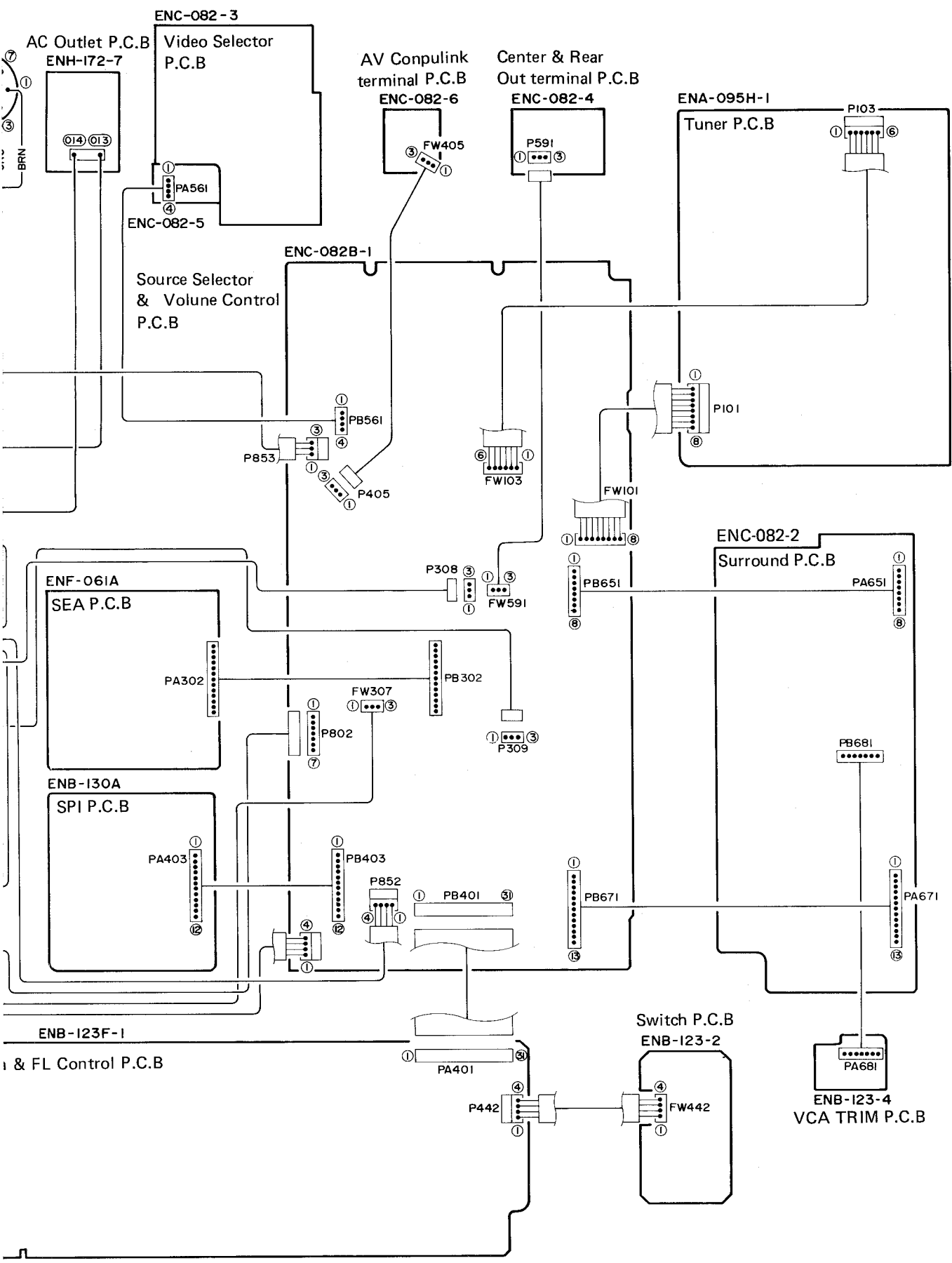

ER SUPPLY

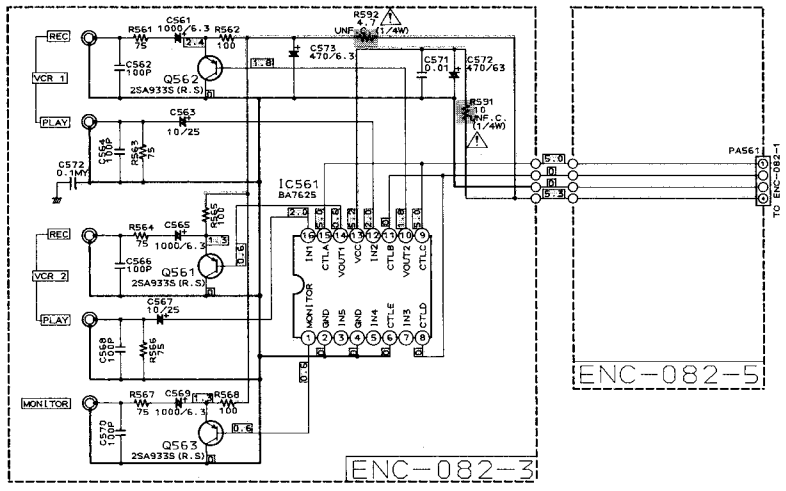
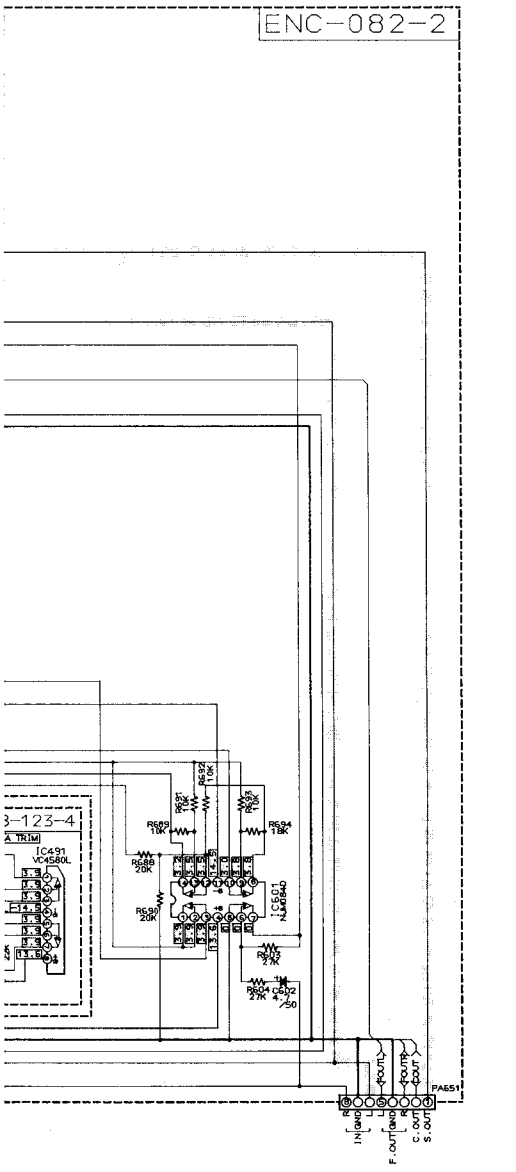
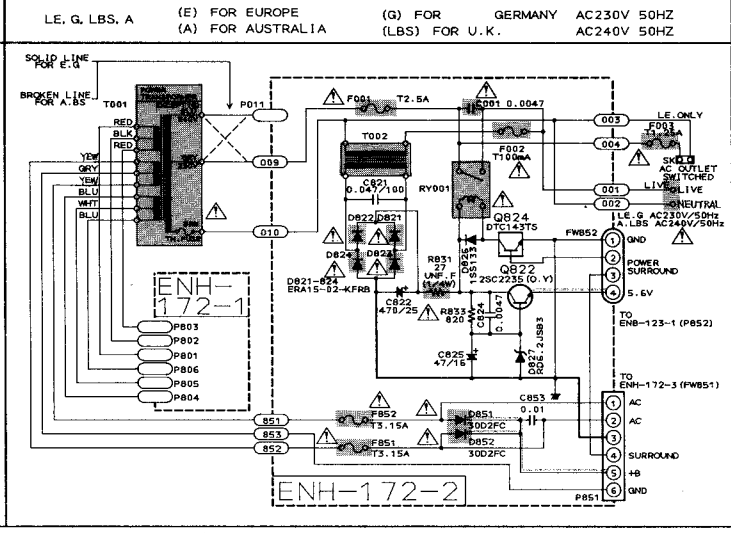
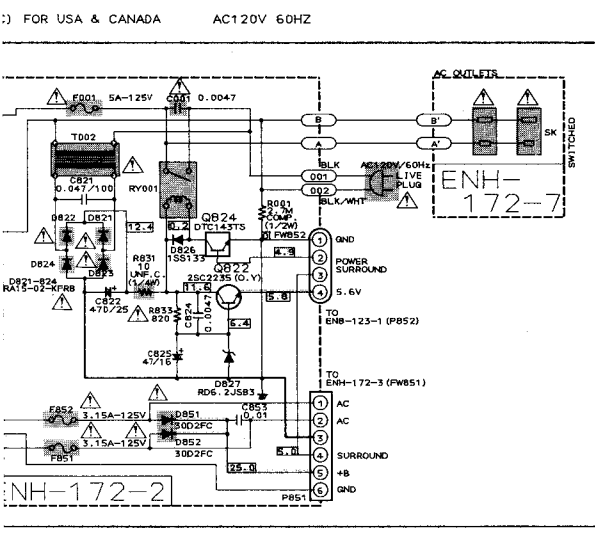

Front Section

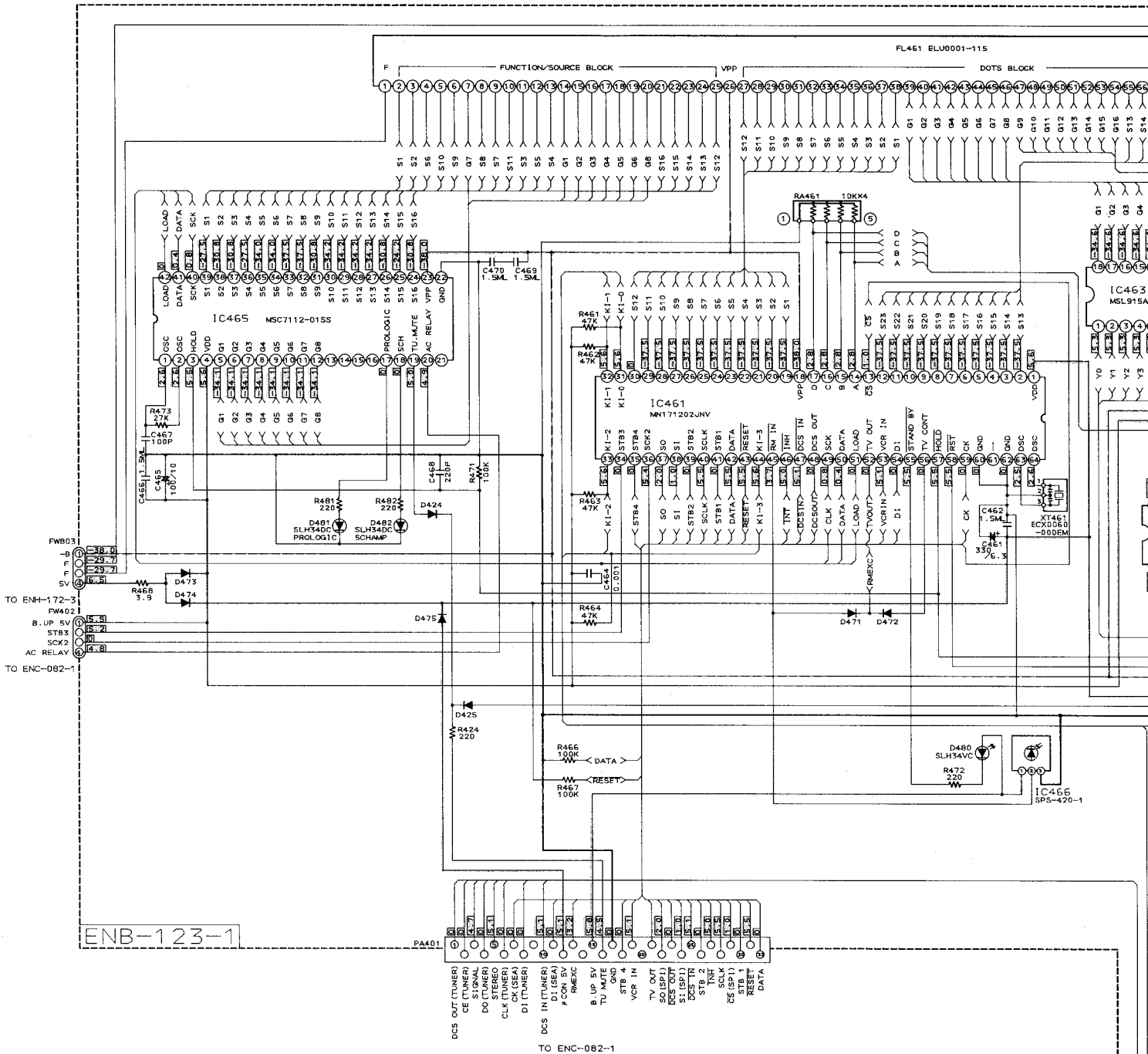

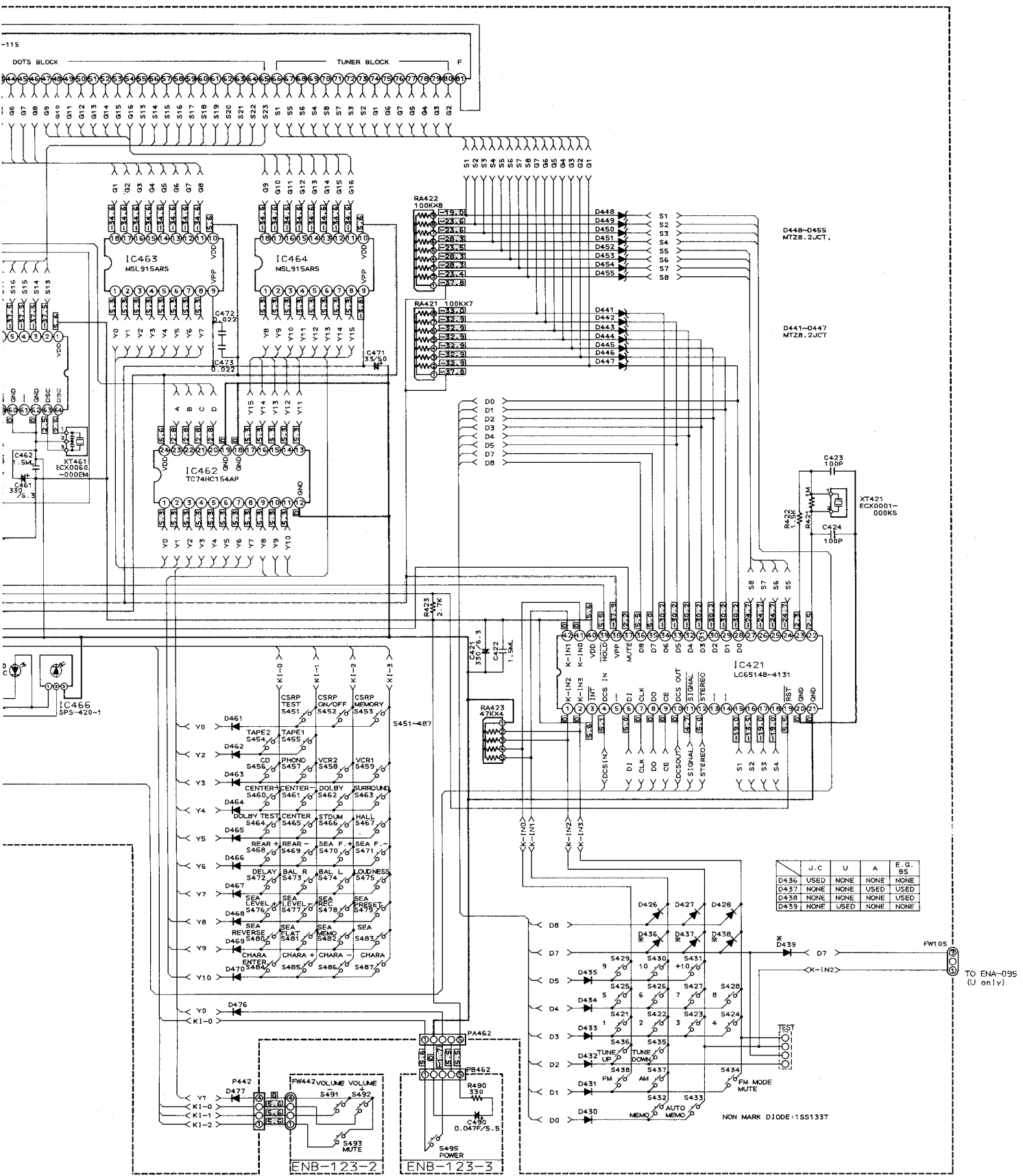

Schematic Diagram

■ Source Select, SEA and Volume Section

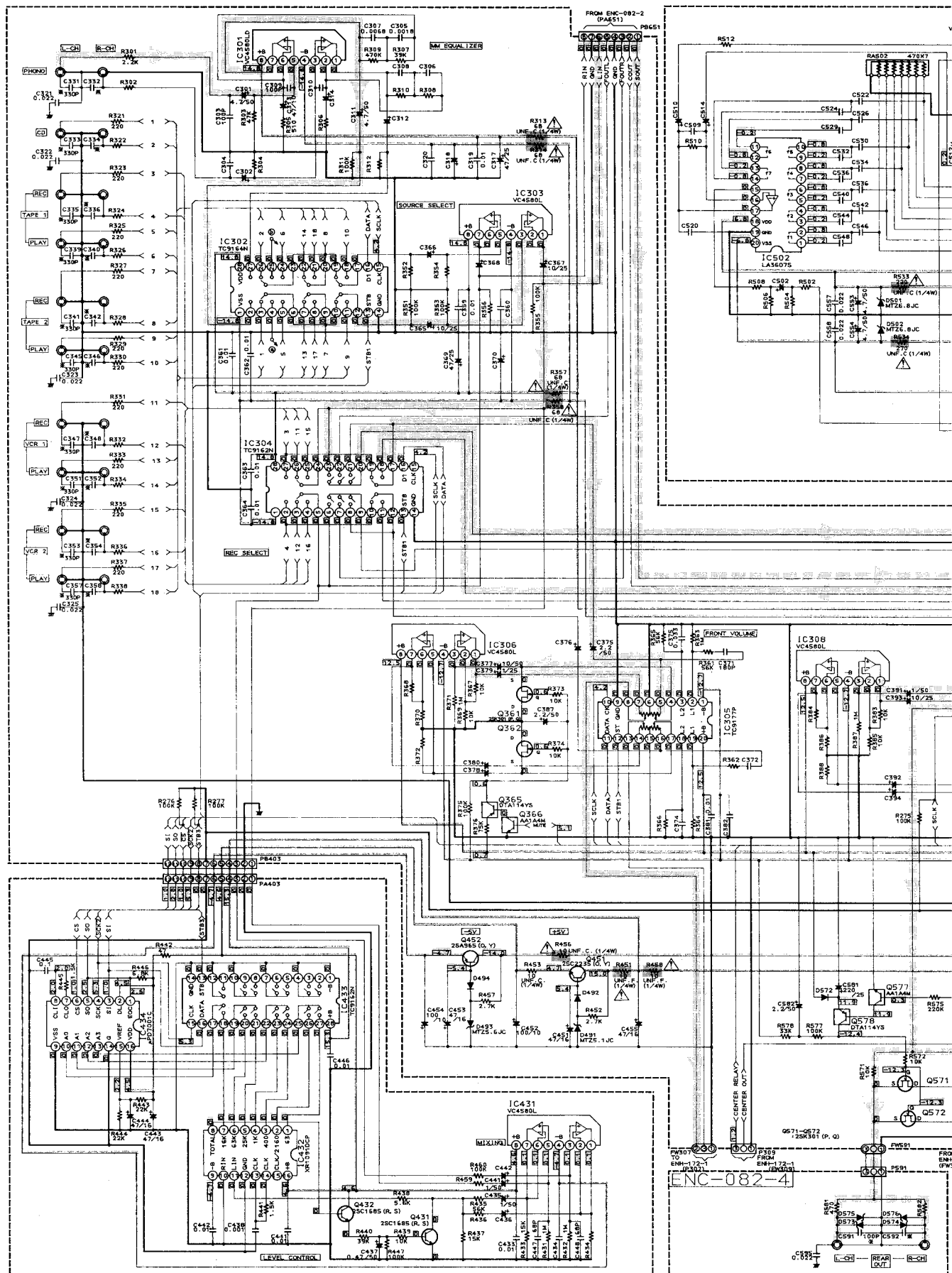

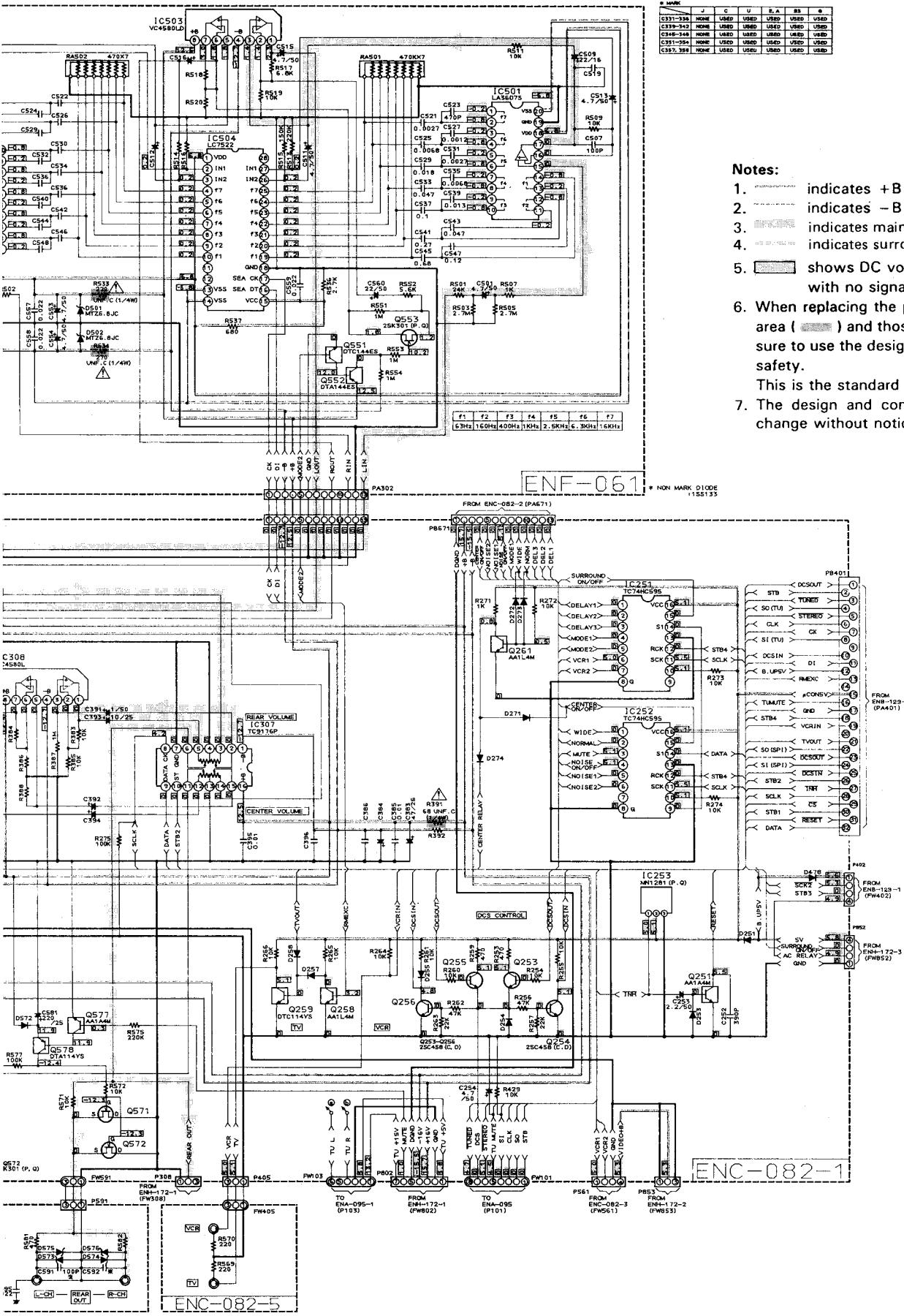

MARK	J	C	U	E.A	RS	Q
C331-338	NONE	USED	USED	USED	USED	USED
C339-342	NONE	USED	USED	USED	USED	USED
C343-346	NONE	USED	USED	USED	USED	USED
C347-354	NONE	USED	USED	USED	USED	USED
C355, 356	NONE	USED	USED	USED	USED	USED

Notes:

1. [Symbol] indicates + B power supply.
2. [Symbol] indicates - B power supply.
3. [Symbol] indicates main signal path.
4. [Symbol] indicates surround signal path.
5. [Symbol] shows DC voltage to the chassis with no signal input.
6. When replacing the parts in the shaded area ([Symbol]) and those marked with Δ , be sure to use the designated parts to ensure safety.
This is the standard circuit diagram.
7. The design and contents are subject to change without notice.

ENF-061 # NON MARK D10DE 155133

ENC-082-1

ENC-082-5

Power Amplifier Section

ENH-172-3

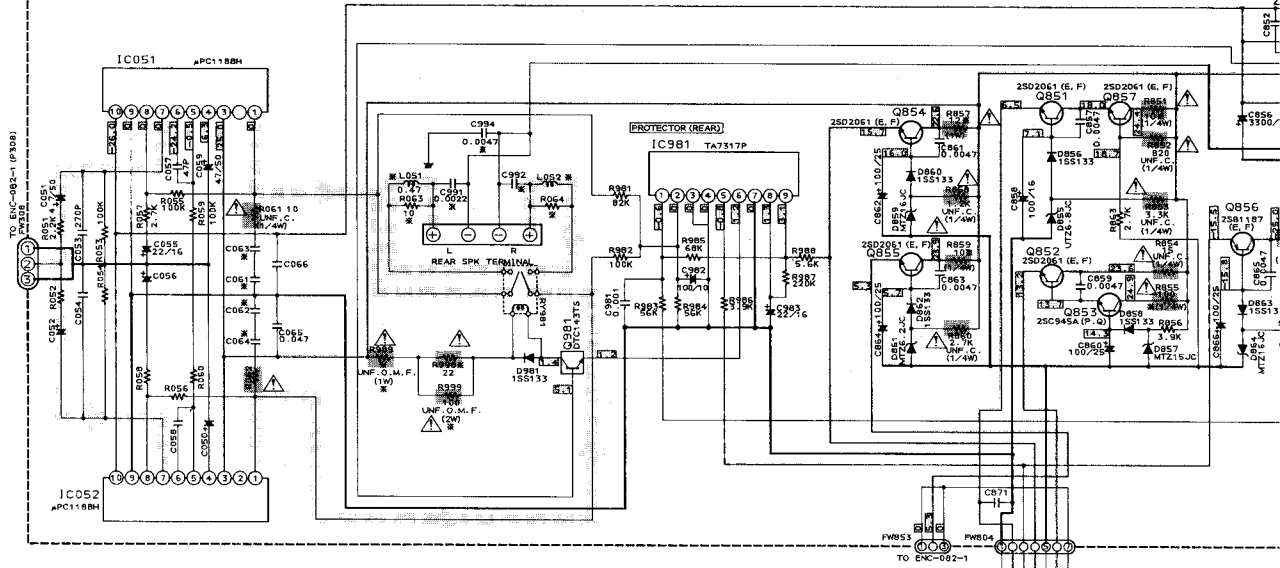

ENH-172-8

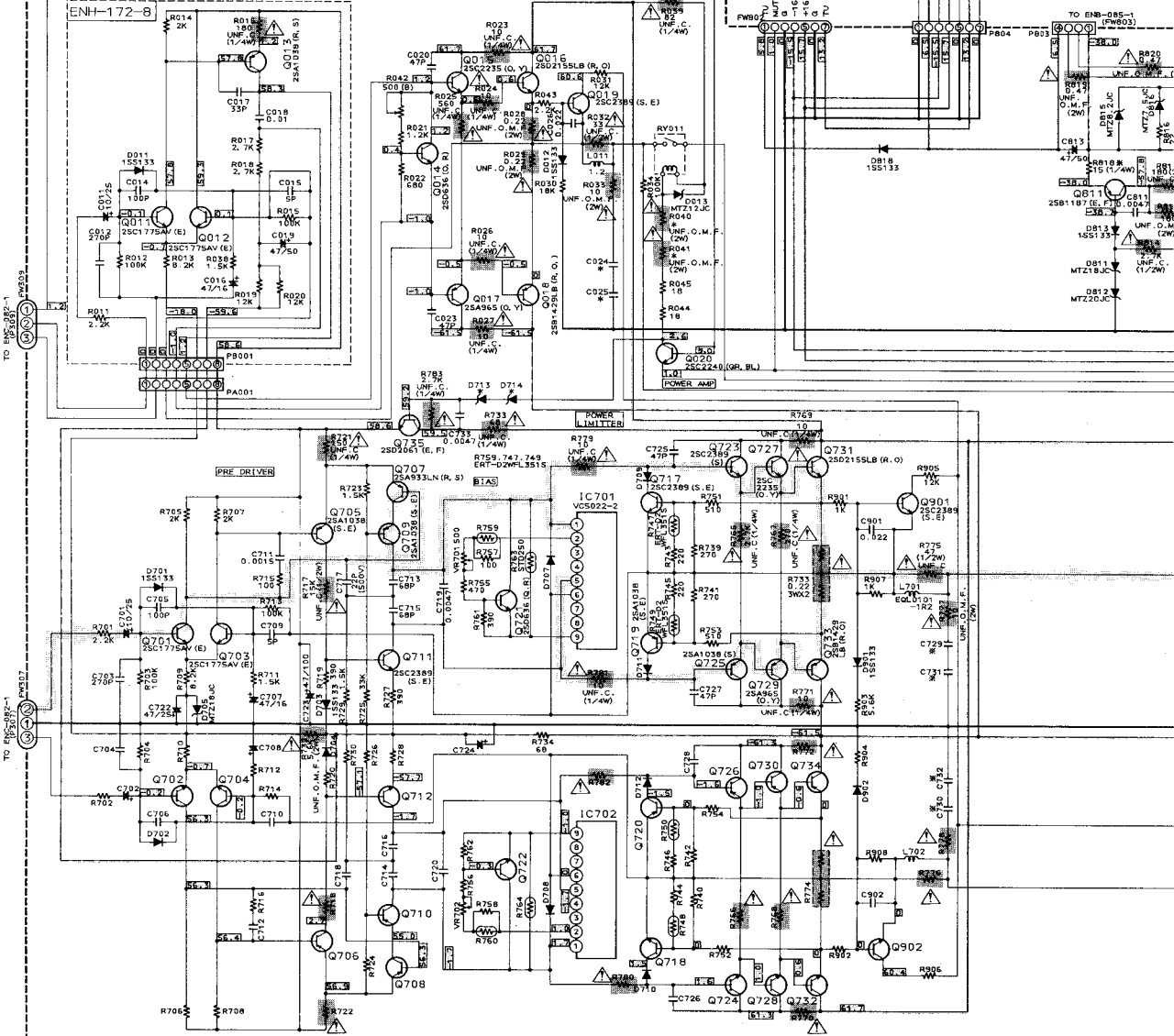

ENH-172-1

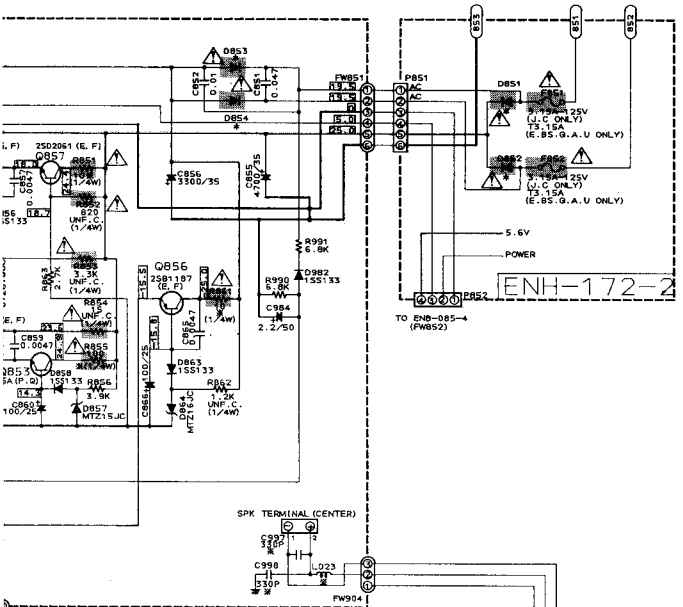

MARK	C (J)	D (C)	E (U, P, PU)	F (L) (L, H, LBS)	I (L, O)
C824	0.022	0.047	0.022	0.047	0.047
C028	SHORT	0.047	SHORT	0.047	0.047
C051, 062	0.022	0.047	0.022	0.047	0.047
C053, 064	SHORT	0.047	SHORT	0.047	0.047
C729, 730	0.022	0.047	0.022	0.047	0.047
C731, 732	SHORT	0.047	SHORT	0.047	0.047
C806	0.01/200V	0.01/200V	0.01/200V	NONE	0.1/160V
C807, C808	NONE	NONE	NONE	NONE	USED
C941-944	NONE	NONE	NONE	NONE	USED
C945-948	NONE	NONE	NONE	NONE	USED
C949-952	NONE	NONE	NONE	NONE	USED
C971-973	NONE	NONE	NONE	NONE	USED
C974, 976	NONE	NONE	NONE	NONE	USED
C991-993	NONE	NONE	NONE	NONE	USED
C997, C998	NONE	NONE	NONE	NONE	USED
R040	330	330	330	330	330
R041	330	330	330	330	330
R063, 064	UNF. C.	UNF. C.	UNF. C.	UNF. F.	UNF. F.
R018	UNF. C.	UNF. C.	UNF. C.	UNF. F.	UNF. F.
R051	UNF. C.	UNF. C.	UNF. C.	UNF. F.	UNF. F.
R055	UNF. C.	UNF. C.	UNF. C.	UNF. F.	UNF. F.
R057, 059	UNF. C.	UNF. C.	UNF. C.	UNF. F.	UNF. F.
R065	UNF. C.	UNF. C.	UNF. C.	UNF. F.	UNF. F.
R924	1.2K	1.2K	1.8K	1.8K	1.8K
R933	NONE	NONE	1.8K	1.8K	1.8K
R925	180	180	150	150	150
R926	180	180	150	150	150
R927	180	180	150	150	150
R928	180	180	150	150	150
R941-944	NONE	NONE	NONE	NONE	USED
R999	220	220	220	39	39
R998	UNF. C.	UNF. C.	UNF. C.	UNF. F.	UNF. F.
R999	USED	USED	USED	NONE	NONE
R999	NONE	NONE	NONE	USED	USED
L023	SHORT	SHORT	SHORT	SHORT	USED
L051, 052	USED	SHORT	SHORT	SHORT	USED
D713	MT218JC	MT218JC	MT218JC	MT218JC	MT218JC
D714	MT215JC	MT215JC	MT215JC	MT215JC	MT215JC
D801-804	300ZFC	300ZFC	300ZFC	300ZFC	300ZFC
D851-854	300ZFC	300ZFC	300ZFC	300ZFC	300ZFC

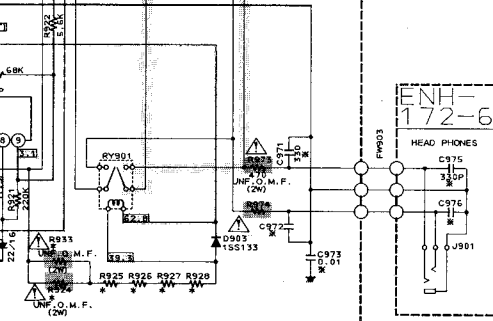
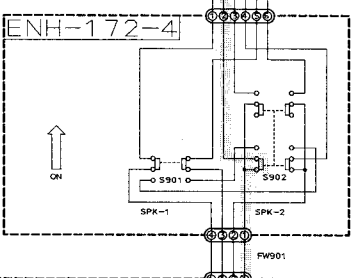
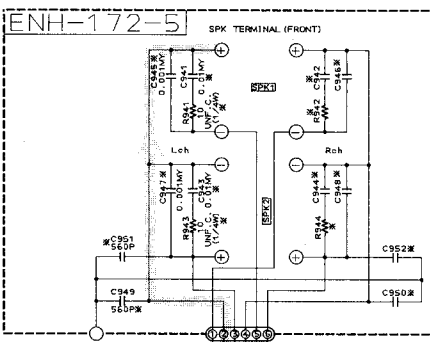
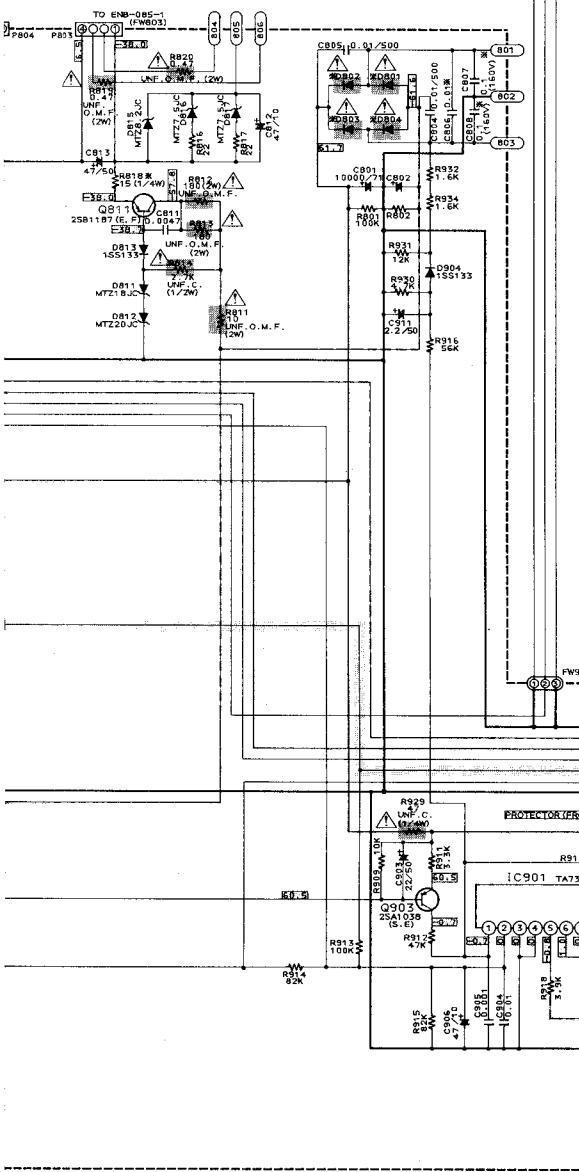

Tuner Section

J.C.U.A

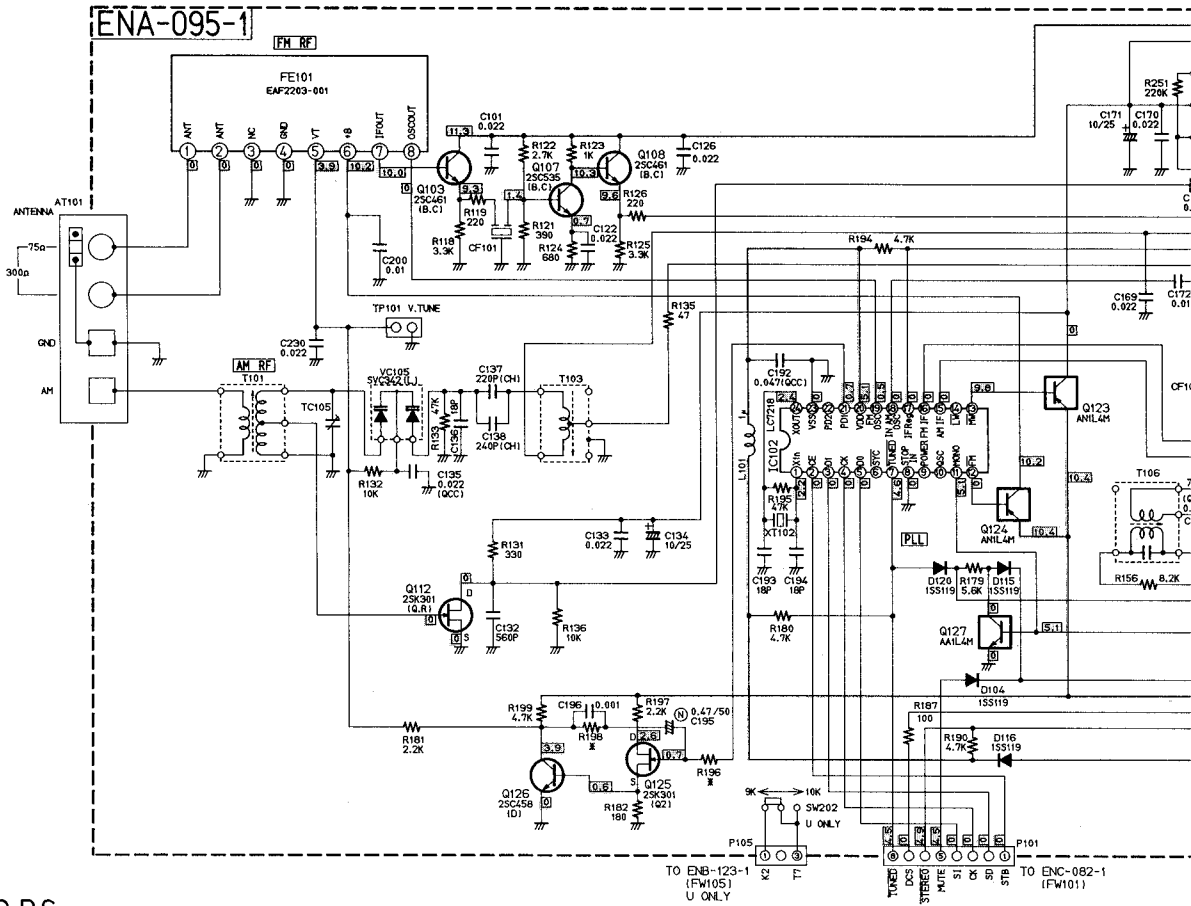

E.G.B.S

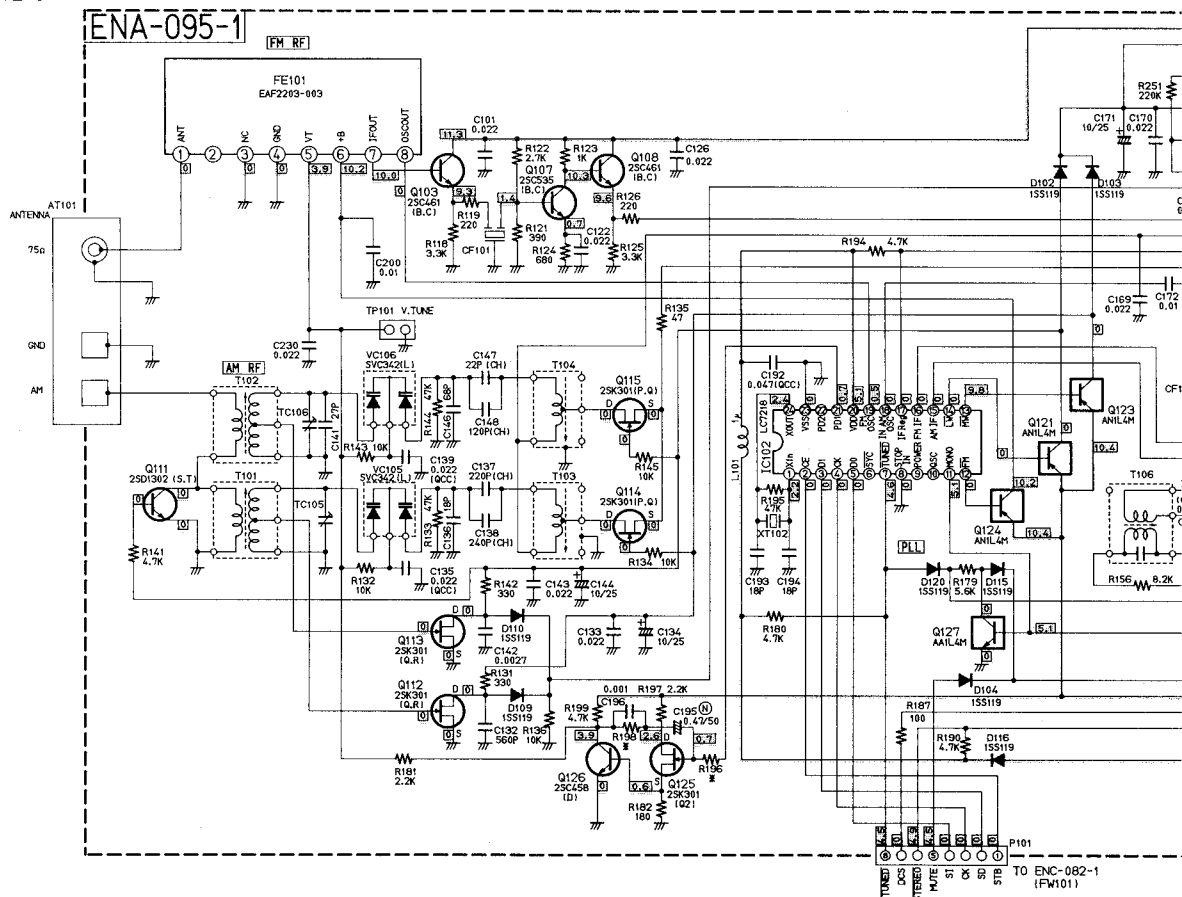

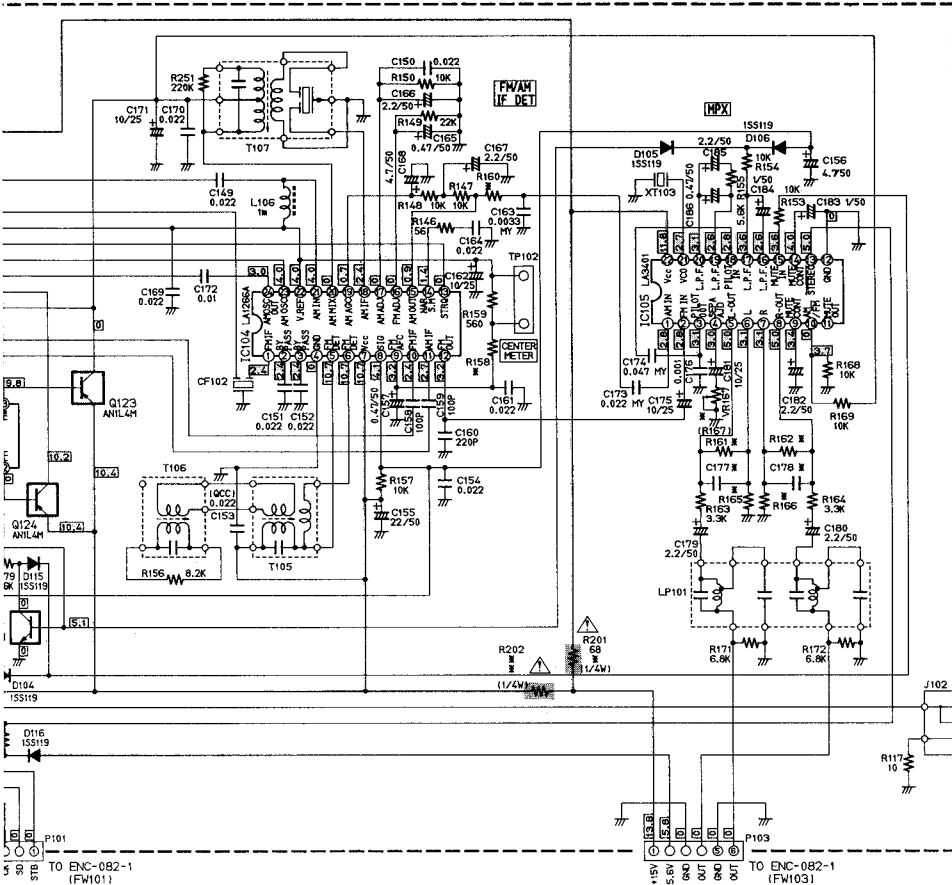

MARK

	J.C	U	A	LE.LBS	LG
R158	18K	27K	27K	27K	27K
R160	12K	12K	22K	22K	22K
R161,162	120K	120K	180K	180K	180K
R165,166	180K	180K	270K	270K	270K
R167,VR167	39K	39K	100K VR	100K VR	100K VR
R196	10K	10K	10K	2.2K	2.2K
R198	3.3K	3.3K	3.3K	8.2K	8.2K
R201	UNF.C.	UNF.C.	UNF.F.	UNF.F.	UNF.F.
R202	47	47	47	22	22
C177,178	560P	560P	270P	270P	270P
C240	NONE	NONE	NONE	NONE	USED

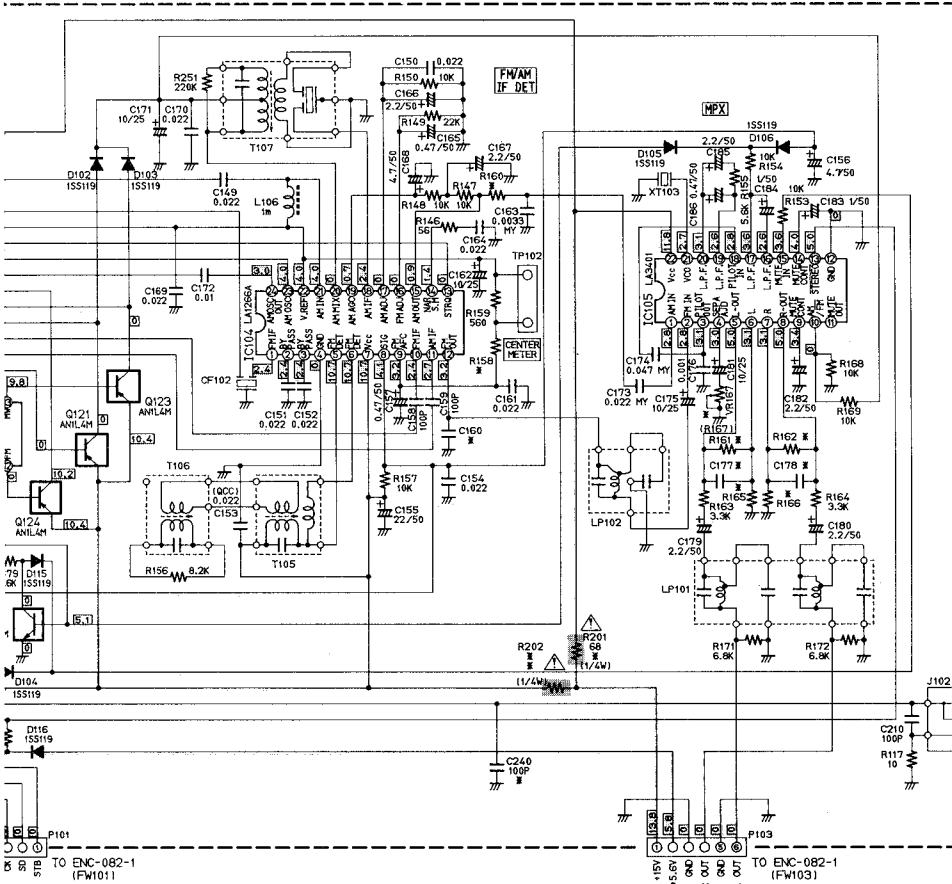

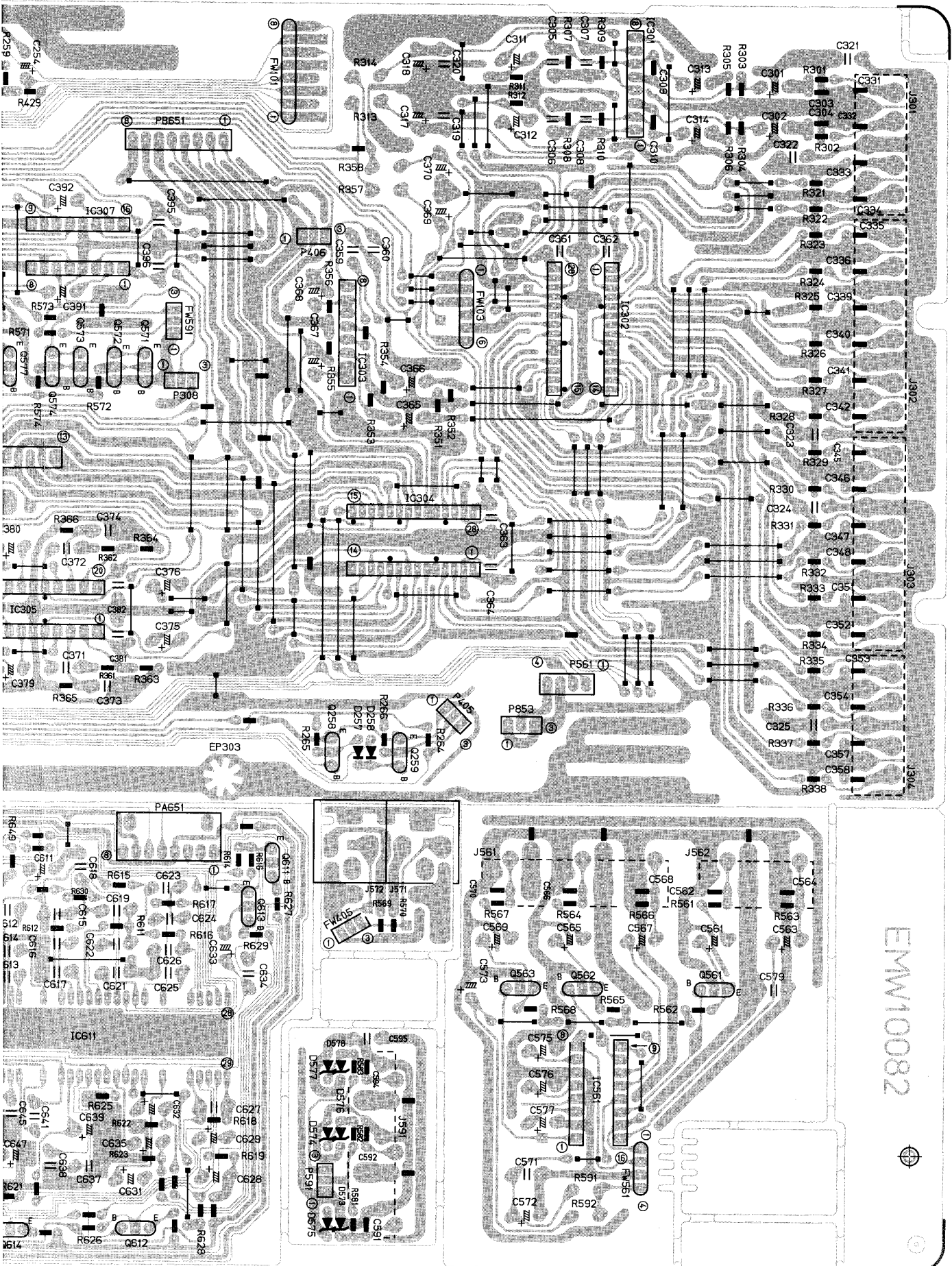

PARTS LIST

Contents

General Exploded View and Parts List	2-3
Printed Circuit Board Ass'y and Parts List	2-7
■ ENH-172 □ Power Amplifier & Power Supply PC Board Ass'y	2-7
■ ENA-095 □ Tuner PC Board Ass'y	2-13
■ ENC-082 □ Source Selector & Surround PC Board Ass'y	2-16
■ ENB-123 □ Control PC Board Ass'y	2-20
■ ENF-061 △ SEA PC Board Ass'y	2-22
■ ENB-130 △ SPI PC Board Ass'y	2-23
Accessories List	2-24
Packing Materials and Part Numbers	2-25

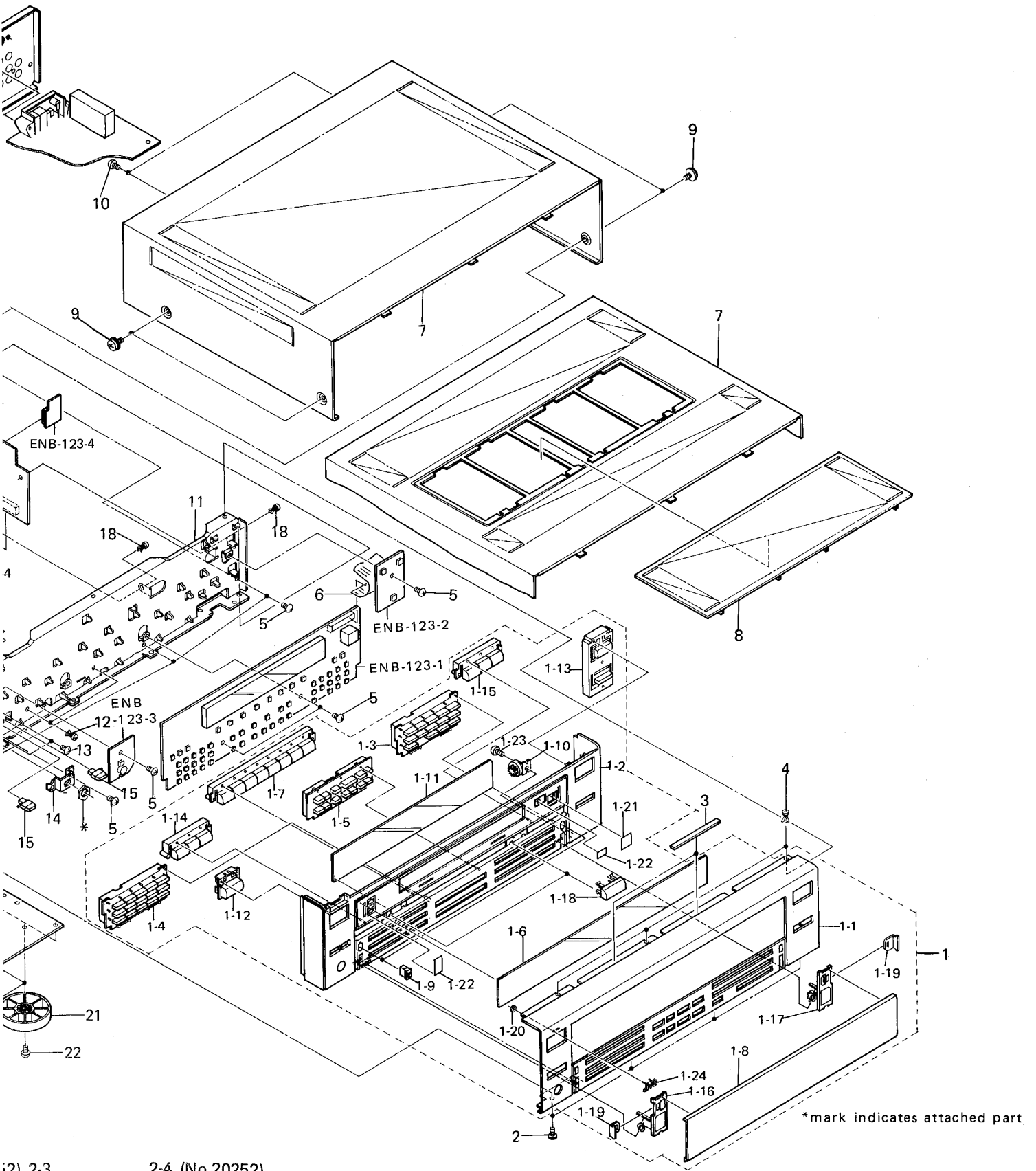

■ Parts List

△	Item	Part Number	Part Name	Q'ty	Description	Areas
	1	EFP-RX805VTNJ	Front Panel Ass'y	1		J, C
		EFP-RX805VTNU	Front Panel Ass'y	1		A, U
	1-1	EFP-RX805VLTNE	Front Panel Ass'y	1		LE, LEF, LG
		E207011-002	Front Panel	1		J, C
		E207011-003	Front Panel	1		A, U
	1-2	E207011-004	Front Panel	1		LE, LEF, LG
	1-3	E102389-001SM	Front Base	1		
	1-4	E206964-001SS	Preset Button	1	Right	
	1-5	E206964-002SS	Push Button	1	Left	
	1-5	E206966-002SS	Push Button	1	SURROUND	
	1-6	E207013-005SM	Window Screen	1		J, C
		E207013-006SM	Window Screen	1		Except J, C
	1-7	E207018-003	Source Button	1		J, C, A, U
		E207018-004	Source Button	1		LE, LEF, LG
	1-8	E207019-001	Door	1		
	1-9	E305513-001	Magnet	2		
	1-10	E305654-003	Damper Ass'y	1		
	1-11	E306679-007SM	FL Screen	1		
	1-12	E307173-002SM	Power Button	1		
	1-13	E307230-001SS	Volume Button	1	TUNING	
	1-14	E307310-001	Push Button	1	Left	
	1-15	E307311-002	Push Button	1	Right	
	1-16	E307312-001	Hinge	1	Left	
	1-17	E307312-002	Hinge	1	Right	
	1-18	E406401-002SS	Cap	2		
	1-19	E406551-001SM	Hinge Plate	2		
	1-20	E60912-003	Speed Nut	1		
	1-21	E72436-006	Screen	1		
	1-22	E72437-006	Sheet	2		
	1-23	SBSF3008Z	Screw	1		
	1-24	E72968-001	JVC Mark	1		
	2	SDSG3008M	Screw	4		Except J, C, U
		SDSG3008M	Screw	6		J, C, U
	3	EXO075005N40S	Spacer	2		
	4	E48729-009	Plastic Rivet	3		
	5	SBSG3008CC	Screw	56		
	6	EWR632E-17TTJ2	Flat Wire	1	FW401	
	7	E25936-006	Metal Cover	1		Except LE, LEF
		E26607-002	Metal Cover	1		LE, LEF
	8	E24134-007	Grill	1		LE, LEF
	9	E61660-004	Special Screw	4		
	10	SBSG3008M	Screw	24		Except U
		SBSG3008M	Screw	26		U
	11	E102390-001SM	Front Bracket	1		
	12	E48729-007	Plastic Rivet	2		
	13	SBST3006CC	Screw	2		
	14	E75143-001SM	Headphone Bracket	1		
	15	E406334-001SS	Speaker Button	2		
	16	E305235-002SM	Side Bracket	1	Right	
	17	E406652-001SM	Holder	1		
	18	E48729-008	Plastic Rivet	4		Except J
		E48729-008	Plastic Rivet	5		J
	19	E11663-006SM	Bottom Plate	1		
	20	E74925-001	Dolby Sheet	1		
	21	VJF4039-00A	Foot Ass'y	4		
	22	SBST3008Z	Screw	4	for Foot	
	23	E70281-001	Caution Label	1		J
		E70115-002	Caution Label	1		Except J, U
	24	E305234-001SM	Side Bracket	1	Left	
	25	E305788-001SM	Center Bracket	1		
	26	E73937-001	Protect Sheet	1		
	27	E26264-004SM	Trans Bracket	1		
	28	E306040-001SM	Circuit Board Bracket	1		
	29	E46891-032	Plate	1		
	30	E306041-001SM	Circuit Board Bracket	1		

⚠	Item	Part Number	Part Name	Q'ty	Description	Areas
⚠	31	ETP1200-50JAJ	Power Transformer	1		J, C
		ETP1200-50FAJ	Power Transformer	1		U
		ETP1200-50EAJ	Power Transformer	1		A, LE, LEF, LG
	32	E306805-030	Spacer	1		
	33	E65389-004	Special Screw	4	for Power Transformer	
⚠	34	E75092-001SM	Sub Heat Sink Bracket	2		
	35	E406632-001	Trans Cover	1		J
	36	QMF51U1-5R0S	Fuse	1	F001	J, C
	37	QMF51E2-2R5J1	Fuse	1	F001	A, LE, LEF, LG
	37	QMF51E2-R10J1	Fuse	1	F002	A, LE, LEF, LG
⚠	38	E302321-001	Fastener	1		Except J, C, U
	39	QMF51U1-3R15S	Fuse	1	F851, F852	J, C
		QMF51E2-3R15J1	Fuse	1	F851, F852	Except J, C
	40	E307309-001SM	Circuit Board Bracket	1		
	41	SDSG3008CC	Screw	1		
⚠	42	E406613-001	Fastener	2		
	43	EMC0233-001	AC Socket	1		A
		EMC0236-001	AC Socket	1		LE, LEF, LG
	44	E406647-001SM	Stopper	1		
	45	E69291-001	Fuse Cover	1		U, LE, LEF
⚠	46	E302764-001	Voltage Selector Cover	1		U
	47	QSR0085-018	Voltage Selector	1		U
	48	E69589-008	Spacer	1		J
	49	EXO085010R10S	Spacer	2		
	50	E207015-002SM	Rear Panel	1		J, C
			E207015-003SM	Rear Panel	1	
		E207015-004SM	Rear Panel	1		A
		E207015-007SM	Rear Panel	1		LG
		E207015-008SM	Rear Panel	1		LE, LEF
		E306019-089	Rating Label	1	Made in Malaysia	U
⚠	51	E306019-092	Rating Label	1		LG
		SBST3006M	Screw	2		Except LG
		SBST3006M	Screw	4		LG
	52	E70078-001	GND Terminal	1		
	53	QMP1D00-200H	Power Cord	1		J, C
⚠		QMP2560-244	Power Cord	1		A
		QMP3900-200	Power Cord	1		LE, LEF
		QMP39A0-200	Power Cord	1		LG
		QMP7520-200	Power Cord	1		U
	54	QHS3876-162	Cord Stopper	1		
			QMG0301-003	Fuse Holder	1	
⚠	56	QMF51E-2R5J1	Fuse	1	F001	U
		QMF51E-1R25J1	Fuse	1	F003	LE, LEF
		E61029-005	Number Label	1		LE, LEF, LG
		E67199-001	Fuse Caution Label	1		J
			E65507-001	Caution Label	1	
		QZL1001-001	UL Label	1		J
		E45858-002	CSA Label	1		C
		E70028-001	Approval Label	1		LE

The Marks for Designated Areas

J.....the U.S.A. LG.....Germany (with LW)
C.....Canada U.....Universal Type
A.....Australia **No mark indicates all areas.**
LE,LEF.....Continental Europe (with LW)

⚠ Safety Parts

Printed Circuit Board Ass'y and Parts List

■ ENH-172 □ Power Amplifier & Power Supply PC Board Ass'y

Note : ENH-172 □ varies according to the areas employed. See note (1) when placing an order.

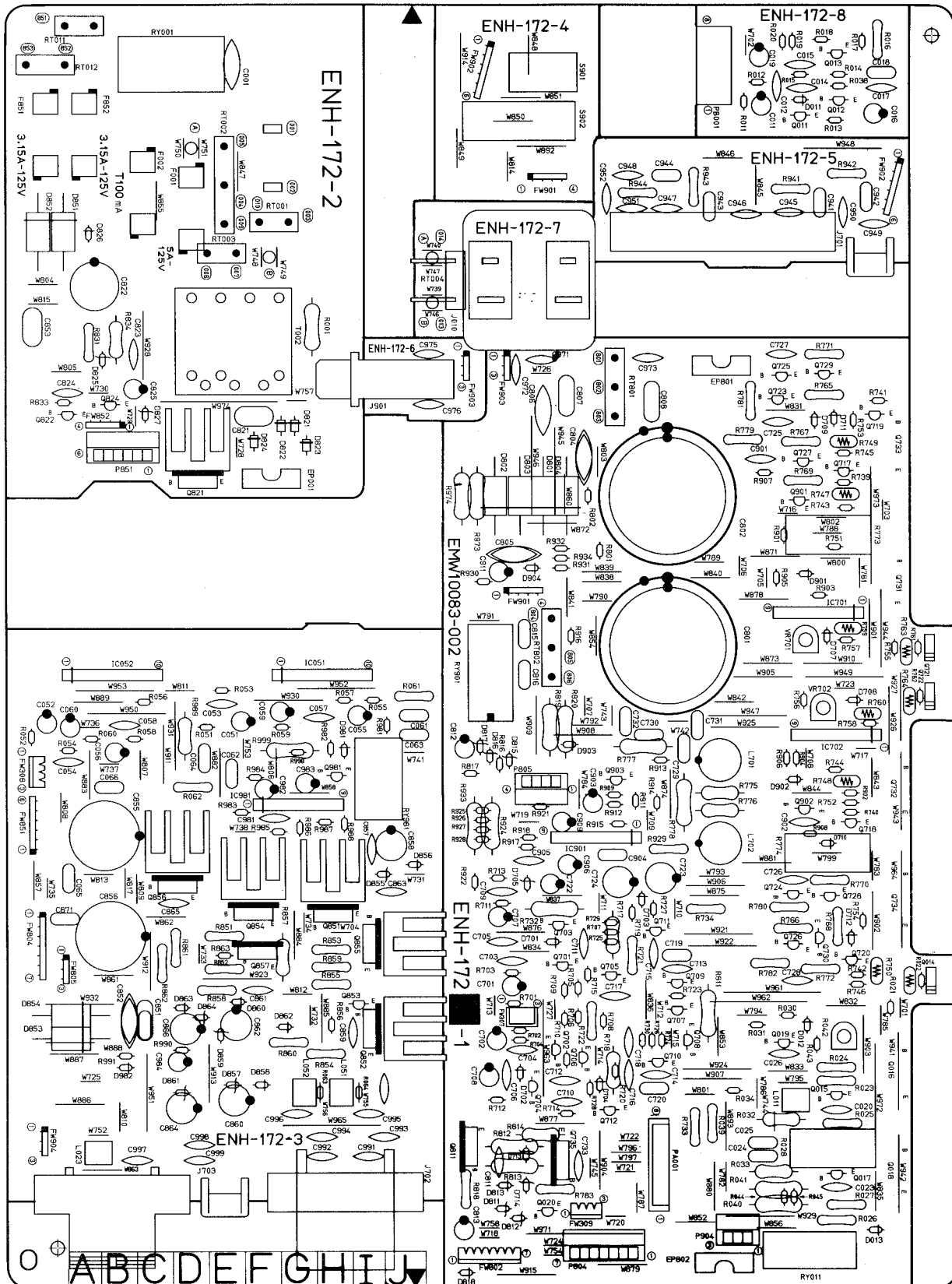

Note (1)

PC Board Ass'y	Designated Areas
ENH-172 C	the U.S.A.
ENH-172 D	Canada
ENH-172 E	Universal Type
ENH-172 F	Continental Europe (with LW)
ENH-172 G	Australia
ENH-172 I	Germany (with LW)

Transistors

Δ	ITEM	PART NUMBER	DESCRIPTION	AREA
	Q011	2SC1775AV(E)	SILICON HITACHI	
	Q012	2SC1775AV(E)	SILICON HITACHI	
	Q013	2SA1038(R,S)	SILICON ROHM	
	Q014	2SD636(Q,R)	SILICON MATSUSHITA	
	Q015	2SC2235(O,Y)	SILICON TOSHIBA	
	Q016	2SD2155LB(R,O)	SILICON TOSHIBA	
	Q017	2SA965(O,Y)	SILICON TOSHIBA	
	Q018	2SB1429LB(R,O)	SILICON TOSHIBA	
	Q019	2SC1775AV(E)	SILICON HITACHI	
	Q020	2SC2240(GR,BL)	SILICON TOSHIBA	
	Q701	2SC1775AV(E)	SILICON HITACHI	
	Q702	2SC1775AV(E)	SILICON HITACHI	
	Q703	2SC1775AV(E)	SILICON HITACHI	
	Q704	2SC1775AV(E)	SILICON HITACHI	
	Q705	2SA1038(S,E)	SILICON ROHM	
	Q706	2SA1038(S,E)	SILICON ROHM	
	Q707	2SA933LN(R,S)	SILICON ROHM	
	Q708	2SA933LN(R,S)	SILICON ROHM	
	Q709	2SA1038(S,E)	SILICON ROHM	
	Q710	2SA1038(S,E)	SILICON ROHM	
	Q711	2SC2389(S,E)	SILICON ROHM	
	Q712	2SC2389(S,E)	SILICON ROHM	
	Q717	2SC2389(S,E)	SILICON ROHM	
	Q718	2SC2389(S,E)	SILICON ROHM	
	Q719	2SA1038(S,E)	SILICON ROHM	
	Q720	2SA1038(S,E)	SILICON ROHM	
	Q721	2SD636(Q,R)	SILICON MATSUSHITA	
	Q722	2SD636(Q,R)	SILICON MATSUSHITA	
	Q723	2SC2389(S)	SILICON ROHM	
	Q724	2SC2389(S)	SILICON ROHM	
	Q725	2SA1038(S)	SILICON ROHM	
	Q726	2SA1038(S)	SILICON ROHM	
	Q727	2SC2235(O,Y)	SILICON TOSHIBA	
	Q728	2SC2235(O,Y)	SILICON TOSHIBA	
	Q729	2SA965(O,Y)	SILICON TOSHIBA	
	Q730	2SA965(O,Y)	SILICON TOSHIBA	
	Q731	2SD2155LB(R,O)	SILICON TOSHIBA	
	Q732	2SD2155LB(R,O)	SILICON TOSHIBA	
	Q733	2SB1429LB(R,O)	SILICON TOSHIBA	
	Q734	2SB1429LB(R,O)	SILICON TOSHIBA	
	Q735	2SD2061(E,F)	SILICON ROHM	
	Q811	2SB1187(E,F)	SILICON ROHM	
	Q821	2SD1266(P,Q)	SILICON MATSUSHITA	E
	Q822	2SC2235(O,Y)	SILICON TOSHIBA	
	Q824	DTC143TS	SILICON ROHM	
	Q851	2SD2061(E,F)	SILICON ROHM	
	Q852	2SD2061(E,F)	SILICON ROHM	
	Q853	2SC945A(P,Q)	SILICON NEC	
	Q854	2SD2061(E,F)	SILICON ROHM	
	Q855	2SD2061(E,F)	SILICON ROHM	
	Q856	2SB1187(E,F)	SILICON ROHM	
	Q857	2SD2061(E,F)	SILICON ROHM	
	Q901	2SC2389(S,E)	SILICON ROHM	
	Q902	2SC2389(S,E)	SILICON ROHM	
	Q903	2SA1038(S,E)	SILICON ROHM	
	Q981	DTC143TS	SILICON ROHM	

Δ SAFETY PARTS

I.C.s

Δ	ITEM	PART NUMBER	DESCRIPTION	AREA
	IC051	UPC1188H	I.C. NEC	
	IC052	UPC1188H	I.C. NEC	
	IC701	VC5022-2	I.C. SANYO	
	IC702	VC5022-2	I.C. SANYO	
	IC901	TA7317P	I.C. TOSHIBA	
	IC981	TA7317P	I.C. TOSHIBA	

Δ SAFETY PARTS

Diodes

Δ	ITEM	PART NUMBER	DESCRIPTION	AREA
	D011	1SS133	SILICON ROHM	
	D012	1SS133	SILICON ROHM	
	D013	MTZ12JC	ZENER ROHM	
	D701	1SS133	SILICON ROHM	
	D702	1SS133	SILICON ROHM	
	D703	1SS133	SILICON ROHM	
	D704	1SS133	SILICON ROHM	
	D705	MTZ18JC	ZENER ROHM	
	D707	1SS133	SILICON ROHM	
	D708	1SS133	SILICON ROHM	
	D709	1SS133	SILICON ROHM	
	D710	1SS133	SILICON ROHM	
	D711	1SS133	SILICON ROHM	
	D712	1SS133	SILICON ROHM	
	D713	MTZ18JC	ZENER ROHM	
	D714	MTZ15JC	ZENER ROHM	C
	D714	MTZ15JC	ZENER ROHM	D
	D714	MTZ12JC	ZENER ROHM	E
	D714	MTZ12JC	ZENER ROHM	F
	D714	MTZ12JC	ZENER ROHM	G
	D714	MTZ12JC	ZENER ROHM	I
	D801	30DL2FC	SILICON NIHONINTER	C
	D801	30DL2FC	SILICON NIHONINTER	D
	D801	30DL2FC	SILICON NIHONINTER	E
	D801	30DF2SFC	SILICON NIHONINTER	F
	D801	30DF2SFC	SILICON NIHONINTER	G
	D801	30DF2SFC	SILICON NIHONINTER	I
	D802	30DL2FC	SILICON NIHONINTER	C
	D802	30DL2FC	SILICON NIHONINTER	D
	D802	30DL2FC	SILICON NIHONINTER	E
	D802	30DF2SFC	SILICON NIHONINTER	F
	D802	30DF2SFC	SILICON NIHONINTER	G
	D802	30DF2SFC	SILICON NIHONINTER	I
	D803	30DL2FC	SILICON NIHONINTER	D
	D803	30DL2FC	SILICON NIHONINTER	E
	D803	30DF2SFC	SILICON NIHONINTER	F
	D803	30DF2SFC	SILICON NIHONINTER	G
	D803	30DF2SFC	SILICON NIHONINTER	I
	D804	30DL2FC	SILICON NIHONINTER	C
	D804	30DL2FC	SILICON NIHONINTER	D
	D804	30DL2FC	SILICON NIHONINTER	E
	D804	30DF2SFC	SILICON NIHONINTER	F
	D804	30DF2SFC	SILICON NIHONINTER	G
	D804	30DF2SFC	SILICON NIHONINTER	I
	D811	MTZ18JC	ZENER ROHM	
	D812	MTZ20JC	ZENER ROHM	
	D813	1SS133	SILICON ROHM	
	D815	MTZ8.2JC	ZENER ROHM	
	D816	MTZ7.5JC	ZENER ROHM	
	D817	MTZ7.5JC	ZENER ROHM	
	D818	1SS133	SILICON ROHM	
	D821	1SR139-200	SILICON ROHM	
	D822	1SR139-200	SILICON ROHM	
	D823	1SR139-200	SILICON ROHM	
	D824	1SR139-200	SILICON ROHM	
	D825	MTZ12JC	ZENER ROHM	E
	D826	1SS133	SILICON ROHM	C
	D826	1SS133	SILICON ROHM	D
	D826	1SS133	SILICON ROHM	E
	D826	MTZ12JC	ZENER ROHM	F
	D826	MTZ12JC	ZENER ROHM	G
	D826	1SS133	SILICON ROHM	I
	D827	RD6.2JSB3	ZENER NEC	
	D851	30D2FC	SILICON NIHONINTER	C
	D851	30D2FC	SILICON NIHONINTER	D
	D851	30D2FC	SILICON NIHONINTER	E
	D851	30D2FC	SILICON NIHONINTER	F
	D851	30D2FC	SILICON NIHONINTER	G
	D851	30DF2SFC	SILICON NIHONINTER	I
	D852	30D2FC	SILICON NIHONINTER	C
	D852	30D2FC	SILICON NIHONINTER	D
	D852	30D2FC	SILICON NIHONINTER	E
	D852	30D2FC	SILICON NIHONINTER	F
	D852	30D2FC	SILICON NIHONINTER	G
	D852	30DF2SFC	SILICON NIHONINTER	I
	D853	30D2FC	SILICON NIHONINTER	C
	D853	30D2FC	SILICON NIHONINTER	D
	D853	30D2FC	SILICON NIHONINTER	E
	D853	30D2FC	SILICON NIHONINTER	F
	D853	30D2FC	SILICON NIHONINTER	G
	D853	30DF2SFC	SILICON NIHONINTER	I
	D854	30D2FC	SILICON NIHONINTER	C
	D854	30D2FC	SILICON NIHONINTER	D
	D854	30D2FC	SILICON NIHONINTER	E
	D854	30D2FC	SILICON NIHONINTER	F
	D854	30D2FC	SILICON NIHONINTER	G
	D854	30DF2SFC	SILICON NIHONINTER	I
	D855	UTZ6.8JC	ZENER ROHM	
	D856	1SS133	SILICON ROHM	
	D857	MTZ15JC	ZENER ROHM	
	D858	1SS133	SILICON ROHM	
	D859	MTZ16JC	ZENER ROHM	
	D860	1SS133	SILICON ROHM	
	D861	MTZ6.2JC	ZENER ROHM	

Δ SAFETY PARTS

Diodes

Δ	ITEM	PART NUMBER	DESCRIPTION	AREA
	D862	1SS133	SILICON ROHM	
	D863	1SS133	SILICON ROHM	
	D864	MTZ16JC	ZENER ROHM	
	D901	1SS133	SILICON ROHM	
	D902	1SS133	SILICON ROHM	
	D903	1SS133	SILICON ROHM	
	D904	1SS133	SILICON ROHM	
	D981	MTZ13JC	ZENER ROHM	
	D982	1SS133	SILICON ROHM	

▲ DISASSEMBLY PARTS

Capacitors

Δ	ITEM	PART NUMBER	DESCRIPTION	AREA
	C001	QCZ9019-472	4700PF CERAMIC	
	C011	QETB1HM-106	10MF 50V ELECTRO	
	C012	QCS21HJ-271	270PF 50V CERAMIC	
	C014	QCS21HJ-101	100PF 50V CERAMIC	
	C015	QCS21HJ-5R0	5PF 50V CERAMIC	
	C016	QETB1CM-476	47MF 16V ELECTRO	
	C017	QCS21HJ-330	33PF 50V CERAMIC	
	C018	QFLB1HK-103	0.01MF 50V MYLAR	
	C019	QETB1HM-476	47MF 50V ELECTRO	
	C020	QCS21HJ-470	47PF 50V CERAMIC	
	C023	QCS21HJ-470	47PF 50V CERAMIC	
	C024	QFLB1HK-223	0.022MF 50V MYLAR	C
	C024	QFLB1HK-473	0.047MF 50V MYLAR	D
	C024	QFLB1HK-473	0.047MF 50V MYLAR	E
	C024	QFLB1HK-473	0.047MF 50V MYLAR	F
	C024	QFLB1HK-473	0.047MF 50V MYLAR	G
	C024	QFLB1HK-473	0.047MF 50V MYLAR	I
	C025	QFLB1HK-473	0.047MF 50V MYLAR	D
	C025	QFLB1HK-473	0.047MF 50V MYLAR	E
	C025	QFLB1HK-473	0.047MF 50V MYLAR	F
	C025	QFLB1HK-473	0.047MF 50V MYLAR	G
	C025	QFLB1HK-473	0.047MF 50V MYLAR	I
	C026	QCF21HP-223	0.022MF 50V CERAMIC	
	C051	QFLB1HK-333	0.033MF 50V MYLAR	C
	C051	QETB1HM-475	4.7MF 50V ELECTRO	D
	C051	QETB1HM-475	4.7MF 50V ELECTRO	E
	C051	QETB1HM-475	4.7MF 50V ELECTRO	F
	C051	QETB1HM-475	4.7MF 50V ELECTRO	G
	C051	QETB1HM-475	4.7MF 50V ELECTRO	I
	C052	QFLB1HK-333	0.033MF 50V MYLAR	C
	C052	QETB1HM-475	4.7MF 50V ELECTRO	D
	C052	QETB1HM-475	4.7MF 50V ELECTRO	E
	C052	QETB1HM-475	4.7MF 50V ELECTRO	F
	C052	QETB1HM-475	4.7MF 50V ELECTRO	G
	C052	QETB1HM-475	4.7MF 50V ELECTRO	I
	C053	QCS21HJ-271	270PF 50V CERAMIC	
	C054	QCS21HJ-271	270PF 50V CERAMIC	
	C055	QETB1CM-226	22MF 16V ELECTRO	
	C056	QETB1CM-226	22MF 16V ELECTRO	
	C057	QCS21HJ-470	47PF 50V CERAMIC	
	C058	QCS21HJ-470	47PF 50V CERAMIC	
	C059	QETB1HM-476	47MF 50V ELECTRO	
	C060	QETB1HM-476	47MF 50V ELECTRO	
	C061	QFLB1HK-223	0.022MF 50V MYLAR	C
	C061	QFLB1HK-473	0.047MF 50V MYLAR	D
	C061	QFLB1HK-473	0.047MF 50V MYLAR	E
	C061	QFLB1HK-473	0.047MF 50V MYLAR	G
	C061	QFLB1HK-473	0.047MF 50V MYLAR	I
	C062	QFLB1HK-223	0.022MF 50V MYLAR	C
	C062	QFLB1HK-473	0.047MF 50V MYLAR	D
	C062	QFLB1HK-473	0.047MF 50V MYLAR	E
	C062	QFLB1HK-473	0.047MF 50V MYLAR	F
	C062	QFLB1HK-473	0.047MF 50V MYLAR	G
	C062	QFLB1HK-473	0.047MF 50V MYLAR	I
	C063	QFLB1HK-473	0.047MF 50V MYLAR	D
	C063	QFLB1HK-473	0.047MF 50V MYLAR	E
	C063	QFLB1HK-473	0.047MF 50V MYLAR	F
	C063	QFLB1HK-473	0.047MF 50V MYLAR	G
	C063	QFLB1HK-473	0.047MF 50V MYLAR	I
	C064	QFLB1HK-473	0.047MF 50V MYLAR	D
	C064	QFLB1HK-473	0.047MF 50V MYLAR	E
	C064	QFLB1HK-473	0.047MF 50V MYLAR	F
	C064	QFLB1HK-473	0.047MF 50V MYLAR	G
	C064	QFLB1HK-473	0.047MF 50V MYLAR	I
	C065	QFLB1HK-473	0.047MF 50V MYLAR	
	C066	QFLB1HK-473	0.047MF 50V MYLAR	
	C067	QCS21HJ-331	330PF 50V CERAMIC	I
	C068	QCS21HJ-331	330PF 50V CERAMIC	I
	C701	EEZ5003-106	10MF ELECTRO	
	C702	EEZ5003-106	10MF ELECTRO	
	C703	QCS21HJ-271	270PF 50V CERAMIC	
	C704	QCS21HJ-271	270PF 50V CERAMIC	
	C705	QCS21HJ-101	100PF 50V CERAMIC	
	C706	QCS21HJ-101	100PF 50V CERAMIC	

▲ DISASSEMBLY PARTS

Capacitors

Δ	ITEM	PART NUMBER	DESCRIPTION	AREA
	C707	QETB1CM-107	100MF 16V ELECTRO	
	C708	QETB1CM-107	100MF 16V ELECTRO	
	C709	QCS21HJ-5R0	5PF 50V CERAMIC	
	C710	QCS21HJ-5R0	5PF 50V CERAMIC	
	C711	QCY21HK-152	1500PF 50V CERAMIC	
	C712	QCY21HK-152	1500PF 50V CERAMIC	
	C713	QCS21HJ-680	68PF 50V CERAMIC	
	C714	QCS21HJ-680	68PF 50V CERAMIC	
	C715	QCS21HJ-680	68PF 50V CERAMIC	
	C716	QCS21HJ-680	68PF 50V CERAMIC	
	C717	QCS22HJ-220	22PF 500V CERAMIC	
	C718	QCS22HJ-220	22PF 500V CERAMIC	
	C719	QFLB1HK-472	4700PF 50V MYLAR	
	C720	QFLB1HK-472	4700PF 50V MYLAR	
	C722	QETB1EM-476	47MF 25V ELECTRO	
	C723	QETB2AM-476	47MF 100V ELECTRO	
	C724	QETB2AM-476	47MF 100V ELECTRO	
	C725	QCS22HJ-470A	47PF 500V CERAMIC	
	C726	QCS22HJ-470A	47PF 500V CERAMIC	
	C727	QCS22HJ-470A	47PF 500V CERAMIC	
	C728	QCS22HJ-470A	47PF 500V CERAMIC	
	C729	QFLB1HK-223	0.022MF 50V MYLAR	C
	C729	QFLB1HK-473	0.047MF 50V MYLAR	D
	C729	QFLB1HK-473	0.047MF 50V MYLAR	E
	C729	QFLB1HK-473	0.047MF 50V MYLAR	F
	C729	QFLB1HK-473	0.047MF 50V MYLAR	G
	C729	QFLB1HK-473	0.047MF 50V MYLAR	I
	C730	QFLB1HK-223	0.022MF 50V MYLAR	C
	C730	QFLB1HK-473	0.047MF 50V MYLAR	D
	C730	QFLB1HK-473	0.047MF 50V MYLAR	E
	C730	QFLB1HK-473	0.047MF 50V MYLAR	F
	C730	QFLB1HK-473	0.047MF 50V MYLAR	G
	C730	QFLB1HK-473	0.047MF 50V MYLAR	I
	C731	QFLB1HK-473	0.047MF 50V MYLAR	D
	C731	QFLB1HK-473	0.047MF 50V MYLAR	E
	C731	QFLB1HK-473	0.047MF 50V MYLAR	F
	C731	QFLB1HK-473	0.047MF 50V MYLAR	G
	C731	QFLB1HK-473	0.047MF 50V MYLAR	I
	C731	QFLB1HK-473	0.047MF 50V MYLAR	
	C732	QFLB1HK-473	0.047MF 50V MYLAR	D
	C732	QFLB1HK-473	0.047MF 50V MYLAR	E
	C732	QFLB1HK-473	0.047MF 50V MYLAR	F
	C732	QFLB1HK-473	0.047MF 50V MYLAR	G
	C732	QFLB1HK-473	0.047MF 50V MYLAR	I
	C733	QCF21HP-472	4700PF 50V CERAMIC	
	C801	EEW7103-109T	10000MF ELECTRO	
	C802	EEW7103-109T	10000MF ELECTRO	
	C804	QCE22HP-103	0.01MF 500V CERAMIC	C
	C804	QCE22HP-103	0.01MF 500V CERAMIC	D
	C804	QCE22HP-103	0.01MF 500V CERAMIC	E
	C804	QCE22HP-103	0.01MF 500V CERAMIC	F
	C804	QCE22HP-103	0.01MF 500V CERAMIC	G
	C804	QCE22HP-103	0.01MF 500V CERAMIC	I
	C804	QFN82CK-104	0.1MF 160V MYLAR	C
	C805	QCE22HP-103	0.01MF 500V CERAMIC	D
	C805	QCE22HP-103	0.01MF 500V CERAMIC	E
	C805	QCE22HP-103	0.01MF 500V CERAMIC	F
	C805	QCE22HP-103	0.01MF 500V CERAMIC	G
	C805	QCE22HP-103	0.01MF 500V CERAMIC	I
	C805	QCE22HP-103	0.01MF 500V CERAMIC	
	C806	QCE22HP-103	0.01MF 500V CERAMIC	C
	C806	QCE22HP-103	0.01MF 500V CERAMIC	D
	C806	QCE22HP-103	0.01MF 500V CERAMIC	E
	C806	QFN82CK-104	0.1MF 160V MYLAR	I
	C807	QFN82CK-104	0.1MF 160V MYLAR	I
	C808	QFN82CK-104	0.1MF 160V MYLAR	I
	C811	QCF21HP-472	4700PF 50V CERAMIC	
	C812	QETB1AM-476	47MF 10V ELECTRO	
	C813	QETB1HM-476	47MF 50V ELECTRO	
	C815	QFN81HK-473	0.047MF 50V MYLAR	
	C816	QFN81HK-473	0.047MF 50V MYLAR	
	C821	QFN82AK-473	0.047MF 100V MYLAR	
	C822	QETB1EM-477	470MF 25V ELECTRO	C
	C822	QETB1EM-477	470MF 25V ELECTRO	D
	C822	QETB1JM-227	220MF 63V ELECTRO	E
	C822	QETB1EM-477	470MF 25V ELECTRO	F
	C822	QETB1EM-477	470MF 25V ELECTRO	G
	C822	QETB1EM-477	470MF 25V ELECTRO	I
	C823	QCF21HP-472	4700PF 50V CERAMIC	E
	C824	QCF21HP-472	4700PF 50V CERAMIC	
	C825	QETB1CM-476	47MF 16V ELECTRO	
	C851	QFN82AK-473	0.047MF 100V MYLAR	C
	C851	QFN82AK-473	0.047MF 100V MYLAR	D
	C851	QFN82AK-473	0.047MF 100V MYLAR	E
	C851	QFN82AK-473	0.047MF 100V MYLAR	F
	C851	QFN82AK-473	0.047MF 100V MYLAR	G
	C851	QFN82AK-473	0.047MF 100V MYLAR	I
	C851	QFN32AK-104	0.1MF 100V MYLAR	
	C852	QCE22HP-103	0.01MF 500V CERAMIC	C
	C852	QCE22HP-103	0.01MF 500V CERAMIC	D
	C852	QCE22HP-103	0.01MF 500V CERAMIC	E
	C852	QCE22HP-103	0.01MF 500V CERAMIC	F
	C852	QCE22HP-103	0.01MF 500V CERAMIC	G
	C852	QFN82CK-104	0.1MF 160V MYLAR	I
	C853	QFN82AK-103	0.01MF 100V MYLAR	
	C855	EET3503-478E	4700MF ELECTRO	
	C856	EET3505-338E	3300MF ELECTRO	
	C857	QCF21HP-472	4700PF 50V CERAMIC	

▲ DISASSEMBLY PARTS

Capacitors

Δ	ITEM	PART NUMBER	DESCRIPTION			AREA
	C858	QETB1CM-107	100MF	16V	ELECTRO	
	C859	QCF21HP-472	4700PF	50V	CERAMIC	
	C860	QETB1EM-107	100MF	25V	ELECTRO	
	C861	QCF21HP-472	4700PF	50V	CERAMIC	
	C862	QETB1EM-107	100MF	25V	ELECTRO	
	C863	QCF21HP-472	4700PF	50V	CERAMIC	
	C864	QETB1EM-107	100MF	25V	ELECTRO	
	C865	QCF21HP-472	4700PF	50V	CERAMIC	
	C866	QETB1EM-107	100MF	25V	ELECTRO	
	C901	QCF21HP-223	0.022MF	50V	CERAMIC	
	C902	QCF21HP-223	0.022MF	50V	CERAMIC	
	C903	QETB1HM-226	22MF	50V	ELECTRO	
	C904	QCF21HP-103	0.01MF	50V	CERAMIC	
	C905	QCY21HK-102	1000PF	50V	CERAMIC	
	C906	QETB1AM-476	47MF	10V	ELECTRO	
	C909	QETB1CM-226	22MF	16V	ELECTRO	
	C911	QETB1HM-225	2.2MF	50V	ELECTRO	
	C941	QFLB1HK-103	0.01MF	50V	MYLAR	I
	C942	QFLB1HK-103	0.01MF	50V	MYLAR	I
	C943	QFLB1HK-103	0.01MF	50V	MYLAR	I
	C944	QFLB1HK-103	0.01MF	50V	MYLAR	I
	C945	QCY21HK-102	1000PF	50V	CERAMIC	I
	C946	QCY21HK-102	1000PF	50V	CERAMIC	I
	C947	QCY21HK-102	1000PF	50V	CERAMIC	I
	C948	QCY21HK-102	1000PF	50V	CERAMIC	I
	C949	QCS21HJ-561	560PF	50V	CERAMIC	I
	C950	QCS21HJ-561	560PF	50V	CERAMIC	I
	C951	QCS21HJ-561	560PF	50V	CERAMIC	I
	C952	QCS21HJ-561	560PF	50V	CERAMIC	I
	C971	QCS21HJ-331	330PF	50V	CERAMIC	I
	C972	QCS21HJ-331	330PF	50V	CERAMIC	I
	C973	QCF21HP-103	0.01MF	50V	CERAMIC	I
	C975	QCS21HJ-331	330PF	50V	CERAMIC	I
	C976	QCS21HJ-331	330PF	50V	CERAMIC	I
	C981	QCY21HK-102	1000PF	50V	CERAMIC	I
	C982	QETB1AM-107	100MF	10V	ELECTRO	
	C983	QETB1CM-226	22MF	16V	ELECTRO	
	C984	QETB1HM-225	2.2MF	50V	ELECTRO	
	C991	QCY21HK-222	2200PF	50V	CERAMIC	I
	C992	QCY21HK-222	2200PF	50V	CERAMIC	I
	C994	QCF21HP-472	4700PF	50V	CERAMIC	I
	C997	QCS21HJ-331	330PF	50V	CERAMIC	I
	C998	QCS21HJ-331	330PF	50V	CERAMIC	I
	C999	QCS21HJ-331	330PF	50V	CERAMIC	I

Δ DISAPPEAR PARTS

Resistors

Δ	ITEM	PART NUMBER	DESCRIPTION			AREA
	R043	QRD167J-222	2.2K	1/6W	CARBON	
	R044	QRD167J-270	27	1/6W	CARBON	C
	R044	QRD167J-270	27	1/6W	CARBON	D
	R044	QRD167J-180	18	1/6W	CARBON	E
	R044	QRD167J-180	18	1/6W	CARBON	F
	R044	QRD167J-180	18	1/6W	CARBON	G
	R044	QRD167J-180	18	1/6W	CARBON	I
	R045	QRD167J-270	27	1/6W	CARBON	C
	R045	QRD167J-270	27	1/6W	CARBON	D
	R045	QRD167J-180	18	1/6W	CARBON	E
	R045	QRD167J-180	18	1/6W	CARBON	F
	R045	QRD167J-180	18	1/6W	CARBON	G
	R045	QRD167J-180	18	1/6W	CARBON	I
	R051	QRD167J-222	2.2K	1/6W	CARBON	
	R052	QRD167J-222	2.2K	1/6W	CARBON	
	R053	QRD167J-104	100K	1/6W	CARBON	
	R054	QRD167J-104	100K	1/6W	CARBON	
	R055	QRD167J-104	100K	1/6W	CARBON	
	R056	QRD167J-104	100K	1/6W	CARBON	
	R057	QRD167J-272	2.7K	1/6W	CARBON	
	R058	QRD167J-272	2.7K	1/6W	CARBON	
	R059	QRD167J-104	100K	1/6W	CARBON	
	R060	QRD167J-104	100K	1/6W	CARBON	
Δ	R061	QRD14CJ-100S	10	1/4W	UNF. CARBON	
Δ	R062	QRD14CJ-100S	10	1/4W	UNF. CARBON	
	R063	QRD167J-100	10	1/6W	CARBON	C
	R064	QRD167J-100	10	1/6W	CARBON	C
	R701	QRD167J-222	2.2K	1/6W	CARBON	
	R702	QRD167J-222	2.2K	1/6W	CARBON	
	R703	QRD167J-104	100K	1/6W	CARBON	
	R704	QRD167J-104	100K	1/6W	CARBON	
	R705	QRD167J-202	2K	1/6W	CARBON	
	R706	QRD167J-202	2K	1/6W	CARBON	
	R707	QRD167J-202	2K	1/6W	CARBON	
	R708	QRD167J-202	2K	1/6W	CARBON	
	R709	QRD167J-822	8.2K	1/6W	CARBON	
	R710	QRD167J-822	8.2K	1/6W	CARBON	
	R711	QRD167J-152	1.5K	1/6W	CARBON	
	R712	QRD167J-152	1.5K	1/6W	CARBON	
	R713	QRD167J-104	100K	1/6W	CARBON	
	R714	QRD167J-104	100K	1/6W	CARBON	
	R715	QRD167J-101	100	1/6W	CARBON	
	R716	QRD167J-101	100	1/6W	CARBON	
Δ	R717	QRD125J-153	15K	1/2W	UNF. CARBON	
Δ	R718	QRD125J-153	15K	1/2W	UNF. CARBON	
	R719	QRD167J-391	390	1/6W	CARBON	
	R720	QRD167J-391	390	1/6W	CARBON	
Δ	R721	QRD14CJ-151S	150	1/4W	UNF. CARBON	
Δ	R722	QRD14CJ-151S	150	1/4W	UNF. CARBON	
	R723	QRD167J-152	1.5K	1/6W	CARBON	
	R724	QRD167J-152	1.5K	1/6W	CARBON	
	R725	QRD167J-333	33K	1/6W	CARBON	
	R726	QRD167J-333	33K	1/6W	CARBON	
	R727	QRD167J-391	390	1/6W	CARBON	
	R728	QRD167J-391	390	1/6W	CARBON	
	R729	QRD167J-152	1.5K	1/6W	CARBON	
	R730	QRD167J-152	1.5K	1/6W	CARBON	
Δ	R732	QRG022J-562A	5.6K	2W	O.M.FILM	
Δ	R733	QRD14CJ-680S	68	1/4W	UNF. CARBON	
Δ	R734	QRD14CJ-680S	68	1/4W	UNF. CARBON	
	R739	QRD167J-271	270	1/6W	CARBON	
	R740	QRD167J-271	270	1/6W	CARBON	
	R741	QRD167J-271	270	1/6W	CARBON	
	R742	QRD167J-271	270	1/6W	CARBON	
	R743	QRD167J-221	220	1/6W	CARBON	
	R744	QRD167J-221	220	1/6W	CARBON	
	R745	QRD167J-221	220	1/6W	CARBON	
	R746	QRD167J-221	220	1/6W	CARBON	
	R747	ERT-D2WFL351S	350	1/4W	THERMISTOR	
	R748	ERT-D2WFL351S	350	1/4W	THERMISTOR	
	R749	ERT-D2WFL351S	350	1/4W	THERMISTOR	
	R750	ERT-D2WFL351S	350	1/4W	THERMISTOR	
	R751	QRD167J-511	510	1/6W	CARBON	
	R752	QRD167J-511	510	1/6W	CARBON	
	R753	QRD167J-511	510	1/6W	CARBON	
	R754	QRD167J-511	510	1/6W	CARBON	
	R755	QRD167J-471	470	1/6W	CARBON	
	R756	QRD167J-471	470	1/6W	CARBON	
	R757	QRD167J-101	100	1/6W	CARBON	
	R758	QRD167J-101	100	1/6W	CARBON	
	R759	ERT-D2WFL351S	350	1/4W	THERMISTOR	
	R760	ERT-D2WFL351S	350	1/4W	THERMISTOR	
	R761	QRD167J-391	390	1/6W	CARBON	
	R762	QRD167J-391	390	1/6W	CARBON	
	R763	SDT250			NEGATIVE	E
	R763	SDT250			NEGATIVE	F
	R763	SDT250			NEGATIVE	G
	R763	SDT250			NEGATIVE	I
	R764	SDT250			NEGATIVE	E
	R764	SDT250			NEGATIVE	F

Δ DISAPPEAR PARTS

Resistors

Δ	ITEM	PART NUMBER	DESCRIPTION			AREA
Δ	R001	QRC128K-275EM	2.7M	1/2W	COMPOSI	C
Δ	R001	QRC128K-275EM	2.7M	1/2W	COMPOSI	D
	R011	QRD167J-222	2.2K	1/6W	CARBON	
	R012	QRD167J-104	100K	1/6W	CARBON	
	R013	QRD167J-113	11K	1/6W	CARBON	
	R014	QRD167J-202	2K	1/6W	CARBON	
	R015	QRD167J-104	100K	1/6W	CARBON	
Δ	R016	QRD14CJ-181S	180	1/4W	UNF. CARBON	
	R017	QRD167J-272	2.7K	1/6W	CARBON	
	R018	QRD167J-272	2.7K	1/6W	CARBON	
	R019	QRD167J-123	12K	1/6W	CARBON	
	R020	QRD167J-123	12K	1/6W	CARBON	
	R021	QRD167J-122	1.2K	1/6W	CARBON	
	R022	QRD167J-681	680	1/6W	CARBON	
Δ	R023	QRD14CJ-100S	10	1/4W	UNF. CARBON	
Δ	R024	QRD14CJ-100S	10	1/4W	UNF. CARBON	
Δ	R025	QRD14CJ-561S	560	1/4W	UNF. CARBON	
Δ	R026	QRD14CJ-100S	10	1/4W	UNF. CARBON	
Δ	R027	QRD14CJ-100S	10	1/4W	UNF. CARBON	
Δ	R028	ERF032K-R22	0.22	3W	CEMENT	
	R030	QRD167J-183	18K	1/6W	CARBON	
	R031	QRD167J-123	12K	1/6W	CARBON	
Δ	R032	QRD125J-330	33	1/2W	UNF. CARBON	
Δ	R033	QRG022J-100A	10	2W	O.M.FILM	
	R034	QRD167J-104	100K	1/6W	CARBON	
	R038	QRD167J-152	1.5K	1/6W	CARBON	
Δ	R039	QRD14CJ-390S	39	1/4W	UNF. CARBON	C
Δ	R039	QRD14CJ-390S	39	1/4W	UNF. CARBON	D
Δ	R039	QRD14CJ-820S	82	1/4W	UNF. CARBON	E
Δ	R039	QRD14CJ-820S	82	1/4W	UNF. CARBON	F
Δ	R039	QRD14CJ-820S	82	1/4W	UNF. CARBON	G
Δ	R039	QRD14CJ-820S	82	1/4W	UNF. CARBON	I
Δ	R040	QRG022J-391A	390	2W	O.M.FILM	C
Δ	R040	QRG022J-391A	390	2W	O.M.FILM	D
Δ	R040	QRG022J-331A	330	2W	O.M.FILM	E
Δ	R040	QRG022J-331A	330	2W	O.M.FILM	F
Δ	R040	QRG022J-331A	330	2W	O.M.FILM	G
Δ	R040	QRG022J-331A	330	2W	O.M.FILM	I
Δ	R041	QRG022J-331A	330	2W	O.M.FILM	
Δ	R042	GVPA601-501A	500		VARIABLE	

Δ DISAPPEAR PARTS

Resistors

Δ	ITEM	PART NUMBER	DESCRIPTION		AREA
	R764	SDT250		NEGATIVE	G
	R764	SDT250		NEGATIVE	I
Δ	R765	QRD14CJ-272S	2.7K	1/4W UNF. CARBON	
Δ	R766	QRD14CJ-272S	2.7K	1/4W UNF. CARBON	
Δ	R767	QRD14CJ-271S	270	1/4W UNF. CARBON	
Δ	R768	QRD14CJ-271S	270	1/4W UNF. CARBON	
Δ	R769	QRD14CJ-100S	10	1/4W UNF. CARBON	
Δ	R770	QRD14CJ-100S	10	1/4W UNF. CARBON	
Δ	R771	QRD14CJ-100S	10	1/4W UNF. CARBON	
Δ	R772	QRD14CJ-100S	10	1/4W UNF. CARBON	
Δ	R773	ERF032K-R22	0.22	3W CEMENT	
Δ	R774	ERF032K-R22	0.22	3W CEMENT	
Δ	R775	QRD125J-470	47	1/2W UNF. CARBON	
Δ	R776	QRD125J-470	47	1/2W UNF. CARBON	
Δ	R777	QRG022J-100A	10	2W O.M. FILM	
Δ	R778	QRG022J-100A	10	2W O.M. FILM	
Δ	R779	QRD14CJ-100S	10	1/4W UNF. CARBON	
Δ	R780	QRD14CJ-100S	10	1/4W UNF. CARBON	
Δ	R781	QRD14CJ-100S	10	1/4W UNF. CARBON	
Δ	R782	QRD14CJ-100S	10	1/4W UNF. CARBON	
	R783	QRD14CJ-562SX	5.6K	1/4W UNF. CARBON	C
	R783	QRD14CJ-562SX	5.6K	1/4W UNF. CARBON	D
Δ	R783	QRD14CJ-272S	2.7K	1/4W UNF. CARBON	E
Δ	R783	QRD14CJ-272S	2.7K	1/4W UNF. CARBON	F
Δ	R783	QRD14CJ-272S	2.7K	1/4W UNF. CARBON	G
Δ	R783	QRD14CJ-272S	2.7K	1/4W UNF. CARBON	I
	R801	QRD167J-104	100K	1/6W CARBON	
	R802	QRD167J-104	100K	1/6W CARBON	
Δ	R811	QRG022J-100A	10	2W O.M. FILM	
Δ	R812	QRG022J-181A	180	2W O.M. FILM	
Δ	R813	QRG022J-181A	180	2W O.M. FILM	
Δ	R814	QRD125J-272	2.7K	1/2W UNF. CARBON	
Δ	R816	QRD167J-220	22	1/6W CARBON	
Δ	R817	QRD167J-220	22	1/6W CARBON	
Δ	R818	QRD14CJ-150S	15	1/4W UNF. CARBON	C
Δ	R818	QRD14CJ-150S	15	1/4W UNF. CARBON	D
Δ	R818	QRD14CJ-150S	15	1/4W UNF. CARBON	E
Δ	R818	QRZ0077-150	15	1/4W FUSIBLE	F
Δ	R818	QRZ0077-150	15	1/4W FUSIBLE	G
Δ	R818	QRZ0077-150	15	1/4W FUSIBLE	I
Δ	R819	QRX022J-R47A	0.47	2W M. FILM	
Δ	R820	QRX022J-R47A	0.47	2W M. FILM	
Δ	R831	QRD14CJ-100S	10	1/4W UNF. CARBON	C
Δ	R831	QRD14CJ-100S	10	1/4W UNF. CARBON	D
Δ	R831	QRD14CJ-3R3S	3.3	1/4W UNF. CARBON	E
Δ	R831	QRD14CJ-3R3S	3.3	1/4W UNF. CARBON	F
Δ	R831	QRZ0077-270	27	1/4W FUSIBLE	G
Δ	R831	QRZ0077-270	27	1/4W FUSIBLE	I
Δ	R833	QRD167J-821	820	1/6W CARBON	C
Δ	R833	QRD167J-821	820	1/6W CARBON	D
Δ	R833	QRD167J-821	820	1/6W CARBON	E
Δ	R833	QRD167J-182	1.8K	1/6W CARBON	F
Δ	R833	QRD167J-182	1.8K	1/6W CARBON	G
Δ	R833	QRD167J-152	1.5K	1/6W CARBON	I
Δ	R834	QRD125J-272	2.7K	1/2W UNF. CARBON	E
Δ	R851	QRD14CJ-100S	10	1/4W UNF. CARBON	C
Δ	R851	QRD14CJ-100S	10	1/4W UNF. CARBON	D
Δ	R851	QRD14CJ-100S	10	1/4W UNF. CARBON	E
Δ	R851	QRZ0077-100	10	1/4W FUSIBLE	F
Δ	R851	QRZ0077-100	10	1/4W FUSIBLE	G
Δ	R851	QRZ0077-100	10	1/4W FUSIBLE	I
Δ	R852	QRD14CJ-821S	820	1/4W UNF. CARBON	C
Δ	R853	QRD14CJ-332S	3.3K	1/4W UNF. CARBON	D
Δ	R854	QRD14CJ-150S	15	1/4W UNF. CARBON	E
Δ	R855	QRD14CJ-101S	100	1/4W UNF. CARBON	C
Δ	R855	QRD14CJ-101S	100	1/4W UNF. CARBON	D
Δ	R855	QRD14CJ-101S	100	1/4W UNF. CARBON	E
Δ	R855	QRZ0077-101	100	1/4W FUSIBLE	F
Δ	R855	QRZ0077-101	100	1/4W FUSIBLE	G
Δ	R855	QRZ0077-101	100	1/4W FUSIBLE	I
Δ	R856	QRD167J-392	3.9K	1/6W CARBON	C
Δ	R857	QRG012J-120A	12	1W O.M. FILM	D
Δ	R858	QRD14CJ-122S	1.2K	1/4W UNF. CARBON	E
Δ	R859	QRD14CJ-100S	10	1/4W UNF. CARBON	C
Δ	R859	QRD14CJ-100S	10	1/4W UNF. CARBON	D
Δ	R859	QRD14CJ-100S	10	1/4W UNF. CARBON	E
Δ	R859	QRZ0077-100	10	1/4W FUSIBLE	F
Δ	R859	QRZ0077-100	10	1/4W FUSIBLE	G
Δ	R859	QRZ0077-100	10	1/4W FUSIBLE	I
Δ	R860	QRD14CJ-272S	2.7K	1/4W UNF. CARBON	C
Δ	R861	QRD14CJ-100S	10	1/4W UNF. CARBON	D
Δ	R861	QRD14CJ-100S	10	1/4W UNF. CARBON	E
Δ	R861	QRD14CJ-100S	10	1/4W UNF. CARBON	F
Δ	R861	QRZ0077-100	10	1/4W FUSIBLE	G
Δ	R861	QRZ0077-100	10	1/4W FUSIBLE	I
Δ	R861	QRZ0077-100	10	1/4W FUSIBLE	I
Δ	R862	QRD14CJ-122S	1.2K	1/4W UNF. CARBON	C
Δ	R863	QRD167J-272	2.7K	1/6W CARBON	D
	R901	QRD167J-102	1K	1/6W CARBON	
	R902	QRD167J-102	1K	1/6W CARBON	

Δ ISIAIRITY PARTS

Resistors

Δ	ITEM	PART NUMBER	DESCRIPTION			AREA
	R903	QRD167J-562	5.6K	1/6W CARBON		
	R904	QRD167J-562	5.6K	1/6W CARBON		
	R905	QRD167J-123	12K	1/6W CARBON		
	R906	QRD167J-123	12K	1/6W CARBON		
	R907	QRD167J-102	1K	1/6W CARBON		
	R908	QRD167J-102	1K	1/6W CARBON		
	R909	QRD167J-103	10K	1/6W CARBON		
	R911	QRD167J-332	3.3K	1/6W CARBON		
	R912	QRD167J-473	47K	1/6W CARBON		
	R913	QRD167J-104	100K	1/6W CARBON		
	R914	QRD167J-823	82K	1/6W CARBON		
	R915	QRD167J-823	82K	1/6W CARBON		
	R916	QRD167J-563	56K	1/6W CARBON		
	R917	QRD167J-683	68K	1/6W CARBON		
	R918	QRD167J-392	3.9K	1/6W CARBON		
	R921	QRD167J-224	220K	1/6W CARBON		
	R922	QRD167J-562	5.6K	1/6W CARBON		
Δ	R924	QRG022J-122A	1.2K	2W O.M. FILM	C	
Δ	R924	QRG022J-122A	1.2K	2W O.M. FILM	D	
Δ	R924	QRG022J-182A	1.8K	2W O.M. FILM	E	
Δ	R924	QRG022J-182A	1.8K	2W O.M. FILM	F	
Δ	R924	QRG022J-182A	1.8K	2W O.M. FILM	G	
Δ	R924	QRG022J-182A	1.8K	2W O.M. FILM	I	
	R925	QRD167J-181	180	1/6W CARBON	C	
	R925	QRD167J-181	180	1/6W CARBON	D	
	R925	QRD167J-151	150	1/6W CARBON	E	
	R925	QRD167J-151	150	1/6W CARBON	F	
	R925	QRD167J-151	150	1/6W CARBON	G	
	R925	QRD167J-151	150	1/6W CARBON	I	
	R926	QRD167J-181	180	1/6W CARBON	C	
	R926	QRD167J-181	180	1/6W CARBON	D	
	R926	QRD167J-151	150	1/6W CARBON	E	
	R926	QRD167J-151	150	1/6W CARBON	F	
	R926	QRD167J-151	150	1/6W CARBON	G	
	R926	QRD167J-151	150	1/6W CARBON	I	
	R927	QRD167J-181	180	1/6W CARBON	C	
	R927	QRD167J-181	180	1/6W CARBON	D	
	R927	QRD167J-151	150	1/6W CARBON	E	
	R927	QRD167J-151	150	1/6W CARBON	F	
	R927	QRD167J-151	150	1/6W CARBON	G	
	R927	QRD167J-151	150	1/6W CARBON	I	
	R928	QRD167J-151	150	1/6W CARBON		
Δ	R929	QRD14CJ-470S	47	1/4W UNF. CARBON		
	R930	QRD167J-472	4.7K	1/6W CARBON	C	
	R930	QRD167J-472	4.7K	1/6W CARBON	D	
	R930	QRD167J-512	5.1K	1/6W CARBON	E	
	R930	QRD167J-472	4.7K	1/6W CARBON	F	
	R930	QRD167J-472	4.7K	1/6W CARBON	G	
	R930	QRD167J-472	4.7K	1/6W CARBON	I	
	R931	QRD167J-123	12K	1/6W CARBON		
Δ	R932	QRD167J-162	1.6K	1/6W CARBON		
Δ	R933	QRG022J-182A	1.8K	2W O.M. FILM	E	
Δ	R933	QRG022J-182A	1.8K	2W O.M. FILM	F	
Δ	R933	QRG022J-182A	1.8K	2W O.M. FILM	G	
Δ	R933	QRG022J-182A	1.8K	2W O.M. FILM	I	
Δ	R934	QRD167J-162	1.6K	1/6W CARBON		
Δ	R941	QRZ0077-100	10	1/4W FUSIBLE	I	
Δ	R942	QRZ0077-100	10	1/4W FUSIBLE	I	
Δ	R943	QRZ0077-100	10	1/4W FUSIBLE	I	
Δ	R944	QRZ0077-100	10	1/4W FUSIBLE	I	
Δ	R973	QRG022J-471A	470	2W O.M. FILM		
Δ	R974	QRG022J-471A	470	2W O.M. FILM		
	R981	QRD167J-823	82K	1/6W CARBON		
	R982	QRD167J-104	100K	1/6W CARBON		
	R983	QRD167J-563	56K	1/6W CARBON		
	R984	QRD167J-563	56K	1/6W CARBON		
	R985	QRD167J-683	68K	1/6W CARBON		
	R986	QRD167J-392	3.9K	1/6W CARBON		
	R987	QRD167J-224	220K	1/6W CARBON		
	R988	QRD167J-562	5.6K	1/6W CARBON		
Δ	R989	QRG012J-221A	220	1W O.M. FILM	C	
Δ	R989	QRG012J-221A	220	1W O.M. FILM	D	
Δ	R989	QRG012J-101A	100	1W O.M. FILM	E	
Δ	R989	QRG012J-101A	100	1W O.M. FILM	F	
Δ	R989	QRG012J-101A	100	1W O.M. FILM	G	
Δ	R989	QRG012J-101A	100	1W O.M. FILM	I	
	R990	QRD167J-682	6.8K	1/6W CARBON	C	
	R990	QRD167J-682	6.8K	1/6W CARBON	D	
	R990	QRD167J-822	8.2K	1/6W CARBON	E	
	R990	QRD167J-682	6.8K	1/6W CARBON	F	
	R990	QRD167J-682	6.8K	1/6W CARBON	G	
	R990	QRD167J-682	6.8K	1/6W CARBON	I	
	R991	QRD167J-682	6.8K	1/6W CARBON		
	R998	QRD167J-220	22	1/6W CARBON	C	
	R998	QRD167J-220	22	1/6W CARBON	D	
Δ	R999	QRG022J-101A	100	2W O.M. FILM	E	
Δ	R999	QRG022J-101A	100	2W O.M. FILM	F	
Δ	R999	QRG022J-101A	100	2W O.M. FILM	G	
Δ	R999	QRG022J-101A	100	2W O.M. FILM	I	
Δ	VR701	QVPA601-501A	500	VARIABLE		
Δ	VR702	QVPA601-501A	500	VARIABLE		

Δ ISIAIRITY PARTS

Others

Δ	ITEM	PART NUMBER	DESCRIPTION	AREA
		EMW10083-002	CIRCUIT BOARD	
		E305265-002SM	HEAT SINK BRACKET	
		E305266-002SM	HEAT SINK BRACKET	
		E70859-001	EARTH PLATE	
		E70945-H25	HEAT SINK	
		E73525-003	SCREW	
		E75137-001SM	SUB HEAT SINK	
		SBSG3008CC	SCREW	
		SBSG3008M	SCREW	
		E300209-044	HEAT SINK	C
		E300209-044	HEAT SINK	D
		E300209-044	HEAT SINK	E
		E70945-H40B	HEAT SINK	E
		SBSB3008CC	SCREW	E
		E306101-003	HEAT SINK	F
		E67132-T2R5	FUSE LABEL	F
		E306101-003	HEAT SINK	G
		E67132-T2R5	FUSE LABEL	G
		E306101-003	HEAT SINK	I
		E67132-T2R5	FUSE LABEL	I
		E70225-001	EARTH PLATE	I
	001	E65508-002	TAB	
	F001	VMZ0087-001	FUSE CLIP	C
	F001	VMZ0087-001	FUSE CLIP	D
	F001	VMZ0087-001	FUSE CLIP	F
	F001	VMZ0087-001	FUSE CLIP	G
	F001	VMZ0087-001	FUSE CLIP	I
	F002	VMZ0087-001	FUSE CLIP	F
	F002	VMZ0087-001	FUSE CLIP	G
	F002	VMZ0087-001	FUSE CLIP	I
	F851	VMZ0087-001	FUSE CLIP	
	F852	VMZ0087-001	FUSE CLIP	
Δ	J010	QMC0440-001	AC OUTLET	C
Δ	J010	QMC0440-001	AC OUTLET	D
Δ	J010	QMC0437-002	AC OUTLET	E
	J701	EMB90TV-801A	SPEAKER TERMINAL	
	J702	EMB90TV-401A	SPEAKER TERMINAL	
	J703	EMB90YV-201AG	ANTENNA TERMINAL	
	J901	QMS6A40-021	HEADPHONE JACK	
	K021	ENZ8101-007	INDUCTOR	I
	K821	ENZ8101-007	INDUCTOR	I
	L011	EQL0001-R45	INDUCTOR	
	L023	EQL0001-R45	INDUCTOR	I
	L051	EQL0001-R45	INDUCTOR	C
	L051	EQL0001-R45	INDUCTOR	I
	L052	EQL0001-R45	INDUCTOR	C
	L052	EQL0001-R45	INDUCTOR	I
	L701	EQL0101-1R2	INDUCTOR	
	L702	EQL0101-1R2	INDUCTOR	
	P307	EMV5109-003A	PLUG ASSY (3PIN)	
	P803	VMC0107-004	CONNECT TERMINAL (4PIN)	
	P804	VMC0107-007	CONNECT TERMINAL (7PIN)	
	P851	VMC0107-006	CONNECT TERMINAL (6PIN)	
	P904	VMC0107-003	CONNECT TERMINAL (3PIN)	
	S901	QST4231-E01J2	PUSH SWITCH (SPK-1)	
	S902	QST4231-E01J2	PUSH SWITCH (SPK-2)	
Δ	T002	ETP1000-41JA	POWER TRANSFORMER	C
Δ	T002	ETP1000-41JA	POWER TRANSFORMER	D
Δ	T002	ETP1000-41ZB	POWER TRANSFORMER	E
Δ	T002	ETP1000-41EA	POWER TRANSFORMER	F
Δ	T002	ETP1000-41EA	POWER TRANSFORMER	G
Δ	T002	ETP1000-41EA	POWER TRANSFORMER	I
	EP001	E70859-001	EARTH PLATE	
	FW308	EWS293-0120	SOCKET WIRE (3PIN)	
	FW309	EWS293-0125	SOCKET WIRE (3PIN)	
	FW802	EWS267-A422	SOCKET WIRE (7PIN)	
	FW804	EWR37B-35LST	FLAT WIRE (7PIN)	
	FW851	EWR36B-20LST	FLAT WIRE (6PIN)	
	FW852	EWR34B-30LST	FLAT WIRE (4PIN)	
	FW853	EWR33B-16LST	FLAT WIRE (3PIN)	
	FW901	EWR34B-16SST	FLAT WIRE (4PIN)	
	FW902	EWR36B-40SST	FLAT WIRE (6PIN)	
	FW903	EWR33B-08SST	FLAT WIRE (3PIN)	
	FW904	EWR33B-35LST	FLAT WIRE (3PIN)	
	PA001	EMV5125-008	PLUG ASSY	
	PB001	EMV7125-008R	CONNECTOR	
	RT001	E67764-102	WRAPPING TERMINAL	
	RT002	E67764-203	WRAPPING TERMINAL	
	RT003	E67764-102	WRAPPING TERMINAL	E
	RT004	E67764-302	WRAPPING TERMINAL	E
	RT011	E67764-102	WRAPPING TERMINAL	
	RT012	E67764-202	WRAPPING TERMINAL	
	RT801	E67764-103	WRAPPING TERMINAL	
	RT802	E67764-103	WRAPPING TERMINAL	
Δ	RY001	ESK1D12-115	RELAY	C
Δ	RY001	ESK1D12-115	RELAY	D
Δ	RY001	ESK1D12-115	RELAY	E
Δ	RY001	ESK1D12-113	RELAY	F
Δ	RY001	ESK1D12-115	RELAY	G
Δ	RY001	ESK1D12-115	RELAY	I
	RY011	ESK1D12-118J1	RELAY	
	RY901	ESK7D24-2120	RELAY	
	RY981	ESK8D12-211M	RELAY	

Δ IS A SPECIALTY PARTS

Capacitors

Δ	ITEM	PART NUMBER	DESCRIPTION	AREA
	C101	QCF21HP-223	0.022MF 50V CERAMIC	
	C122	QCF21HP-223	0.022MF 50V CERAMIC	
	C126	QCF21HP-223	0.022MF 50V CERAMIC	
	C132	QCS21HJ-561	560PF 50V CERAMIC	
	C133	QCHB1EZ-223	0.022MF 25V CERAMIC	
	C134	QETB1EM-106	10MF 25V ELECTRO	
	C135	QCC21EM-223	0.022MF 25V CERAMIC	
	C136	QCT26CH-180	18PF 50V CERAMIC	
	C137	QCT26CH-221	220PF 50V CERAMIC	
	C138	QCT26CH-241	240PF 50V CERAMIC	
	C139	QCC21EM-223	0.022MF 25V CERAMIC	N
	C141	QCS21HJ-270	27PF 50V CERAMIC	N
	C142	QCY21HK-272	2700PF 50V CERAMIC	N
	C143	QCHB1EZ-223	0.022MF 25V CERAMIC	N
	C144	QETB1EM-106	10MF 25V ELECTRO	N
	C146	QCT26CH-680	68PF 50V CERAMIC	N
	C147	QCT26CH-220	22PF 50V CERAMIC	N
	C148	QCT26CH-121	120PF 50V CERAMIC	N
	C149	QCF21HP-223	0.022MF 50V CERAMIC	
	C150	QCHB1EZ-223	0.022MF 25V CERAMIC	
	C151	QCF21HP-223	0.022MF 50V CERAMIC	
	C152	QCF21HP-223	0.022MF 50V CERAMIC	
	C153	QCC21EM-223	0.022MF 25V CERAMIC	
	C154	QCF21HP-223	0.022MF 50V CERAMIC	
	C155	QETB1EM-226	22MF 25V ELECTRO	
	C156	QETB1HM-475	4.7MF 50V ELECTRO	
	C157	QETB1HM-474	0.47MF 50V ELECTRO	
	C158	QCB1HK-101	100PF 50V CERAMIC	
	C159	QCB1HK-101	100PF 50V CERAMIC	
	C160	QCB1HK-221	220PF 50V CERAMIC	
	C161	QCHB1EZ-223	0.022MF 25V CERAMIC	
	C162	QETB1EM-106	10MF 25V ELECTRO	
	C163	QFLB1HJ-332	3300PF 50V MYLAR	
	C164	QCHB1EZ-223	0.022MF 25V CERAMIC	
	C165	QETB1HM-474	0.47MF 50V ELECTRO	
	C166	QETB1HM-225	2.2MF 50V ELECTRO	
	C167	QETB1HM-225	2.2MF 50V ELECTRO	
	C168	QETB1HM-475	4.7MF 50V ELECTRO	
	C169	QCF21HP-223	0.022MF 50V CERAMIC	
	C170	QCHB1EZ-223	0.022MF 25V CERAMIC	
	C171	QETB1EM-106	10MF 25V ELECTRO	
	C172	QCVB1CM-103	0.01MF 16V CERAMIC	
	C173	QFLB1HK-223	0.022MF 50V MYLAR	
	C174	QFLB1HK-473	0.047MF 50V MYLAR	
	C175	QETB1EM-106	10MF 25V ELECTRO	
	C176	QCY21HK-102	1000PF 50V CERAMIC	H
	C177	QCS21HJ-561	560PF 50V CERAMIC	I
	C177	QCS21HJ-561	560PF 50V CERAMIC	J
	C177	QCS21HJ-271	270PF 50V CERAMIC	N
	C177	QCS21HJ-271	270PF 50V CERAMIC	N
	C178	QCS21HJ-561	560PF 50V CERAMIC	H
	C178	QCS21HJ-561	560PF 50V CERAMIC	I
	C178	QCS21HJ-271	270PF 50V CERAMIC	J
	C178	QCS21HJ-271	270PF 50V CERAMIC	N
	C179	QETB1HM-225	2.2MF 50V ELECTRO	
	C180	QETB1HM-225	2.2MF 50V ELECTRO	
	C181	QETB1EM-106	10MF 25V ELECTRO	
	C182	QETB1HM-225	2.2MF 50V ELECTRO	
	C183	QETB1HM-105	1MF 50V ELECTRO	
	C184	QETB1HM-105	1MF 50V ELECTRO	
	C185	QETB1HM-225	2.2MF 50V ELECTRO	
	C186	QETB1HM-474	0.47MF 50V ELECTRO	
	C192	QCC21EM-473	0.047MF 25V CERAMIC	
	C193	QCS21HJ-180	18PF 50V CERAMIC	
	C194	QCS21HJ-180	18PF 50V CERAMIC	
	C195	QEN51HM-474	0.47MF 50V NON POLE	
	C196	QCY21HK-102	1000PF 50V CERAMIC	
	C230	QCF21HP-103	0.01MF 50V CERAMIC	
	C240	QCB1HK-101	100PF 50V CERAMIC	N

Δ SAFETY PARTS

Resistors

Δ	ITEM	PART NUMBER	DESCRIPTION	AREA
	R117	QRD167J-100	10 1/6W CARBON	
	R118	QRD167J-332	3.3K 1/6W CARBON	
	R119	QRD167J-221	220 1/6W CARBON	
	R121	QRD167J-391	390 1/6W CARBON	
	R122	QRD167J-272	2.7K 1/6W CARBON	
	R123	QRD167J-102	1K 1/6W CARBON	
	R124	QRD167J-681	680 1/6W CARBON	
	R125	QRD167J-332	3.3K 1/6W CARBON	
	R126	QRD167J-221	220 1/6W CARBON	
	R131	QRD167J-331	330 1/6W CARBON	
	R132	QRD167J-103	10K 1/6W CARBON	
	R133	QRD167J-473	47K 1/6W CARBON	
	R134	QRD167J-103	10K 1/6W CARBON	N
	R135	QRD167J-470	47 1/6W CARBON	
	R136	QRD167J-103	10K 1/6W CARBON	

Δ SAFETY PARTS

Resistors

Δ	ITEM	PART NUMBER	DESCRIPTION	AREA
	R141	QRD167J-472	4.7K 1/6W CARBON	N
	R142	QRD167J-331	330 1/6W CARBON	N
	R143	QRD167J-103	10K 1/6W CARBON	N
	R144	QRD167J-473	47K 1/6W CARBON	N
	R145	QRD167J-103	10K 1/6W CARBON	N
	R146	QRD167J-560	56 1/6W CARBON	
	R147	QRD167J-103	10K 1/6W CARBON	
	R148	QRD167J-103	10K 1/6W CARBON	
	R149	QRD167J-223	22K 1/6W CARBON	
	R150	QRD167J-103	10K 1/6W CARBON	
	R151	QRD167J-224	220K 1/6W CARBON	
	R153	QRD167J-103	10K 1/6W CARBON	
	R154	QRD167J-103	10K 1/6W CARBON	
	R155	QRD167J-562	5.6K 1/6W CARBON	
	R156	QRD167J-822	8.2K 1/6W CARBON	
	R157	QRD167J-103	10K 1/6W CARBON	
	R158	QRD167J-183	18K 1/6W CARBON	H
	R158	QRD167J-333	33K 1/6W CARBON	I
	R158	QRD167J-333	33K 1/6W CARBON	J
	R158	QRD167J-333	33K 1/6W CARBON	N
	R159	QRD167J-561	560 1/6W CARBON	
	R160	QRD167J-123	12K 1/6W CARBON	H
	R160	QRD167J-123	12K 1/6W CARBON	I
	R160	QRD167J-273	27K 1/6W CARBON	J
	R160	QRD167J-273	27K 1/6W CARBON	N
	R161	QRD167J-124	120K 1/6W CARBON	H
	R161	QRD167J-124	120K 1/6W CARBON	I
	R161	QRD167J-184	180K 1/6W CARBON	J
	R161	QRD167J-184	180K 1/6W CARBON	N
	R162	QRD167J-124	120K 1/6W CARBON	H
	R162	QRD167J-124	120K 1/6W CARBON	I
	R162	QRD167J-184	180K 1/6W CARBON	J
	R162	QRD167J-184	180K 1/6W CARBON	N
	R163	QRD167J-332	3.3K 1/6W CARBON	
	R164	QRD167J-332	3.3K 1/6W CARBON	
	R165	QRD167J-184	180K 1/6W CARBON	H
	R165	QRD167J-184	180K 1/6W CARBON	I
	R165	QRD167J-274	270K 1/6W CARBON	J
	R165	QRD167J-274	270K 1/6W CARBON	N
	R166	QRD167J-184	180K 1/6W CARBON	H
	R166	QRD167J-184	180K 1/6W CARBON	I
	R166	QRD167J-274	270K 1/6W CARBON	J
	R166	QRD167J-274	270K 1/6W CARBON	N
	R167	QRD167J-393	39K 1/6W CARBON	H
	R167	QRD167J-393	39K 1/6W CARBON	I
	R168	QRD167J-103	10K 1/6W CARBON	
	R169	QRD167J-103	10K 1/6W CARBON	
	R171	QRD167J-682	6.8K 1/6W CARBON	
	R172	QRD167J-682	6.8K 1/6W CARBON	
	R179	QRD167J-562	5.6K 1/6W CARBON	
	R180	QRD167J-472	4.7K 1/6W CARBON	
	R181	QRD167J-222	2.2K 1/6W CARBON	
	R182	QRD167J-181	180 1/6W CARBON	
	R187	QRD167J-101	100 1/6W CARBON	
	R190	QRD167J-472	4.7K 1/6W CARBON	
	R194	QRD167J-472	4.7K 1/6W CARBON	
	R195	QRD167J-473	47K 1/6W CARBON	
	R196	QRD167J-103	10K 1/6W CARBON	H
	R196	QRD167J-103	10K 1/6W CARBON	I
	R196	QRD167J-103	10K 1/6W CARBON	J
	R196	QRD167J-222	2.2K 1/6W CARBON	N
	R197	QRD167J-222	2.2K 1/6W CARBON	
	R198	QRD167J-332	3.3K 1/6W CARBON	H
	R198	QRD167J-332	3.3K 1/6W CARBON	I
	R198	QRD167J-332	3.3K 1/6W CARBON	J
	R198	QRD167J-822	8.2K 1/6W CARBON	N
	R199	QRD167J-472	4.7K 1/6W CARBON	
	R201	QRD145J-680S	68 1/4W UNF. CARBON	H
	R201	QRZ0062-680	68 1/4W FUSIBLE	I
	R201	QRZ0062-680	68 1/4W FUSIBLE	J
	R201	QRZ0062-680	68 1/4W FUSIBLE	N
	R202	QRD145J-470S	47 1/4W UNF. CARBON	H
	R202	QRZ0062-470	47 1/4W FUSIBLE	I
	R202	QRZ0062-470	47 1/4W FUSIBLE	J
	R202	QRZ0062-220	22 1/4W FUSIBLE	N
	VR167	QVPE601-104	100K 0.15W VARIABLE	J
	VR167	QVPE601-104	100K 0.15W VARIABLE	N

Δ SAFETY PARTS

Others

Δ	ITEM	PART NUMBER	DESCRIPTION	AREA
	J102	E11849-502(S)	CIRCUIT BOARD	
	L101	QMS3501-021	MINI JACK (COMPULINK)	
	L106	EQL4004-1R0	INDUCTOR	
	P101	EQL3001-102K	INDUCTOR	
	P101	EMV7112-008	CONNECTOR (8PIN)	

Δ SAFETY PARTS

Others

Δ	ITEM	PART NUMBER	DESCRIPTION	AREA
	P103	EMV7112-006	CONNECTOR (6PIN)	
	P105	EMV7112-003	CONNECTOR (3PIN)	I
	T101	EQR1111-014	AM RF COIL	
	T102	EQR1111-005	AM RF COIL	N
	T103	EQR1207-015	MW OSC COIL	
	T104	EQR1307-009	LW OSC COIL	N
	T105	EQT2140-012	I.F. TRANSFORMER	
	T106	EQT2140-013	I.F. TRANSFORMER	
	T107	ECB1560-006	CERAMIC FILTER	
	AT101	EMB41YV-401K	ANTENNA TERMINAL	H
	AT101	EMB41YV-401K	ANTENNA TERMINAL	I
	AT101	EMB41YV-401K	ANTENNA TERMINAL	J
	AT101	EMB41YV-301K	ANTENNA TERMINAL	N
	CF101	ECB2123-006R	CERAMIC FILTER	H
	CF101	ECB2123-006R	CERAMIC FILTER	I
	CF101	ECB2118-007R	CERAMIC FILTER	J
	CF101	ECB2118-007R	CERAMIC FILTER	N
	CF102	ECB2123-006R	CERAMIC FILTER	H
	CF102	ECB2123-006R	CERAMIC FILTER	I
	CF102	ECB2118-007R	CERAMIC FILTER	J
	CF102	ECB2118-007R	CERAMIC FILTER	N
	EP101	E70859-001	EARTH PLATE	
	EP102	E70859-001	EARTH PLATE	
	EP110	E70225-001	EARTH PLATE	
	FE101	EAF2203-001	FRONT END	H
	FE101	EAF2203-001	FRONT END	I
	FE101	EAF2203-001	FRONT END	J
	FE101	EAF2203-003	FRONT END	N
	LP101	EQF0101-002	LOW PASS FILTER	
	LP102	EQF0102-001	LOW PASS FILTER	N
	SW202	QSS1201-039	SLIDE SWITCH	I
	TC105	ENZ1003-006	TRIMMER	
	TC106	ENZ1003-006	TRIMMER	N
	XT102	ECX0007-200KC	RESONATOR	
	XT103	ECX0000-456KR	RESONATOR	

Δ : ISAFETY PARTS

■ ENC-082 □ Source Selector & Surround PC Board Ass'y

Note : ENC-082 □ varies according to the areas employed. See note (1) when placing an order.

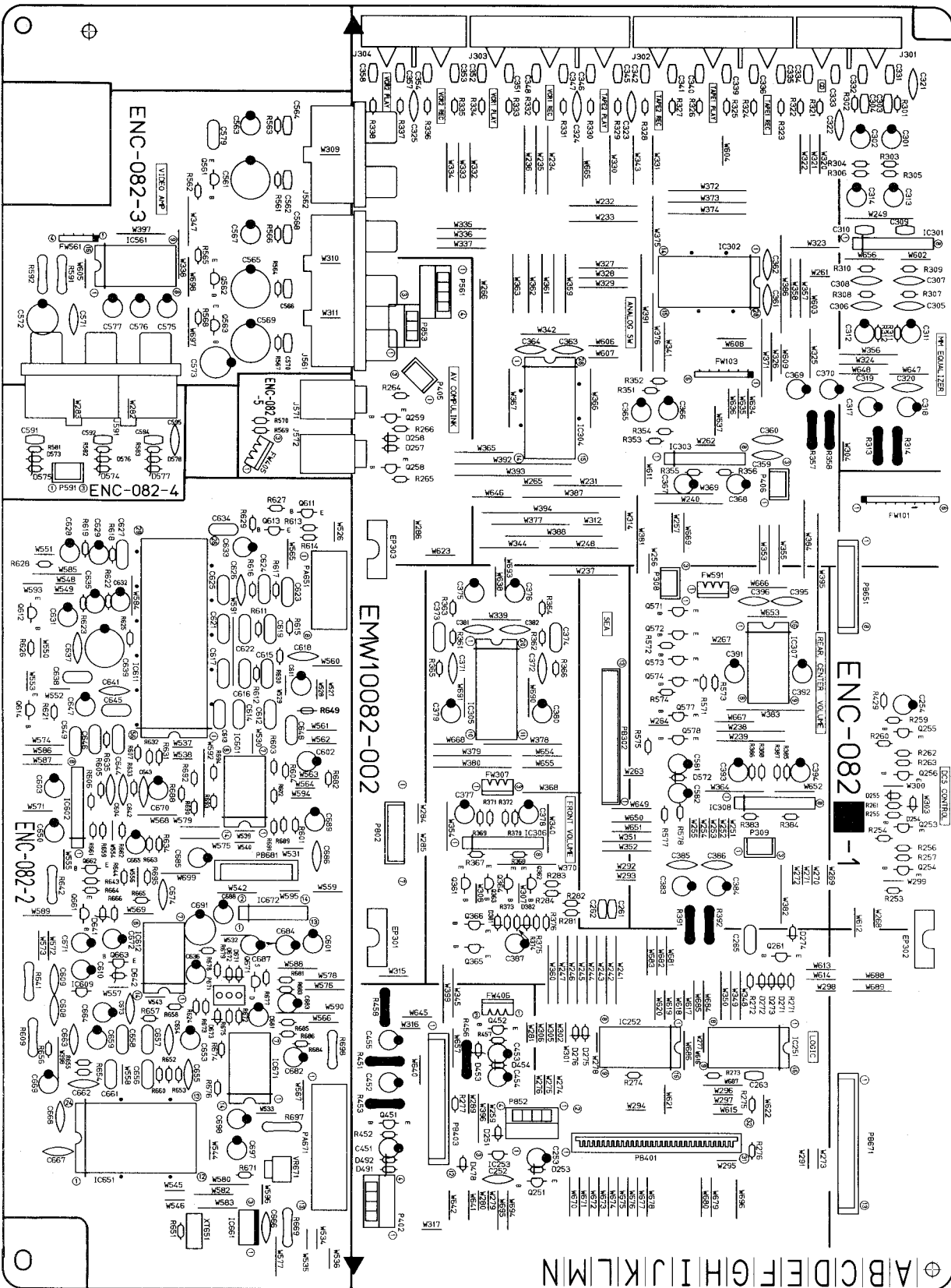

Note (1)

PC Board Ass'y	Designated Areas
ENC-082 C	the U.S.A.
ENC-082 D	Canada
ENC-082 E	Universal Type
ENC-082 F	Australia Continental Europe (with LW)
ENC-082 H	Germany (with LW)

Transistors

ITEM	PART NUMBER	DESCRIPTION	AREA
Q251	DTC114YS	SILICON ROHM	
Q253	2SC458(C,D)	SILICON HITACHI	
Q254	2SC458(C,D)	SILICON HITACHI	
Q255	2SC458(C,D)	SILICON HITACHI	
Q256	2SC458(C,D)	SILICON HITACHI	
Q258	AA1L4M	SILICON NEC	
Q259	DTC114YS	SILICON ROHM	
Q261	AA1L4M	SILICON NEC	
Q361	2SK301(P,Q)	F.E.T MATSUSHITA	
Q362	2SK301(P,Q)	F.E.T MATSUSHITA	
Q365	DTA114YS	SILICON ROHM	
Q366	AA1L4M	SILICON NEC	
Q451	2SC2235(O,Y)	SILICON TOSHIBA	
Q452	2SA965(O,Y)	SILICON TOSHIBA	
Q561	2SA933S(R,S)	SILICON ROHM	
Q562	2SA933S(R,S)	SILICON ROHM	
Q563	2SA933S(R,S)	SILICON ROHM	
Q571	2SK301(P,Q)	F.E.T MATSUSHITA	
Q572	2SK301(P,Q)	F.E.T MATSUSHITA	
Q577	AA1L4M	SILICON NEC	
Q578	DTA114YS	SILICON ROHM	
Q611	2SD655(D,E)	SILICON HITACHI	
Q612	AA1L4M	SILICON NEC	
Q613	2SD655(D,E)	SILICON HITACHI	
Q614	AA1L4M	SILICON NEC	
Q661	AA1L4M	SILICON NEC	
Q662	AA1L4M	SILICON NEC	
Q663	AA1L4M	SILICON NEC	
Q671	2SK163(L1)	F.E.T NEC	

I.C.s

ITEM	PART NUMBER	DESCRIPTION	AREA
IC251	TC74HC595AP	I.C. TOSHIBA	
IC252	TC74HC595AP	I.C. TOSHIBA	
IC253	MN1281(P,Q)	I.C. MATSUSHITA	
IC301	VC4580LD	I.C. DAINICHI	
IC302	TC9164N	I.C. TOSHIBA	
IC303	VC4580L	I.C. DAINICHI	
IC304	TC9163N	I.C. TOSHIBA	
IC305	TC9177P	I.C. TOSHIBA	
IC306	VC4580L	I.C. DAINICHI	
IC307	TC9176P	I.C. TOSHIBA	
IC308	VC4580L	I.C. DAINICHI	
IC561	BA7625	I.C. ROHM	
IC601	NJM084D	I.C. DAINICHI	
IC602	VC4580L	I.C. DAINICHI	
IC609	RC78L12	I.C.	
IC611	NJM2175L	I.C. DAINICHI	
IC612	TC4066BP	I.C. TOSHIBA	
IC651	M50198P	I.C. MITSUBISHI	
IC661	NJM78M05FD	I.C. DAINICHI	
IC671	UPC324C	I.C. NEC	
IC672	M51523AL	I.C. MITSUBISHI	

Diodes

ITEM	PART NUMBER	DESCRIPTION	AREA
D251	1SS133	SILICON ROHM	
D253	1SS133	SILICON ROHM	
D254	1SS133	SILICON ROHM	
D255	1SS133	SILICON ROHM	
D257	1SS133	SILICON ROHM	
D258	1SS133	SILICON ROHM	
D271	1SS133	SILICON ROHM	
D272	1SS133	SILICON ROHM	
D273	1SS133	SILICON ROHM	
D274	1SS133	SILICON ROHM	

Diodes

ITEM	PART NUMBER	DESCRIPTION	AREA
D275	1SS133	SILICON ROHM	
D276	1SS133	SILICON ROHM	
D277	1SS133	SILICON ROHM	
D453	MTZ5.6JC	ZENER ROHM	
D454	1SS133	SILICON ROHM	
D478	1SS133	SILICON ROHM	
D491	MTZ5.6JC	ZENER ROHM	
D492	1SS133	SILICON ROHM	
D572	1SS133	SILICON ROHM	
D573	MTZ13JC	ZENER ROHM	
D574	MTZ13JC	ZENER ROHM	
D575	MTZ13JC	ZENER ROHM	
D576	MTZ13JC	ZENER ROHM	
D641	MTZ8.2JC	ZENER ROHM	
D642	MTZ8.2JC	ZENER ROHM	
D671	1SS133	SILICON ROHM	
D672	1SS133	SILICON ROHM	
D673	1SS133	SILICON ROHM	

Capacitors

ITEM	PART NUMBER	DESCRIPTION	AREA
C252	QCY21HK-102	1000PF 50V CERAMIC	
C253	QETB1HM-225	2.2MF 50V ELECTRO	
C254	QETB1HM-475	4.7MF 50V ELECTRO	
C261	QCBB1HK-561	560PF 50V CERAMIC	
C262	QCBB1HK-561	560PF 50V CERAMIC	
C263	QCBB1HK-561	560PF 50V CERAMIC	
C265	QFVB1HJ-564	0.56MF 50V T.FILM	
C266	QCS21HJ-561	560PF 50V CERAMIC	
C267	QCF21HP-103	0.01MF 50V CERAMIC	
C301	QETB1HM-475	4.7MF 50V ELECTRO	
C302	QETB1HM-475	4.7MF 50V ELECTRO	
C303	QCBB1HK-101	100PF 50V CERAMIC	
C304	QCBB1HK-101	100PF 50V CERAMIC	
C305	QCY21HK-182	1800PF 50V CERAMIC	
C306	QCY21HK-182	1800PF 50V CERAMIC	
C307	QCY21HK-682	6800PF 50V CERAMIC	
C308	QCY21HK-682	6800PF 50V CERAMIC	
C309	QCBB1HK-101	100PF 50V CERAMIC	
C310	QCBB1HK-101	100PF 50V CERAMIC	
C311	QETB1HM-475	4.7MF 50V ELECTRO	
C312	QETB1HM-475	4.7MF 50V ELECTRO	
C313	QETB1AM-476	47MF 10V ELECTRO	
C314	QETB1AM-476	47MF 10V ELECTRO	
C317	QETB1EM-476	47MF 25V ELECTRO	
C318	QETB1EM-476	47MF 25V ELECTRO	
C319	QCF21HP-103	0.01MF 50V CERAMIC	
C320	QCF21HP-103	0.01MF 50V CERAMIC	
C321	QFLB1HJ-124	0.12MF 50V MYLAR	
C322	QFLB1HJ-124	0.12MF 50V MYLAR	
C323	QFLB1HJ-124	0.12MF 50V MYLAR	
C324	QFLB1HJ-124	0.12MF 50V MYLAR	
C325	QFLB1HJ-124	0.12MF 50V MYLAR	
C331	QCBB1HK-331	330PF 50V CERAMIC	H
C332	QCBB1HK-331	330PF 50V CERAMIC	H
C333	QCBB1HK-331	330PF 50V CERAMIC	H
C334	QCBB1HK-331	330PF 50V CERAMIC	H
C335	QCBB1HK-331	330PF 50V CERAMIC	H
C336	QCBB1HK-331	330PF 50V CERAMIC	H
C339	QCBB1HK-331	330PF 50V CERAMIC	H
C340	QCBB1HK-331	330PF 50V CERAMIC	H
C341	QCBB1HK-331	330PF 50V CERAMIC	H
C342	QCBB1HK-331	330PF 50V CERAMIC	H
C345	QCBB1HK-331	330PF 50V CERAMIC	H
C346	QCBB1HK-331	330PF 50V CERAMIC	H
C347	QCBB1HK-331	330PF 50V CERAMIC	H
C348	QCBB1HK-331	330PF 50V CERAMIC	H
C351	QCBB1HK-331	330PF 50V CERAMIC	H
C352	QCBB1HK-331	330PF 50V CERAMIC	H
C353	QCBB1HK-331	330PF 50V CERAMIC	H
C354	QCBB1HK-331	330PF 50V CERAMIC	H
C357	QCBB1HK-331	330PF 50V CERAMIC	H
C358	QCBB1HK-331	330PF 50V CERAMIC	H
C359	QCF21HP-103	0.01MF 50V CERAMIC	
C360	QCF21HP-103	0.01MF 50V CERAMIC	
C361	QCF21HP-103	0.01MF 50V CERAMIC	
C362	QCF21HP-103	0.01MF 50V CERAMIC	
C363	QCF21HP-103	0.01MF 50V CERAMIC	
C364	QCF21HP-103	0.01MF 50V CERAMIC	
C365	QETB1EM-106	10MF 25V ELECTRO	
C366	QETB1EM-106	10MF 25V ELECTRO	
C367	QETB1EM-106	10MF 25V ELECTRO	
C368	QETB1EM-106	10MF 25V ELECTRO	
C369	QETB1EM-476	47MF 25V ELECTRO	
C370	QETB1EM-476	47MF 25V ELECTRO	
C371	QCS21HJ-181	180PF 50V CERAMIC	

Capacitors

△	ITEM	PART NUMBER	DESCRIPTION			AREA
	C372	QCS21HJ-181	180PF	50V	CERAMIC	
	C373	QFLB1HK-333	0.033MF	50V	MYLAR	
	C374	QFLB1HK-333	0.033MF	50V	MYLAR	
	C375	QETB1HM-225	2.2MF	50V	ELECTRO	
	C376	QETB1HM-225	2.2MF	50V	ELECTRO	
	C377	QETB1HM-105	1MF	50V	ELECTRO	
	C378	QETB1HM-105	1MF	50V	ELECTRO	
	C379	QETB1EM-106	10MF	25V	ELECTRO	
	C380	QETB1EM-106	10MF	25V	ELECTRO	
	C381	QCF21HP-103	0.01MF	50V	CERAMIC	
	C382	QCF21HP-103	0.01MF	50V	CERAMIC	
	C383	QETB1EM-476	47MF	25V	ELECTRO	
	C384	QETB1EM-476	47MF	25V	ELECTRO	
	C385	QCF21HP-103	0.01MF	50V	CERAMIC	
	C386	QCF21HP-103	0.01MF	50V	CERAMIC	
	C387	QETB1HM-225	2.2MF	50V	ELECTRO	
	C391	QETB1HM-105	1MF	50V	ELECTRO	
	C392	QETB1HM-105	1MF	50V	ELECTRO	
	C393	QETB1EM-106	10MF	25V	ELECTRO	
	C394	QETB1EM-106	10MF	25V	ELECTRO	
	C395	QCF21HP-103	0.01MF	50V	CERAMIC	
	C396	QCF21HP-103	0.01MF	50V	CERAMIC	
	C451	QETB1CM-476	47MF	16V	ELECTRO	
	C452	QETB1AM-107	100MF	10V	ELECTRO	
	C453	QETB1CM-476	47MF	16V	ELECTRO	
	C454	QETB1AM-107	100MF	10V	ELECTRO	
	C455	QETB1EM-476	47MF	25V	ELECTRO	
	C561	QETB0JM-108	1000MF	6.3V	ELECTRO	
	C562	QCBBIHK-101	100PF	50V	CERAMIC	
	C563	QETB1EM-106	10MF	25V	ELECTRO	
	C564	QCBBIHK-101	100PF	50V	CERAMIC	
	C565	QETB0JM-108	1000MF	6.3V	ELECTRO	
	C566	QCBBIHK-101	100PF	50V	CERAMIC	
	C567	QETB1EM-106	10MF	25V	ELECTRO	
	C568	QCBBIHK-101	100PF	50V	CERAMIC	
	C569	QETB0JM-108	1000MF	6.3V	ELECTRO	
	C570	QCBBIHK-101	100PF	50V	CERAMIC	
	C571	QCF21HP-103	0.01MF	50V	CERAMIC	
	C572	QETB0JM-477	470MF	6.3V	ELECTRO	
	C573	QETB0JM-477	470MF	6.3V	ELECTRO	
	C579	QFLB1HJ-104	0.1MF	50V	MYLAR	
	C581	QETB1EM-227	220MF	25V	ELECTRO	
	C582	QETB1HM-225	2.2MF	50V	ELECTRO	
	C591	QCBBIHK-101	100PF	50V	CERAMIC	
	C592	QCBBIHK-101	100PF	50V	CERAMIC	
	C595	QCF21HP-223	0.022MF	50V	CERAMIC	
	C601	QETB1HM-475	4.7MF	50V	ELECTRO	
	C602	QETB1HM-475	4.7MF	50V	ELECTRO	
	C603	QETB1HM-475	4.7MF	50V	ELECTRO	
	C604	QCS21HJ-100	10PF	50V	CERAMIC	
	C608	QCF21HP-223	0.022MF	50V	CERAMIC	
	C609	QCF21HP-223	0.022MF	50V	CERAMIC	
	C610	QETB1CM-107	100MF	16V	ELECTRO	
	C611	QETB1HM-475	4.7MF	50V	ELECTRO	
	C612	QFLB1HK-104	0.1MF	50V	MYLAR	
	C613	QFLB1HK-104	0.1MF	50V	MYLAR	
	C614	QFLB1HK-104	0.1MF	50V	MYLAR	
	C615	QFLB1HK-104	0.1MF	50V	MYLAR	
	C616	QFLB1HJ-223	0.022MF	50V	MYLAR	
	C617	QFLB1HJ-223	0.022MF	50V	MYLAR	
	C618	QCS21HJ-681	680PF	50V	CERAMIC	
	C619	QFLB1HJ-104	0.1MF	50V	MYLAR	
	C621	QFLB1HJ-473	0.047MF	50V	MYLAR	
	C622	QFLB1HJ-104	0.1MF	50V	MYLAR	
	C623	QFLB1HJ-104	0.1MF	50V	MYLAR	
	C624	QFLB1HJ-104	0.1MF	50V	MYLAR	
	C625	QFLB1HJ-473	0.047MF	50V	MYLAR	
	C626	QCS21HJ-681	680PF	50V	CERAMIC	
	C627	QFLB1HJ-332	3300PF	50V	MYLAR	
	C628	QETB1CM-226	22MF	16V	ELECTRO	
	C629	QETB1EM-106	10MF	25V	ELECTRO	
	C631	QETB1EM-106	10MF	25V	ELECTRO	
	C632	QETB1EM-106	10MF	25V	ELECTRO	
	C633	QETB1EM-106	10MF	25V	ELECTRO	
	C634	QFV81HJ-224	0.22MF	50V	T.FILM	
	C635	QETB1EM-106	10MF	25V	ELECTRO	
	C636	QETB1EM-106	10MF	25V	ELECTRO	
	C637	QCY21HK-562	5600PF	50V	CERAMIC	
	C638	QFLB1HK-473	0.047MF	50V	MYLAR	
	C639	QETB1CM-477	470MF	16V	ELECTRO	
	C641	QCS21HJ-471	470PF	50V	CERAMIC	
	C642	QCY21HK-472	4700PF	50V	CERAMIC	
	C643	QCY21HK-562	5600PF	50V	CERAMIC	
	C644	QFV81HJ-684	0.68MF	50V	T.FILM	
	C645	QFV81HJ-224	0.22MF	50V	T.FILM	
	C646	QFV81HJ-224	0.22MF	50V	T.FILM	
	C647	QETB1HM-475	4.7MF	50V	ELECTRO	
	C648	QFV81HJ-224	0.22MF	50V	T.FILM	
	C649	QFV81HJ-224	0.22MF	50V	T.FILM	
	C650	QETB1EM-106	10MF	25V	ELECTRO	

△ DISAPPEAR PARTS

Capacitors

△	ITEM	PART NUMBER	DESCRIPTION			AREA
	C653	QEB51EM-475	4.7MF	25V	LLC ELECTRO	
	C654	QCY21HK-562	5600PF	50V	CERAMIC	
	C655	QCS21HJ-561	560PF	50V	CERAMIC	
	C656	QFLB1HK-104	0.1MF	50V	MYLAR	
	C657	QFV81HJ-474	0.47MF	50V	T.FILM	
	C658	QFV81HJ-474	0.47MF	50V	T.FILM	
	C659	QETB1CM-476	47MF	16V	ELECTRO	
	C661	QFLB1HK-104	0.1MF	50V	MYLAR	
	C662	QCS21HJ-821	820PF	50V	CERAMIC	
	C663	QCY21HK-332	3300PF	50V	CERAMIC	
	C664	QEB51EM-475	4.7MF	25V	LLC ELECTRO	
	C665	QETB1HM-475	4.7MF	50V	ELECTRO	
	C666	QCF21HP-223	0.022MF	50V	CERAMIC	
	C667	QCF21HP-223	0.022MF	50V	CERAMIC	
	C668	QCF21HP-223	0.022MF	50V	CERAMIC	
	C669	QETB1CM-107	100MF	16V	ELECTRO	
	C670	QETB1EM-106	10MF	25V	ELECTRO	
	C671	QETB1EM-106	10MF	25V	ELECTRO	
	C672	QETB1EM-106	10MF	25V	ELECTRO	
	C673	QCF21HP-223	0.022MF	50V	CERAMIC	
	C674	QCF21HP-223	0.022MF	50V	CERAMIC	
	C681	QETB1HM-105	1MF	50V	ELECTRO	
	C682	QETB1HM-105	1MF	50V	ELECTRO	
	C683	QETB1EM-106	10MF	25V	ELECTRO	
	C684	QETB1EM-106	10MF	25V	ELECTRO	
	C685	QEK51EM-226	22MF	25V	ELECTRO	
	C686	QCF21HP-223	0.022MF	50V	CERAMIC	
	C687	QETB1EM-226	22MF	25V	ELECTRO	
	C688	QETB1EM-106	10MF	25V	ELECTRO	
	C689	QETB1EM-106	10MF	25V	ELECTRO	
	C691	QEB51EM-226	22MF	25V	LLC ELECTRO	
	C697	QETB1EM-106	10MF	25V	ELECTRO	
	C698	QETB1EM-106	10MF	25V	ELECTRO	

△ DISAPPEAR PARTS

Resistors

△	ITEM	PART NUMBER	DESCRIPTION			AREA
	R253	QRD167J-471	470	1/6W	CARBON	
	R254	QRD167J-103	10K	1/6W	CARBON	
	R255	QRD167J-103	10K	1/6W	CARBON	
	R256	QRD167J-473	47K	1/6W	CARBON	
	R257	QRD167J-223	22K	1/6W	CARBON	
	R259	QRD167J-471	470	1/6W	CARBON	
	R260	QRD167J-103	10K	1/6W	CARBON	
	R261	QRD167J-103	10K	1/6W	CARBON	
	R262	QRD167J-473	47K	1/6W	CARBON	
	R263	QRD167J-223	22K	1/6W	CARBON	
	R264	QRD167J-103	10K	1/6W	CARBON	
	R265	QRD167J-103	10K	1/6W	CARBON	
	R266	QRD167J-103	10K	1/6W	CARBON	
	R271	QRD167J-102	1K	1/6W	CARBON	
	R272	QRD167J-103	10K	1/6W	CARBON	
	R273	QRD167J-103	10K	1/6W	CARBON	
	R274	QRD167J-103	10K	1/6W	CARBON	
	R275	QRD167J-104	100K	1/6W	CARBON	
	R276	QRD167J-104	100K	1/6W	CARBON	
	R277	QRD167J-104	100K	1/6W	CARBON	
	R281	QRD167J-512	5.1K	1/6W	CARBON	
	R282	QRD167J-512	5.1K	1/6W	CARBON	
	R283	QRD167J-103	10K	1/6W	CARBON	
	R284	QRD167J-103	10K	1/6W	CARBON	
	R301	QRD167J-222	2.2K	1/6W	CARBON	
	R302	QRD167J-222	2.2K	1/6W	CARBON	
	R303	QRD167J-473	47K	1/6W	CARBON	
	R304	QRD167J-473	47K	1/6W	CARBON	
	R305	QRD167J-511	510	1/6W	CARBON	
	R306	QRD167J-511	510	1/6W	CARBON	
	R307	QRD167J-393	39K	1/6W	CARBON	
	R308	QRD167J-393	39K	1/6W	CARBON	
	R309	QRD167J-474	470K	1/6W	CARBON	
	R310	QRD167J-474	470K	1/6W	CARBON	
	R311	QRD167J-104	100K	1/6W	CARBON	
	R312	QRD167J-104	100K	1/6W	CARBON	
	R313	QRZ0077-680	68	1/4W	FUSIBLE	
	R314	QRZ0077-680	68	1/4W	FUSIBLE	
	R321	QRD167J-471	470	1/6W	CARBON	
	R322	QRD167J-471	470	1/6W	CARBON	
	R323	QRD167J-471	470	1/6W	CARBON	
	R324	QRD167J-471	470	1/6W	CARBON	
	R325	QRD167J-471	470	1/6W	CARBON	
	R326	QRD167J-471	470	1/6W	CARBON	
	R327	QRD167J-471	470	1/6W	CARBON	
	R328	QRD167J-471	470	1/6W	CARBON	
	R329	QRD167J-471	470	1/6W	CARBON	
	R330	QRD167J-471	470	1/6W	CARBON	
	R331	QRD167J-471	470	1/6W	CARBON	
	R332	QRD167J-471	470	1/6W	CARBON	

△ DISAPPEAR PARTS

Resistors

Δ	ITEM	PART NUMBER	DESCRIPTION			AREA
	R333	QRD167J-471	470	1/6W	CARBON	
	R334	QRD167J-471	470	1/6W	CARBON	
	R335	QRD167J-471	470	1/6W	CARBON	
	R336	QRD167J-471	470	1/6W	CARBON	
	R337	QRD167J-471	470	1/6W	CARBON	
	R338	QRD167J-471	470	1/6W	CARBON	
	R351	QRD167J-104	100K	1/6W	CARBON	
	R352	QRD167J-104	100K	1/6W	CARBON	
	R353	QRD167J-104	100K	1/6W	CARBON	
	R354	QRD167J-104	100K	1/6W	CARBON	
Δ	R357	QRZ0077-680	68	1/4W	FUSIBLE	
Δ	R358	QRZ0077-680	68	1/4W	FUSIBLE	
	R361	QRD167J-563	56K	1/6W	CARBON	
	R362	QRD167J-563	56K	1/6W	CARBON	
	R363	QRD167J-105	1M	1/6W	CARBON	
	R364	QRD167J-105	1M	1/6W	CARBON	
	R365	QRD167J-563	56K	1/6W	CARBON	
	R366	QRD167J-563	56K	1/6W	CARBON	
	R367	QRD167J-103	10K	1/6W	CARBON	
	R368	QRD167J-103	10K	1/6W	CARBON	
	R369	QRD167J-103	10K	1/6W	CARBON	
	R370	QRD167J-103	10K	1/6W	CARBON	
	R371	QRD167J-105	1M	1/6W	CARBON	
	R372	QRD167J-105	1M	1/6W	CARBON	
	R373	QRD167J-103	10K	1/6W	CARBON	
	R374	QRD167J-103	10K	1/6W	CARBON	
	R375	QRD167J-104	100K	1/6W	CARBON	
	R376	QRD167J-753	75K	1/6W	CARBON	
	R377	QRD167J-562	5.6K	1/6W	CARBON	
	R383	QRD167J-103	10K	1/6W	CARBON	
	R384	QRD167J-103	10K	1/6W	CARBON	
	R385	QRD167J-103	10K	1/6W	CARBON	
	R386	QRD167J-103	10K	1/6W	CARBON	
	R387	QRD167J-105	1M	1/6W	CARBON	
	R388	QRD167J-105	1M	1/6W	CARBON	
Δ	R391	QRZ0077-680	68	1/4W	FUSIBLE	
Δ	R392	QRZ0077-680	68	1/4W	FUSIBLE	
	R429	QRD167J-103	10K	1/6W	CARBON	
Δ	R451	QRZ0077-100	10	1/4W	FUSIBLE	
	R452	QRD167J-272	2.7K	1/6W	CARBON	
Δ	R453	QRZ0077-100	10	1/4W	FUSIBLE	
Δ	R456	QRZ0077-100	10	1/4W	FUSIBLE	
	R457	QRD167J-272	2.7K	1/6W	CARBON	
Δ	R458	QRZ0077-100	10	1/4W	FUSIBLE	
	R561	QRD167J-750	75	1/6W	CARBON	
	R562	QRD167J-101	100	1/6W	CARBON	
	R563	QRD167J-750	75	1/6W	CARBON	
	R564	QRD167J-750	75	1/6W	CARBON	
	R565	QRD167J-101	100	1/6W	CARBON	
	R566	QRD167J-750	75	1/6W	CARBON	
	R567	QRD167J-750	75	1/6W	CARBON	
	R568	QRD167J-101	100	1/6W	CARBON	
	R569	QRD167J-221	220	1/6W	CARBON	
	R570	QRD167J-221	220	1/6W	CARBON	
	R571	QRD167J-103	10K	1/6W	CARBON	
	R572	QRD167J-103	10K	1/6W	CARBON	
	R575	QRD167J-224	220K	1/6W	CARBON	
	R577	QRD167J-104	100K	1/6W	CARBON	
	R578	QRD167J-333	33K	1/6W	CARBON	
	R581	QRD167J-471	470	1/6W	CARBON	
Δ	R582	QRD167J-471	470	1/6W	CARBON	
Δ	R591	QRZ0077-100	10	1/4W	FUSIBLE	
	R592	QRZ0077-4R7	4.7	1/4W	FUSIBLE	
	R601	QRD167J-224	220K	1/6W	CARBON	
	R602	QRD167J-224	220K	1/6W	CARBON	
	R603	QRD167J-154	150K	1/6W	CARBON	
	R604	QRD167J-154	150K	1/6W	CARBON	
	R605	QRD167J-223	22K	1/6W	CARBON	
	R606	QRD167J-224	220K	1/6W	CARBON	
	R607	QRD167J-104	100K	1/6W	CARBON	
Δ	R609	QRD14CJ-680S	68	1/4W	UNF. CARBON	
	R611	QRD167J-752	7.5K	1/6W	CARBON	
	R612	QRD167J-752	7.5K	1/6W	CARBON	
	R613	QRD167J-223	22K	1/6W	CARBON	
	R614	QRD167J-223	22K	1/6W	CARBON	
	R615	QRD167J-752	7.5K	1/6W	CARBON	
	R616	QRD167J-153	15K	1/6W	CARBON	
	R617	QRD167J-752	7.5K	1/6W	CARBON	
	R618	QRD167J-394	390K	1/6W	CARBON	
	R619	QRD167J-104	100K	1/6W	CARBON	
	R621	QRD167J-104	100K	1/6W	CARBON	
	R622	QRD167J-104	100K	1/6W	CARBON	
	R623	QRD167J-104	100K	1/6W	CARBON	
	R624	QRD167J-104	100K	1/6W	CARBON	
	R625	QRD167J-104	100K	1/6W	CARBON	
	R626	QRD167J-473	47K	1/6W	CARBON	
	R627	QRD167J-223	22K	1/6W	CARBON	
	R628	QRD167J-473	47K	1/6W	CARBON	
	R629	QRD167J-223	22K	1/6W	CARBON	
	R630	QRD167J-153	15K	1/6W	CARBON	

Δ USA/FRETIY PARTS

Resistors

Δ	ITEM	PART NUMBER	DESCRIPTION			AREA
	R631	QRD167J-153	15K	1/6W	CARBON	
	R632	QRD167J-822	8.2K	1/6W	CARBON	
	R633	QRD167J-822	8.2K	1/6W	CARBON	
	R634	QRD167J-822	8.2K	1/6W	CARBON	
	R635	QRD167J-334	330K	1/6W	CARBON	
Δ	R641	QRD14CJ-680S	68	1/4W	UNF. CARBON	
Δ	R642	QRD14CJ-680S	68	1/4W	UNF. CARBON	
	R643	QRD167J-222	2.2K	1/6W	CARBON	
	R644	QRD167J-222	2.2K	1/6W	CARBON	
	R651	QRD167J-105	1M	1/6W	CARBON	
	R652	QRD167J-153	15K	1/6W	CARBON	
	R653	QRD167J-103	10K	1/6W	CARBON	
	R654	QRD167J-153	15K	1/6W	CARBON	
	R655	QRD167J-153	15K	1/6W	CARBON	
	R656	QRD167J-153	15K	1/6W	CARBON	
	R657	QRD167J-273	27K	1/6W	CARBON	
	R658	QRD167J-822	8.2K	1/6W	CARBON	
	R659	QRD167J-473	47K	1/6W	CARBON	
	R660	QRD167J-153	15K	1/6W	CARBON	
	R663	QRD167J-104	100K	1/6W	CARBON	
	R664	QRD167J-563	56K	1/6W	CARBON	
	R665	QRD167J-563	56K	1/6W	CARBON	
	R666	QRD167J-563	56K	1/6W	CARBON	
Δ	R669	QRD14CJ-680S	68	1/4W	UNF. CARBON	
	R670	QRD167J-682	6.8K	1/6W	CARBON	
	R672	QRD167J-103	10K	1/6W	CARBON	
	R673	QRD167J-222	2.2K	1/6W	CARBON	
	R674	QRD167J-104	100K	1/6W	CARBON	
	R675	QRD167J-472	4.7K	1/6W	CARBON	
	R676	QRD167J-473	47K	1/6W	CARBON	
	R677	QRD167J-104	100K	1/6W	CARBON	
	R678	QRD167J-475	4.7M	1/6W	CARBON	
	R679	QRD167J-224	220K	1/6W	CARBON	
	R681	QRD167J-333	33K	1/6W	CARBON	
	R682	QRD167J-333	33K	1/6W	CARBON	
	R683	QRD167J-104	100K	1/6W	CARBON	
	R684	QRD167J-104	100K	1/6W	CARBON	
	R685	QRD167J-104	100K	1/6W	CARBON	
	R686	QRD167J-104	100K	1/6W	CARBON	
	R688	QRD167J-203	20K	1/6W	CARBON	
	R689	QRD167J-103	10K	1/6W	CARBON	
	R690	QRD167J-203	20K	1/6W	CARBON	
	R691	QRD167J-103	10K	1/6W	CARBON	
	R692	QRD167J-103	10K	1/6W	CARBON	
	R693	QRD167J-103	10K	1/6W	CARBON	
	R694	QRD167J-183	18K	1/6W	CARBON	
	R695	QRD167J-104	100K	1/6W	CARBON	
Δ	R697	QRD14CJ-680S	68	1/4W	UNF. CARBON	
Δ	R698	QRD14CJ-680S	68	1/4W	UNF. CARBON	

Δ USA/FRETIY PARTS

Others

Δ	ITEM	PART NUMBER	DESCRIPTION			AREA
		EMW10082-003	CIRCUIT BOARD			
		E307528-001	SHIELD COVER			
		E307529-001	SHIELD PLATE			
		E3400-431	SPACER			
		QWE371-13DD	SOCKET WIRE			
	J301	EMN00TV-405AJ2	4P PIN JACK			
	J302	EMN00TV-602AJ2	6P PIN JACK			
	J303	EMN00TV-602AJ2	6P PIN JACK			
	J304	EMN00TV-405AJ2	4P PIN JACK			
	J561	EMN00YV-304A	3P PIN JACK			
	J562	EMN00YV-205A	2P PIN JACK			
	J571	QMS3L10-0A0	MINI JACK			
	J572	QMS3L10-0A0	MINI JACK			
	J591	EMN00YV-206A	2P PIN JACK			
	P308	EMV5109-003A	PLUG ASSY (3PIN)			
	P309	EMV5109-003A	PLUG ASSY (3PIN)			
	P402	VMC0107-004	CONNECT TERMINAL (4PIN)			
	P405	EMV5109-003A	PLUG ASSY (3PIN)			
	P406	EMV5109-003A	PLUG ASSY (3PIN)			
	P561	VMC0107-004	CONNECT TERMINAL (4PIN)			
	P591	EMV5109-003A	PLUG ASSY (3PIN)			
	P802	EMV5109-007A	PLUG ASSY (7PIN)			
	P852	VMC0107-004	CONNECT TERMINAL (4PIN)			
	P853	VMC0107-003	CONNECT TERMINAL (3PIN)			
	EP301	E70859-001	EARTH PLATE			
	EP302	E70859-001	EARTH PLATE			
	FW101	EWR388-16LST	FLAT WIRE (8PIN)			
	FW103	EWR36B-25LST	FLAT WIRE (6PIN)			
	FW307	EWS293-0125	SOCKET WIRE (3PIN)			
	FW405	EWS293-0116	SOCKET WIRE (3PIN)			
	FW406	EWS293-0125	SOCKET WIRE (3PIN)			
	FW561	EWR34B-08LST	FLAT WIRE (4PIN)			
	FW591	EWS293-0120	SOCKET WIRE (8PIN)			
	PA651	EMV7125-008R	CONNECTOR (8PIN)			
	PA671	EMV7125-013R	CONNECTOR (13PIN)			
	PB302	VMC0177-013	CONNECTOR (13PIN)			
	PB401	EMV7123-032	CONNECTOR (32PIN)			
	PB403	EMV5125-012	PLUG ASSY (12PIN)			
	PB651	EMV5125-008	PLUG ASSY (8PIN)			
	PB671	EMV5125-013	PLUG ASSY (13PIN)			
	PB681	EMV5125-007	PLUG ASSY (7PIN)			
	XT651	ECX0003-270KM	RESONATOR			

Δ USA/FRETIY PARTS

■ ENB-123 □ Control PC Board Ass'y

Note : ENB-123 □ varies according to the areas employed. See note (1) when placing an order.

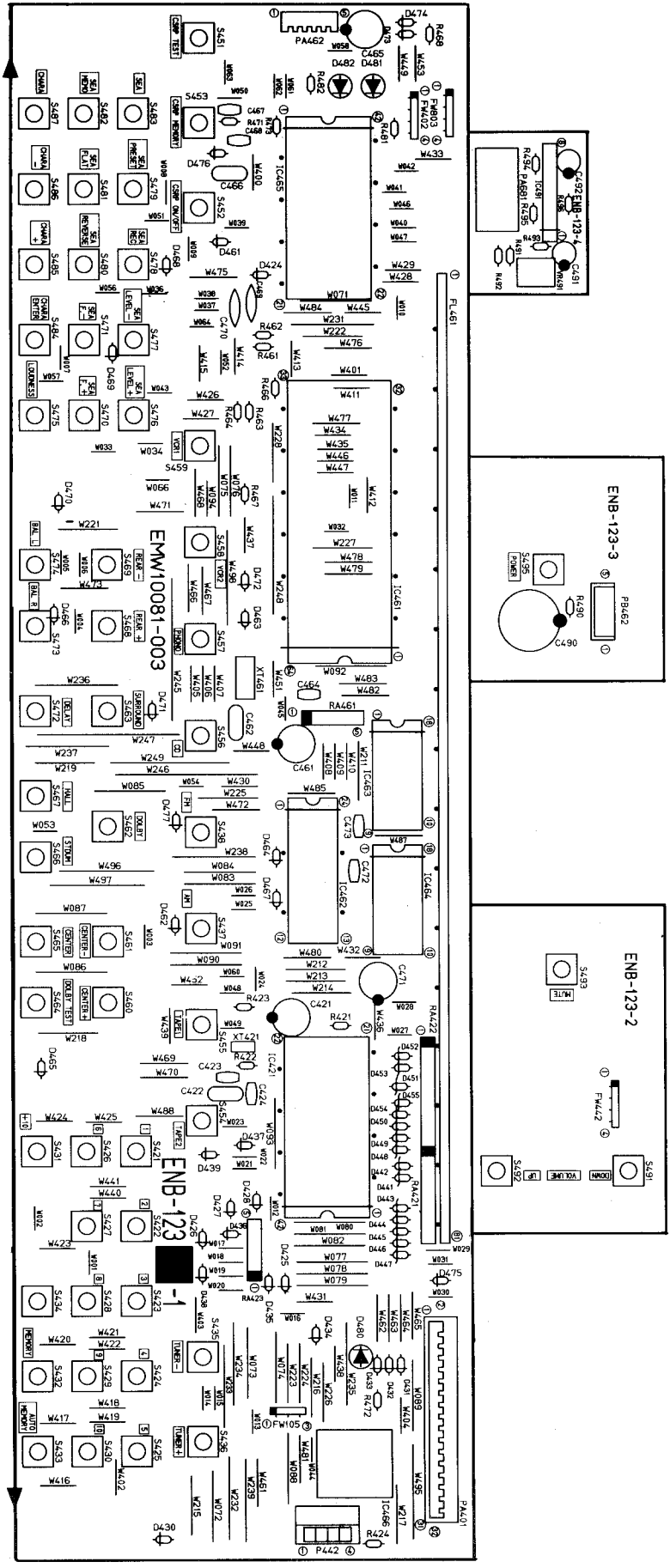

Note (1)

PC Board Ass'y	Designated Areas
ENB-123 A	the U.S.A. , Canada
ENB-123 B	Universal Type
ENB-123 C	Australia
ENB-123 D	Continental Europe (with LW)
ENB-123 E	Germany (with LW)

I.C.s

Δ	ITEM	PART NUMBER	DESCRIPTION	AREA
	IC421	LC6514B-4131	I.C. SANYO	
	IC461	MN171202JNV	I.C. MATSUSHITA	
	IC462	TC74HC154AP	I.C. TOSHIBA	
	IC463	MSL915ARS	I.C. NIHON DENSO	
	IC464	MSL915ARS	I.C. NIHON DENSO	
	IC465	MSC7112-01SS	I.C. NIHON DENSO	
	IC466	SPS-420-1	I.C. SANYO	
	IC491	VC4580L	I.C. DAINICHI	

▲ DISAPPEARING PARTS

Diodes

Δ	ITEM	PART NUMBER	DESCRIPTION	AREA
	D424	1SS133	SILICON ROHM	
	D425	1SS133	SILICON ROHM	
	D426	1SS133	SILICON ROHM	
	D427	1SS133	SILICON ROHM	
	D428	1SS133	SILICON ROHM	
	D430	1SS133	SILICON ROHM	
	D431	1SS133	SILICON ROHM	
	D432	1SS133	SILICON ROHM	
	D433	1SS133	SILICON ROHM	
	D434	1SS133	SILICON ROHM	
	D435	1SS133	SILICON ROHM	
	D436	1SS133	SILICON ROHM	A
	D437	1SS133	SILICON ROHM	C
	D437	1SS133	SILICON ROHM	D
	D437	1SS133	SILICON ROHM	E
	D438	1SS133	SILICON ROHM	D
	D438	1SS133	SILICON ROHM	E
	D439	1SS133	SILICON ROHM	B
	D441	MTZ8.2JC	ZENER ROHM	
	D442	MTZ8.2JC	ZENER ROHM	
	D443	MTZ8.2JC	ZENER ROHM	
	D444	MTZ8.2JC	ZENER ROHM	
	D445	MTZ8.2JC	ZENER ROHM	
	D446	MTZ8.2JC	ZENER ROHM	
	D447	MTZ8.2JC	ZENER ROHM	
	D448	MTZ8.2JC	ZENER ROHM	
	D449	MTZ8.2JC	ZENER ROHM	
	D450	MTZ8.2JC	ZENER ROHM	
	D451	MTZ8.2JC	ZENER ROHM	
	D452	MTZ8.2JC	ZENER ROHM	
	D453	MTZ8.2JC	ZENER ROHM	
	D454	MTZ8.2JC	ZENER ROHM	
	D455	MTZ8.2JC	ZENER ROHM	
	D461	1SS133	SILICON ROHM	
	D462	1SS133	SILICON ROHM	
	D463	1SS133	SILICON ROHM	
	D464	1SS133	SILICON ROHM	
	D465	1SS133	SILICON ROHM	
	D466	1SS133	SILICON ROHM	
	D467	1SS133	SILICON ROHM	
	D468	1SS133	SILICON ROHM	
	D469	1SS133	SILICON ROHM	
	D470	1SS133	SILICON ROHM	
	D471	1SS133	SILICON ROHM	
	D472	1SS133	SILICON ROHM	
	D473	1SS133	SILICON ROHM	
	D474	1SS133	SILICON ROHM	
	D475	1SS133	SILICON ROHM	
	D476	1SS133	SILICON ROHM	
	D477	1SS133	SILICON ROHM	
	D480	SLR-34VC70F124	L.E.D. ROHM	
	D481	SLR-34DC70F124	L.E.D. ROHM	
	D482	SLR-34DC70F124	L.E.D. ROHM	

▲ DISAPPEARING PARTS

Capacitors

Δ	ITEM	PART NUMBER	DESCRIPTION	AREA
	C421	QER40JM-337E	330MF 6.3V ELECTRO	
	C422	QCZ0202-155	1.5MF 25V CERAMIC	
	C423	QCBB1HK-101	100PF 50V CERAMIC	
	C424	QCBB1HK-101	100PF 50V CERAMIC	
	C461	QER40JM-337E	330MF 6.3V ELECTRO	
	C462	QCZ0202-155	1.5MF 25V CERAMIC	
	C464	QCGB1HK-102	1000PF 50V CERAMIC	
	C465	QETB1AM-107	100MF 10V ELECTRO	
	C466	QCZ0202-155	1.5MF 25V CERAMIC	
	C467	QCBB1HK-101	100PF 50V CERAMIC	
	C468	QCBB1HK-221	220PF 50V CERAMIC	
	C469	QCZ0202-155	1.5MF 25V CERAMIC	
	C470	QCZ0202-155	1.5MF 25V CERAMIC	
	C471	QER41HM-336E	33MF 50V ELECTRO	
	C472	QC8B1EZ-223	0.022MF 25V CERAMIC	
	C473	QC8B1EZ-223	0.022MF 25V CERAMIC	
	C490	EEZ0503-479	47000MF ELECTRO	
	C491	QEK51CM-106G	10MF 16V ELECTRO	
	C492	QEK51CM-106G	10MF 16V ELECTRO	

▲ DISAPPEARING PARTS

Resistors

Δ	ITEM	PART NUMBER	DESCRIPTION	AREA
	R421	QRD167J-105	1M 1/6W CARBON	
	R422	QRD167J-152	1.5K 1/6W CARBON	
	R423	QRD167J-272	2.7K 1/6W CARBON	
	R424	QRD167J-221	220 1/6W CARBON	
	R461	QRD167J-473	47K 1/6W CARBON	
	R462	QRD167J-473	47K 1/6W CARBON	
	R463	QRD167J-473	47K 1/6W CARBON	
	R464	QRD167J-473	47K 1/6W CARBON	
	R466	QRD167J-104	100K 1/6W CARBON	
	R467	QRD167J-104	100K 1/6W CARBON	
	R468	QRD167J-3R9	3.9 1/6W CARBON	
	R471	QRD167J-104	100K 1/6W CARBON	
	R472	QRD167J-221	220 1/6W CARBON	
	R473	QRD167J-273	27K 1/6W CARBON	
	R481	QRD167J-221	220 1/6W CARBON	
	R482	QRD167J-221	220 1/6W CARBON	
	R490	QRD167J-331	330 1/6W CARBON	
	R491	QRD167J-104	100K 1/6W CARBON	
	R492	QRD167J-104	100K 1/6W CARBON	
	R493	QRD167J-223	22K 1/6W CARBON	
	R494	QRD167J-223	22K 1/6W CARBON	
	R495	QRD167J-333	33K 1/6W CARBON	
	R496	QRD167J-333	33K 1/6W CARBON	
	RA421	QRB075J-104	100K 1/8W R.NETWORK	
	RA422	QRB085J-104	100K 1/8W R.NETWORK	
	RA423	QRB045J-473	47K 1/8W R.NETWORK	
	RA461	QRB045J-103	10K 1/8W R.NETWORK	
	VR491	QVPA603-104M	100K VARIABLE	

▲ DISAPPEARING PARTS

Others

Δ	ITEM	PART NUMBER	DESCRIPTION	AREA
		EMW10081-003(S)	CIRCUIT BOARD	
		E306805-028	SPACER	
		E307475-003	FL HOLDER	
	P442	VMC0107-004	CONNECT TERMINAL (4PIN)	
	S421	ESP0001-018	TACT SWITCH (1)	
	S422	ESP0001-018	TACT SWITCH (2)	
	S423	ESP0001-018	TACT SWITCH (3)	
	S424	ESP0001-018	TACT SWITCH (4)	
	S425	ESP0001-018	TACT SWITCH (5)	
	S426	ESP0001-018	TACT SWITCH (6)	
	S427	ESP0001-018	TACT SWITCH (7)	
	S428	ESP0001-018	TACT SWITCH (8)	
	S429	ESP0001-018	TACT SWITCH (9)	
	S430	ESP0001-018	TACT SWITCH (10)	
	S431	ESP0001-018	TACT SWITCH (+10)	
	S432	ESP0001-018	TACT SWITCH (MEMO)	
	S433	ESP0001-018	TACT SWITCH (AUTO MEMO)	
	S434	ESP0001-018	TACT SWITCH (FM MODE MUTE)	
	S435	ESP0001-018	TACT SWITCH (TUNE DOWN)	
	S436	ESP0001-018	TACT SWITCH (TUNE UP)	
	S437	ESP0001-018	TACT SWITCH (AM)	
	S438	ESP0001-018	TACT SWITCH (FM)	
	S451	ESP0001-018	TACT SWITCH (CSRFP TEST)	
	S452	ESP0001-018	TACT SWITCH (CSRFP ON/OFF)	
	S453	ESP0001-018	TACT SWITCH (CSRFP MEMORY)	
	S454	ESP0001-018	TACT SWITCH (TAPE2)	
	S455	ESP0001-018	TACT SWITCH (TAPE1)	
	S456	ESP0001-018	TACT SWITCH (CD)	
	S457	ESP0001-018	TACT SWITCH (PHONE)	
	S458	ESP0001-018	TACT SWITCH (VCR2)	

▲ DISAPPEARING PARTS

Others

ITEM	PART NUMBER	DESCRIPTION	AREA
S459	ESP0001-018	TACT SWITCH (VCR1)	
S460	ESP0001-018	TACT SWITCH (CENTER +)	
S461	ESP0001-018	TACT SWITCH (CENTER -)	
S462	ESP0001-018	TACT SWITCH (DOLBY)	
S463	ESP0001-018	TACT SWITCH (SURROUND)	
S464	ESP0001-018	TACT SWITCH (DOLBY TEST)	
S465	ESP0001-018	TACT SWITCH (CENTER)	
S466	ESP0001-018	TACT SWITCH (STADIUM)	
S467	ESP0001-018	TACT SWITCH (HALL)	
S468	ESP0001-018	TACT SWITCH (REAR +)	
S469	ESP0001-018	TACT SWITCH (REAR -)	
S470	ESP0001-018	TACT SWITCH (SEA F +)	
S471	ESP0001-018	TACT SWITCH (SEA F -)	
S472	ESP0001-018	TACT SWITCH (DELAY)	
S473	ESP0001-018	TACT SWITCH (BAL R)	
S474	ESP0001-018	TACT SWITCH (BAL L)	
S475	ESP0001-018	TACT SWITCH (LOUDNESS)	
S476	ESP0001-018	TACT SWITCH (SEA LEVEL +)	
S477	ESP0001-018	TACT SWITCH (SEA LEVEL -)	
S478	ESP0001-018	TACT SWITCH (SEA REC)	
S479	ESP0001-018	TACT SWITCH (SEA PRESET)	
S480	ESP0001-018	TACT SWITCH (SEA REVERSE)	
S481	ESP0001-018	TACT SWITCH (SEA FLAT)	
S482	ESP0001-018	TACT SWITCH (SEA MEMO)	
S483	ESP0001-018	TACT SWITCH (SEA)	
S484	ESP0001-018	TACT SWITCH (CHARA ENTER)	
S485	ESP0001-018	TACT SWITCH (CHARA +)	
S486	ESP0001-018	TACT SWITCH (CHARA -)	
S487	ESP0001-018	TACT SWITCH (CHARA)	
S491	ESP0001-018	TACT SWITCH (VOLUME -)	
S492	ESP0001-018	TACT SWITCH (VOLUME +)	
S493	ESP0001-018	TACT SWITCH (MUTE)	
S495	ESP0001-018	TACT SWITCH (POWER)	
FL461	ELU0001-115	FL TUBE	
FW105	EWR33B-45LST	FLAT WIRE (3PIN)	B
FW402	EWR34B-35LST	FLAT WIRE (4PIN)	
FW442	EWR34B-08LST	FLAT WIRE (4PIN)	
FW803	EWR34B-16LST	FLAT WIRE (4PIN)	
PA401	EMV7123-032	CONNECTOR (32PIN)	
PA462	VMC0194-PO5	CONNECTOR (6PIN)	
PA681	EMV7125-007R	CONNECTOR (7PIN)	
PB462	VMC0194-S05	FEMALE CONNECTOR (5PIN)	
XT421	ECX0001-000KS	RESONATOR	
XT461	ECX0060-000EM	RESONATOR	

△ DISASSEMBLY PARTS

■ ENF-061A SEA PC Board Ass'y

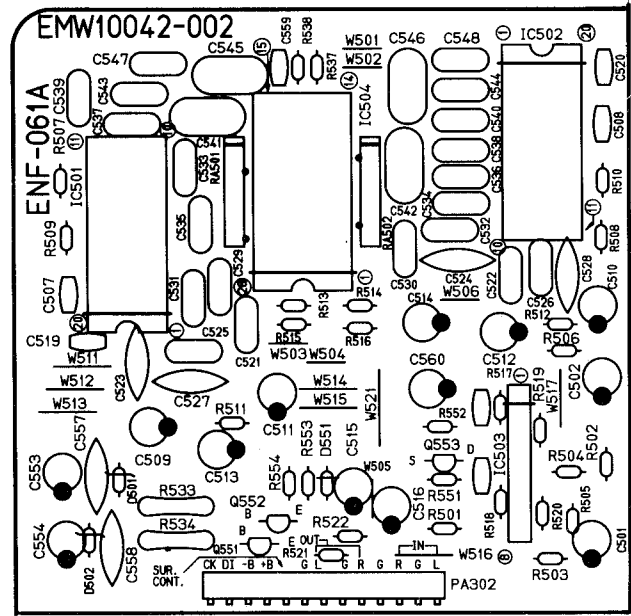

Transistors

ITEM	PART NUMBER	DESCRIPTION	AREA
Q551	DTC144ES	SILICON ROHM	
Q552	DTA144ES	SILICON ROHM	
Q553	2SK301(P,Q)	F.E.T MATSUSHITA	

△ DISASSEMBLY PARTS

I.C.s

ITEM	PART NUMBER	DESCRIPTION	AREA
IC501	LA3607S	I.C. SANYO	
IC502	LA3607S	I.C. SANYO	
IC503	VC4580LD	I.C. DAINICHI	
IC504	LC7522	I.C. SANYO	

△ DISASSEMBLY PARTS

Diodes

ITEM	PART NUMBER	DESCRIPTION	AREA
D501	MTZ6.8JC	ZENER ROHM	
D502	MTZ6.8JC	ZENER ROHM	

△ DISASSEMBLY PARTS

Capacitors

ITEM	PART NUMBER	DESCRIPTION	AREA
C501	QETB1HM-475	4.7MF 50V ELECTRO	
C502	QETB1HM-475	4.7MF 50V ELECTRO	
C507	QCB1HK-101	100PF 50V CERAMIC	
C508	QCB1HK-101	100PF 50V CERAMIC	
C509	QETB1CM-226	22MF 16V ELECTRO	
C510	QETB1CM-226	22MF 16V ELECTRO	
C511	QETB1HM-475	4.7MF 50V ELECTRO	
C512	QETB1HM-475	4.7MF 50V ELECTRO	
C513	QETB1HM-475	4.7MF 50V ELECTRO	
C514	QETB1HM-475	4.7MF 50V ELECTRO	
C515	QETB1HM-475	4.7MF 50V ELECTRO	
C516	QETB1HM-475	4.7MF 50V ELECTRO	
C521	QFLB1HK-272	2700PF 50V MYLAR	
C522	QFLB1HK-272	2700PF 50V MYLAR	
C523	QCS21HJ-471	470PF 50V CERAMIC	
C524	QCS21HJ-471	470PF 50V CERAMIC	
C525	QFLB1HK-682	6800PF 50V MYLAR	
C526	QFLB1HK-682	6800PF 50V MYLAR	
C527	QCY21HK-122	1200PF 50V CERAMIC	
C528	QCY21HK-122	1200PF 50V CERAMIC	

△ DISASSEMBLY PARTS

■ ENB-130 [A] SPI PC Board Ass'y

Capacitors

ITEM	PART NUMBER	DESCRIPTION	AREA
C529	QFLB1HK-183	0.018MF 50V MYLAR	
C530	QFLB1HK-183	0.018MF 50V MYLAR	
C531	QFLB1HK-272	2700PF 50V MYLAR	
C532	QFLB1HK-272	2700PF 50V MYLAR	
C533	QFLB1HK-473	0.047MF 50V MYLAR	
C534	QFLB1HK-473	0.047MF 50V MYLAR	
C535	QFLB1HK-682	6800PF 50V MYLAR	
C536	QFLB1HK-682	6800PF 50V MYLAR	
C537	QFLB1HK-104	0.1MF 50V MYLAR	
C538	QFLB1HK-104	0.1MF 50V MYLAR	
C539	QFLB1HK-183	0.018MF 50V MYLAR	
C540	QFLB1HK-183	0.018MF 50V MYLAR	
C541	QFV81HJ-274	0.27MF 50V T.FILM	
C542	QFV81HJ-274	0.27MF 50V T.FILM	
C543	QFLB1HK-473	0.047MF 50V MYLAR	
C544	QFLB1HK-473	0.047MF 50V MYLAR	
C545	QFV81HJ-684	0.68MF 50V T.FILM	
C546	QFV81HJ-684	0.68MF 50V T.FILM	
C547	QFV81HJ-124	0.12MF 50V T.FILM	
C548	QFV81HJ-124	0.12MF 50V T.FILM	
C553	QETB1HM-475	4.7MF 50V ELECTRO	
C554	QETB1HM-475	4.7MF 50V ELECTRO	
C557	QCF21HP-223	0.022MF 50V CERAMIC	
C558	QCF21HP-223	0.022MF 50V CERAMIC	
C559	QCHB1EZ-223	0.022MF 25V CERAMIC	
C560	QEK51HM-2246	0.22MF 50V ELECTRO	

▲ SAFETY PARTS

Resistors

ITEM	PART NUMBER	DESCRIPTION	AREA
R501	QRD167J-243	24K 1/6W CARBON	
R502	QRD167J-243	24K 1/6W CARBON	
R503	QRD167J-275	2.7M 1/6W CARBON	
R504	QRD167J-275	2.7M 1/6W CARBON	
R505	QRD167J-275	2.7M 1/6W CARBON	
R506	QRD167J-275	2.7M 1/6W CARBON	
R507	QRD167J-102	1K 1/6W CARBON	
R508	QRD167J-102	1K 1/6W CARBON	
R509	QRD167J-103	10K 1/6W CARBON	
R510	QRD167J-103	10K 1/6W CARBON	
R511	QRD167J-103	10K 1/6W CARBON	
R512	QRD167J-103	10K 1/6W CARBON	
R513	QRD167J-224	220K 1/6W CARBON	
R514	QRD167J-224	220K 1/6W CARBON	
R515	QRD167J-154	150K 1/6W CARBON	
R516	QRD167J-154	150K 1/6W CARBON	
R517	QRD167J-682	6.8K 1/6W CARBON	
R518	QRD167J-682	6.8K 1/6W CARBON	
R519	QRD167J-103	10K 1/6W CARBON	
R520	QRD167J-103	10K 1/6W CARBON	
R521	QRD167J-104	100K 1/6W CARBON	
R522	QRD167J-104	100K 1/6W CARBON	
R533	QRD14CJ-221S	220 1/4W UNF. CARBON	
R534	QRD14CJ-271S	270 1/4W UNF. CARBON	
R537	QRD167J-681	680 1/6W CARBON	
R538	QRD167J-272	2.7K 1/6W CARBON	
R551	QRD167J-105	1M 1/6W CARBON	
R552	QRD167J-562	5.6K 1/6W CARBON	
R553	QRD167J-105	1M 1/6W CARBON	
R554	QRD167J-105	1M 1/6W CARBON	
RA501	GRB079J-474	470K 1/10W R.NETWORK	
RA502	GRB079J-474	470K 1/10W R.NETWORK	

▲ SAFETY PARTS

Others

ITEM	PART NUMBER	DESCRIPTION	AREA
PA302	EMW10042-003(S) VMC0178-013L	CIRCUIT BOARD CONNECTOR (18PIN)	

▲ SAFETY PARTS

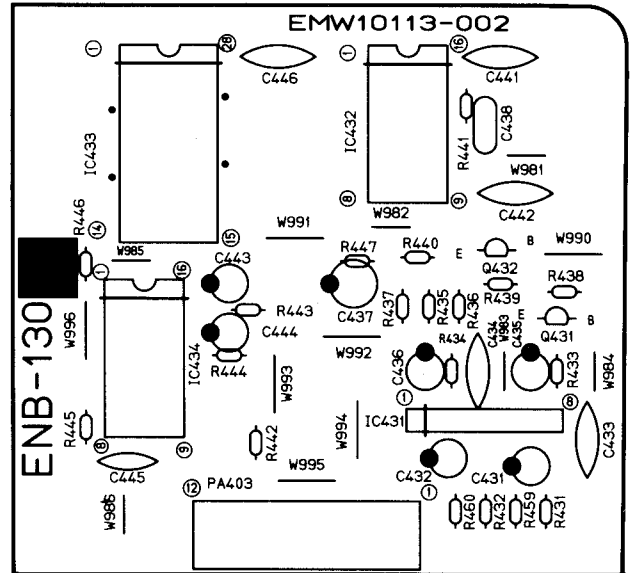

Transistors

ITEM	PART NUMBER	DESCRIPTION	AREA
Q431	2SC1685(R,S)	SILICON MATSUSHITA	
Q432	2SC1685(R,S)	SILICON MATSUSHITA	

▲ SAFETY PARTS

I.C.s

ITEM	PART NUMBER	DESCRIPTION	AREA
IC431	VC4580L	I.C. DAINICHI	
IC432	XR-1091DCP	I.C. EXAR JAPAN	
IC433	TC9162N	I.C. TOSHIBA	
IC434	UPD7001C	I.C. NEC	

▲ SAFETY PARTS

Capacitors

ITEM	PART NUMBER	DESCRIPTION	AREA
C431	QETB1HM-105	1MF 50V ELECTRO	
C432	QETB1HM-105	1MF 50V ELECTRO	
C433	QCF21HP-103	0.01MF 50V CERAMIC	
C434	QCF21HP-103	0.01MF 50V CERAMIC	
C435	QETB1HM-105	1MF 50V ELECTRO	
C436	QETB1HM-105	1MF 50V ELECTRO	
C437	QETB1HM-474	0.47MF 50V ELECTRO	
C438	QFLB1HK-102	1000PF 50V MYLAR	
C441	QCF21HP-103	0.01MF 50V CERAMIC	
C442	QCF21HP-103	0.01MF 50V CERAMIC	
C443	QETB1CM-476	47MF 16V ELECTRO	
C444	QETB1CM-476	47MF 16V ELECTRO	
C445	QCS21HJ-470	47PF 50V CERAMIC	
C446	QCF21HP-103	0.01MF 50V CERAMIC	
C447	QCS21HJ-680	68PF 50V CERAMIC	
C448	QCS21HJ-680	68PF 50V CERAMIC	
C449	QCF21HP-223	0.022MF 50V CERAMIC	
C450	QCS21HJ-681	680PF 50V CERAMIC	

▲ SAFETY PARTS

Resistors

△	ITEM	PART NUMBER	DESCRIPTION			AREA
	R431	QRD167J-105	1M	1/6W	CARBON	
	R432	QRD167J-105	1M	1/6W	CARBON	
	R433	QRD167J-153	15K	1/6W	CARBON	
	R434	QRD167J-153	15K	1/6W	CARBON	
	R435	QRD167J-563	56K	1/6W	CARBON	
	R436	QRD167J-563	56K	1/6W	CARBON	
	R437	QRD167J-103	10K	1/6W	CARBON	
	R438	QRD167J-562	5.6K	1/6W	CARBON	
	R439	QRD167J-103	10K	1/6W	CARBON	
	R440	QRD167J-393	39K	1/6W	CARBON	
	R441	QRD167J-152	1.5K	1/6W	CARBON	
	R442	QRD167J-470	47	1/6W	CARBON	
	R443	QRD167J-223	22K	1/6W	CARBON	
	R444	QRD167J-223	22K	1/6W	CARBON	
	R445	QRD167J-273	27K	1/6W	CARBON	
	R446	QRD167J-682	6.8K	1/6W	CARBON	
	R447	QRD167J-104	100K	1/6W	CARBON	
	R459	QRD167J-104	100K	1/6W	CARBON	
	R460	QRD167J-104	100K	1/6W	CARBON	

△ SAFETY PARTS

Others

△	ITEM	PART NUMBER	DESCRIPTION	AREA
	PA403	EMW10113-002(S) E3400-431 EMV7125-012R	CIRCUIT BOARD SPACER CONNECTOR (12PIN)	

△ SAFETY PARTS

Accessories List

△	Part Number	Part Name	Q'ty	Description	Areas
	E30580-1697B	Instruction Book	1		J
	E30580-1698A	Instruction Book	1		Except J
	BT-20048D	Warranty Card	1		J
	BT-20025K	Warranty Card	1		C
	BT-20117	Warranty Card	1		LG
	BT-20122	Audio Warranty Card	1	for New Zealand	A
	BT-20122-1	LTD Sticker	1	for New Zealand	A
	BT-20044G	Safety Instruction Sheet	1		J
	BT-20108A	Service Information Card	1		J
	BT20071A	Service Center List	1		C
△	E04056	Siemens Plug	1		U
△	QMF51E2-5R0J1	Fuse	1		U
	E67142-T5R0	Fuse Label	1		U
	E35497-015	Caution Sheet	1	220V	U
	EWP502-001	Built in Antenna	1		Except LG
△	E67007-001	Wire Antenna	1		LG
	QZL1008-001	FTZ Information Sheet	1		LG
	EMZ2001-011	Adapter	1		LE, LEF
	E304084-001	Loop Stand	1		LE, LEF, LG
	EQB4001-015	AM Loop Antenna	1		
	RM-SR805U	Remote Controller	1		
	AM4J-2PSA	Battery	1		
	E66416-003	Envelope	1	for Warranty Card	J
	QPGA005-00703	Envelope	1	for Fuse and Fuse Label	U
	QPGA025-03505	Envelope	2		

The Marks for Designated Areas

J.....the U.S.A. LG.....Germany (with LW)
 C.....Canada U.....Universal Type
 A.....Australia **No mark indicates all areas.**
 LE,LEF.....Continental Europe (with LW)

△ Safety Parts

Packing Materials and Part Numbers

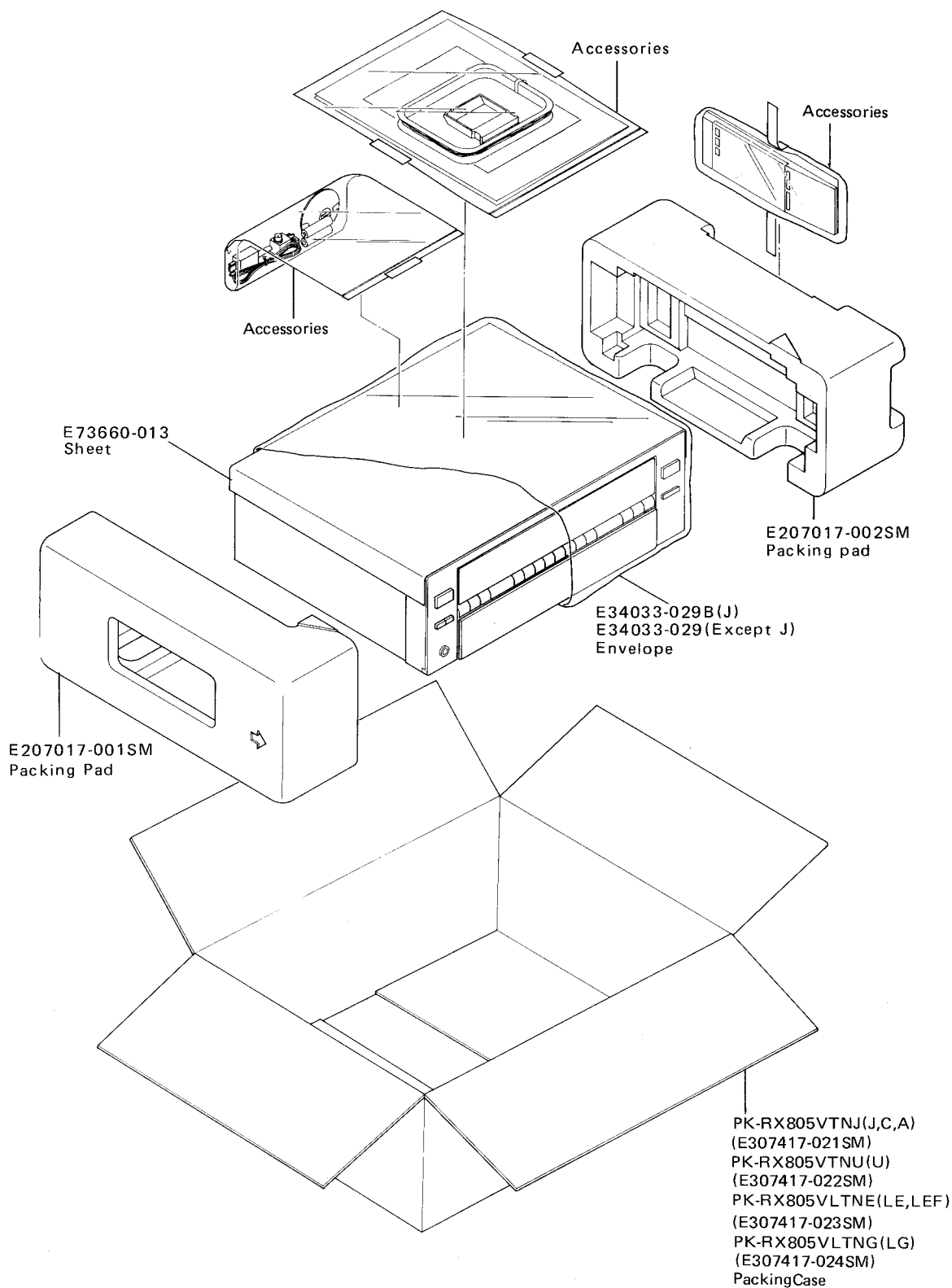

The Marks for Designated Areas

J.....the U.S.A.	LG.....Germany (with LW)
C.....Canada	U.....Universal Type
A.....Australia	No mark indicates all areas.
LE,LEF.....Continental Europe (with LW)	

JVC

VICTOR COMPANY OF JAPAN, LIMITED

AUDIO PRODUCTS DIVISION, 1644, SHIMOTSURUMA, YAMATO-SHI, KANAGAWA-KEN, 242, JAPAN

