

STEREO TUNER (FT-M1)

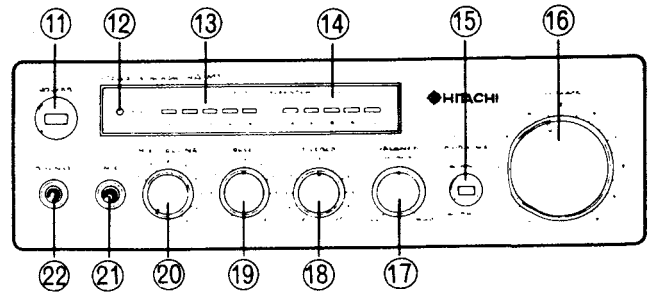

STEREO AMPLIFIER (HA-M1)

### KEY TO ILLUSTRATIONS

#### <STEREO TUNER (FT-M1)>

- ① TAPE MONITOR SWITCH
- ② MODE SWITCH
- ③ AUX SWITCH
- ④ PHONO SWITCH
- ⑤ FM BAND SWITCH
- ⑥ AM BAND SWITCH
- ⑦ HI-BLEND SWITCH
- ⑧ TUNING CONTROL
- ⑨ FM STEREO INDICATOR
- ⑩ TUNING INDICATOR

#### <STEREO AMPLIFIER (HA-M1)>

- ⑪ POWER (MAINS) SWITCH
- ⑫ POWER (MAINS) INDICATOR
- ⑬ LEVEL INDICATOR (LEFT)
- ⑭ LEVEL INDICATOR (RIGHT)
- ⑮ LOUDNESS SWITCH
- ⑯ VOLUME CONTROL
- ⑰ BALANCE CONTROL
- ⑱ TREBLE CONTROL
- ⑲ BASS CONTROL
- ⑳ MIXING VOLUME CONTROL
- ㉑ MICROPHONE SOCKET
- ㉒ HEADPHONE SOCKET

### SAFETY PRECAUTION

The following precautions should be observed when servicing.

1. Since many parts in the unit have special safety related characteristics, always use genuine Hitachi's replacement parts. Especially critical parts in the power circuit block should not be replaced with other makers. Critical parts are marked with  $\Delta$  in the schematic diagram, and circuit board diagram.
2. Before returning a repaired unit to the customer, the service technician must thoroughly test the unit to ascertain that it is completely safe to operate without danger of electrical shock.

## STEREO TUNER/STEREO AMPLIFIER

**SPECIFICATIONS**

**FT-M1 (AM-FM STEREO TUNER)**

**GENERAL SPECIFICATION**

Semi-conductors :	IC's : 4 Transistors : 16 FET : 1 LED's : 9 Diodes : 10
Dimensions (H×W×D) :	7.4 (include the foot)×23.0×16.0cm
Weight :	1.8 kg

**TUNER SECTION**

Circuit system :	FM/AM 2 band superheterodyne
Frequency range :	FM : 87.5 to 108 MHz AM : 530 to 1605 kHz
Sensitivity :	FM : 2.0 $\mu$ V (THD 3%, 400 Hz 75 kHz Dev.) AM : 250 $\mu$ V/m (S/N 20 dB, 400 Hz 30% mod.)
FM capture ratio :	2 dB (1mV, 75 kHz)
FM selectivity :	45 dB ( $\pm$ 400 kHz)
Harmonic distortion :	0.5%
FM stereo separation :	40 dB (1 kHz)
FM Pilot suppression :	35 dB (19 kHz/38 kHz)
AM suppression :	40 dB
Image rejection :	50 dB
Intermediate frequency :	$f_{IF}$ : 10.7 MHz $f_{AM}$ : 455 kHz
Antenna (aerials) :	$f_M$ : External antenna (aerial) 300/75 ohms AM : Ferrite core antenna (aerial) or External antenna (aerial)
FM frequency response :	20 Hz to 15 kHz ( $\pm$ 1.5 dB)

**HA-M1 (STEREO AMPLIFIER)**

**GENERAL SPECIFICATION**

Semi-conductor :	IC's : 5 Transistors : 2 LED's : 11 Diodes : 2
Power supply :	AC : 100 to 120V or 200 to 240V 50/60 Hz DC : 12V (use car battery)
Dimensions (H×W×D) :	7.4 (include the foot)×23.0×16.0cm
Weight :	2.7kg

**AMPLIFIER SECTION**

Output power :

Both channel driven

15W×2 (4 ohms THD 5% 1 kHz) RMS

18W×2 (4 ohms THD 5% 1 kHz) music power

One channel driven

18W (4 ohms THD 5% 1 kHz)

20 Hz to 20 kHz (THD 0.8%±1.5 dB)

Frequency response :

0.2%

Harmonic distortion :

Damping factor :

30

Signal to Noise ratio :

FM mono : 65 dB

FM stereo : 60 dB

Channel separation :

50 dB (1 kHz)

Tone control :

Bass : ±8 dB (at 100 Hz)

Treble : ±10 dB (at 10 kHz)

Balance control :

0 to 100%

Input sensitivity/impedance :

PHONO: 2.5mV, 47 kohms

AUX : 200mV, 47 kohms

MIC : 0.2mV, 1 kohms

Tape play : 600mV, 47 kohms

Output impedance :

Speaker : 4 ohms

Headphone : 8 to 400 ohms

**DISASSEMBLY**

**FT-M1 (STEREO TUNER)**

**1. Top case**

1) (1-1) 2 screws

2) (1-2) 6 screws

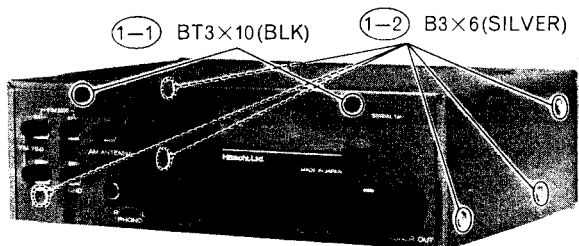

**2. Front panel**

1) Top case (See item 1)

2) (1) 1 Knob

3) (2-1) 2 screws

4) (2-2) 2 screws

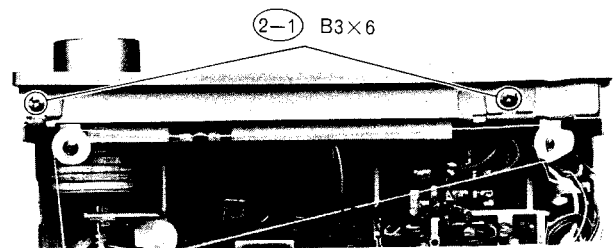

# M-1 (FT-M1, HA-M1) (W)

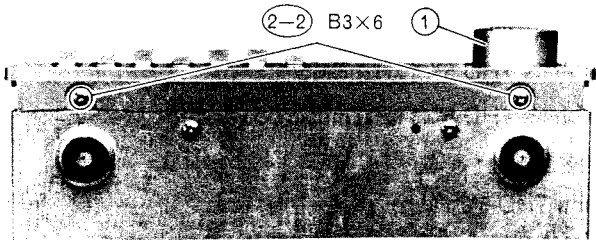

## HA-M1 (STEREO AMPLIFIER)

### 1. Top case

- 1) (1-1) 2 screws
- 2) (1-2) 6 screws

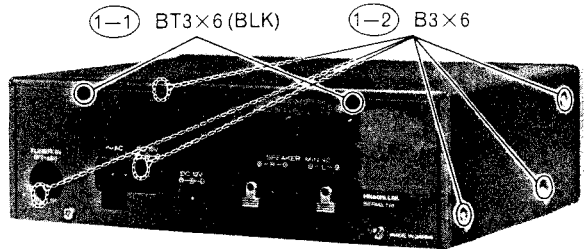

### 3. Back cover

- 1) Top case (See item 1)
- 2) (3) 2 screws

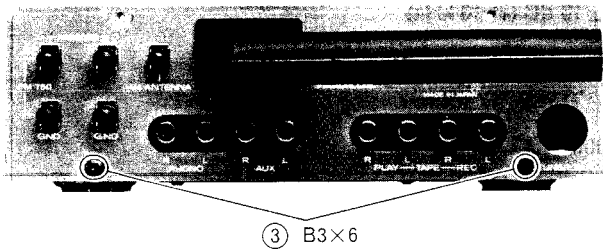

### 2. Front panel

- 1) Top case (See item 1)
- 2) (2-1) 1 screw
- 3) (2-2) 1 screw
- 4) 2 stoppers
- 5) (2) 5 Knobs

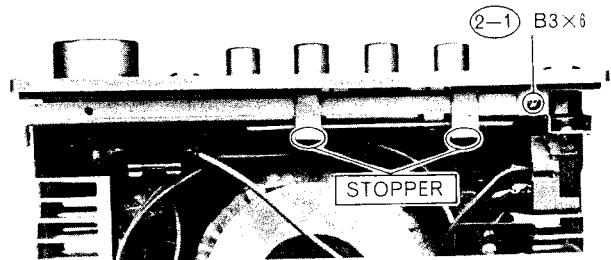

### 4. Bottom cover

- 1) Back cover (See item 3)
- 2) (4-1) 2 screws
- 3) (4-2) 1 screw

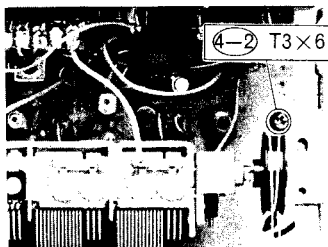
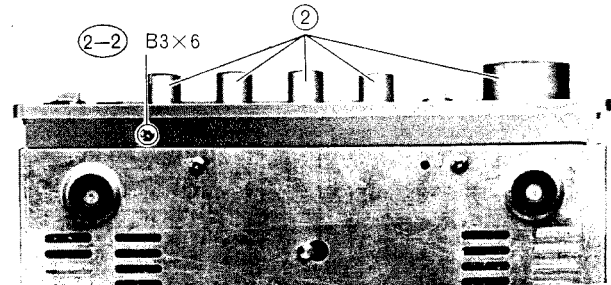
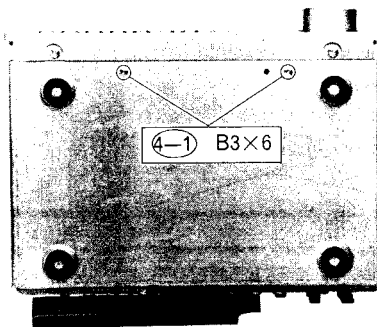

**3. Back cover**

- 1) Top case (See item 1)
- 2) (3-1) 2 screws
- 3) (3-2) 2 screws

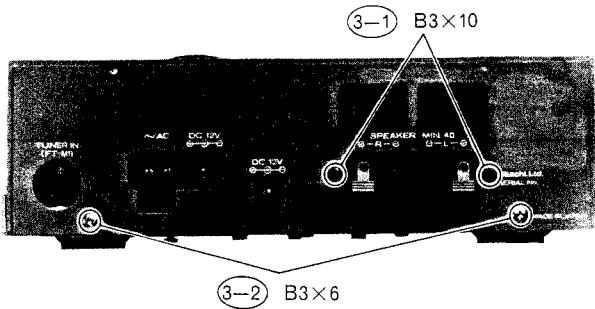

**4. Power transformer**

- 1) Top case (See item 1)
- 2) (4) 1 screw
- 3) Turn the power transformer in the direction of arrow.

**5. Bottom cover**

- 1) Power transformer (See item 4)
- 2) (5-1) 2 screws
- 3) (5-2) 2 screws

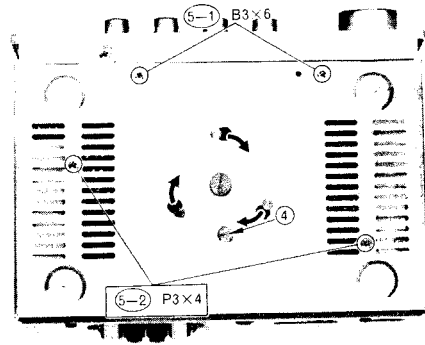

**DIAL CORD STRINGING**

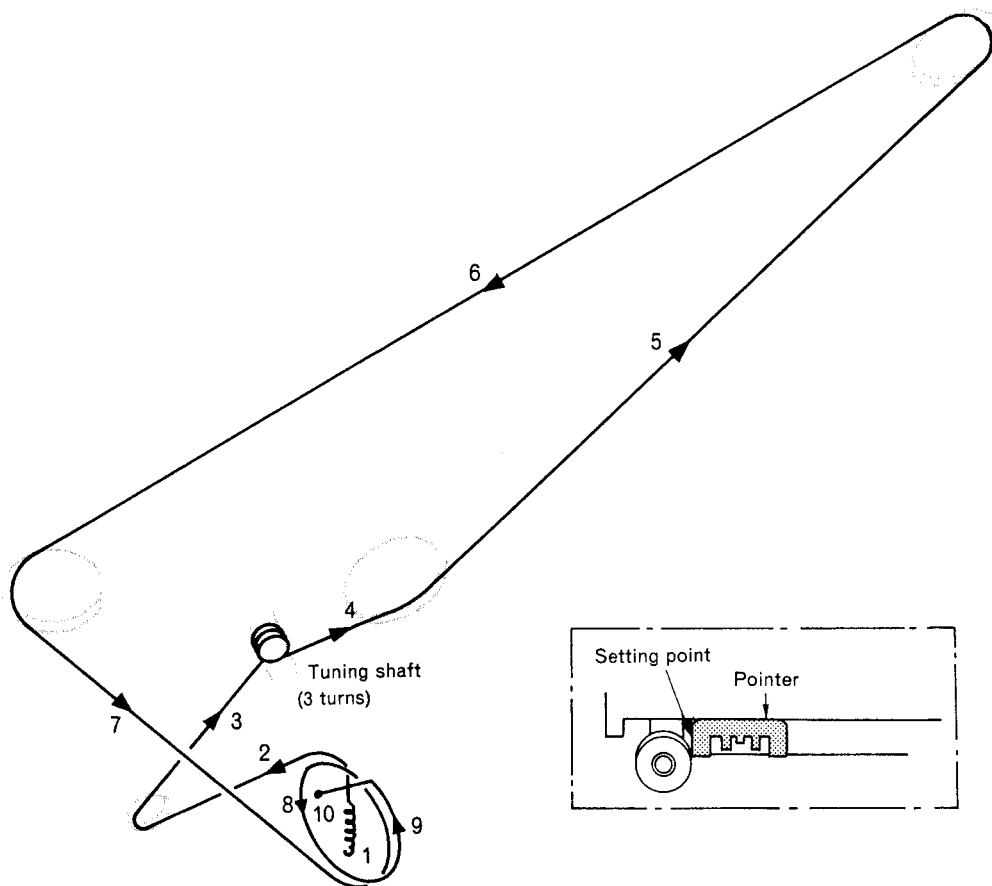

**STRINGING METHOD**

1. Turn the pulley fully counterclockwise.
2. String the dial cord in the direction of arrow (No. 1~10).
3. Set the pointer to setting position.

### ADJUSTMENT

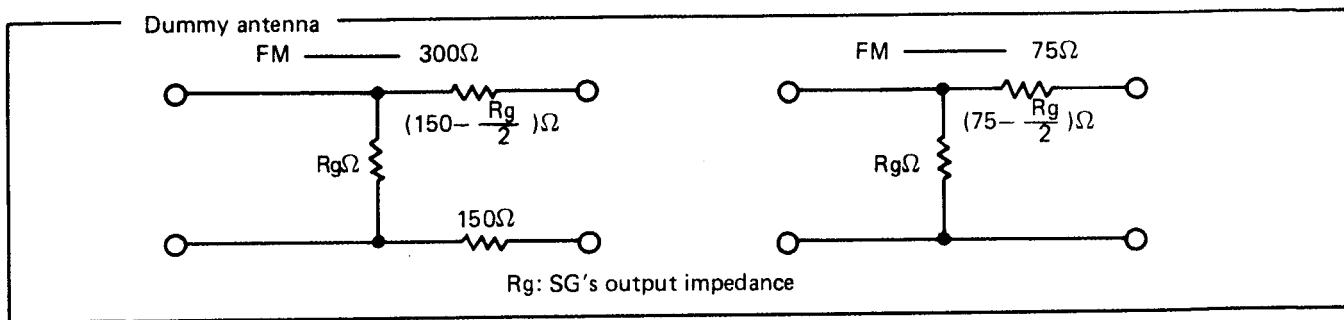

#### 1. FM IF adjustment

**Setting :**

- FM switch : On
- Mode switch : Mono

**Connection :**

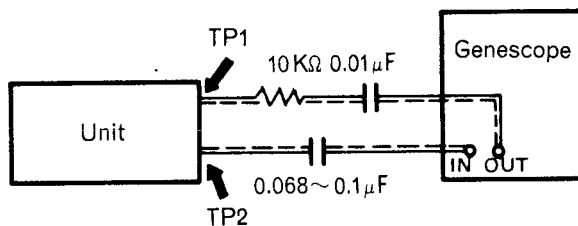

**Adjustment :**

Genescope	Dial pointer position	Adjust	Reading	Remarks
10.7 MHz	Highest	T202	—	Turn the T202 fully counterclockwise.
		T103 T201	Maximum 	1) fc: Specified center frequency of the ceramic filter. 2) Reduce the level of the genescope so that the waveform will be one.
		T202		Adjust the T202 so that the output is like the S curve for symmetrical sinewave.

#### 2. FM RF (Covering & Tracking) adjustment

**Setting :**

- FM switch : On
- Mode switch : Mono

**Connection :**

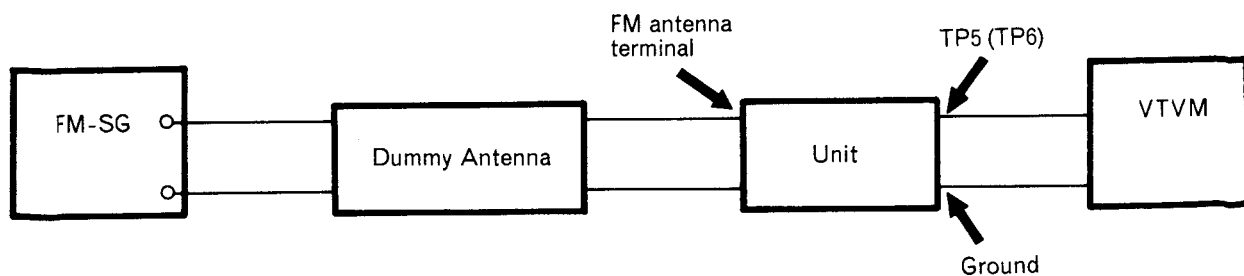

**Adjustment :**

Item	Signal generator		Dial pointer position	Adjust	Reading	Remarks
	Frequency	Modulation				
1	Covering	87.25 MHz	400 Hz 30%	Lowest	Max.	—
2		109 MHz		Highest		
3	Repeat 1 and 2.					
4	Tracking	90 MHz	400 Hz 30%	90 MHz	Max.	
5		106 MHz		106 MHz		
6	Repeat 4 and 5.					

**3. AM IF adjustment**

**Setting :**

- AM switch : On

**Connection :**

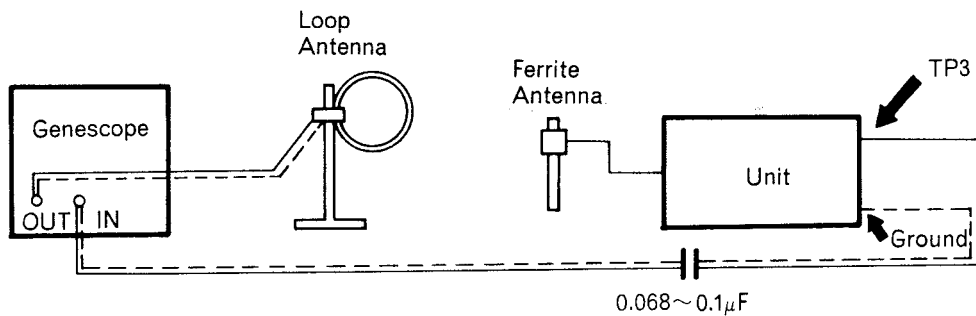

**Adjustment :**

Genescope		Dial pointer position	Adjust	Reading	Remarks
Frequency	Modulation				
455 kHz	—	Highest	T153, T203	Max.	—

**4. AM RF (Covering & Tracking) adjustment**

**Setting :**

- AM switch : On

**Connection :**

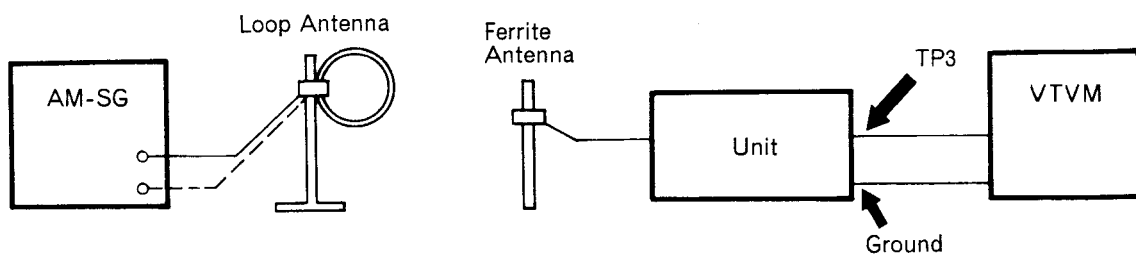

**Adjustment :**

Item	Signal generator		Dial pointer position	Adjust	Reading	Remarks
	Frequency	Modulation				
1	Covering	515 kHz	400 Hz 30%	Lowest	T152	—
2		1650 kHz		Highest	CT152	
3	Repeat 1 and 2.					
4	Tracking	600 kHz	400 Hz 30%	600 kHz	T151	Max.
5		1400 kHz		1400 kHz	CT151	
6	Repeat 4 and 5.					

**5. FM MPX (Multiplex) adjustment**

**Setting :**

- FM switch : On
- Mode switch : Stereo

**Connection :**

Connect a 10 $\mu$ F 25V electrolytic capacitor between the No. 2 pin of IC301 and ground.

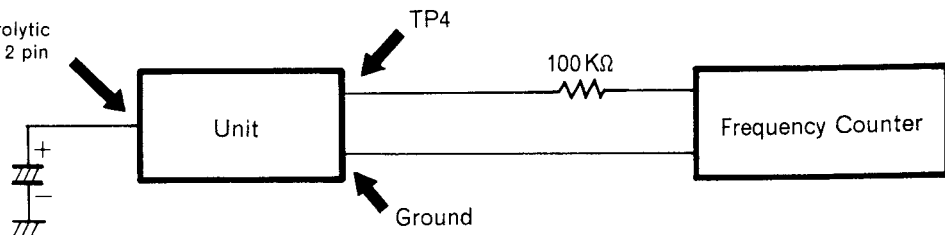

**Adjustment :**

Adjust	Reading	Remarks
RT302	19 kHz $\pm$ 100 Hz	—

**6. FM separation adjustment**

**Setting :**

- Mode switch : Stereo
- FM switch : On

**Connection :**

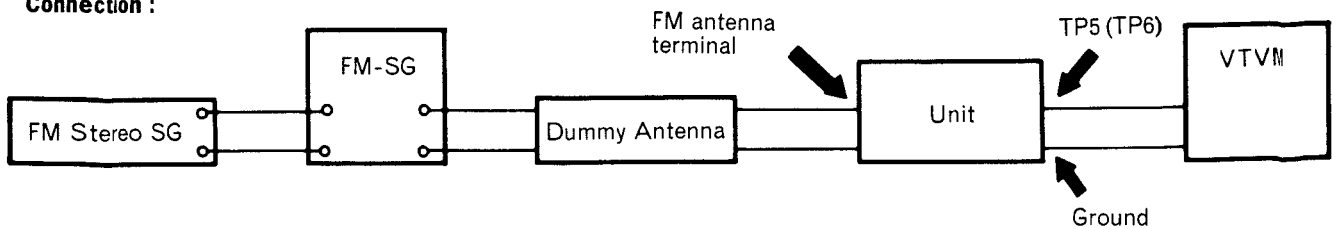

**Adjustment :**

Signal generator		Dial pointer position	Adjust	Reading	Remarks
Frequency	Modulation				
98 MHz 60 dB	L+R (1 kHz) : 40 kHz dev. Pilot (19 kHz) : 6 kHz dev.	98 MHz	RT301	Min.	1) After feeding in of R channel and pilot signals, adjust RT301 for a minimum L channel output. 2) Optimize RT301 so that the leak level of the L channel signal is equal to that of the R channel signal.



### Adjustment Parts Location

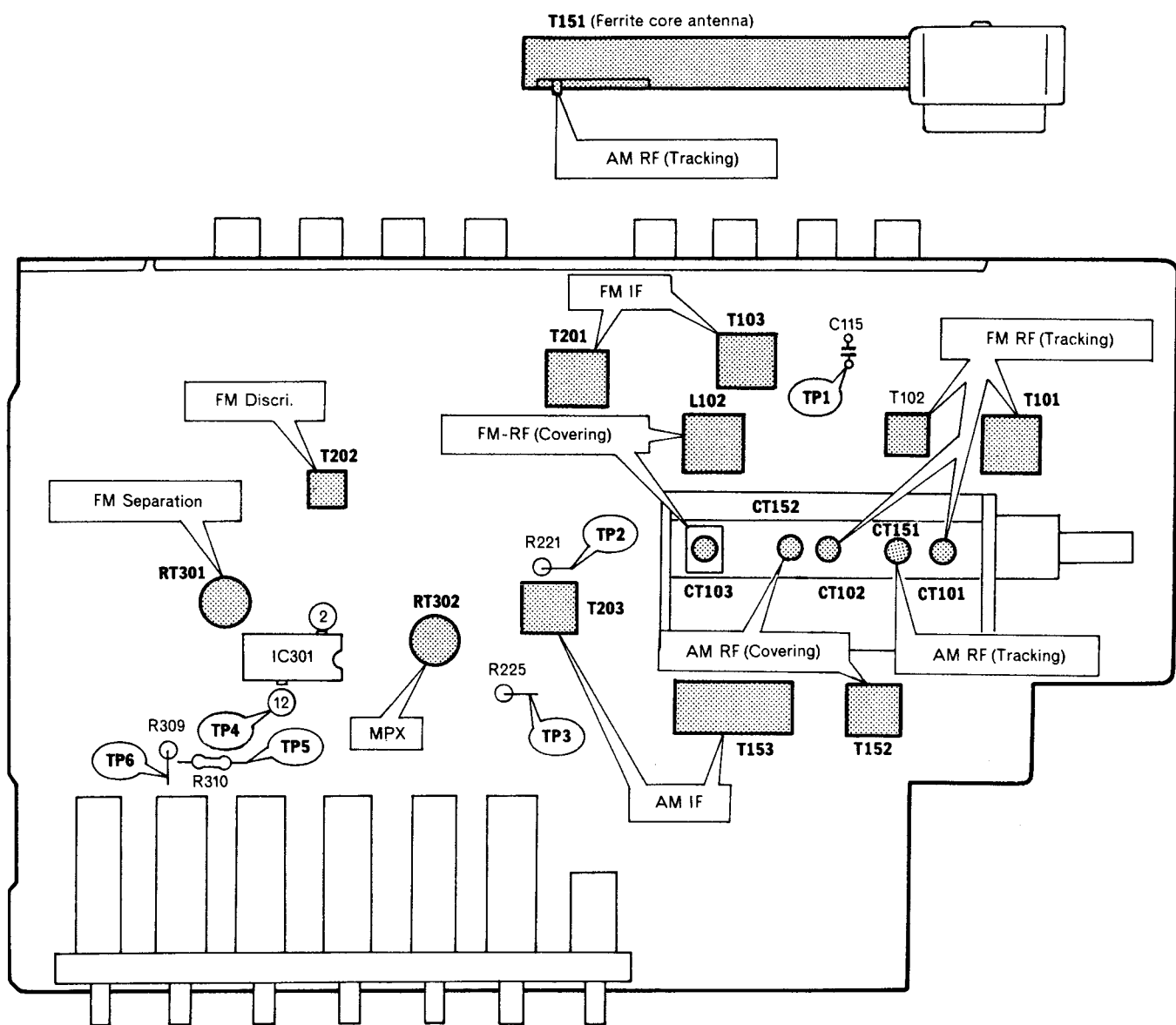

### BLOCK DIAGRAM

#### FT-M1 (STEREO TUNER)

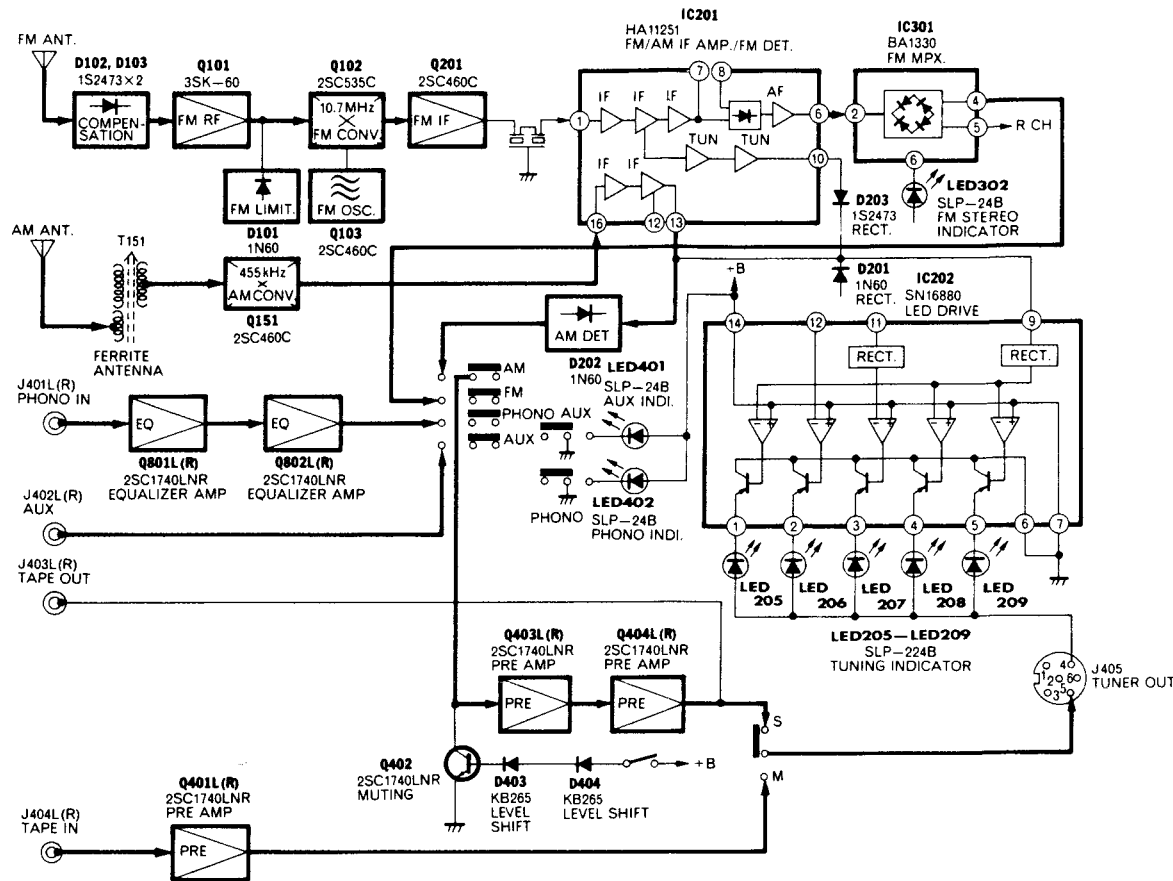

#### HA-M1 (STEREO AMPLIFIER)

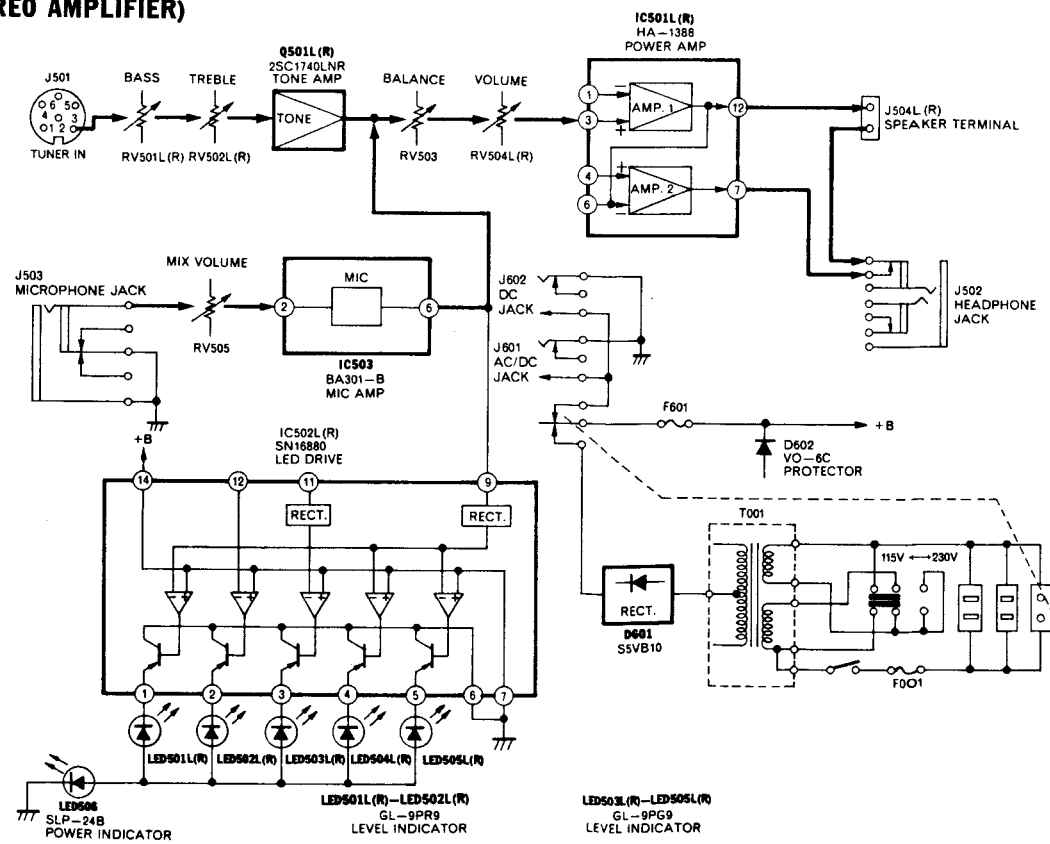

### SCHEMATIC DIAGRAM (FT-MI)

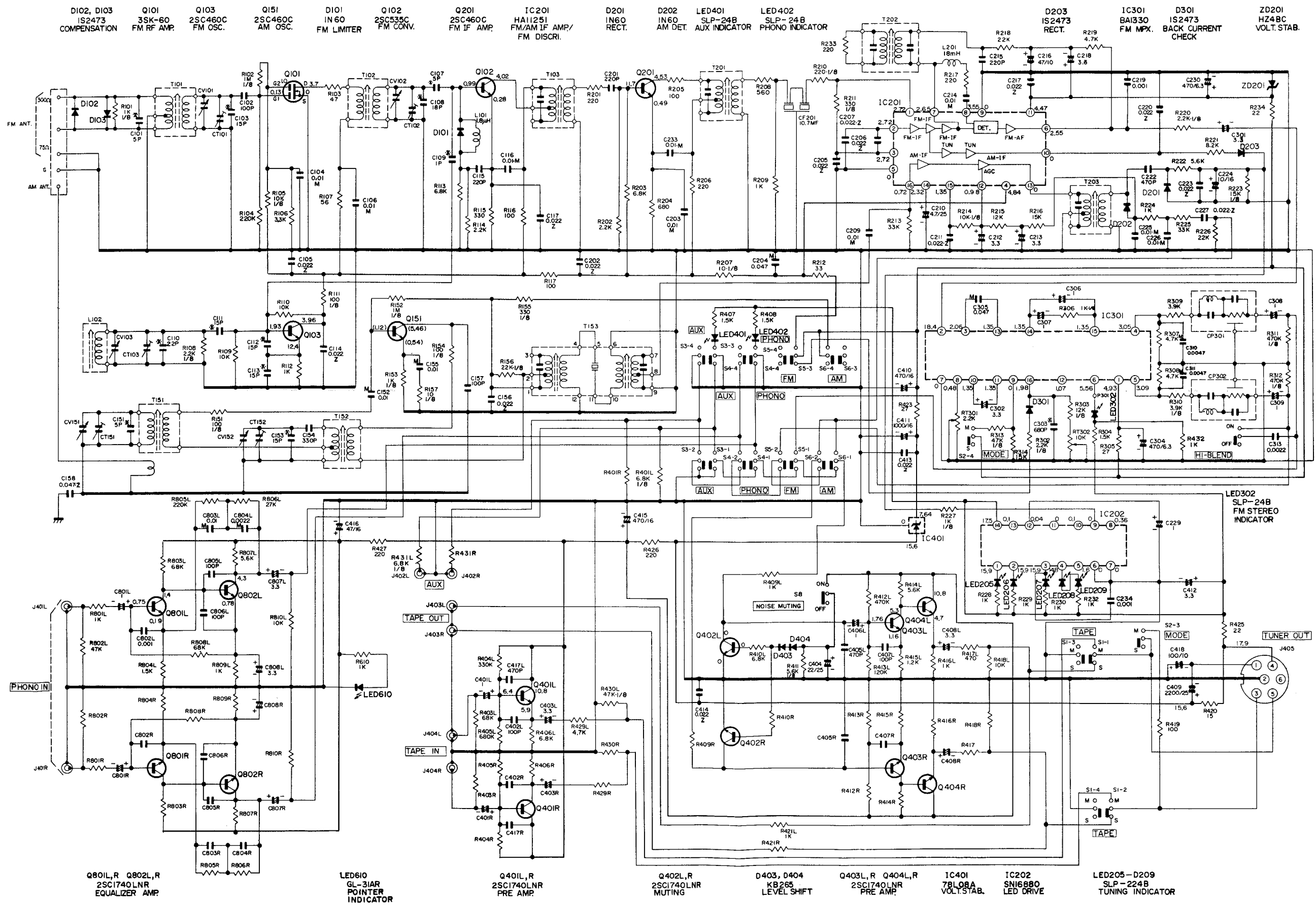

CIRCUIT BOARD DIAGRAM (FT-M1)

Ground : Signal, + B

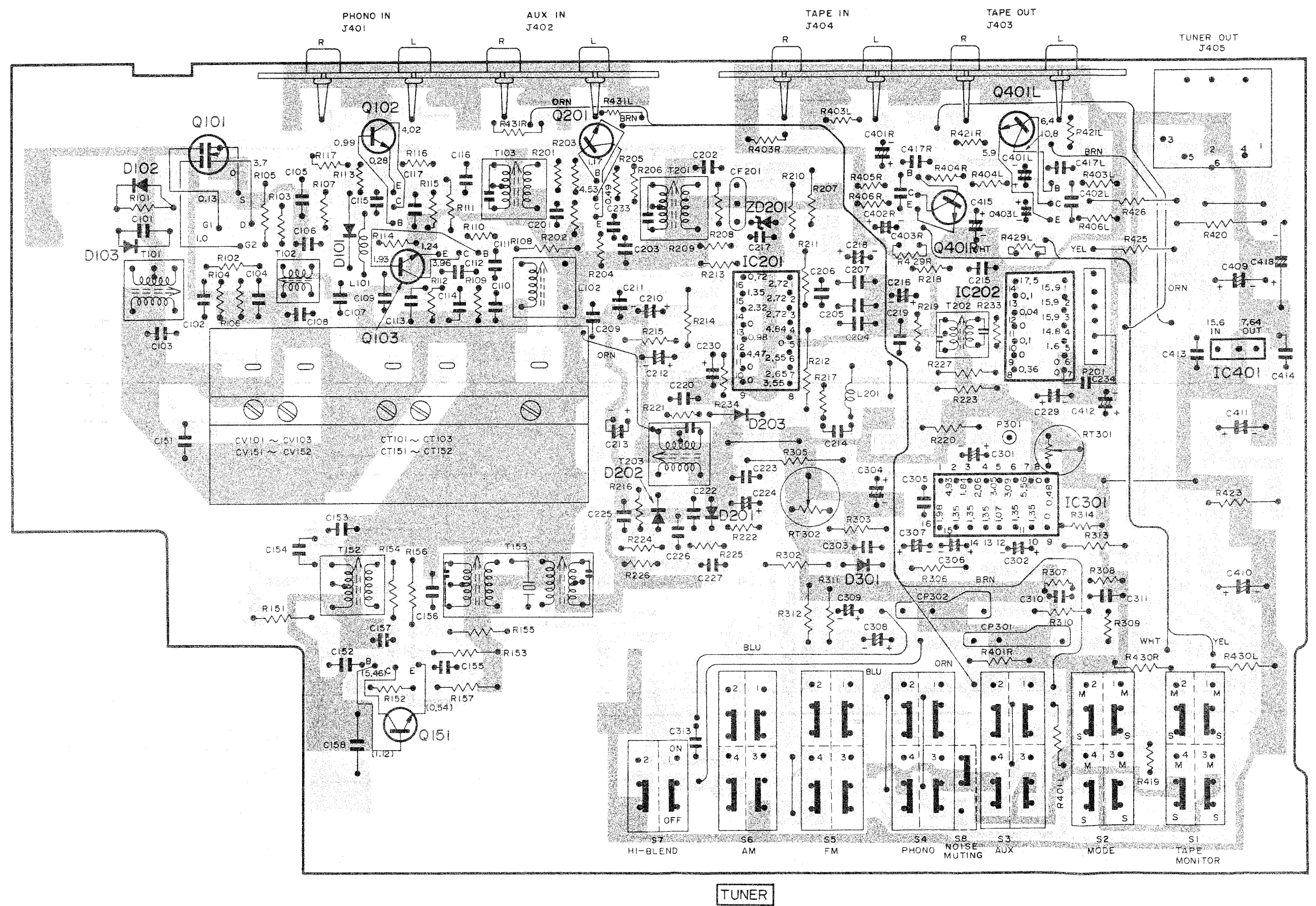

WIRING DIAGRAM (FT-MI)

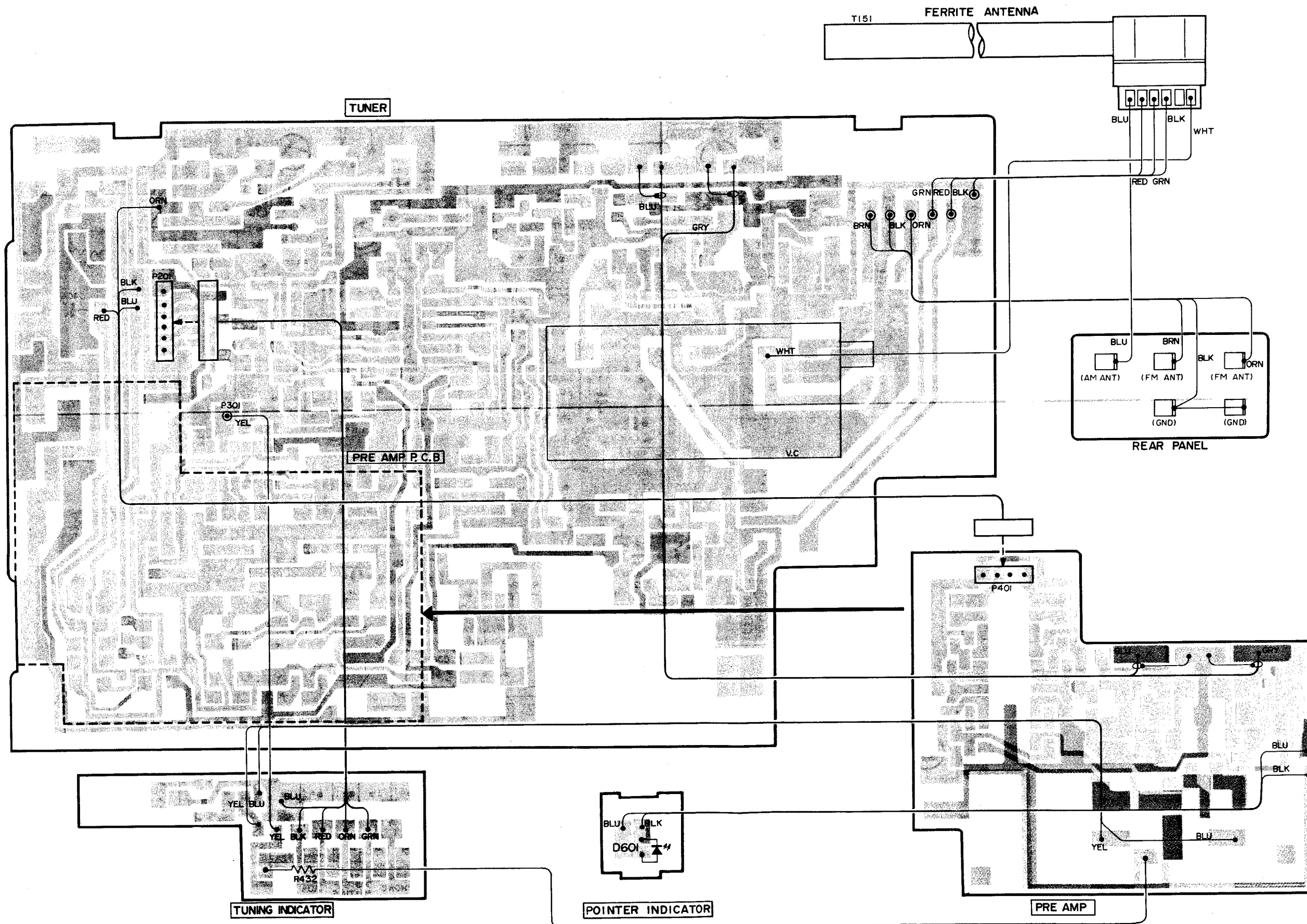

WIRING DIAGRAM (HA-MI)

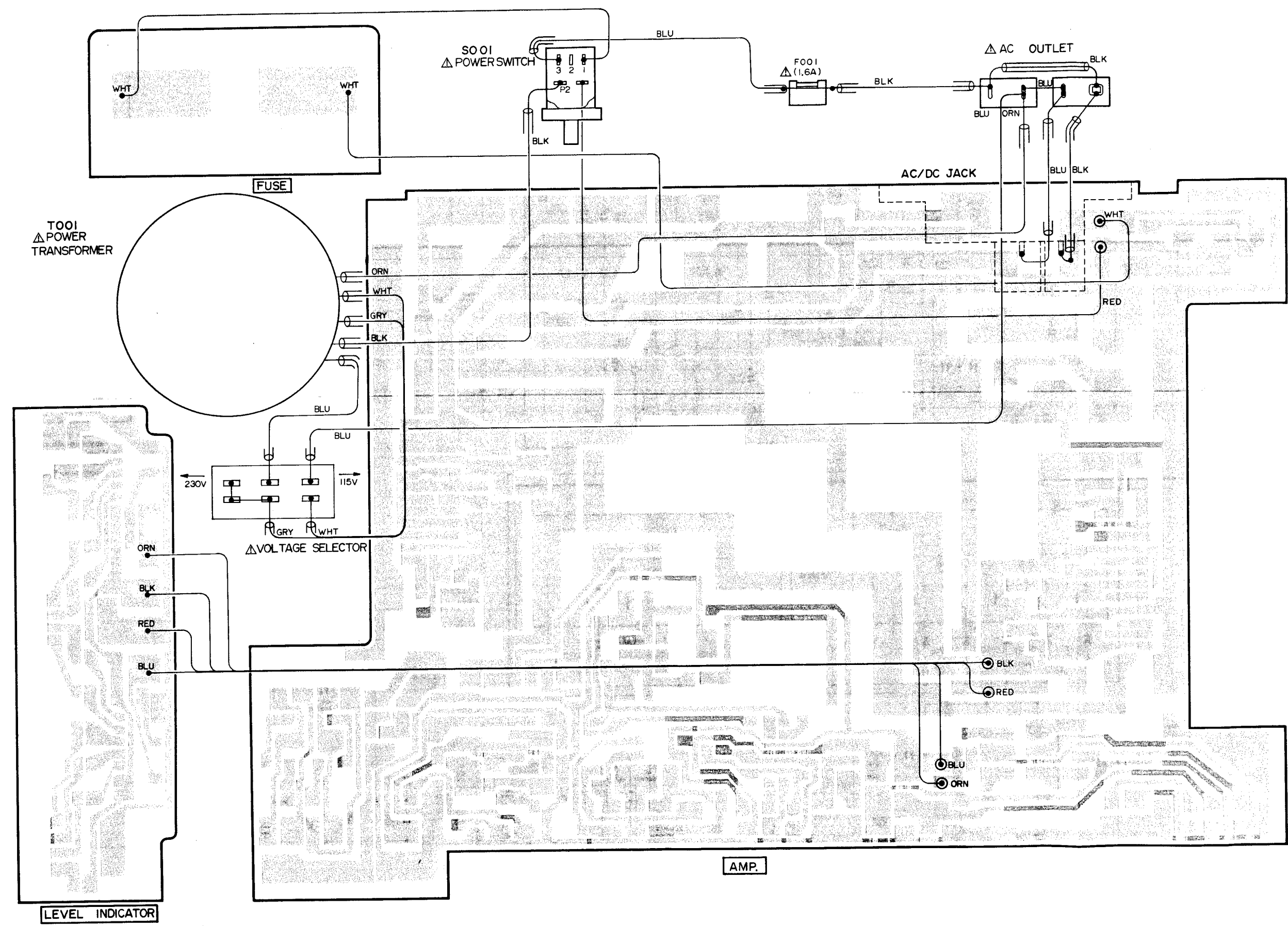

**SCHEMATIC DIAGRAM (HA-M1)**

Q501L, R  
2SC1740LNR  
TONE AMP

IC501L, R  
HA1388  
POWER AMP

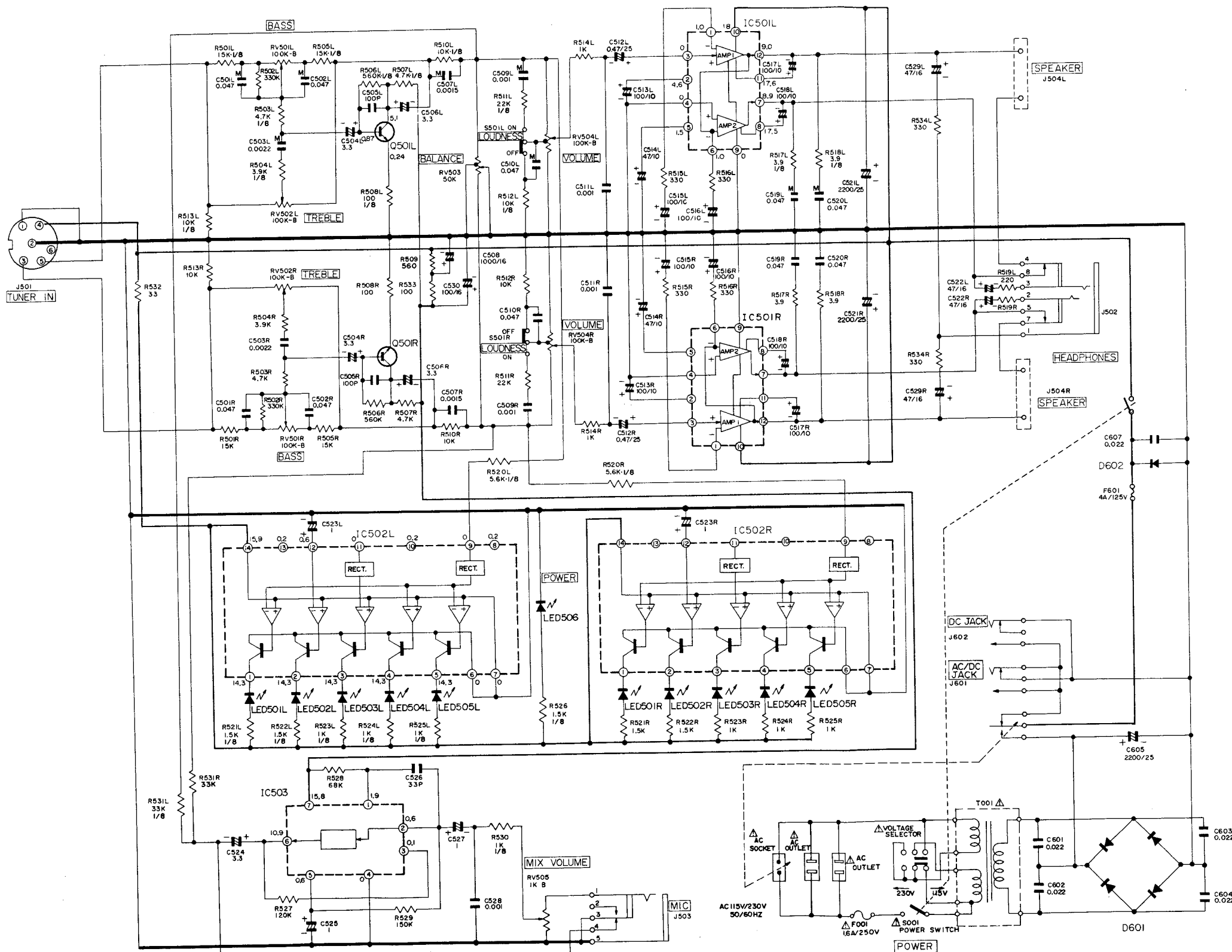

IC502L, R  
SNI6880  
LED DRIVE

IC503  
BA301B  
MIC AMP.

LED506  
SLP-24B  
POWER INDICATOR

LED501L, R LED502L, R LED503L, R LED504L, R LED505L, R  
GL-9PR9  
LEVEL INDICATOR

D601  
S5VBIO  
RECT.

D602  
VO-6C  
PROTECTOR

**Note**

1. Voltage measured at base of chassis with minimum volume control and no signal.
2. Nomenclature of Resistors and Capacitors.

Circuit No.	
Value	No indicated Ω (Ohm) M : 1000 kΩ
Tolerance	No indicated ±5% K : ±10% M : ±20%
Wattage	No indicated ¼W
Sort	No indicated Carbon film RC : Composition RW : Wire wound RS : Oxide metal film RN : Fixed metal film

Circuit No.	
Value	No indicated μF P : PF
Tolerance	No indicated ±10% J : ± 5% M : ±20% Z : +80%, -20% D : ±0.5pF C : ±0.25pF
Sort	Ceramic Electrolytic Mylar Polyester Styrol
Voltage	No indicated 50WV

3. Be sure to make your orders of resistors and capacitors with value, voltage, tolerance and sort.
4. When replacing capacitors marked with \*, use specified ones stated on parts list since required temperature characteristics.

CIRCUIT BOARD DIAGRAM (HA-M1)

Ground : Signal, +B

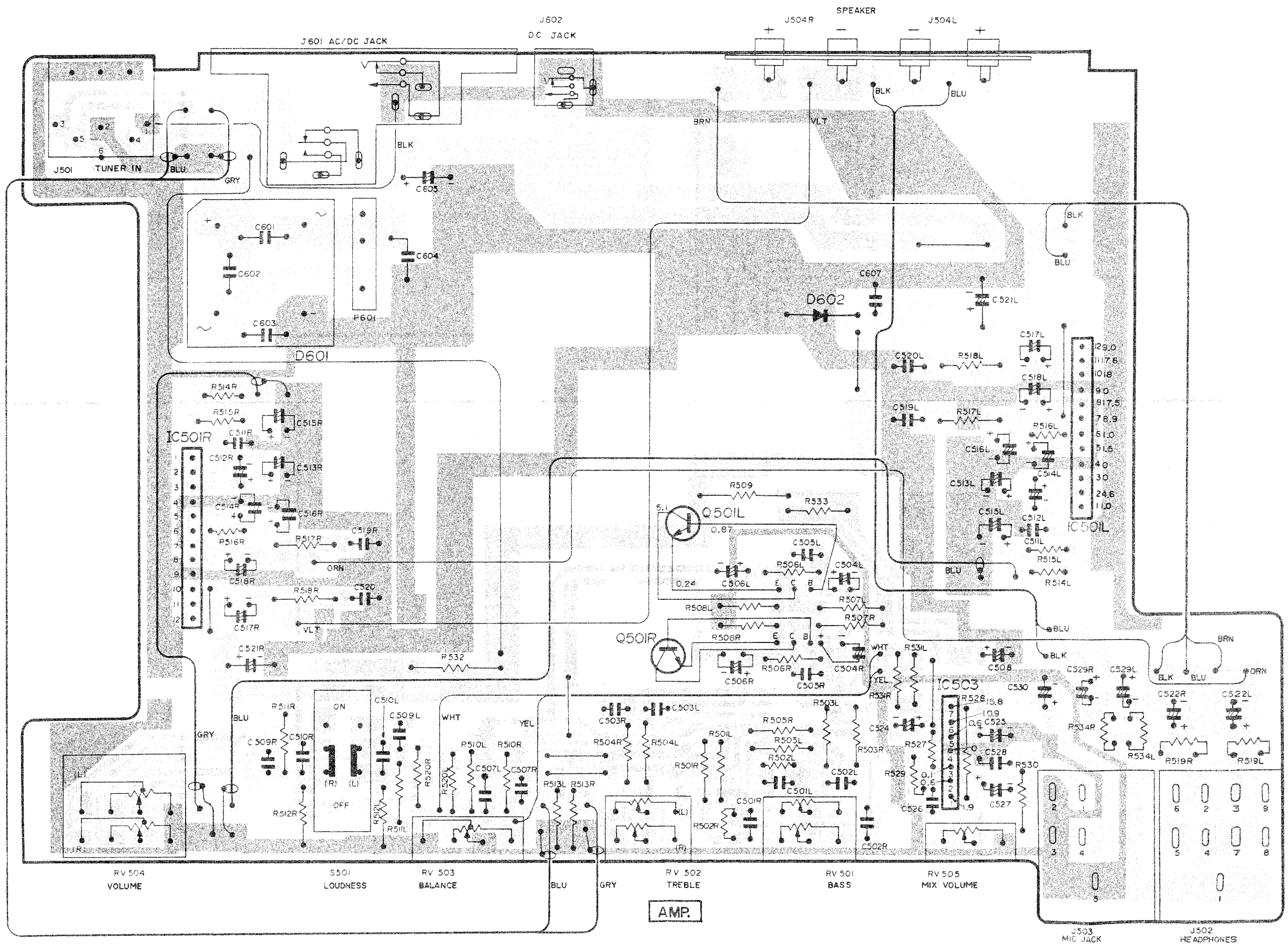

CIRCUIT BOARD DIAGRAM (FT-M1/HA-M1)

Ground

Signal, +B

Component side pattern

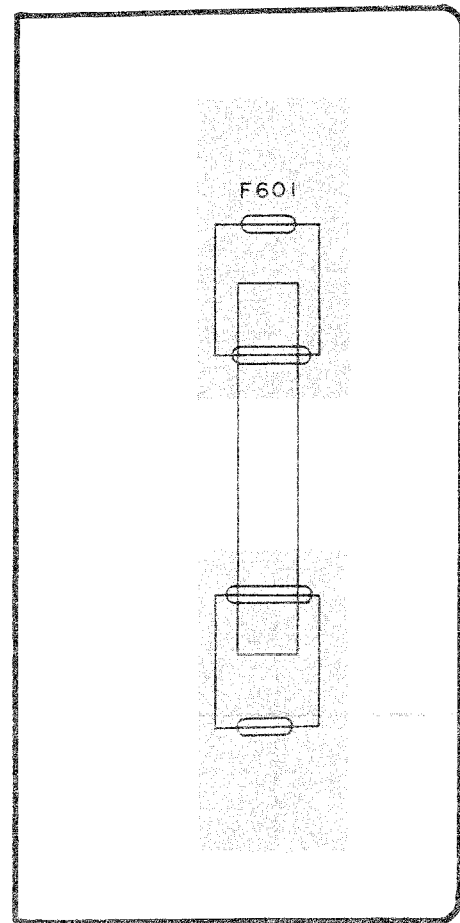

FUSE

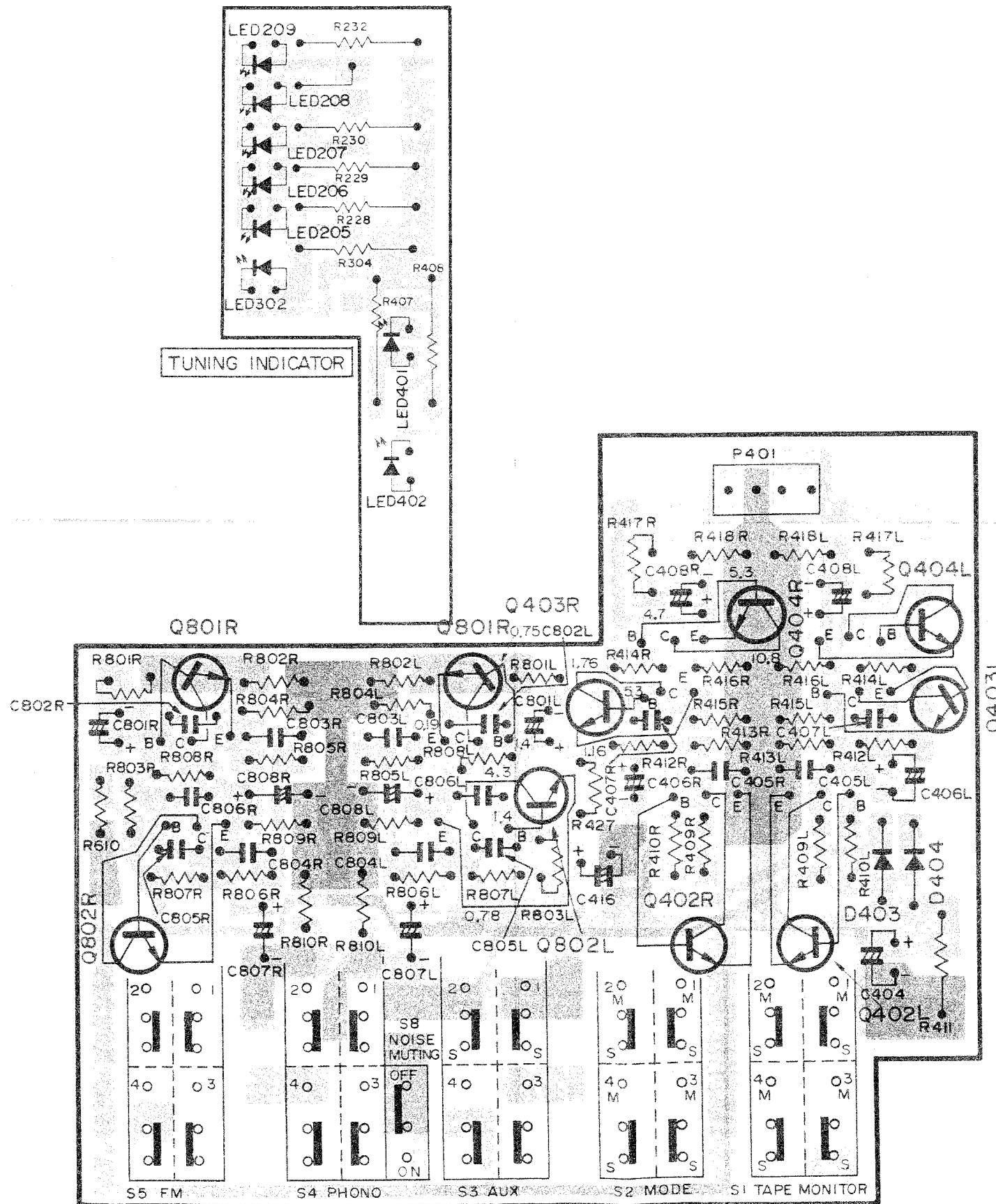

PRE AMP

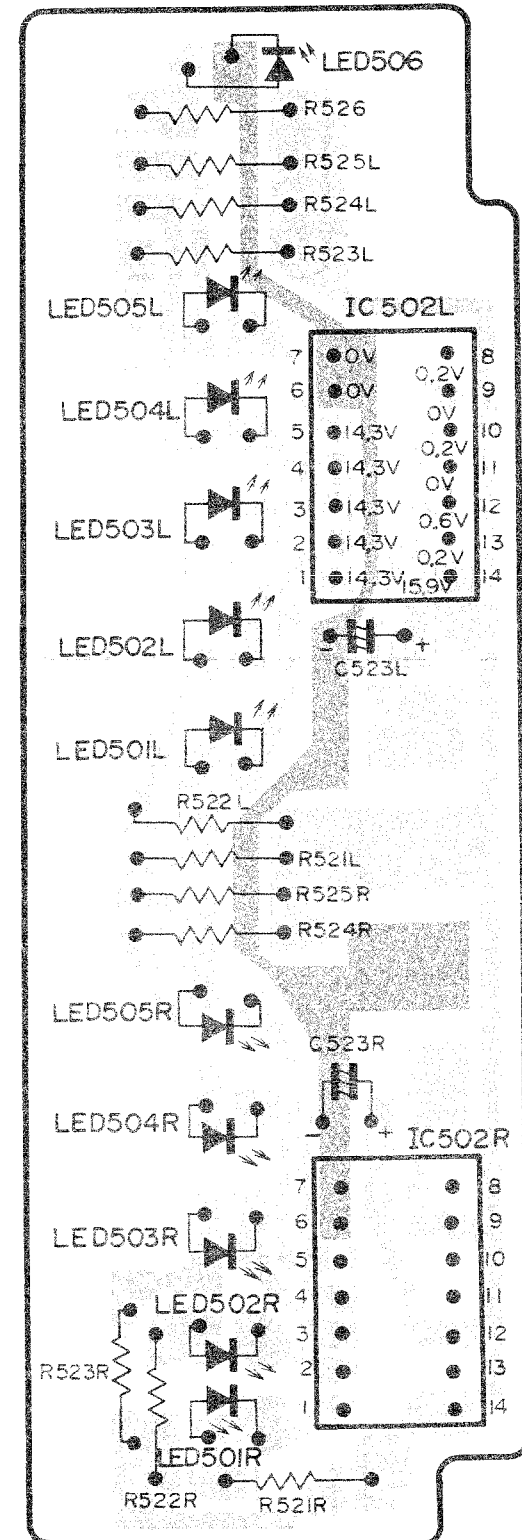

LEVEL INDICATOR



## REPLACEMENT PARTS LIST

SYMBOL-NO	P-NO	DESCRIPTION	SYMBOL-NO	P-NO	DESCRIPTION
CAPACITORS			1C401	5359332	IC 78L08A
C101	0246425	CERAMIC DISC 5P-D	1C501LR	5352071	IC HA1388
C103	0246474	CERAMIC DISC 15PF+-10%(NP-0)	1C502LR	5350761	IC SN16880
C107	0246425	CERAMIC DISC 5P-D	1C503	5350271	IC BA301B
C108	0246476	CERAMIC DISC 18PF+-10%	Q101	5322151	TRANSISTOR 3SK60
C109	0246421	CERAMIC DISC 1PF+-0.5PF (NP-0)	Q102	0573511	TRANSISTOR SILICON 2SC535 700M
C110	0248218	CERAMIC DISC 22PF	Q103	0573487	TRANSISTOR 2SC460C
C111	0246474	CERAMIC DISC 15PF+-10%(NP-0)	Q151	0573487	TRANSISTOR 2SC460C
C112	0246474	CERAMIC DISC 15PF+-10%(NP-0)	Q201	0573487	TRANSISTOR 2SC460C
C113	0246474	CERAMIC DISC 15PF+-10%(NP-0)	Q401LR	5321293	TRANSISTOR 2SC1740LN-R
C151	0246425	CERAMIC DISC 5P-D	Q402LR	5321293	TRANSISTOR 2SC1740LN-R
C153	0246474	CERAMIC DISC 15PF+-10%(NP-0)	Q403LR	5321293	TRANSISTOR 2SC1740LN-R
C303	0221331	POLYSTYROL FILM 680PF	Q404LR	5321293	TRANSISTOR 2SC1740LN-R
VC101	5050011	VARIABLE	Q501LR	5321293	TRANSISTOR 2SC1740LN-R
RESISTORS			Q801LR	5321293	TRANSISTOR 2SC1740LN-R
RT301	5007184	SEMI VARIABLE 2.2K OHM	Q802LR	5321293	TRANSISTOR 2SC1740LN-R
RT302	5007186	SEMI VARIABLE 10K OHM	ZD201	5330711	ZENER DIODE HZ4BC
RV501LR	5000046	VARIABLE 100K OHM(B)	TRANSFORMERS		
RV502LR	5000046	VARIABLE 100K OHM(B)	△ T001	5212673	POWER
RV503	5000284	VARIABLE 50K OHM (B)	T101	5123558	FM ANTENNA
RV504LR	5000515	VARIABLE 100K OHM(B)	T102	5126485	FM RF
RV505	5000118	VARIABLE 10 OHM(B)	T103	0329606	FM IF
SEMI-CONDUCTORS			T151	5113411	FERRITE ANTENNA
D101	5330731	DIODE GERMANIUM IN60 80MHZ 50MW	T152	5120461	AM OSCILLATOR COIL
D102	5330573	DIODE SILICON 1S2473 300MHZ 300MW	T153	5160021	AM IF
D103	5330573	DIODE SILICON 1S2473 300MHZ 300MW	T201	0329606	FM IF
D201	0575005	DIODE GERMANIUM IN60 80M	T202	5140017	FM IF
D202	0575005	DIODE GERMANIUM IN60 80M	T203	0322118	AM IF 20K OHM:10K OHM
D203	5330573	DIODE SILICON 1S2473 300MHZ 300MW	COILS		
LED205-209	5380111	RADIATION DIODE SLP-224B	L101	5152064	CHOKE 1.8MICRO H
D301	5330573	DIODE SILICON 1S2473 300MHZ 300MW	L102	5123355	FM OSCILLATOR
LED302	5380101	RADIATION DIODE SLP-24B	L201	5150821	CHOKE 18MICRO H
LED401	5380101	RADIATION DIODE SLP-24B	MISCELLANEOUS		
LED402	5380101	RADIATION DIODE SLP-24B	△	5620544	SLIDE SWITCH (VOLTAGE SELECTOR)
D403	5340161	VARIATOR KB265	△	5652193	AC OUTLET
D404	5340161	VARIATOR KB265	CF201	5160241	CERAMIC FILTER 10.7MF
LED501LR	5380391	LED GL-9PR9	CP301	5161731	LCR FILTER
LED502LR	5380391	LED GL-9PR9	CP302	5161731	LCR FILTER
LED503LR	5380392	LED GL-9PG9	△ F001	5721061	FUSE 1.6A
LED504LR	5380392	LED GL-9PG9	F601	5720263	FUSE 4A
LED505LR	5380392	LED GL-9PG9	J401LR	5676082	PIN JACK
LED506	5380101	RADIATION DIODE SLP-24B	J402LR	5676082	PIN JACK
D601	5330831	DIODE S5VB10	J403LR	5676082	PIN JACK
D602	5330101	DIODE SILICON V06C 15K	J404LR	5676082	PIN JACK
LED610	5380041	LED GL-31AR	J405	5677081	6P DIN SOCKET
IC201	5351411	IC HA11251	J501	5677081	6P DIN SOCKET
IC202	5350761	IC SN16880	J502	5674083	HEADPHONE JACK
IC301	5350684	IC HA1330	J503	5674141	MIC JACK

**M-1 (FT-M1, HA-M1) (W)**

SYMBOL-NO	P-NO	DESCRIPTION	SYMBOL-NO	P-NO	DESCRIPTION
MISCELLANEOUS					
J504LR	5687351	4P PUSH TERMINAL	6222792		FRONT PANEL ASSEMBLY
△ J601	5652121	POWER SOCKET	6052041		PUSH BUTTON (LOUDNESS)
J602	5678061	DC JACK	6052042		PUSH BUTTON (POWER)
△ S001	5633271	POWER SWITCH	6222772		REAR PANEL
S1-S7	5634278	PUSH SWITCH (TAPE, MODE, AUX, PHONO, FM, AM, HI-BLEND)	6041335		UNDER COVER
S501LR	5634166	PUSH SWITCH (LOUDNESS)	6631941		DISPLAY METAL
FOR ACCESSORIES			MISCELLANEOUS (FT-M1)		
	5896541	DC PULG CORD	7740372		FELT LEG
△	5747214	POWER CORD	6222912		FRONT PANEL ASSEMBLY
	5896392	FM ANTENNA	6283222		KNOB ASSEMBLY-34MMD (TUNING)
	5896771	DIN CORD	6052041		PUSH BUTTON (TAPE, MODE, AUX, PHONO, FM, AM, HI-BLEND)
	5660212	SIEMENS PLUG	6041327		UPPER COVER
	5897422	CAR BATTERY CORD	8699410		BT BIND HEAD SCREW-3MMDX10MM (BLACK ) (FOR UPPER COVER FIXING)
MISCELLANEOUS (HA-M1)			6041332		UNDER COVER
	7740372	FELT LEG	6715061		ROLLER - 13MMD
	6283223	KNOB ASSEMBLY-34MMD (VOLUME)	7777603		SCREW (FOR ROLLER FIXING)
	6283212	KNOB ASSEMBLY-14MMD (MIX VOLUME, BASS, TREBLE, BALANCE)	6376251		FLYWHEEL ASSEMBLY
	6041328	UPPER COVER	6467622		SCALE PLATE
	8699410	BT BIND HEAD SCREW-3MMDX10MM (BLACK ) (FOR UPPER COVER FIXING)	6399902		POINTER
	7547791	SPECIAL SCREW (FOR POWER TRANSFORMER FIXING)	6345081		PULLEY
	7535187	LOCK LEVER PIN	6316233		SPRING M
			6222862		REAR PANEL
			7450912		TERMINAL PIECE



**HITACHI Ltd. TOKYO JAPAN**  
 Head Office : 5-1, 1-chome, Marunouchi, Chiyoda-ku, Tokyo  
 Tel. Tokyo (212) 1111 (80 lines)  
 Cable Address : "HITACHY" TOKYO  
 Codes : All Codes Used