

Service
Service
Service

Service Manual

12 V 

22SY686/23 (EUROPE)

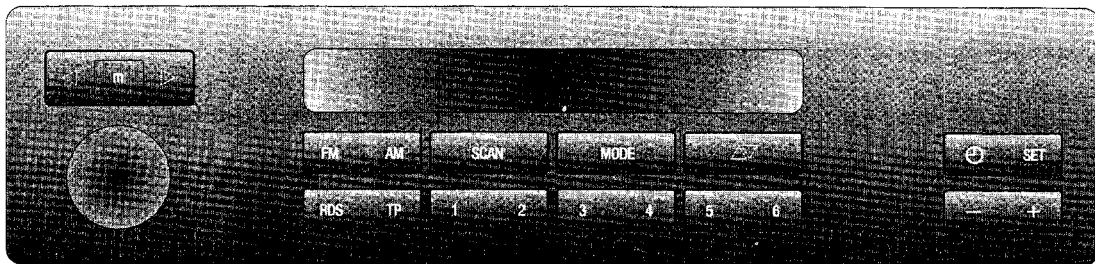

22SY686/23R (JAPAN)

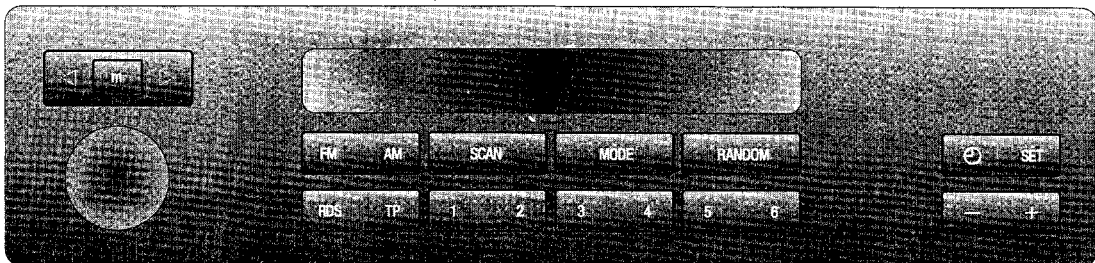

22SY686/23T (OCEANIA)

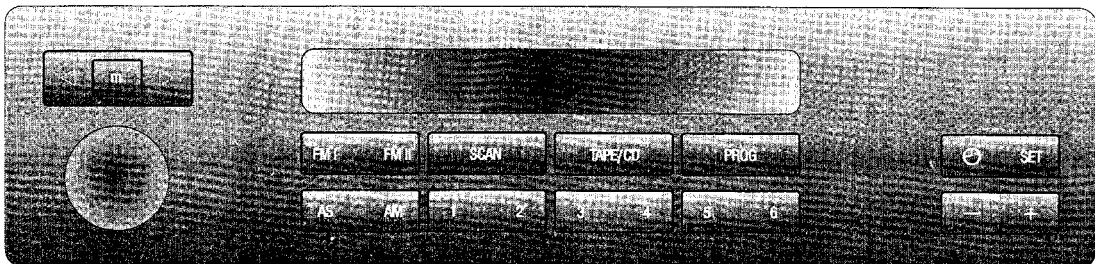

4821 725 23527



CONTENTS

Page 2	General, Technical data
Page 3	Connectorblock, Controls and Display
Page 4	Radio functions
Page 5	Cassette operation, CD-operation
Page 6	CD changer operation, C33 / CD33 functions, Clock functions
Page 7	Blockdiagram IRIS (Integrated Radio Information System)
Page 8, 9	Supply voltages and signals
Page 10	Testmode, Eeprom
Page 11	Switch PWB, LCD PWB
Page 12	Circuit: Switches and Display
Page 13	Main PWB
Page 14	Circuit: Main
Page 15	Exploded view, mechanical parts
Page 16	Electrical parts

GENERAL

The IRIS modul 22SY686 is the control- and display-unit for radio and clock in the car. It does not work standalone.

To run this modul you have to connect the I-BUS line to the radiomodul 22DC786 (BMW C33) or 22DC986 (BMW CD33). You have to pullup this I-BUS connection with a resistor of 2,2 K Ω to permanent +.

However you can run the testmodes without the I-BUS connection (see chapter Testmode)

IRIS is also designed to control BMW carradios from other sources with possibly other functions as described in this Service Manual.

TECHNICAL DATA

POWER SUPPLY	Voltage range:	6 V – 16 V
	Quiescent current:	< 1 mA
	Current consumption when activ, incl. illumination:	< 700 mA
DATA COMMUNICATION	Intern (MCU – EEPROM)	I ² C
	Extern (IRIS – CAR)	I-BUS
MCU (P89CE558EFB)	8 Bit controller – 11,059 Mhz	
	32 KB ROM	
	1 KB RAM	
	I ² C interface	
	UART interface	
	2 PWM pins	
	8 channel 10 Bit A/D converter	
EEPROM	ST24C02AM6-013TR, 256 Bytes	
DISPLAY	Full dot matrix, 65 x 7 segments	
	5 symbols with 5 x 7 segments each	
	1 colon	
	15 fixed symbols	
	U _{DISPLAY} = 6,35 V (nom. at 25°C)	

CONNECTORBLOCK

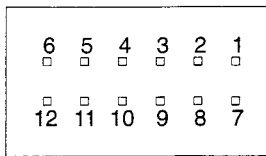

1 GND (31E)	7 NC
2 PERM.+ (30)	8 IGN.KEY (R)
3 EXT.ILL. (58G)	9 NC
4 DATA (I-BUS)	10 NC
5 NC	11 NC
6 NC	12 NC

CONTROLS

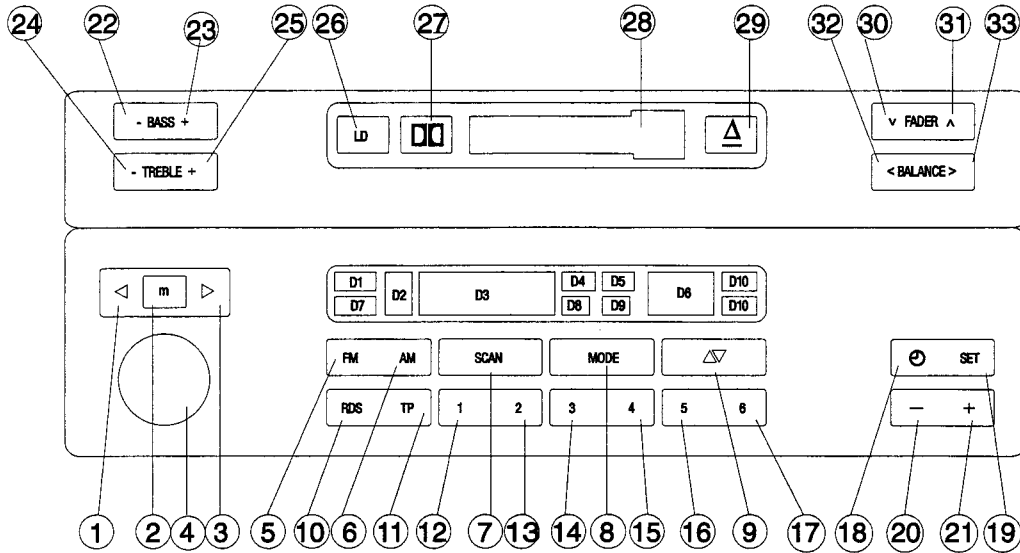

IRIS

- 1 Tuning button down
- 2 Manual Tuning
- 3 Tuning button up
- 4 On/Off and volume
- 5 Selection of waveband FM
- 6 Selection of waveband AM
- 7 Station scan, CD title scan (optional)
- 8 Mode switch
- 9 Track selection of Cassette Deck
- 10 Activation of RDS
- 11 Activation of Traffic Program
- 12-17 Preset buttons 1-6, CD selection (optional)
- 18 Request clock display
- 19 Activation of clock setting
- 20 Clock setting button down
- 21 Clock setting button up

C33 / CD33

- 22 Sound setting bass down
- 23 Sound setting bass up
- 24 Sound setting treble down
- 25 Sound setting treble up
- 26 Loudness on/off
- 27 Activation of Dolby
- 28 Cassette / CD compartment
- 29 Cassette / CD eject button
- 30 Sound setting rear
- 31 Sound setting front
- 32 Sound setting left
- 33 Sound setting right

DISPLAY

- D1 Indicator for of waveband, search levels, manual function
- D2 Display of selected preset button
- D3 Display of frequency, program name, cassette mode, CD number and track
- D4 Indicator for RDS
- D5 Indicator for Traffic Message Channel (currently not available)
- D6 Display of clock
- D7 Indicator for FM-Band Autostore
- D8 Indicator for traffic program
- D9 Indicator for 'Skip Blank' function (not available with C33 and CD33)
- D10 Indicator for AM/PM in 12-h clock format

RADIO FUNCTIONS

Mode choice

Stepping through the different modes can be achieved by repetitive pressing of the Mode button [8]:
Tuner mode → Cassette, resp. CD mode → CD changer mode (optional) → Tuner mode a.s.o.

Common hints to mode choice

If there is no medium (Cassette, CD-Magazine, CD) in the selected device or any malfunction is detected, the display [D3] shows an appropriate message:

- No cassette inserted: Message NO TAPE
- No CD inserted: Message NO DISC
- No magazine inserted into the changer: Message NO MAGAZINE
- No CD in the magazine: Message NO DISCS
- Faulty cassette: Message TAPE ERROR
- Faulty or wrongly inserted CD: Message CD ERROR
- Operation temperature exceeded: Message HIGH TEMP

In these cases the device stays in the currently selected mode.

Nevertheless, the momentary impossible mode can be skipped by pressing the Mode button [8] again.

Waveband choice

FM bands: tap FM button [5] FM I → FM II → FM AUTO

AM bands: tap AM button [6]: MW → LW → SW

Station selection by automatic search

Press one of the tuning buttons < or > [1 or 3].

First run – search level 1, [D1] shows “I”, second run – search level 2, [D1] shows “II”.

Manual choice of selectivity: Search for strong stations: Tap tuning button [1 or 3] once.
Search for weak stations: Tap tuning button [1 or 3] twice.

Station selection by manual search

Press button m [2], the “MAN” indicator [D1] is lit. Tap tuning buttons to tune the frequency.

Reception of a RDS station

Tap button RDS [10] to toggle between RDS on and off. Indicator [D4] shows status.

If a RDS station is received, the display [D3] first shows the frequency and afterwards the program service name.

Regionalization

Press button RDS [10] for about 2 sec. Display [D3] will briefly indicate status REG ON / REG OFF

Traffic program

Switch on/off by using TP button [11], [D8] indicates status.

Only stations providing traffic messages are received. The set automatically searches a TP station (“TP” blinking).

The Cassette- or CD-Operation will be interrupted during of a traffic message.

If a traffic program is received, but the TP-function is not activated, the indicator [D8] displays the character “T”.

Station storage manual

Press one of the preset buttons [12 – 17] about 2 sec. until the tuned station is audible again after a short mute.

Autostore

Keep FM button [5] pressed until display indicates “AUTOSTORE”.

The strongest FM stations are stored on the preset buttons [12 – 17] (waveband FM AUTO).

Recall of a stored station

Select waveband [5 or 6] and tap desired preset button [12 – 17].

Station scan

Tap SCAN button [7]. The frequency band is scanned upwards with selectivity level I.

If a station with sufficient strength is found, it gets audible for 8 seconds. Afterwards the searching is continued.

During the scan, the display [D3] toggles between the string “SCAN” and the frequency of the station.

The scan function can be aborted by pressing SCAN [7] again or by selection of any other radio function.

CASSETTE OPERATION (only C33)

Start cassette operation

Insert cassette into the compartment [28] **or** if there is already a cassette inside, tap the Mode-Button [8].

Stop cassette operation

Press eject button [29]. The cassette is ejected **or** if the cassette should stay inside, tap the Mode-Button [8].

Dolby noise reduction

With every tap on button [27] the function changes between "Dolby B", "Dolby C", "Off".

Track selection

With every press of button [9], playback toggles between track 1 (NOR) and track 2 (REV).

Fast winding

Tap button "m" [2] and then within 2 sec. tuning button [3] for fast forward winding or [1] for fast reverse winding. Stop winding by pressing button [1 or 3] again or by selection of another function.

Music search

Tap tuning button [1 or 3]. The tape winds to the begin of the next title, then the deck starts playback. Stop search by pressing button [1 or 3] again or by selection of another function.

Clean

After every 20 hours of cassette operation, the message "TAPE CLEAN" is displayed. Clean head and tape guidings with a wet cleaning cassette.

CD OPERATION (only CD33)

Start CD operation

Insert CD into the compartment [28] **or** if there is already a CD inside, tap the Mode-Button [8].

Stop CD operation

Press eject button [29], **or** if the CD should stay inside, press the Mode-Button [8].

If the CD is not removed from the player after eject, it is pulled in again automatically after a few seconds, but without changing to CD mode.

Cue and Review playback

First tap button "m" [2], then within 2 seconds press and hold tuning button [1 or 3] for fast playback.

After releasing the button, or when reaching the begin/end of the disc, the player resumes normal playback.

After 8 sec. the MANUAL function will automatically switch off.

Track up

Tap tuning button [3] to chose next track. If the button is held down, the track number is continuously incremented.

Track down

Tap tuning button [1] once to restart the current track.

Tap twice to chose previous track. If the button is held down, the track number is continuously decremented.

Scan search

Press SCAN button [7]. The tracks of the CD are played back for a few seconds in ascending order.

During the scan, the display [D3] toggles between the string "SCAN" and the number of the current track.

The scan function can be aborted by pressing "SCAN" [7] again or by selection of any other function.

Random playback

Keep button "SCAN" [7] pressed, until "RANDOM" appears. The tracks are played back in random order.

The display [D3] toggles between the string "RANDOM" and the number of the current track.

The random function can be aborted by pressing button [7] again or by selection of any other function.

CD CHANGER OPERATION (optional)

Start CD changer operation

Insert magazine into the CD changer **or** if there is already a magazine inside, tap the Mode-Button [8].

Stop CD changer operation

Press magazine eject button at the CD changer **or** if the magazine should stay inside, press the Mode-Button [8].

CD selection

Press button [12 – 17] to chose the desired CD. If there is no CD in the selected slot, "NO DISC" appears.

Cue playback, Track up/down, Scan search and Random playback

See the corresponding sections of the single CD operation.

C33/CD33 CONTROLS

Bass

Tap or keep pressed button [22] to decrease bass level and button [23] to increase bass level.

In the display, the current setting is indicated by the position of the vertical bar: BASS - ____|____ +

Treble

Tap or keep pressed button [24] to decrease treble level and button [25] to increase treble level.

In the display, the current setting is indicated by the position of the vertical bar: TREB - ____|____ +

Fader (front/rear)

Tap or keep pressed button [30] to increase the rear volume and button [31] to increase the front volume.

In the display, the current setting is indicated by the position of the vertical bar: FADR v ____|____ ^

Balance (left/right)

Tap or keep pressed button [32] to increase the left volume and button [33] to increase the right volume.

In the display, the current setting is indicated by the position of the vertical bar: BAL < ____|____ >

Loudness

Switch On/Off by tapping button [26].

Tone Linear

To adjust all tone settings to their central position, keep button [26] pressed until "TONE LINEAR" appears.

Volume adjustment

Adjust volume by turnknob [4].

CLOCK FUNCTIONS (only available when set is connected to the timer modul of the car or the I-BUS tool)

Request clock display

Tap button [18] to display the actual time for about 8 seconds (also possible with ignition off).

Clock setting

If power supply was interrupted the clock has to be set initially. This is indicated by a blinking clock display.

Press button "SET" [19], in the display [D6], the segments for the minutes are blinking.

Press or keep pressed one of the clock setting buttons [20, 21] to increment or decrement the minutes.

If the minutes are adjusted correctly, press button "SET" [19] again. The segments for the hours are blinking.

Press or keep pressed one of the clock setting buttons [20, 21] to increment or decrement the hours.

If the hours are adjusted correctly, press button "SET" [19] again to finish the setting.

Cancel setting procedure

The setting procedure can be cancelled at any time by pressing the clock request button [18]. In this case, all previous manipulations of the clock are disregarded.

Blockdiagram IRIS

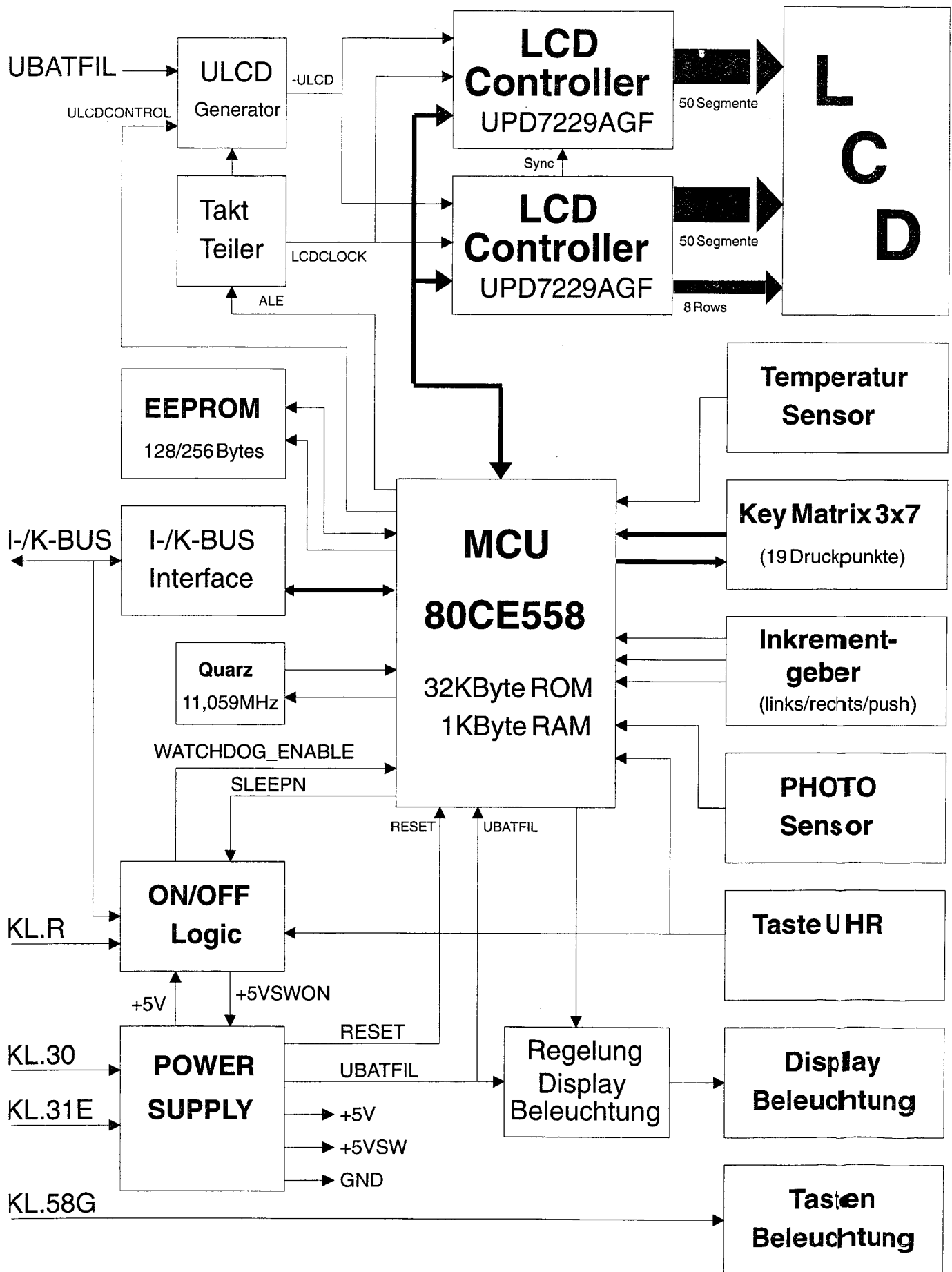

SUPPLY VOLTAGES AND SIGNALS

On/off logic and Power supply

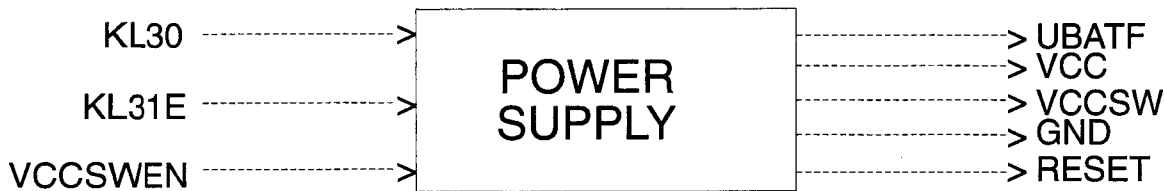
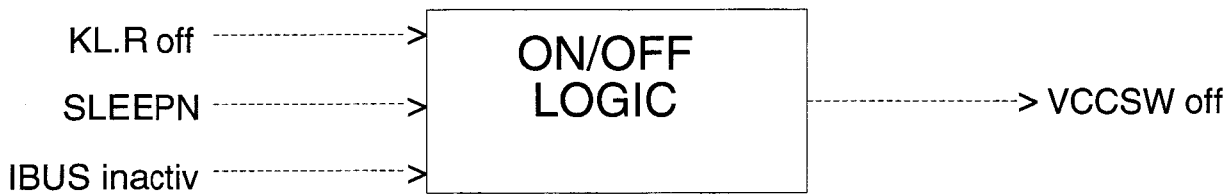
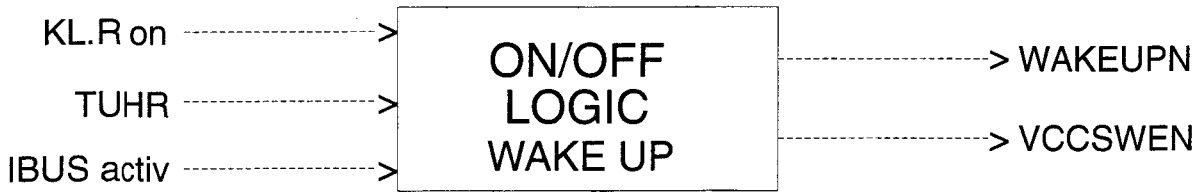

KL.R	Ignition key voltage	14,0 V
KL.30	Battery voltage	14,0 V
KL.31E	GND	0,0 V
TUHR	Clock request	0,0 V when clock button pushed 5,0 V when button inactiv
IBUS	Data line (activ high)	High: 14,0 V Low during data communication
WAKEUPN	µC start up signal (activ low)	Low: ≤ 0,9 V (20 ms) High: 5,0 V
VCCSWEN	Breaking voltage for VCCSW	≤ 0,2 V
SLEEPN	µC standby signal (activ low)	Low: ≤ 0,3 V High: 3 0,6 V
VCC	Supply voltage	+ 5,0 V (+/-2%), max. 50mA
GND	Ground	0,0 V
VCCSW	switched supply voltage	+ 5,0 V (+2%/-5%)
UBATF	filtered battery voltage for display illumination	> 13,0 V, max. 400mA
RESET	Reset-Signal (activ high)	Low: ≤ 0,8 V High: 3 3,85 V (10 ms) Reset when VCC < 4,5V

Keypadmatrix

TROW1 - 7	Scan signal Row 1 - Row 7	5,0 V
TCOL1 - 3	Scan signal Column 1 - Column 3	0,0 V 5,0 V if concerned button is pushed

Photosensor signal

PHOTOSEN	Photosensor signal	5,0 V when dark 0,0 V when bright
----------	--------------------	--------------------------------------

Button illumination

KL58G	Extern illumination	14,0 V
-------	---------------------	--------

Temperature sensor

TEMPSEN	Temperature sensor signal	2,5 V (25°C) 3,3 - 0,8 V for temp. range -40 to +80°C
---------	---------------------------	--

Pulse switch

INRIGHT	turn right	0 V / 5 V alternating
INLEFT	turn left	0 V / 5 V alternating
INPUSH	push	5,0 V 0,0 V when pushed

Display illumination

UBATF	filtered battery voltage for display illumination	> 12,0 V, max. 400mA
UDISIL	Return conductor from display illumination	5 - 12 V (brightness dependend)

Controller Interface

-ULCD	Negative LCD-Voltage	-1,8 V (25°C) -2,7 - -1,0 V for temp. range -40 to +80°C
ULCDCHK	Measuring voltage for LCD-Voltagecontrol	1,4 V
LCDRESET	Reset-signal for LCD-Controller (activ high)	High: 5,0 V (20 ms) signal when KL.30 on Low: 0 V
LCDCLK	Clock for LCD-Controller	230,4 KHz
D0 - D3	Databits for LCD-Controller	Digital line
STBN	Standby not-signal for LCD-Controller	Digital line
BUSYN	Busy not-signal for LCD-Controller	Digital line
C/DN	Control/Data not-signal for LCD-Controller	Digital line
CSN	Chip select not-signal for LCD-Controller	Digital line
KLRON	KL_R voltage control	2,9 V
PWMULCD	Pulse width modulated control signal LCD voltage	ca. 200 Hz
PWMDISIL	Pulse width modulated control signal display ill.	0 - 5 V (brightness dependend), ca. 200 Hz
UBATCON	Battery voltage control	2,9 V
IBUSFIL	Filtered I-BUS signal	13 V
ULCDCLK	Clock frequency for generation of -ULCD	57,6 KHz
ALE	Clock generator for LCD controller	1843,2 KHz

Service connections (only used in production for software download)

RXD	RS232 receive signal (TTL-level)
TXD	RS232 send signal (TTL-level)
SCL	I ² C-Bus clock signal
SDA	I ² C-Bus data signal
SEN/STA	I-BUS control signal

TESTMODE

Hold buttons 10 (RDS resp. AS) and 17 (Preset 6) depressed while switching ignition on (14,4 V to clamp R).
Display will show HXX SXX (XX = Version of hardware resp. software).

Push button 7 (SCAN) within 5 sec. for display test.
One after the other all segments will be shown.
After the display test the program returns to HXX SXX.

Push button 8 (MODE resp. TAPE/CD) within 5 sec. for button test.
Display will show TASTE:—
— will change to the concerned number when you push the buttons.
After the button test the program returns to HXX SXX.

Push button 9 (UP/DOWN resp. RANDOM resp. PROG) within 5 sec. for incremental switch test.
Display will show INKR.:—
Turn the volume knob to the right: The number will increase to 36.
Turn the volume knob to the left: The number will decrease to 00.
After the incremental switch test the program returns to HXX SXX.

To leave the testmode switch set off or wait 5 sec.

EEPROM

The Eeprom mentioned in the partslist is an empty one.
This device can only be programmed with special equipment in factory Wetzlar.
Without a correct programmed Eeprom the IRIS modul does not function according specification.
(Power down, illumination control, LCD contrast)

In case of a defect Eeprom send the set back to:

Philips Apparatefabrik Wetzlar
Department SP-CS
Philipsstrasse 1
D-35576 Wetzlar

Germany

Display + Switch PWB

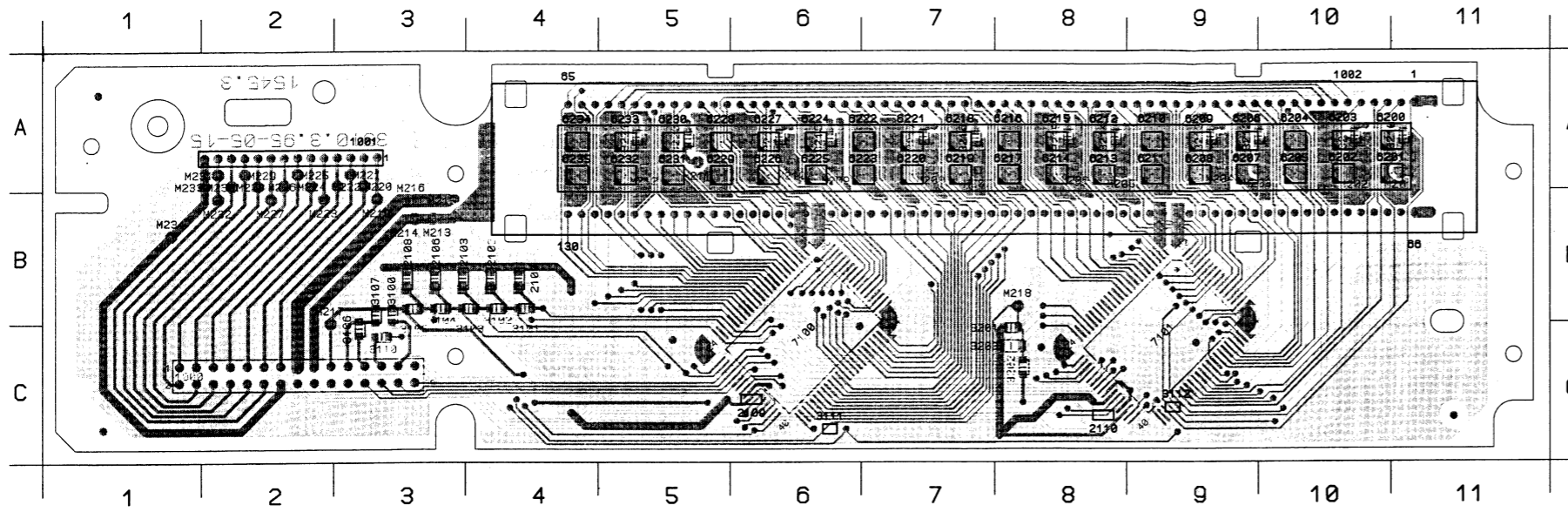

1000 C 2	3202 C 8	6208 A 9	6230 A 5	M215 B 3
1001 A 2	3203 C 8	6209 A 9	6231 A 5	M216 B 3
1002 A 7	3210 A 11	6210 A 9	6232 A 5	M217 B 2
2100 B 4	3211 A 10	6211 A 9	6233 A 5	M218 B 3
2102 B 4	3212 A 10	6212 A 8	6234 A 4	M219 B 3
2103 B 3	3213 A 9	6213 A 8	6235 A 4	M220 A 3
2106 B 3	3214 A 8	6214 A 8	7100 C 6	M221 A 3
2108 B 3	3215 A 8	6215 A 8	7101 C 9	M222 A 3
2109 C 6	3216 A 7	6216 A 8	M201 A 11	M223 B 2
2110 C 8	3217 A 7	6217 A 8	M202 A 10	M224 A 2
3100 B 3	3218 A 6	6218 A 7	M203 A 10	M225 A 2
3101 B 4	3219 A 6	6219 A 7	M204 A 9	M226 A 2
3102 B 4	3220 A 5	6220 A 7	M205 A 8	M227 B 2
3103 B 4	3221 A 5	6221 A 7	M206 A 8	M228 A 2
3104 B 3	6200 A 11	6222 A 7	M207 A 7	M229 A 2
3105 B 3	6201 A 11	6223 A 7	M208 A 7	M230 A 2
3106 C 3	6202 A 10	6224 A 6	M209 A 6	M231 A 2
3107 B 3	6203 A 10	6225 A 6	M210 A 6	M232 B 2
3110 C 3	6204 A 10	6226 A 6	M211 A 5	M233 A 2
3111 C 6	6205 A 10	6227 A 6	M212 A 5	M234 B 1
3112 C 9	6206 A 9	6228 A 5	M213 B 3	
3201 C 8	6207 A 9	6229 A 5	M214 B 3	

1000 A 2	1109 C 4	1119 B 5	2100 B 2	3108 B 2	6107 B 8	M100 B 5	M109 B 2
1101 B 9	1110 B 9	1120 B 1	3100 C 14	3109 B 2	6108 B 10	M101 B 2	M110 B 2
1102 B 6	1112 C 9	1121 B 2	3101 C 14	6100 B 2	6109 C 7	M102 B 2	M111 B 2
1103 C 2	1113 B 5	1122 B 13	3102 A 13	6101 A 13	6110 B 7	M103 B 3	M112 B 2
1104 B 7	1114 B 11	1123 B 14	3103 A 13	6102 C 14	6111 B 5	M104 B 3	M113 B 1
1105 C 6	1115 C 7	1124 A 14	3104 B 10	6103 C 2	6112 C 8	M105 B 3	M114 C 1
1106 C 1	1116 C 6	1125 A 13	3105 B 10	6104 B 13	6113 C 10	M106 B 3	M115 B 2
1107 B 8	1117 C 11	1126 B 12	3106 B 6	6105 A 13	6114 C 13	M107 B 2	
1108 C 8	1118 C 9	1127 A 12	3107 B 6	6106 C 5	7100 B 3	M108 B 2	

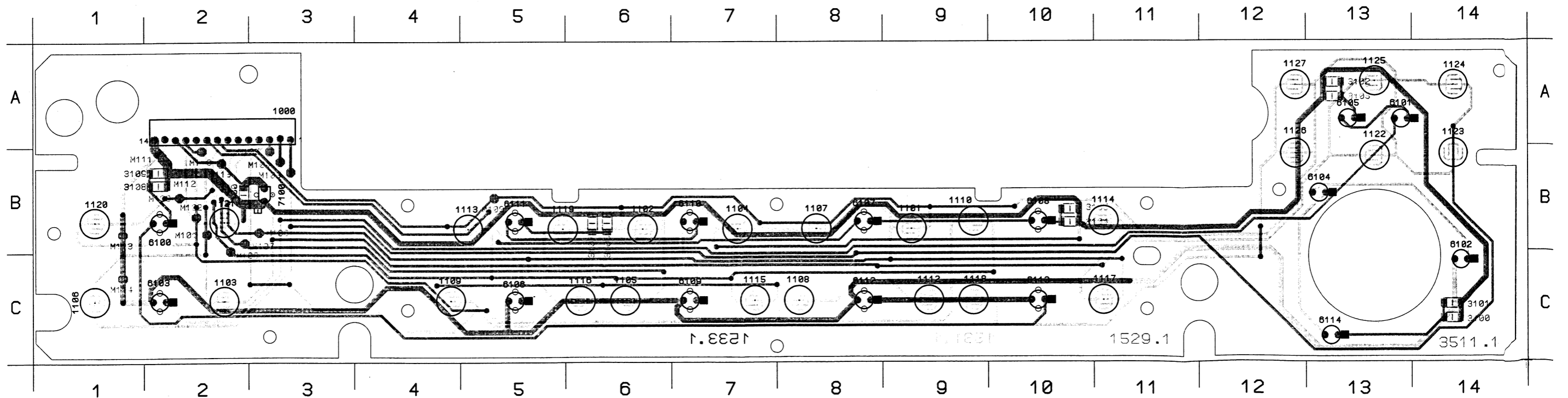

Switches + Display

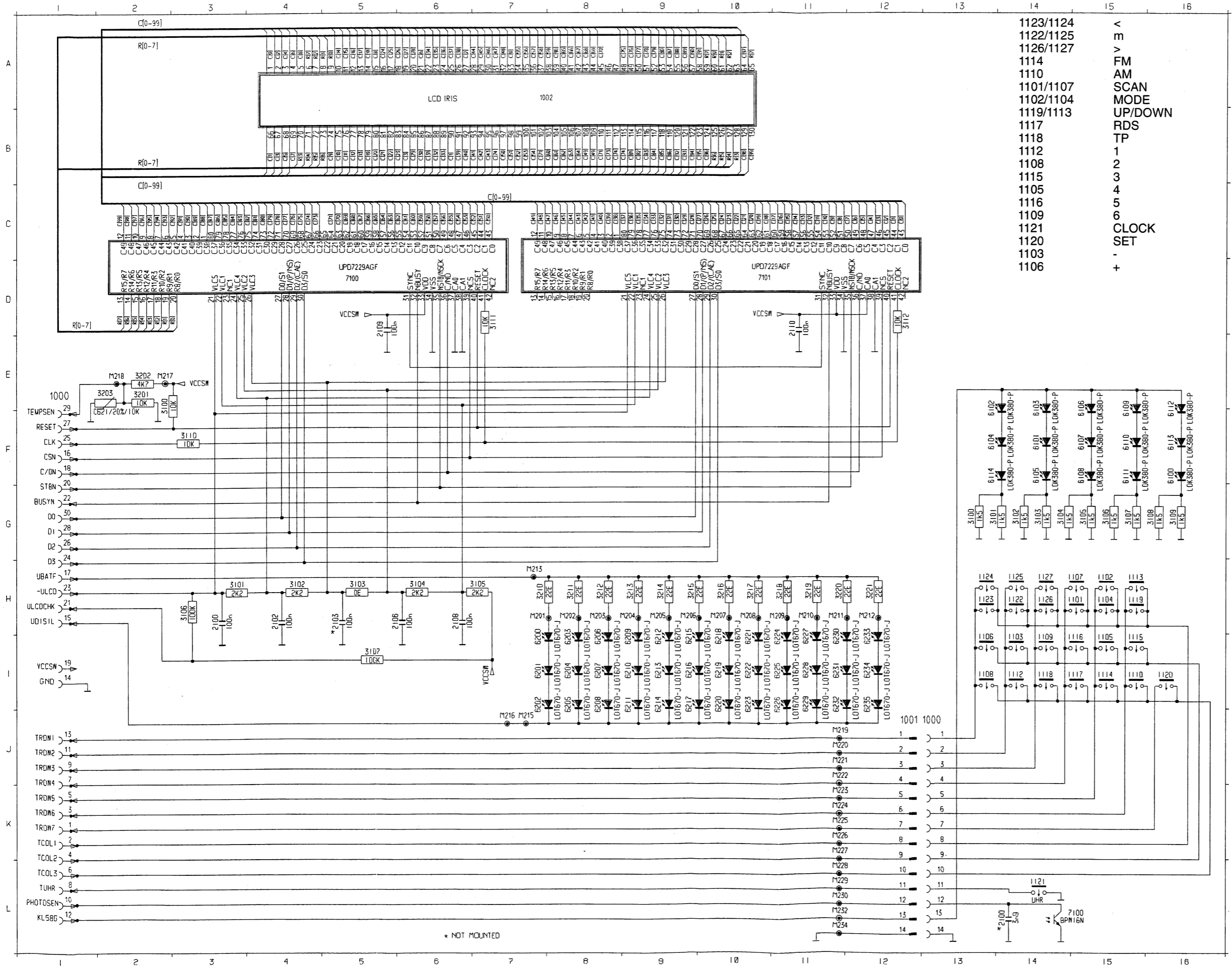

- 1123/1124 <
- 1122/1125 m
- 1126/1127 v
- 1114 FM
- 1110 AM
- 1101/1107 SCAN
- 1102/1104 MODE
- 1119/1113 UP/DOWN
- 1117 RDS
- 1118 TP
- 1112 1
- 1108 2
- 1115 3
- 1105 4
- 1116 5
- 1109 6
- 1121 CLOCK
- 1120 SET
- 1103 +
- 1106

- 1002 A 7
- 1101 H15
- 1102 H15
- 1103 H14
- 1104 H15
- 1105 H15
- 1106 H13
- 1107 H15
- 1108 H13
- 1109 H14
- 1110 H15
- 1112 H14
- 1113 H15
- 1114 H15
- 1115 H15
- 1116 H15
- 1117 H15
- 1118 H14
- 1119 H15
- 1120 H16
- 1121 L14
- 1122 H14
- 1123 H13
- 1124 H13
- 1125 H14
- 1126 H14
- 1127 H14
- 2100 H 3
- 2100 L14
- 2102 H 4
- 2103 H 5
- 2106 H 6
- 2108 H 6
- 2109 O 5
- 2110 O11
- 3100 E 2
- 3100 G13
- 3101 G13
- 3101 H 3
- 3102 H 4
- 3102 G14
- 3103 G14
- 3103 H 5
- 3104 G14
- 3104 H 6
- 3105 H 7
- 3105 G15
- 3106 G15
- 3106 H 3
- 3107 G15
- 3107 I 5
- 3108 G16
- 3109 G16
- 3110 F 3
- 3111 O 7
- 3112 O12
- 3201 E 2
- 3202 E 2
- 3203 E 2
- 3210 H 7
- 3211 H 8
- 3212 H 8
- 3213 H 9
- 3214 H 9
- 3215 H 9
- 3216 H10
- 3217 H10
- 3218 H11
- 3219 H11
- 3220 H11
- 3221 H12
- 6100 F16
- 6101 F14
- 6102 E13
- 6103 E14
- 6104 F13
- 6105 F14
- 6106 E15
- 6107 F15
- 6108 F15
- 6109 E15
- 6110 F15
- 6111 F15
- 6112 E16
- 6113 F16
- 6114 F13
- 6200 I 7
- 6201 I 7
- 6202 I 7
- 6203 I 8
- 6204 I 8
- 6205 I 8
- 6206 I 8
- 6207 I 8
- 6208 I 8
- 6209 I 9
- 6210 I 9

Main PWB

1000 B 1	2121 B 11	2204 B 3	3104 B 11	3252 A 3	3400 A 3	7306 A 3	M124 B 10
1001 C 1	2122 B 11	2205 A 3	3105 A 11	3253 A 3	3404 B 4	7307 A 5	M125 B 11
1002 A 11	2123 B 11	2206 B 4	3110 B 11	3254 A 3	3405 B 4	7310 B 7	M126 B 11
1104 B 8	2124 B 10	2207 B 7	3111 A 10	3255 A 4	4103 A 7	7350 B 3	M127 A 7
1150 B 8	2125 B 11	2208 B 4	3112 B 11	3256 A 3	4350 B 5	7353 B 5	M123 B 11
1151 B 8	2126 B 10	2209 A 7	3113 A 11	3257 A 4	5301 B 7	7380 B 10	M129 A 8
1152 A 9	2127 B 10	2210 B 5	3115 B 9	3258 A 5	5350 A 2	M100 B 10	M130 B 8
1153 A 10	2128 B 8	2211 B 4	3116 A 8	3259 A 4	6200 B 3	M101 B 10	M131 B 11
1154 B 9	2129 B 8	2212 B 4	3119 A 8	3260 A 3	6201 B 3	M102 B 9	M132 C 11
1155 B 9	2130 B 7	2250 A 3	3124 A 11	3261 A 5	6250 A 3	M103 B 9	M133 C 11
1156 B 10	2131 B 7	2251 A 4	3125 A 11	3262 A 3	6251 A 4	M104 A 8	M200 B 3
1157 B 10	2132 B 8	2252 A 4	3153 B 8	3263 A 4	6252 A 3	M105 B 10	M201 A 2
1158 A 8	2133 B 8	2253 A 4	3154 B 4	3300 B 7	6302 A 8	M106 B 10	M202 B 4
2100 A 10	2134 C 8	2300 A 5	3155 B 8	3301 B 7	6304 B 6	M107 B 10	M203 B 3
2103 A 7	2135 C 8	2302 A 7	3156 B 8	3303 B 7	6305 B 6	M108 B 10	M205 A 8
2104 A 10	2136 C 8	2306 A 6	3157 B 8	3316 A 7	6350 B 5	M109 B 7	M206 A 9
2105 A 10	2137 C 9	2307 B 6	3158 B 8	3317 A 6	6351 A 2	M110 B 7	M207 B 11
2106 A 9	2138 B 10	2311 B 6	3159 B 8	3318 A 5	6400 A 3	M111 B 8	M208 A 5
2107 A 10	2139 B 10	2312 B 7	3160 B 7	3319 A 5	6402 B 4	M112 B 8	M209 B 3
2109 B 11	2140 B 10	2313 B 7	3161 B 7	3320 A 6	7100 B 9	M113 B 8	M210 A 2
2110 A 7	2141 B 10	2314 B 7	3172 B 9	3321 A 6	7101 A 8	M114 B 8	M211 A 4
2111 A 11	2142 A 7	2350 B 2	3173 B 9	3322 A 6	7200 B 4	M115 B 9	M300 B 7
2112 A 7	2143 B 11	2351 B 6	3200 B 5	3323 A 5	7201 A 7	M116 B 3	M301 B 7
2114 A 11	2144 B 11	2353 B 5	3201 A 8	3324 C 3	7202 B 4	M117 C 11	M303 A 2
2115 B 7	2145 A 7	2354 B 5	3202 B 4	3350 B 6	7250 A 3	M118 C 11	M304 A 6
2116 B 7	2146 B 7	2380 B 10	3204 B 4	3351 A 7	7251 A 3	M119 B 11	M305 A 5
2117 A 7	2148 B 11	2400 A 2	3205 B 5	3352 B 6	7252 A 4	M120 B 11	M306 A 5
2118 A 10	2201 B 4	2401 B 1	3210 B 3	3355 B 5	7253 A 5	M121 B 10	M307 A 6
2119 A 11	2202 A 2	2402 A 11	3250 A 3	3380 B 10	7302 A 5	M122 B 11	M308 A 8
2120 B 11	2203 B 2	3101 A 10	3251 A 3	3381 B 10	7303 A 6	M123 B 10	M400 A 2

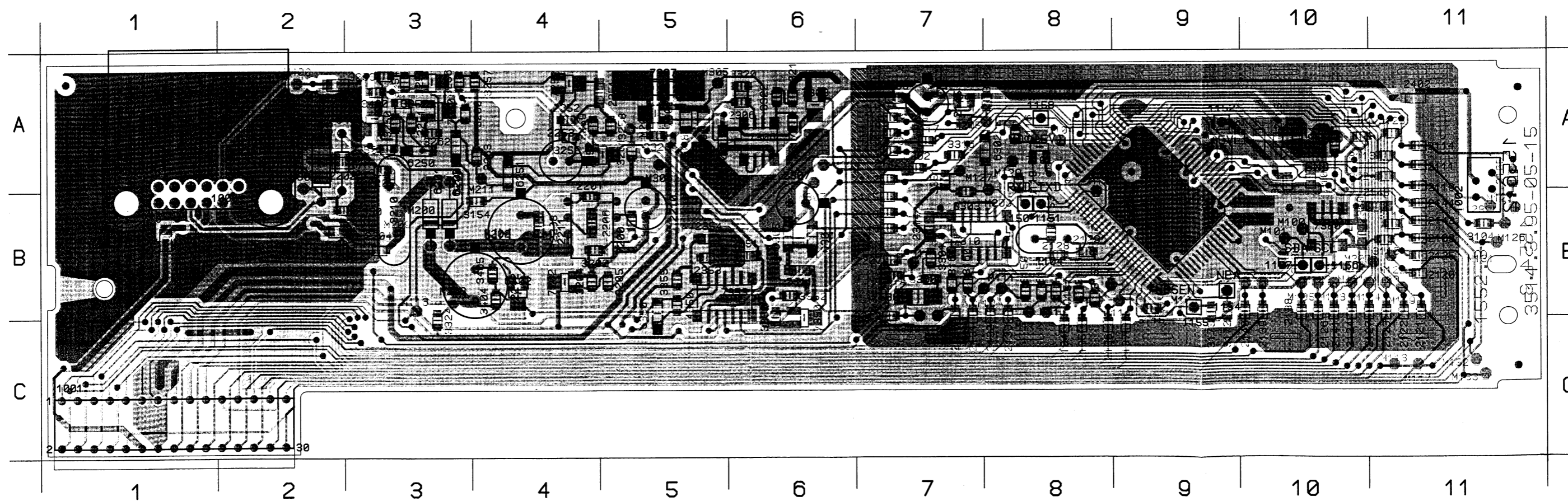

Main

1000	K21	1001	F 1	1001	F 1	1104	A 9	2107	C13	2124	J 6	2139	F 5	2207	A16	2312	A 3	3111	H15	3160	F 8	3255	H17	3319	D 5	4103	C14	6402	I16	7310	B 3	M110	F 4	M125	D14	M207	B16
1000	K21	1001	F 1	1001	F 1	1150	F12	2109	J15	2125	J 6	2140	F 5	2208	C21	2313	D 2	3112	I13	3161	F 8	3256	H18	3320	D 5	4300	G19	7100	A11	7310	B 1	M111	F 4	M126	D14	M208	G15
1000	K20	1001	F 1	1001	F 1	1151	F12	2110	J16	2126	J 7	2141	F13	2209	A18	2314	A 3	3113	O12	3172	B 9	3257	H18	3321	D 5	4301	C 1	7101	D 8	7350	F16	M112	G 4	M127	F12	M211	H20
1000	K20	1001	F 1	1001	F 1	1152	A13	2111	F14	2127	J 7	2142	D 8	2210	C18	2350	G20	3115	C 9	3173	C 9	3258	G16	3322	D 5	4302	G20	7200	B20	7353	G18	M113	G 4	M128	F12	M300	D 3
1000	K20	1001	F 1	1001	F 1	1153	C14	2112	F14	2128	A 8	2143	J15	2211	O21	2351	F19	3116	D 9	3200	B18	3259	G16	3323	D 5	4303	O21	7201	B16	7350	B 5	M114	G 4	M129	F14	M301	A 3
1000	K20	1001	F 1	1001	F 1	1154	B 9	2114	F13	2129	A 8	2144	J15	2212	O21	2352	G20	3119	F19	3202	B18	3260	H19	3324	D 5	4304	O21	7202	B17	7350	B 5	M115	G 4	M130	F14	M303	F21
1000	K20	1001	F 1	1001	F 1	1155	C 9	2115	G13	2130	H 5	2145	A13	2250	H20	2354	G18	3124	O12	3203	B18	3261	G16	3325	D 5	4305	I20	7250	H20	7350	B 5	M116	G 4	M131	I12	M304	C 6
1000	K19	1001	F 1	1001	F 1	1156	B 9	2116	G14	2131	H 5	2146	G14	2251	G16	2355	B 4	3125	O12	3204	A17	3262	G16	3326	D 5	4306	I20	7251	H19	7351	H19	M117	H 4	M132	I12	M305	D 3
1000	K19	1001	F 1	1001	F 1	1157	B 9	2117	J15	2132	H 6	2148	J13	2252	G17	2400	J18	3153	A 9	3205	A17	3263	H19	3327	D 5	4307	I20	7252	H17	7352	H17	M118	H 4	M133	I15	M306	D 3
1000	K19	1001	F 1	1001	F 1	1158	D 9	2118	J14	2133	H 6	2201	C19	2253	H18	2401	K16	3154	A 9	3210	O21	3264	I21	3328	D 5	4308	I20	7253	G16	7353	G16	M119	H 4	M200	F21	M307	A 1
1000	K19	1001	F 1	1001	F 1	1159	D 9	2119	F13	2134	H 6	2202	F21	2300	A 7	2402	D15	3155	A 9	3211	O21	3265	A 3	3329	D 5	4309	A 1	7302	F 2	7353	C 6	M120	F 4	M201	F21	M308	C 5
1001	G 1	1001	J 1	1002	C15	2104	C12	2121	J 5	2136	H 7	2204	F21	2306	D 3	3104	D13	3157	F 9	3212	O21	3266	C 6	3330	D 5	4310	F19	7306	A 7	7354	A 7	M121	F 4	M202	B21	M309	C 5
1001	G 1	1001	J 1	1002	C15	2105	B12	2122	J 6	2137	H 7	2205	F21	2307	B 1	3105	D13	3158	F 9	3213	O21	3267	C 6	3331	D 5	4311	J21	7306	D 4	7354	D 4	M122	F 4	M203	F20	M400	J19
1001	G 1	1001	J 1	1004	D16	2106	B12	2123	J 6	2138	F 5	2206	C19	2311	A 2	3110	I14	3159	F 8	3214	O21	3268	D 5	3405	I17	6400	J18	7307	D 2	7354	D 2	M124	F 4	M206	B16		

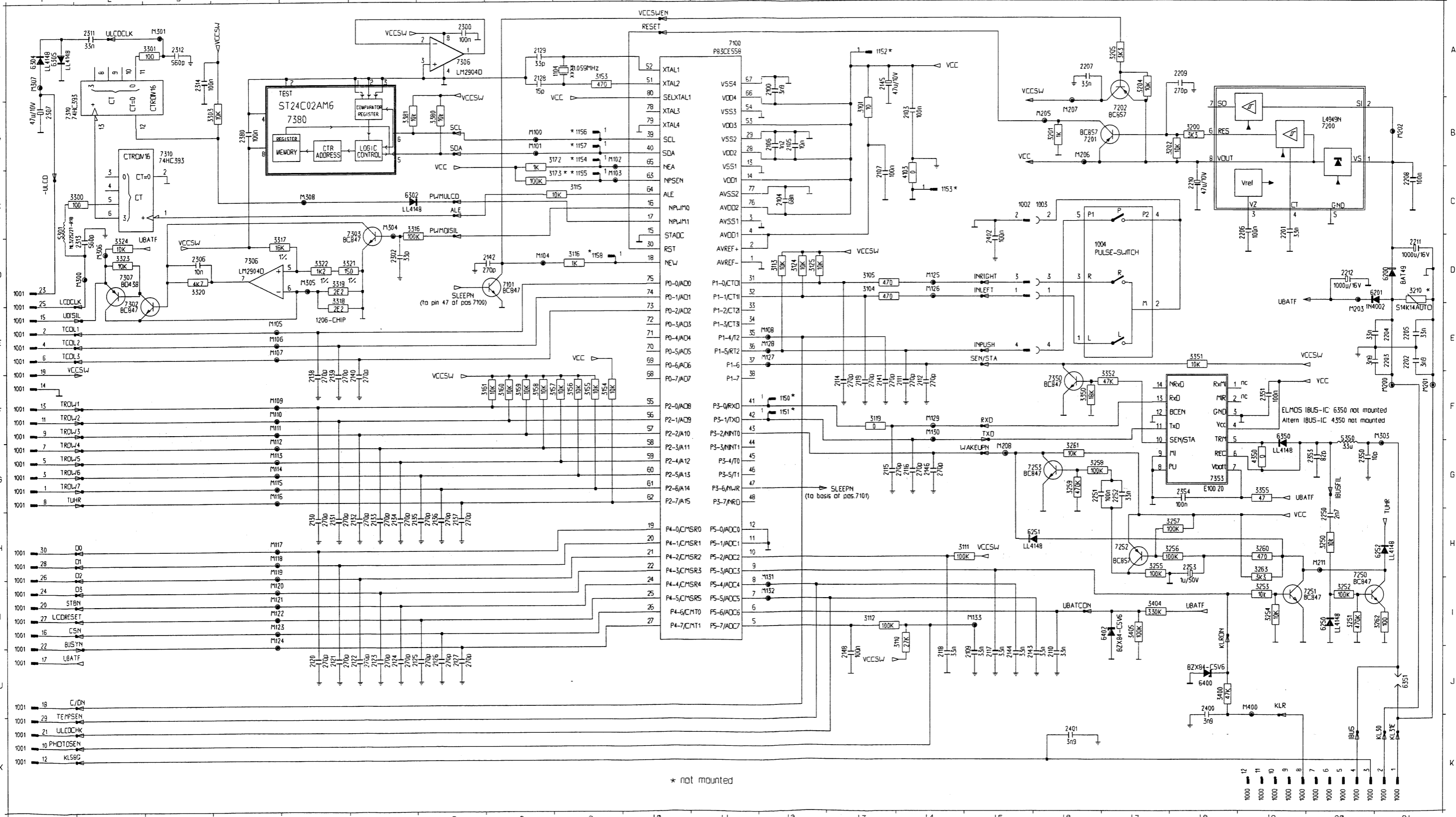

* not mounted

MECHANICAL PARTS

1000-1005-1000	4822 267 51484	CONNECTOR 12-FOLD
1001-1002-3	4822 130 91517	LCD DISPLAY
1001-1003	4822 459 50966	FRONT UNIT OCEANIA
1001-1003	4822 459 50965	FRONT UNIT JAPAN
1001-1003	4822 459 50964	FRONT UNIT ASSY EUROPE
1001-1004-1001	4822 101 30893	POTMETER ROTARY SWITCH
1001-2	4822 413 31871	KNOB ON/OFF/VOLUME

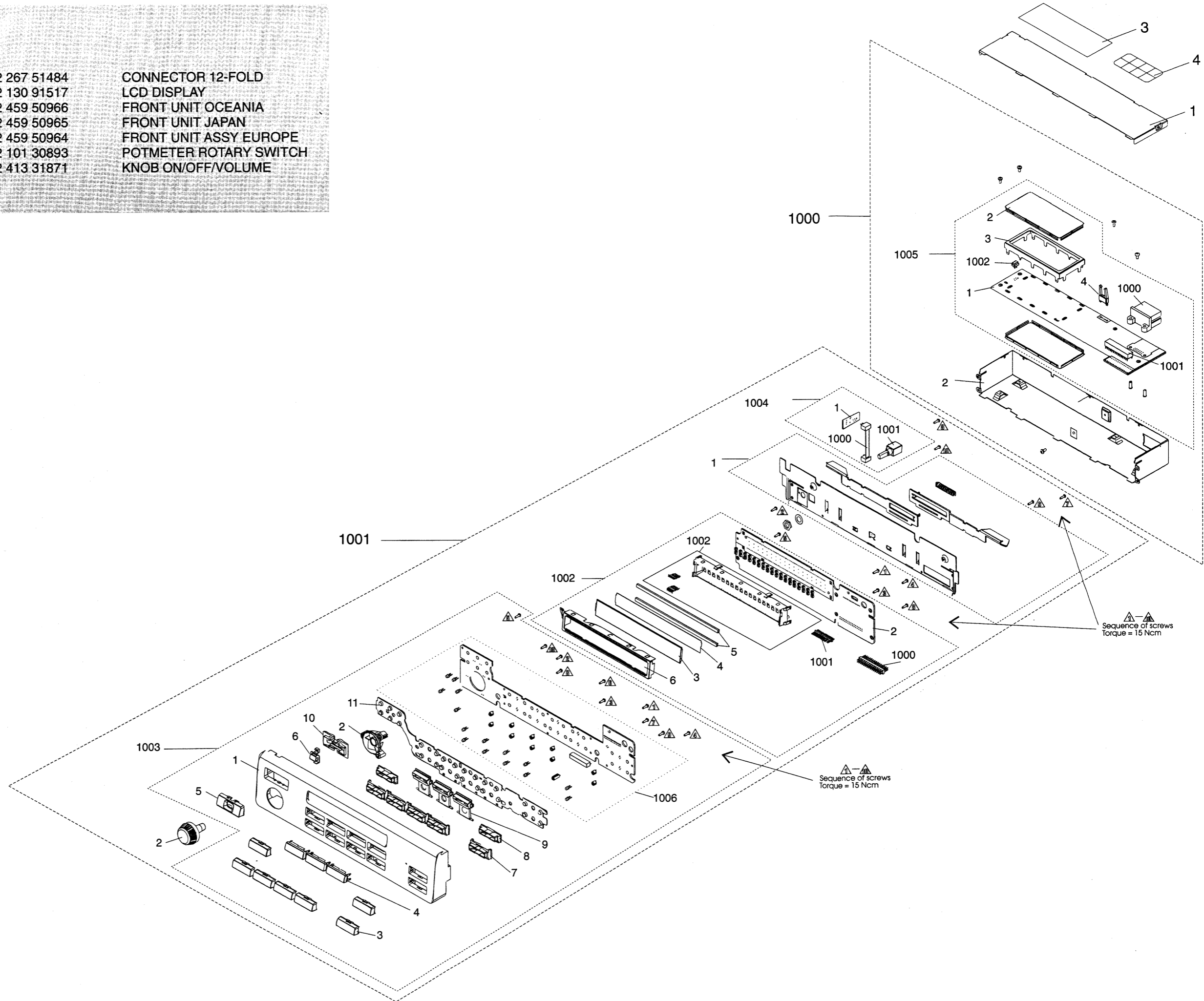

ELECTRICAL PARTSLIST

For all capacitors, resistors and coils not mentioned here, refer to standard component catalogue.

Service code is 4822 736 53404

Miscellaneous

1104 4822 242 81646 CRYSTAL 11.059 MHZ

Capacitors

2109	4822	122	33342	CAP.CHIP	33NF10%X7R	63V
2110	4822	122	33342	CAP.CHIP	33NF10%X7R	63V
2117	4822	122	33342	CAP.CHIP	33NF10%X7R	63V
2118	4822	122	33342	CAP.CHIP	33NF10%X7R	63V
2143	4822	122	33342	CAP.CHIP	33NF10%X7R	63V
2144	4822	122	33342	CAP.CHIP	33NF10%X7R	63V
2145	4822	124	22646	CAP.ELECTROLYT.	47UF20%	16V
2201	4822	122	33342	CAP.CHIP	33NF10%X7R	63V
2204	4822	122	33342	CAP.CHIP	33NF10%X7R	63V
2205	4822	122	33342	CAP.CHIP	33NF10%X7R	63V
2207	4822	122	33342	CAP.CHIP	33NF10%X7R	63V
2210	4822	124	22646	CAP.ELECTROLYT.	47UF20%	16V
2252	4822	122	33342	CAP.CHIP	33NF10%X7R	63V
2253	4822	124	23282	CAP.ELECTROLYT.	1UF20%	50V
2307	4822	124	22646	CAP.ELECTROLYT.	47UF20%	16V
2311	4822	122	33342	CAP.CHIP	33NF10%X7R	63V

Resistors

3203	4822	116	30423	RES.N.T.C.	10K 20% NTC	
3317	4822	117	11751	RES.METAL FILM	16K RC12H 1% 0805	
3322	4822	117	11447	RES.CHIP	1K2 1%	0,1W

Coils

5301 4822 157 71777 COIL 0,18UH

Diodes

6200	4822	130	70005	DIODE	BAT49	
6201	4822	130	81196	RECTIFIER	S5566B	
6250	4822	130	83338	DIODE,CHIP	LL4148	
6251	4822	130	83338	DIODE,CHIP	LL4148	
6252	4822	130	83338	DIODE,CHIP	LL4148	
6302	4822	130	83338	DIODE,CHIP	LL4148	
6304	4822	130	83338	DIODE,CHIP	LL4148	
6305	4822	130	83338	DIODE,CHIP	LL4148	
6351	4822	252	60125	SPARK GAP	DSP201	
6400	4822	130	80125	DIODE,REFERENCE	BZX84-C5V6	
6402	4822	130	80125	DIODE,REFERENCE	BZX84-C5V6	

Transistors and IC's

7100	4822	209	90651	MICROPROCESSOR	P83CE558EFB/060 RC2	
7100	4822	209	90649	MICROPROCESSOR	UPD7229AGF-030-3B9	
7100	4822	130	41739	TRANSIST,PHOTO	BPW16N	
7101	4822	209	90649	MICROPROCESSOR	UPD7229AGF-030-3B9	
7101	4822	130	42705	TRANSISTOR,CHIP	BC847	
7200	4822	209	90017	INTEGR.CIRCUIT	L4949N	
7201	4822	130	61233	TRANSISTOR,CHIP	BC857	
7202	4822	130	61233	TRANSISTOR,CHIP	BC857	
7250	4822	130	42705	TRANSISTOR,CHIP	BC847	
7251	4822	130	42705	TRANSISTOR,CHIP	BC847	
7252	4822	130	61233	TRANSISTOR,CHIP	BC857	
7253	4822	130	42705	TRANSISTOR,CHIP	BC847	
7302	4822	130	42705	TRANSISTOR,CHIP	BC847	
7303	4822	130	42705	TRANSISTOR,CHIP	BC847	
7306	5322	209	12343	I.C. ANALOGUE	LM2904D	
7307	4822	130	40995	TRANSISTOR	BD438	
7310	5322	209	60427	INTEGR.CIRCUIT	74H393D	
7350	4822	130	42705	TRANSISTOR,CHIP	BC847	
7353	4822	209	33841	INTEGR.CIRCUIT	E100.20	
7380	5322	209	52659	I.C. E-PROM	ST24C02CM6	