

DENON

Hi-Fi Integrated Stereo Amplifier

SERVICE MANUAL

MODEL PMA-915R/715R MODEL PMA-915RG/715RG

INTEGRATED STEREO AMPLIFIER

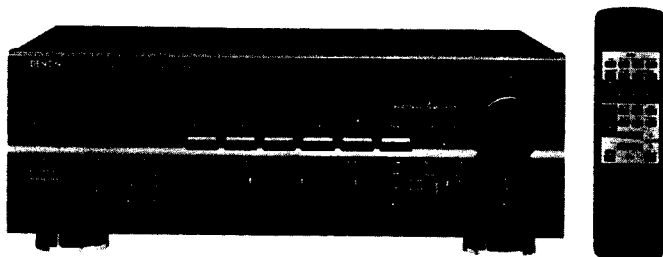

PMA-915R

The photograph shows the PMA-915R.

The PMA-915RG (gold) comes with a side cabinet.

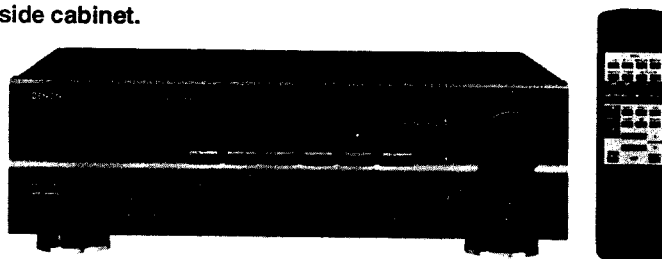

PMA-715R

The photograph shows the PMA-715R.

The PMA-715RG (gold) comes with a side cabinet.

CONTENTS

OPERATING INSTRUCTIONS	2-7
REMOVAL OF EACH SECTION	8, 9
FUNCTION OF NEW CIRCUIT	10, 11
METHOD OF ADJUSTMENTS	12
BLOCK AND LEVEL DIAGRAM	13
SEMICONDUCTORS	14, 15
PRINTED WIRING BOARD (PMA-915R/915RG)	16, 17
PRINTED WIRING BOARD (PMA-715R/715RG)	18, 19
PRINTED WIRING BOARD PARTS LIST	20 ~ 25
WIRING DIAGRAM	26, 27
EXPLODED VIEW OF CHASSIS AND CABINET, PARTS LIST (PMA-915R)	28, 29
EXPLODED VIEW OF CHASSIS AND CABINET, PARTS LIST (PMA-715R)	30, 31
SCHEMATIC DIAGRAM (PMA-915R/915RG)	33
SCHEMATIC DIAGRAM (PMA-715R/715RG)	34
REMOTE CONTROL	35

NIPPON COLUMBIA CO., LTD.

SAFETY INSTRUCTIONS



CAUTION
RISK OF ELECTRIC SHOCK
DO NOT OPEN



CAUTION: TO REDUCE THE RISK OF ELECTRIC SHOCK, DO NOT REMOVE COVER (OR BACK). NO USER SERVICEABLE PARTS INSIDE. REFER SERVICING TO QUALIFIED SERVICE PERSONNEL.



The lightning flash with arrowhead symbol, within an equilateral triangle, is intended to alert the user to the presence of uninsulated "dangerous voltage" within the product's enclosure that may be of sufficient magnitude to constitute a risk of electric shock to persons.



The exclamation point within an equilateral triangle is intended to alert the user to the presence of important operating and maintenance (servicing) instructions in the literature accompanying the appliance.

WARNING: TO REDUCE THE RISK OF FIRE OR ELECTRIC SHOCK, DO NOT EXPOSE THIS APPLIANCE TO RAIN OR MOISTURE.

• FOR U.S.A. & CANADA MODEL ONLY

CAUTION

TO PREVENT ELECTRIC SHOCK DO NOT USE THIS (POLARIZED) PLUG WITH AN EXTENSION CORD, RECEPTACLE OR OTHER OUTLET UNLESS THE BLADES CAN BE FULLY INSERTED TO PREVENT BLADE EXPOSURE.

• POUR LE MODELE CANADIEN UNIQUEMENT

ATTENTION

POUR PREVENIR LES CHOCES ELECTRIQUES NE PAS UTILISER CETTE FICHE POLARISEE AVEC UN PROLONGATEUR UNE PRISE DE COURANT OU UNE AUTRE SORTIE DE COURANT, SAUF SI LES LAMES PEUVENT ETRE INSEREES A FOND SANS EN LAISSER AUCUNE PARTIE A DECOUVERT.

• NUR FÜR EUROPÄISCHE MODELLE

Konformitätserklärung

Die DENON Electronic GmbH
 Halskestraße 32
 40880 Ratingen

Erklärt als Hersteller/Importeur, daß das in dieser Bedienungsanleitung beschriebene Gerät den Technischen Vorschriften für Ton- und Fernseh-Rundfunkempfänger nach der Amtsblattverfügung 868/1989 (Amtsblatt des Bundesministers für Post und Telekommunikation vom 31. 8. 1989) entspricht.

1. Read Instructions – All the safety and operating instructions should be read before the appliance is operated.
2. Retain Instructions – The safety and operating instructions should be retained for future reference.
3. Heed Warnings – All warnings on the appliance and in the operating instructions should be adhered to.
4. Follow Instructions – All operating and use instructions should be followed.
5. Water and Moisture – The appliance should not be used near water – for example, near a bathtub, washbowl, kitchen sink, laundry tub, in a wet basement, or near a swimming pool, and the like.
6. Carts and Stands – The appliance should be used only with a cart or stand that is recommended by the manufacturer.
- 6A. An appliance and cart combination should be moved with care. Quick stops, excessive force, and uneven surfaces may cause the appliance and cart combination to overturn.
7. Wall or Ceiling Mounting – The appliance should be mounted to a wall or ceiling only as recommended by the manufacturer.
8. Ventilation – The appliance should be situated so that its location or position does not interfere with its proper ventilation. For example, the appliance should not be situated on a bed, sofa, rug, or similar surface that may block the ventilation openings; or, placed in a built-in installation, such as a bookcase or cabinet that may impede the flow of air through the ventilation openings.
9. Heat – The appliance should be situated away from heat sources such as radiators, heat registers, stoves, or other appliances (including amplifiers) that produce heat.
10. Power Sources – The appliance should be connected to a power supply only of the type described in the operating instructions or as marked on the appliance.
11. Grounding or Polarization – Precautions should be taken so that the grounding or polarization means of an appliance is not defeated.
12. Power-Cord Protection – Power-supply cords should be routed so that they are not likely to be walked on or pinched by items placed upon or against them, paying particular attention to cords at plugs, convenience receptacles, and the point where they exit from the appliance.
14. Cleaning – The appliance should be cleaned only as recommended by the manufacturer.
15. Power Lines – An outdoor antenna should be located away from power lines.
16. Outdoor Antenna Grounding – If an outside antenna is connected to the receiver, be sure the antenna system is grounded so as to provide some protection against voltage surges and built-up static charges. Article 810 of the National Electrical Code, ANSI/NFPA 70, provides information with regard to proper grounding of the mast and supporting structure, grounding of the lead-in wire to an antenna-discharge unit, size of grounding conductors, location of antenna-discharge unit, connection to grounding electrodes, and requirements for the grounding electrode. See Figure A.
17. Nonuse Periods – The power cord of the appliance should be unplugged from the outlet when left unused for a long period of time.
18. Object and Liquid Entry – Care should be taken so that objects do not fall and liquids are not spilled into the enclosure through openings.
19. Damage Requiring Service – The appliance should be serviced by qualified service personnel when:
 - A. The power-supply cord or the plug has been damaged; or
 - B. Objects have fallen, or liquid has been spilled into the appliance; or
 - C. The appliance has been exposed to rain; or
 - D. The appliance does not appear to operate normally or exhibits a marked change in performance; or
 - E. The appliance has been dropped, or the enclosure damaged.
20. Servicing – The user should not attempt to service the appliance beyond that described in the operating instructions. All other servicing should be referred to qualified service personnel.

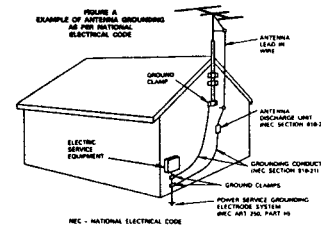

NOTE:

1. Always keep the POWER switch on the main unit turned on.
2. Turn the power on and off from the remote control unit.
3. Unplug the power cord when you do not plan to use the unit for a long period of time.

CAUTION:

If only the MUTE/STANDBY LED is lit, this means that the power is turned off from the remote control unit. Turn the power on from the remote control unit.

HINWEIS:

1. Lassen Sie den Netzschalter (POWER) am Hauptgerät stets eingeschaltet.
2. Schalten Sie den Strom mit dem Fernbedienungsgerät ein und aus.
3. Trennen Sie das Netzkabel vom Netz ab, wenn Sie beabsichtigen, das Gerät über einen längeren Zeitraum hinweg nicht zu benutzen.

VORSICHT:

Wenn nur das Stummschalt-/Bereitschafts-LED (MUTE/STANDBY) leuchtet, so bedeutet dies, daß der Strom vom Fernbedienungsgerät aus ausgeschaltet worden ist. Schalten Sie den Strom vom Fernbedienungsgerät aus ein.

REMARQUE:

1. S'assurer que le commutateur d'alimentation (POWER) sur l'unité principale soit toujours dans la position active.
2. Allumer et éteindre l'appareil avec la télécommande.
3. Débrancher le cordon d'alimentation lorsque l'appareil ne sera pas utilisé pendant une longue période.

ATTENTION:

Si seul le témoin (LED) de sourdine/veille (MUTE/STANDBY) est allumé, cela signifie que l'appareil est mis hors circuit par la télécommande. Allumer l'appareil avec la télécommande.

NOTA:

1. Tenete sempre l'interruttore della corrente (POWER) dell'unità principale nella posizione di attivazione.
2. Accendete e spegnete la corrente usando il telecomando.
3. Scollegate il filo di alimentazione quando avete intenzione di non usare l'apparecchio per un lungo periodo.

AVVISO:

Se sono illuminati solo i LED di attenuazione/attesa (MUTE/STANDBY), questo significa che la corrente è stata spenta con il telecomando. Riaccendete la corrente usando il telecomando.

PRECAUTIONS FOR INSTALLATION

Leave at least 10cm of space between this unit and any other component placed above.

SICHERHEITSMASSNAHMEN BEIM EINBAU

Lassen einen Mindestabstand von 10 cm zwischen diesem Gerät und der anderen Komponente, die daraufgestellt wird.

PRECAUTIONS D'INSTALLATION

Prévoir un espace d'au moins 10cm entre l'unité et tout autre appareil se trouvant au dessus.

PRECAUZIONI PER L'INSTALLAZIONE

Lasciate uno spazio libero di almeno 10 cm fra quest'unità e qualsiasi altro componente che è collocato sopra la stessa.

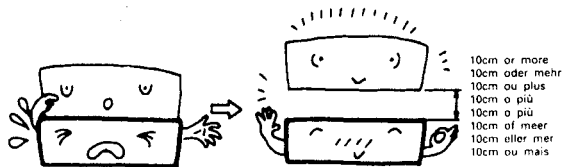
**NOTA:**

1. Mantenga siempre activado el interruptor de alimentación (POWER) en la unidad principal.
2. Encienda y apague el equipo desde la unidad de control remoto.
3. Cuando la unidad vaya a estar fuera de uso por un período prolongado de tiempo, desconecte el cable de alimentación.

PRECAUCION:

Cuando sólo el indicador LED de silenciamiento/modo de espera (MUTE/STANDBY) esté encendido, significará que la alimentación a la unidad ha sido desconectada desde la unidad de control remoto. Conecte la alimentación desde la unidad de control remoto.

OPMERKING:

1. Zorg er altijd voor dat de stroomschakelaar (POWER) van het hoofdtoestel in de ingeschakelde stand staat.
2. Schakel de stroom in en uit m.b.v. de afstandsbediening.
3. Trek het netsnoer uit wanneer u denkt het toestel gedurende een lange periode niet te gebruiken.

WAARSCHUWING:

Indien enkel de dempings-(MUTE/STANDBY) LED brandt, betekent dit dat de spanning met de afstandsbediening is uitgeschakeld. Schakel de spanning in met de afstandsbediening.

OBSERVA:

1. Låt alltid strömbrytaren (POWER) på huvudenheten vara påslagen.
2. Slå till/från strömmen med hjälp av fjärrkontrollen.
3. Koppla loss nätkabeln om apparaten inte skall användas under lång tid.

OBSERVA:

Om endast MUTE/STANDBY-lampen lyser betyder det att strömmen har stängts av via fjärrkontrollen. Strömmen måste då slås på via fjärrkontrollen igen.

NOTA:

1. Mantenha o interruptor da Corrente (POWER) na unidade principal sempre ligado.
2. Ligue e desligue a corrente a partir da unidade de controlo remoto.
3. Desconecte o fio do força quando intentar não utilizar a unidade por longo tempo.

PRECAUÇÃO:

Se apenas se luminar o LED de sudaína/espera (MUTE/STANDBY), isto significa que a força se desligou a partir do controlo remoto. Ligue a força a partir do controlo remoto.

PRECAUCIONES PARA LA INSTALACION

Deje por lo menos 10 cm. de espacio entre esta unidad y cualquier otro componente situado sobre ella.

VOORZORGSMAATREGELEN

Bij plaatsing dient u een ruimte van minstens 10 cm open te laten tussen dit toestel en een ander erop geplaatst component.

FÖRSIKTIGHETSÅTGÄRDER VID INSTALLATIONEN

Sn till att det finns minst 10 cm mellanrum mellan apparaten och en annan apparat som ställs ovanpå.

CUIDADOS NA INSTALAÇÃO

Deixe um espaço de pelo menos 10 cm entre esta unidade e qualquer outro componente colocado acima.

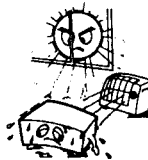
**NOTE ON USE/HINWEISE ZUM GEBRAUCH/OBSERVATIONS RELATIVES A L'UTILISATION
NOTE SULL'USO/NOTAS SOBRE EL USO/ALVORENS TE GEBRUIKEN/OBSERVERA
OBSERVAÇÕES QUANTO AO USO**

- Avoid high temperatures. Allow for sufficient heat dispersion when installed on a rack.
- Vermeiden Sie hohe Temperaturen. Beachten Sie, daß eine ausreichende Luftzirkulation gewährleistet wird, wenn das Gerät auf ein Regal gestellt wird.
- Evitar des temperaturas elevadas. Tener compte d'une dispersion de chaleur suffisante lors de l'installation sur une étagère.
- Evitate di esporre l'unità a temperature alte. Assicuratevi che ci sia un'adeguata dispersione del calore quando installate l'unità in un mobile per componenti audio.
- Evite altas temperaturas. Permita la suficiente dispersión del calor cuando está instalado en la consola.
- Vermijd hoge temperaturen. Zorg voor een degelijke hitteafvoer indien het apparaat op een rek wordt geplaatst.
- Undvitt høge temperaturer. Se till att det finns möjlighet till god värmeavledning vid montering i ett rack.
- Evite temperaturas altas. Conceda suficiente dispersão de calor quando o equipamento for instalado numa prateleira.



- Handle the power cord carefully. Hold the plug when unplugging the cord.
- Gehen Sie vorsichtig mit dem Netzkabel um. Halten Sie das Kabel am Stecker, wenn Sie den Stecker herausziehen.
- Manipuler le cordon d'alimentation avec précaution. Tenir la prise lors du débranchement du cordon.
- Maneggiare il filo di alimentazione con cura. Agite per la spina quando scollegate il cavo dalla presa.
- Maneje el cordón de energía con cuidado. Sostenga el enchufe cuando desconecte el cordón de energía.
- Hanteer het netsnoer voorzichtig. Houd het snoer bij de stekker vast wanneer deze moet worden aan- of losgekoppeld.
- Hantera nätkabeln varsamt. Håll i kabeln när den kopplas från eluttaget.
- Manuseie com cuidado o fio condutor de energia. Segure a tomada ao desconectar o fio.



- Keep the set free from moisture, water, and dust.
- Halten Sie das Gerät von Feuchtigkeit, Wasser und Staub fern.
- Protéger l'appareil contre l'humidité, l'eau et la poussière.
- Tenete l'unità lontana dall'umidità, dall'acqua e dalla polvere.
- Mantenga el equipo libre de humedad, agua y polvo.
- Laat geen vochtigheid, water of stof in het apparaat binnendringen.
- Usätt inte apparaten för fukt, vatten och damm.
- Mantenha o aparelho livre de qualquer umidade, água ou poeira.

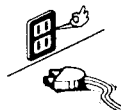

- Unplug the power cord when not using the set for long periods of time.
- Wenn das Gerät eine längere Zeit nicht verwendet werden soll, trennen Sie das Netzkabel vom Netzstecker.
- Débrancher le cordon d'alimentation lorsque l'appareil n'est pas utilisé pendant de longues périodes.
- Disinnestate il filo di alimentazione quando avete l'intenzione di non usare il filo di alimentazione per un lungo periodo di tempo.
- Desconecte el cordón de energía cuando no utilice el equipo por mucho tiempo.
- Neem altijd het netsnoer uit het stopcontact wanneer het apparaat gedurende een lange periode niet wordt gebruikt.
- Koppla ur nätkabeln om apparaten inte kommer att användas i lång tid.
- Desligue o fio condutor de força quando o aparelho não tiver que ser usado por um longo período.



* (For sets with ventilation holes)

- Do not obstruct the ventilation holes.
- Die Belüftungsöffnungen dürfen nicht verdeckt werden.
- Ne pas obstruer les trous d'aération.
- Non coprire i fori di ventilazione.
- No obstruya los orificios de ventilación. De ventilatieopeningen mogen niet worden beblokkeerd.
- Tapp inte till ventilationsöppningarna.
- Não obstrua os orificios de ventilação.



- Do not let foreign objects in the set.
- Keine fremden Gegenstände in das Gerät kommen lassen.
- Ne pas laisser des objets étrangers dans l'appareil.
- E' importante che nessun oggetto e inserito all'interno dell'unità.
- No deje objetos extraños dentro del equipo.
- Laat geen vreemde voorwerpen in dit apparaat vallen.
- Se till att frammande föremål inte tränger in i apparaten.
- Não deixe objetos estranhos no aparelho.



- Do not let insecticides, benzene, and thinner come in contact with the set.
- Lassen Sie das Gerät nicht mit Insektiziden, Benzin oder Verdünnungsmitteln in Berührung kommen.
- Ne pas mettre en contact des insecticides, du benzène et un diluant avec l'appareil.
- Assicuratevi che l'unità non venga in contatto con insetticidi, benzolo o solventi.
- No permita el contacto de insecticidas, gasolina y diluyentes con el equipo.
- Laat geen insectenverdelgende middelen, benzine of verdunder met dit apparaat in contact komen.
- Se till att inte insektmedel på spraybruk, bensin och thinner kommer i kontakt med apparatens hölje.
- Não permita que inseticidas, benzina e dissolvente entrem em contacto com o aparelho.



- Never disassemble or modify the set in any way.
- Versuchen Sie niemals das Gerät auseinander zu nehmen oder auf jegliche Art zu verändern.
- Ne jamais démonter ou modifier l'appareil d'une manière ou d'une autre.
- Non smontate mai, né modificate l'unità in nessun modo.
- Nunca desarme o modifique el equipo de ninguna manera.
- Noör dit apparat demonteren of op andere wijze modifieren.
- Ta inte isär apparaten och försök inte bygga om den.
- Nunca desmonte ou modifique o aparelho de alguma forma.

**FRONT PANEL
FRONTPLATTE
PANNEAU AVANT
PANNELLO ANTERIORE**

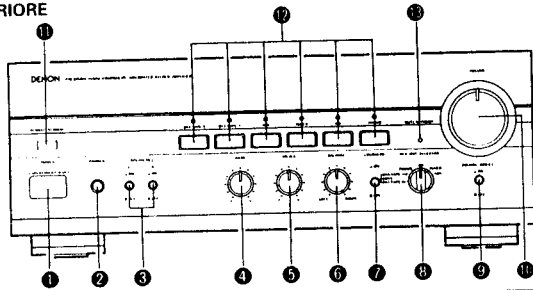

**REAR PANEL
RÜCKWAND
PANNEAU ARRIERE
PANNELLO POSTERIORE**

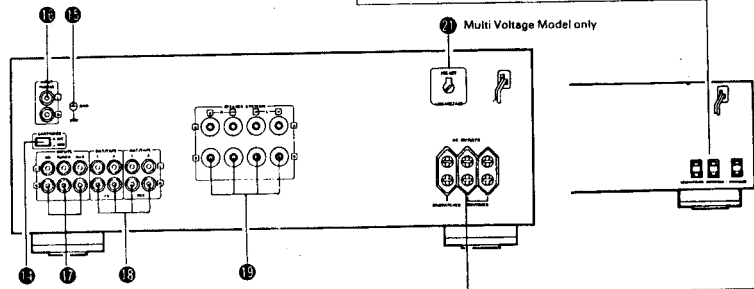

20 • U.S.A., CANADA and Multi Voltage Model only
 • Nur für Modelle für die U.S.A. und KANADA und für Multispannungsmodelle
 • Seulement pour les modèles pour les U.S.A., le CANADA et à tension multiple
 • Solo per i modelli U.S.A. e CANADA e per il modello a voltaggio multiplo

21 • Europe model only (except for U.K.)
 • Nur für Europa-Modell (mit Ausnahme Großbritannien)
 • Seulement pour le modèle européen (à l'exception du Royaume-Uni)
 • Solo per il modello destinato all'Europa (eccetto il Regno Unito)

21 **LINE VOLTAGE (Voltage select switch) . . . For Multi-voltage model only.**
 • The desired voltage may be set with the VOLTAGE SELECTOR KNOB on the back panel using a screw driver.
 • Do not twist the VOLTAGE SELECTOR KNOB with excessive force. It may be damaged.
 • If the voltage select switch does not turn smoothly, see qualified serviceman.



1 CARTRIDGE	2 GND	3 PHONO	4 CD, TUNER, AUX	5 DAT/TAPE-1, DAT/TAPE-2 • TAPE PB • TAPE REC	6 SPEAKERS
Cartridge Selector Switch	GND	Phono Input Terminals (Phono)	Input Terminals (CD, TUNER, AUX)	Playback and Recording Terminals • Playback Terminals • Recording Terminals	Speaker Terminals
Tonabnehmer-Wahlschalter	GND	Schallplatten-Eingangsbuchsen (Phono)	Eingangsbuchsen (CD, TUNER, AUX)	Tonband-Ein/Ausgänge • Wiedergabe • Aufnahme	Lautsprecher-Terminalen
Sélecteur de cartouche	GND	Bornes d'entrée (Phono)	Bornes d'entrée (CD, TUNER, AUX)	Bornes de lecture et d'enregistrement • Bornes de lecture • Bornes d'enregistrement	Bornes de haut-parleurs
Interruttore di selezione cartuccia	GND	Terminali di ingresso Phono	Terminali di ingresso (CD, TUNER, AUX)	Terminali di riproduzione registrazione • Terminali di riproduzione • Terminali di registrazione	Terminali degli altoparlanti

Fig. 1
Abb. 1

**CONNECTIONS
ANSCHLÜSSE
CONNEXIONS
CONNESSIONI**

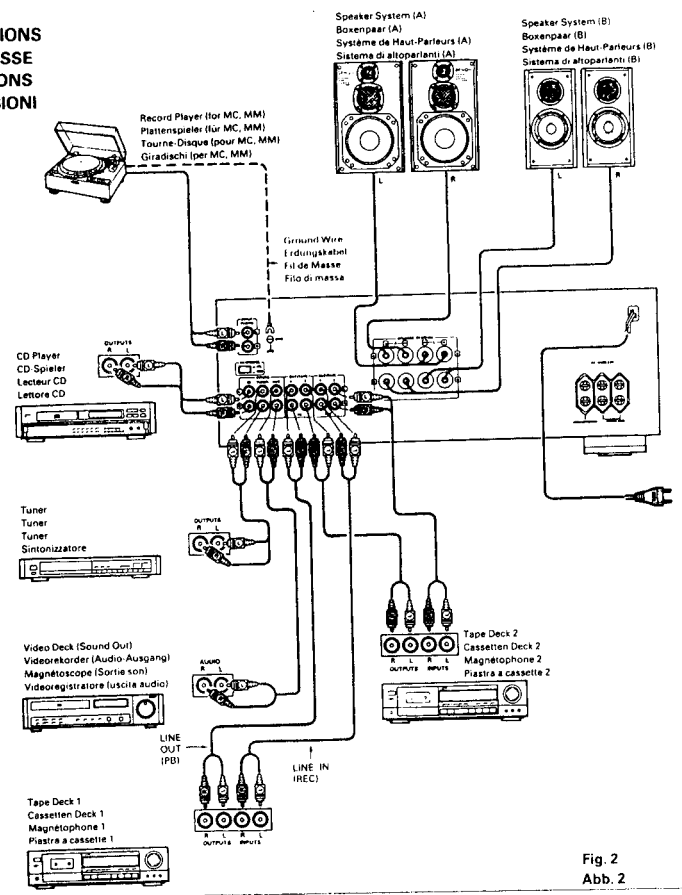

Fig. 2
Abb. 2

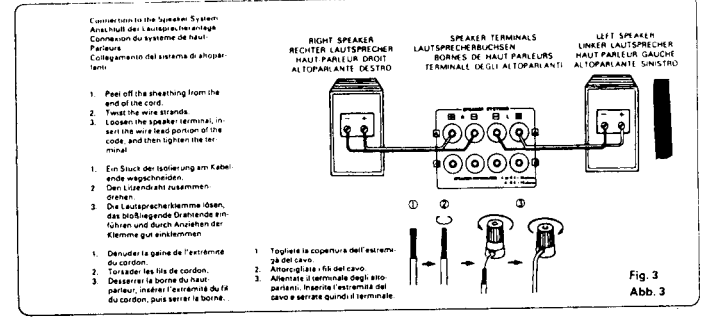



Fig. 3
Abb. 3

DESIGNATIONS AND FUNCTIONS OF PANEL CONTROLS

1 POWER (Power Switch)

When the power switch is turned ON (), the MUTE/STANDBY LED () lights.

When the power switch is turned ON, power is supplied to the unit. It takes a few seconds after the power is turned on for the unit to warm up. This is due to the built-in muting circuit that eliminates noise during the on/off operation.

2 PHONES (Headphone Jack)

This jack is used to plug in the headphones.



3 SPEAKERS (Speaker Selection Switch)

The PMA-915R/715R can be connected to two speaker systems: speaker system A and speaker system B. When A is pressed, the speaker system connected to speaker output terminals A operates.



When B is pressed, the speaker system connected to speaker output terminals B operates.

When A and B are pressed on together, both speaker systems operate simultaneously. When the A and B switches are both off (in the out position), there is no output from the speaker terminals. This setting is used to listen to playback through the headphones.



4 BASS (Bass Control)

This knob is used to control the bass quality of the sound. When the knob is set at the center position, the frequency characteristics are flattened in the range below 1000 Hz. The bass is emphasized as the knob is moved off center to the right (), and reduced as it is moved to the left (). When volume control () is set to the right of the center position, the effect of the other controls is reduced.

5 TREBLE (Treble Control)

This knob is used to control the treble quality of the sound. When the knob is set at the center position, the frequency characteristics are flattened in the range above 1000 Hz. The treble is emphasized as the knob is moved off center to the right (), and reduced as it is moved to the left (). When volume control () is set to the right of the center position, the effect of the other controls is reduced.

6 BALANCE (Balance Control)



This knob is used to adjust the balance between the left and right channels. When it is set to the center position, the amplitude of the amplifier is equal on both sides. If there is a difference in the left and right channel output voltages for a cartridge, move the knob to the left and the right to adjust it. If the volume on the right side is too low, turn the knob to the right (). If the volume on the left side is too low, turn the knob to the left (). This will achieve an even balance on the left and right sides.

7 LOUDNESS (Loudness Switch)



When the volume is low, it is difficult for the human ear to clearly distinguish notes in the low and high frequency ranges. The loudness switch allows a simple "one-touch" correction of this difficulty. Press the loudness switch ON () when listening to music at a low volume. The low notes and high notes will be corrected to produce a natural sound.

8 REC OUT SELECTOR (Rec Out Select Switch)



Use this switch to select the recording component.

- PHONO: Used to recording from the turntable.
- CD: Used to recording from the CD player.
- TUNER: Used to recording from the tuner.
- AUX: Used to recording component that connected to the AUX terminal.
- DAT/TAPE-1  2: Used to recording from the tape deck connected to the DAT/TAPE-1 jacks.
- DAT/TAPE-2  1: Used to recording from the tape deck connected to the DAT/TAPE-2 jacks.

9 SOURCE DIRECT (Source Direct Switch)

The controls (BALANCE, LOUDNESS, and TONE) can be used when this switch is in the OFF () position. When set to the ON () position, the above controls are by-passed and the signals are input directly to the volume control circuit, providing high quality sound.

10 VOLUME (Volume Control)

This knob controls the overall volume level. Turn the knob to the right () to raise the volume and to the left () to lower it.

11 REMOTE SENSOR (Remote Control Sensor)

This sensor receives the infra-red light transmitted from the wireless remote control unit. For remote control, point the wireless remote control unit towards the sensor.

12 INPUT SELECTOR (Input Select Switch)

Use these to select the program source. When the button for the desired program source is selected, its LED lights. One program source only can be selected at a time, as follows:



- PHONO: Used to select the output from a turntable that is connected to the PHONO terminal. Use the PHONO switch () (Rear Panel Side) to switch the sensitivity to correspond to the cartridge type being used.
- CD: Used to listen a compact disc player or other component that is connected to the CD terminal.
- TUNER: Used to play a component such as an FM/AM tuner or a TV tuner that is connected to the TUNER terminal.
- AUX: Used to play a component such as a Hi Fi video player, TV tuner, 8-track tape player or tape deck that is connected to the AUX terminal.
- DAT/TAPE-1: Use this Position when using the tape deck, etc., connected to the DAT/TAPE-1 jacks.
- DAT/TAPE-2: Use this Position when using the tape deck, etc., connected to the DAT/TAPE-2 jacks.

13 MUTE/STANDBY LED

This LED flashes while the muting circuit is activated when the power is turned on and when muting is turned on from the remote control unit, and remains lit (without flashing) while the power is on.

14 PHONO (Cartridge Selection Switch): Rear Panel Side

This switch is set according to the type of player cartridge to be used.

- MC (): Used when an MC (moving-coil) cartridge with an output of less than 0.5 mV is used.
- MM (): Used when an MM (moving-magnet) cartridge with an output of 2 mV or more is used.

20 AC OUTLETS: Rear Panel Side

• For U.S.A. and Canada models.
AC outlets are used for connecting amplifier component units, such as tuner, turntable, tape deck, etc.

• SWITCHED (Total capacity: 120 W):
These outlets are turned ON/OFF when main power switch and POWER button on the Remote Control Unit is turned on/off.

• UNSWITCHED (Capacity: 240 W)
This outlet is always ON whether power switch is on or OFF.

• For Europe (except the U.K.) and Multi-Voltage models.
AC outlets are used for connecting amplifier component units, such as tuner, turntable, tape deck, etc.

• SWITCHED (Total capacity: 100 W):
These outlets are turned ON/OFF when main power switch and POWER button on the Remote Control Unit is turned on/off.

• UNSWITCHED (Capacity: 100 W)
This outlet is always ON whether power switch is on or OFF.

OPERATION

PREPARATION

1. CHECKING CONNECTIONS

- Make sure that all the connections are proper by referring to the back panel. (Fig. 2, 3)
- Check the polarity (positive and negative) of connections, and the directivity of stereo separation (right cord to right channel terminal, and left cord to left channel terminal).
- Check the directivity of pin cord connection.

2. SETTING OF EACH KNOB

- Turn the volume control knob counterclockwise, to "0".
- Set the rotary knob to "flat".
- Set SOURCE DIRECT and LOUDNESS to "OFF ()".

After checking the above items, turn on the power, the amplifier is set in the ready mode in a few seconds.

PLAYING A RECORD

1. Set the INPUT SELECTOR switch to "PHONO".
2. Operate the turntable and play the record.
3. Turn the volume and tone controls to yield an appropriate volume and sound quality.

PLAYBACK OF CD PLAYER

1. Set the INPUT SELECTOR switch to "CD".
2. Operate the CD player.
3. Turn the volume and tone controls to yield an appropriate volume and sound quality.

RECEPTION OF RADIO PROGRAMS

1. Set the INPUT SELECTOR switch to "TUNER".
2. Operate the tuner to receive a radio program.
3. Turn the volume and tone controls to yield an appropriate volume and sound quality.

CONNECTIONS OF AUDIO EQUIPMENT TO AUX TERMINALS

1. Set the INPUT SELECTOR switch to "AUX" Position.
2. Operate the Audio equipment Systems.
3. Turn the volume and tone controls to yield an appropriate volume and sound quality.

PLAYBACK WITH TAPE DECK

1. Set the INPUT SELECTOR switch to "DAT/TAPE-1" or "DAT/TAPE-2".
2. Operate the Tape Deck.
3. Turn the volume and tone controls to yield an appropriate volume and sound quality.

RECORDING WITH TAPE DECK

1. Set the REC OUT SELECTOR to the program source you wish to record.
2. Start the playback of the program source.
3. Start recording with the component connected to "DAT/TAPE-1" or "DAT/TAPE-2".
- In the PMA-915R/715R, the REC OUT signal and the speaker (headphone) signal are output via separate circuits so that knobs and switches related to the tone and volume have no effect whatsoever on the sound that is recorded. Also, since the recording function is selected by the REC OUT SELECTOR, the free program source can be played through the speakers (or headphones) even during recording.

MONITORING THE RECORDING

A recording in progress can be monitored if a tape deck with three individual heads for recording and playback is used. A tape deck in which a common head is used for both recording and playback cannot be used to monitor recording. When a recording is being made using DAT/TAPE-1, selecting DAT/TAPE-1 with the INPUT SELECTOR will engage the RECORDING MONITOR and permit a check of the recording condition.

CAUTION

Protective Circuit
This set is equipped with a high speed protective circuit. This circuit protects the internal circuitry from damage due to large currents flowing when the speaker jacks are not completely connected or when an output is generated by a short circuit. This protective circuit's operation cuts off the output to the speakers. In such a case, be sure to turn the power to the set off and check the connections to the speakers. Then turn the power on again. After muting for several seconds, the set will operate normally.

NOTE

- This amplifier has a full memory back-up system. When the power is turned on, INPUT SELECTOR () are set to the last mode set before the power was turned off.

REMOTE CONTROL OPERATION

The accessory Remote Control Unit is used to control the amplifier from a convenient distance.

(1) Inserting the Dry Cell Batteries

1. Remove the battery cover on the Remote Control Unit.

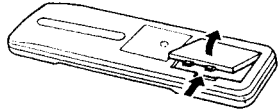

2. Insert two dry cell batteries as shown in the diagram on the battery supply unit.

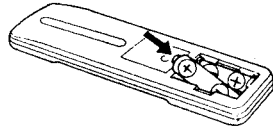

3. Replace the battery cover.

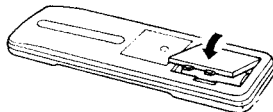

(2) Directions for use

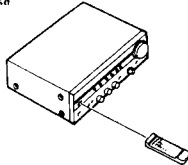

Notes on Battery Usage

- RC-176 uses the size R6P (AA) dry cell batteries.
- The batteries will need to be replaced approximately once a year. This will depend upon how often the Remote Control Unit is used.
- If, in less than a year from the time new batteries were inserted, the Remote Control Unit fails to operate the Amplifier from a near-by position, it is time to replace the batteries.
- Insert the batteries properly, following the polarity diagram inside the battery compartment.
- Batteries are prone to damage and leakage. Therefore:
 - Do not mix new batteries with used ones.
 - Do not mix different types of batteries.
 - Do not jumper opposite poles of the batteries, expose them to heat, break them open, nor expose them to open fire.
- If the batteries have leaked, remove any traces of battery fluid from the battery compartment wiping thoroughly with a dry cloth. Then insert new batteries.

- Operate the Remote Control Unit while pointing it towards the Remote Control Sensor on the Amplifier as shown in the diagram on the left.
- The Remote Control Unit can be used at distances up to about 8 meters in a straight line from the amplifier. This distance will decrease if there are obstructions blocking the infra-red light transmission or if the Remote Control Unit is not directed straight at the amplifier.

Note on operation

- Do not press the operating buttons on the Amplifier and the Remote Control Unit at the same time. This will cause misoperation.
- Operation of the Remote Control Unit will become less effective or erratic if the infrared Remote Control Sensor on the Amplifier is exposed to strong light or if there are obstructions between the Remote Control Unit and the sensor.
- In case you operate a VCR, TV or other components by remote control, do not operate buttons on two different remote control units at the same time. This will cause misoperation.

Besides being able to operate the PMA-915R/715R amplifier with this Remote Control Unit, you can also operate a DENON cassette deck and CD player from this handy full-system Remote Control Unit.

Remote control section

Full-system Remote Control Unit

The full-system Remote Control Unit operates all major functions of the Amplifier, such as function switching, volume control. But that's not all! The same control pad can also control the major functions of a DENON CD player and cassette deck and tuner when combined with the PMA-915R/715R to create a remarkably ergonomic and versatile DENON system with all the quality sound reproduction that the devoted audiophile expects.

Remote Control Unit RC-176 supplied with the PMA-915R/715R

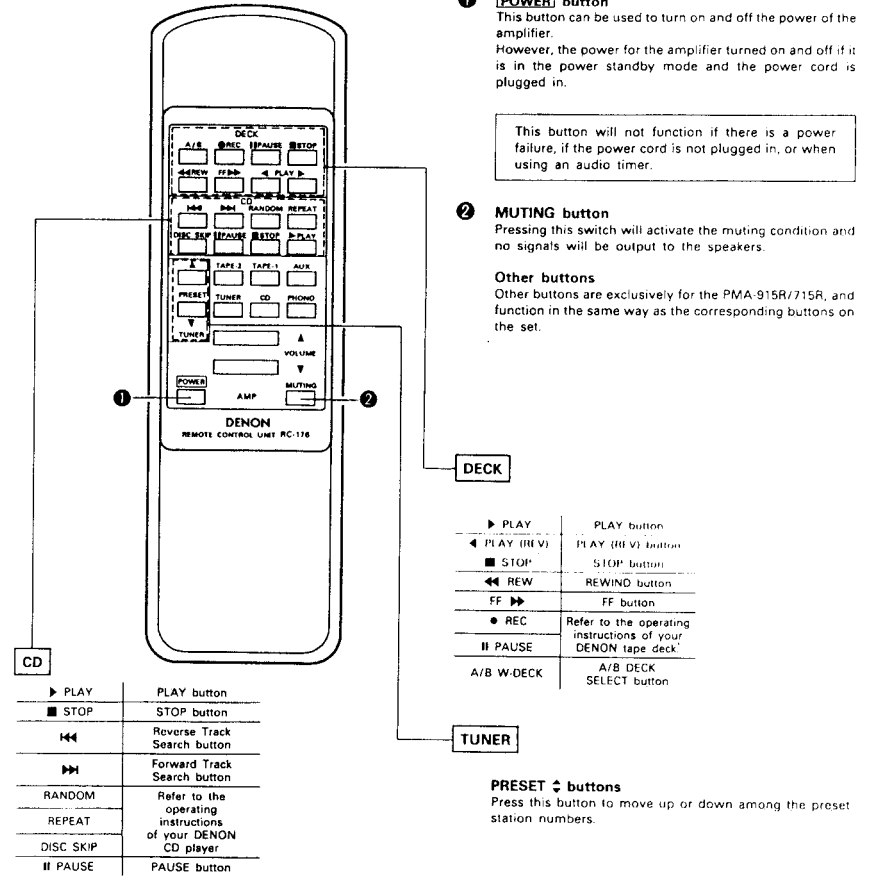

- The RC-176 Remote Control Unit can control CD players and cassette decks manufactured by DENON.
- Note that operation may not be possible for some models.
- Buttons are conveniently separated into groups, each group controlling one specific component. The groups are AMP, FUNCTION, CD, DECK and TUNER etc.

For details on operating other components, refer to the operating instructions for the CD player and/or cassette deck.

CAUTION:

- If the power is turned off with the Remote Control Unit, the set is switched to the power stand-by state. If you are absent for a long period of time, unplug the power cord.
- Only the MUTE/STANDBY LED Ⓞ lights when in the power stand-by mode.
- You may experience erratic operation of the Remote Control Unit if it is operated in fluorescent light and direct sunlight, in particular if this light strikes the Remote Control Sensor on the Amplifier. However, this is not a malfunction, and if this should happen, simply protect the sensor against such light.

Technical Data (typical value)	Technische Daten (typische Werte)	Caractéristiques techniques (valeur caractéristique)	PMA-915R/715R
POWER AMPLIFIER SECTION Rated Output Power: *Both channel driven (8 ohm Load) 20 Hz to 20 kHz, T.H.D. 0.02%/0.05% (4 ohm Load) DIN, 1 kHz, T.H.D. 0.7% *Continuous 80W/65W per channel max into 8 ohms from 20 Hz to 20 kHz with no more than 0.02%/0.05% total harmonic distortion. Total Harmonic Distortion: (-3 dB at rated output, 8 ohms)	LEISTUNGSENDEN VERSTÄRKER Nenn-Ausgangsleistung: *Beide Kanäle betriebsbereit (an 8 Ohm) 20 Hz bis 20 kHz, T.H.D. 0,02%/0,05% (an 4 Ohm) DIN, 1 kHz, T.H.D. 0,7% *Fortlaufend 80W/65W pro Kanal max. zu 8 Ohm von 20 Hz bis 20 kHz mit einem Gesamtklirrfaktor von nicht mehr als 0,02%/0,05%. Gesamtklirrfaktor: (-3 dB bei Nennausgang, 8 Ohm)	PARTIE AMPLIFICATEUR DEPUISSANCE Puissance nominale: *Entraînement deux canaux (charge 8 ohms) 20 Hz à 20 kHz, D.H.T. 0,02%/0,05% (charge 4 ohms) DIN, 1 kHz, D.H.T. 0,7% *80W/65W en continu par canal sur min. 8 Ohms de 20 Hz à 20 kHz avec une distorsion harmonique totale de 0,02%/0,05% ou moins. Distorsion harmonique totale: (-3 dB à la sortie nominale, 8 ohms)	80W + 80W/65W + 65W 130W + 130W/100W + 100W 80W/65W
PRE-AMPLIFIER SECTION Rated Output: (Recut Terminal) Input Sensitivity/ Input Impedance: The value in parentheses () refers to the input impedance when SOURCE DIRECT is ON. PHONO: CD, TUNER, AUX TAPE-1, TAPE-2 RIAA Deviation: PHONO Within ±0.3 dB Maximum Input:	VORVERSTÄRKER Nenn-Ausgangsleistung: (Aufnahme-Ausgangsbuchse) Eingangsempfindlichkeit/ Eingangsimpedanz: Der in Klammern () angegebene Wert bezieht sich auf die Eingangsimpedanz, wenn der Quellen-Direktschalter (SOURCE DIRECT) eingeschaltet (ON) ist. PHONO: CD, TUNER, AUX TAPE-1, TAPE-2 Abweichung von der RIAA-Kennlinie: PHONO Innerhalb ±0,3 dB Maximaler Eingang:	PRE-AMPLI Puissance nominale: (Borne de sortie d'enregistrement) Sensibilité d'entrée/ Impédance d'entrée: Le valeur entre parenthèses () se rapporte à l'impédance d'entrée lorsque le touche de source directe (SOURCE DIRECT) est sur la position sous tension (ON). PHONO: CD, TUNER, AUX TAPE-1, TAPE-2 Variation RIAA: PHONO: Int. ± ±0.3 dB Entrée max.:	150 mV MM 2.5 mV/47 kohm MC 200 µV/100 kohm 150 mV/47 kohm (150 mV/10 kohm) 20 Hz ~ 20 kHz PHONO MM 160 mV/1 kHz MC 12mV/1 kHz
OVERALL CHARACTERISTICS SN Ratio (IHF A Network): (input terminals short-circuited) SOURCE-DIRECT: ON Tone Control Adjustable Range: BASS TREBLE Loudness:	GESAMTEIGENSCHAFTEN Signal/Rauschabstand (IHF-A-Weichte): (Eingänge kurzgeschlossen) SOURCE DIRECT: ON Klangregelbereich: TIEFFEN (BASS) HOHEN (TREBLE) Gehörliche Lautstärke:	CARACTERISTIQUES GENERALES Rapport signal/bruit (réseau IHF A): (Bornes d'entrée court-circuitées) SOURCE DIRECT: ON Gamme de réglage de tonalité: GRAVES AIGUS Compensation physiologique:	PHONO: MM: 94 dB (at 5 mV input) MC: 76 dB (at 0.5 mV input) CD, TUNER, AUX TAPE-1, TAPE-2: 110 dB 100 Hz ±8 dB 10 kHz ±8 dB 100 Hz ±7 dB 10 kHz ±6 dB
OTHERS Power Supply AC Outlets Switched x2: Unswitched x1: Power Consumption Dimensions (W) x (H) x (D) Net Weight REMOTE CONTROL UNIT (RC-176) Remote control system: Infrared pulse system Power supply: 3V DC, two size R6P ("AA") dry cell batteries External dimensions: Weight:	SOMSTIGES Netzspannung und -frequenz Wechselstrom-Ausgänge Geschaltet x2: Ungeschaltet x1: Leistungsaufnahme Abmessungen (B) x (H) x (T) Nettogewicht FERNBEDIENUNGSGERÄT (RC-176) Fernbedienungs-System: Infrarot-Impulse Stromversorgung: 3V Gleichstrom, zwei Trocken-zelle-Batterien vom format R6P (AA) Außere Abmessungen: Gewicht:	AUTRES Alimentation Prises secteur (AC) Commutées x2: Non commutées x1: Consommation Dimensions (L) x (H) x (D) Poids UNITE DE TELECOMMANDE (RC-176) Système de télécommande: Système à impulsion infrarouge Alimentation: 3V CC, deux piles sèches de format R6P ("AA") Dimensions extérieures: Poids:	AC230V/50 Hz (For Europe and Australia) AC120V/60 Hz (For U.S.A. and Canada) AC110/220/230V, 50/60 Hz (For Multiple) 100W (Total) (For Europe and Multi-Voltage models, except the U.K. model) 120W (Total) (For U.S.A. and Canada models) 100W (For Europe and Multi-Voltage models, except the U.K. model) 240W (For U.S.A. and Canada models) 230W/210W (IEC) 42x52.6x112 (U.S.A. and Canada models) 434(W)x160(H)x251(D)mm PMA-915R (17-3/32" x 6-19/64" x 13-13/16") 434(W)x140(H)x251(D)mm PMA-715R (17-3/32" x 5-11/2" x 13-13/16") 9.0 kg (19 lbs 14 oz) / 8.2 kg (18 lbs 2 oz) 55(W)x194(H)x18(D)mm (2-11/64" x 7-41/64" x 45/64") 100 g (about 3.5 oz) (including batteries)

ENGLISH

Please check to make sure the following items are included with the main unit in the carton:

- (1) Operating Instructions 1
- (2) Remote Control Unit (RC-176) 1
- (3) Batteries R6P (AA) 2

DEUTSCH

Bitte überprüfen Sie, ob die folgenden Teile vollständig in der Verpackung enthalten sind:

- (1) Bedienungsanleitung 1
- (2) Fernbedienung (RC-176) 1
- (3) Batterien vom Typ R6P (AA) 2

FRANCAIS

Veillez contrôler que les articles suivants sont bien joints à l'appareil principal dans le carton:

- (1) Mode d'emploi 1
- (2) Unité de télécommande (RC-176) 1
- (3) Piles R6P (AA) 2

ITALIANO

Controllare che le parti seguenti si trovino imballate con l'apparecchio nella scatola di spedizione.

- (1) Libretto delle istruzioni 1
- (2) Telecomando (RC-176) 1
- (3) Batterie R6P (AA) 2

ESPAÑOL

Por favor verifique asegurándose de que los siguientes artículos son empacados en la caja pero separados de la unidad principal.

- (1) Manual de instrucciones 1
- (2) Unidad de control remoto (RC-176) 1
- (3) Pilas R6P (AA) 2

NEDERLANDS

Kontroleer of de volgende accessoires bij het hoofdtoestel in de doos zijn verpakt:

- (1) Gebruiksaanwijzing 1
- (2) Afstandsbediening (RC-176) 1
- (3) Batterijen R6P (AA) 2

SVENSKA

Kontrollera att följande, förutom huvudapparat, finns med i kartongen.

- (1) Bruksanvisning 1
- (2) Fjärrkontroll (RC-176) 1
- (3) Batterier R6P (AA) 2

PORTUGUÊS

Certifique-se de que as seguintes peças estão incluídas na embalagem fora da unidade principal:

- (1) Instruções de operação 1
- (2) Unidade de controle remoto (RC-176) 1
- (3) Baterias R6P (AA) 2

Note: *1 For Europe and Multi-Voltage *2 For U.S.A. and Canada Hinweis: *1 Für Europe und Mehrspannung *2 Für die USA und Kanada Note: *1 Pour les modèles pour l'Europe et multi-tension *2 Pour les U.S.A. et le Canada

Specifications and contents are subject to change without notice for purposes of improvement.
 Änderungen des Inhalts und der technischen Daten zum Zwecke der Verbesserung vorbehalten.
 Specifications et contenu sont sujets à modification sans préavis.

REMOVAL OF EACH SECTION

1. Top Cover

- (1) Remove 4 screws (A), and 3 screws (B).
- (2) Pull up Top Cover in arrow direction.

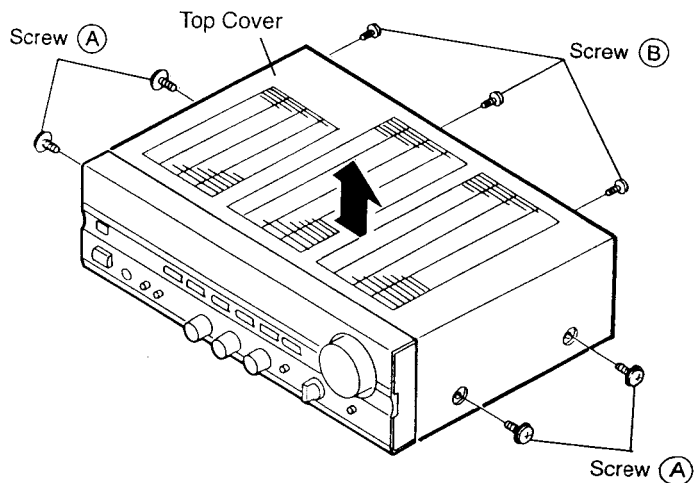

2. Front Panel

- (1) Detach Control Knob and Nut.
- (2) Remove 3 screws (C).
- (3) Remove 4 screws (D).
- (4) Detach Front Panel in arrow direction.

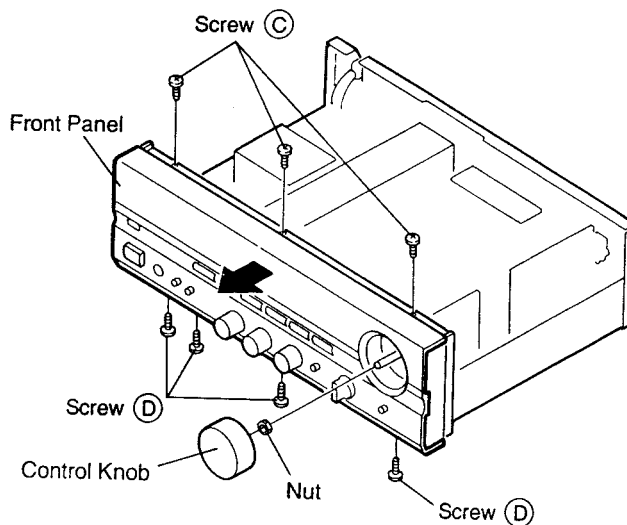

3. Inner Panel

- (1) Detach 4 Knobs and 3 nuts.
- (2) Remove 2 screws (E).
- (3) Remove 2 screws (F).
- (4) Detach Inner Panel in arrow direction.

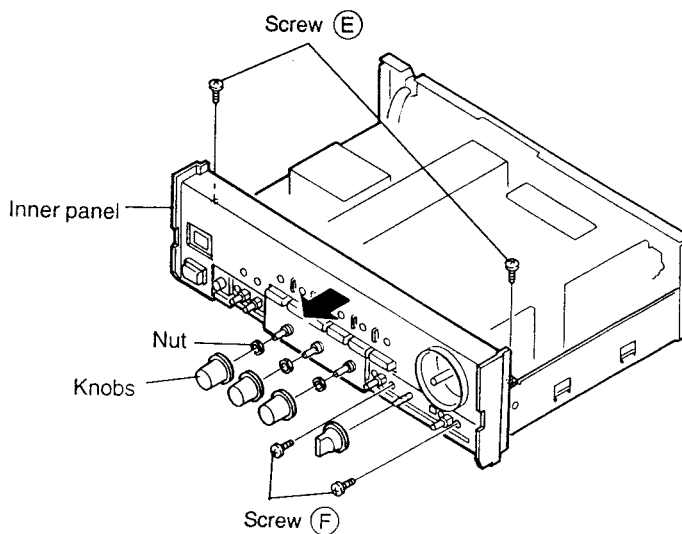

4. P.W. Board attached to Inner Panel

- (1) Remove 6 screws (G) .
- (2) Take out P.W. Board in arrow direction.

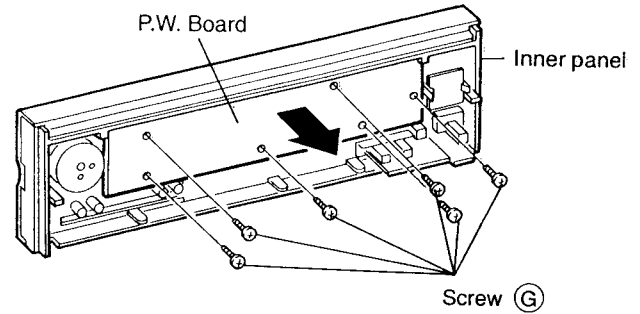

5. Main Chassis

- (1) Remove 2 screws (H) .
- (2) Remove 4 screws (I) .
- (3) Remove 2 screws (J) .
- (4) Remove 4 screws (K) .

Note: Then, by pulling up, FRONT PANEL, POWER RADIATOR, P.W.B., REAR PANEL will be detached as a whole. However, wire on POWER TRANS still remains connected; therefore make repairing on detached CHASSIS side-up.

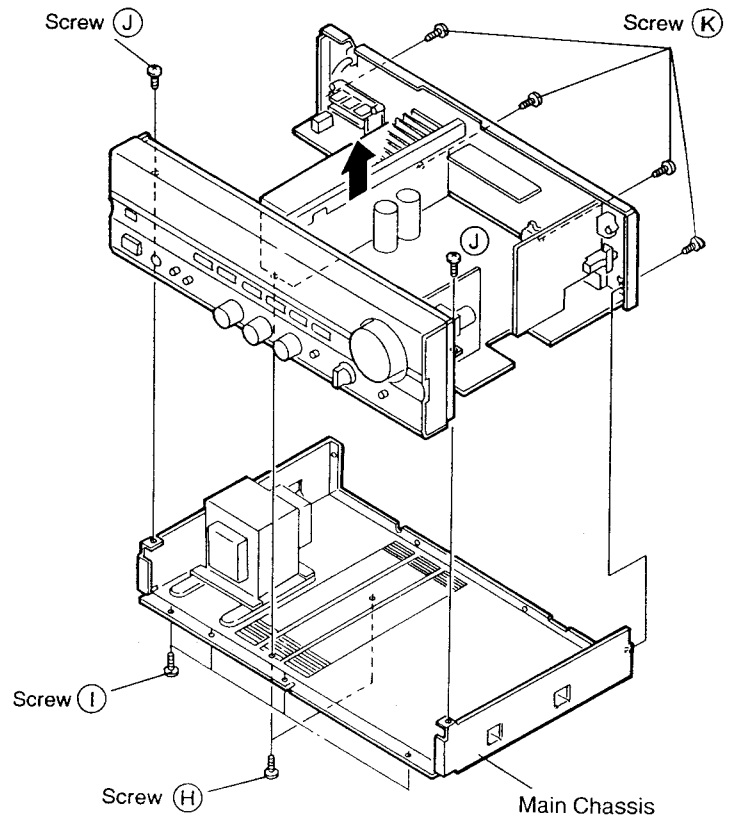

FUNCTION OF NEW CIRCUIT

1. CHARACTERISTIC OF THIS CIRCUIT

The junction temperature of power amplifier output transistor always varies by an ambient temperature and music signal. Occurrence of junction temperature varying causes in change of bias current, unstable function, thus pure music signal playback is unable to do.

To maintain fixed bias current and to make pure music signal playback possible is the purpose of this circuit. This circuit holds stable bias current condition within a few seconds after turning on the power.

2. BLOCK DIAGRAM OF BIAS CONTROL CIRCUIT FUNCTION

As explained in Fig. 1, detects a voltage across the emitter resistors (RE) of TR1, TR2. Converts the detected voltage and comparing with the reference voltage to make the bias current value in stable state. Actually, these functions are performed by 1 chip IC.

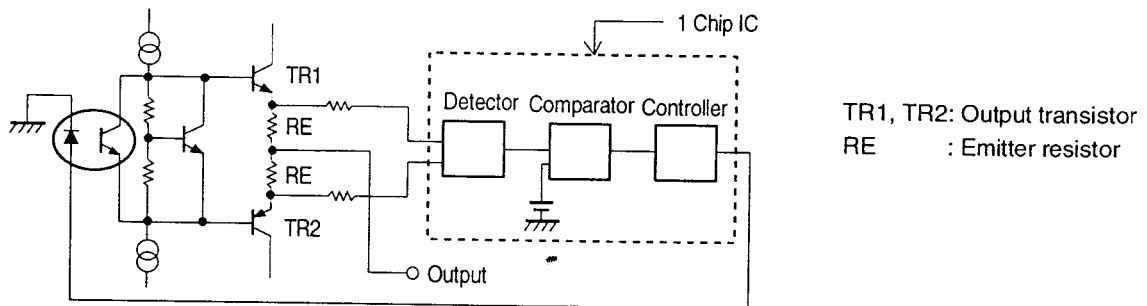

Fig. 1

3. POWER SUPPLY FOR ACTUATING CONTROL CIRCUIT

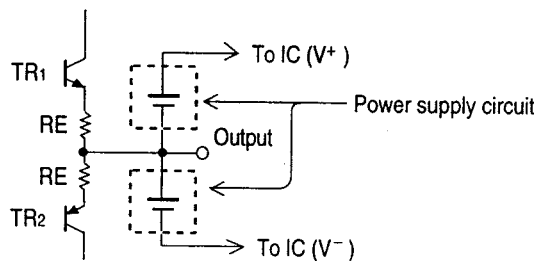

Fig. 2

The circuit (IC) controlling bias current actuates by floating.

Accordingly, the power supply is also needed to be floated.

In this circuit, as indicated in Fig. 2, output is common to provide +, - power system and supplies to IC.

4. IC DESCRIPTION (μ PC5023CS-064)

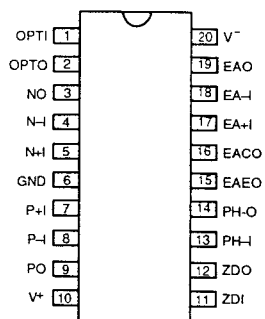
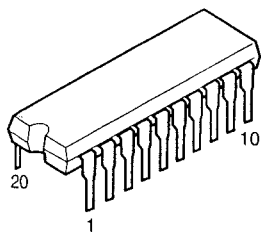

Pin. No.	Name	Contents
1	OPTI	NCP
2	OPTO	
3	NO	Comparator output
4	N-I	Comparator input (-)
5	N+I	Comparator input (+)
6	GND	Floating common
7	P+I	Comparator input (+)
8	P-I	Comparator input (-)
9	PO	Comparator output
10	V+	+ Power supply

Pin. No.	Name	Contents
11	ZDI	Control signal stabilizer input
12	ZDO	Control signal stabilizer output
13	PH-I	Peak hold input
14	PHO	Peak hold output
15	EAE0	Controller gain setting
16	EACO	Control signal output
17	EA+I	Reference voltage
18	EA-I	Comparator gain setting
19	EAO	Comparator output
20	V-	- Power supply

5. CIRCUIT IN THE CONCRETE

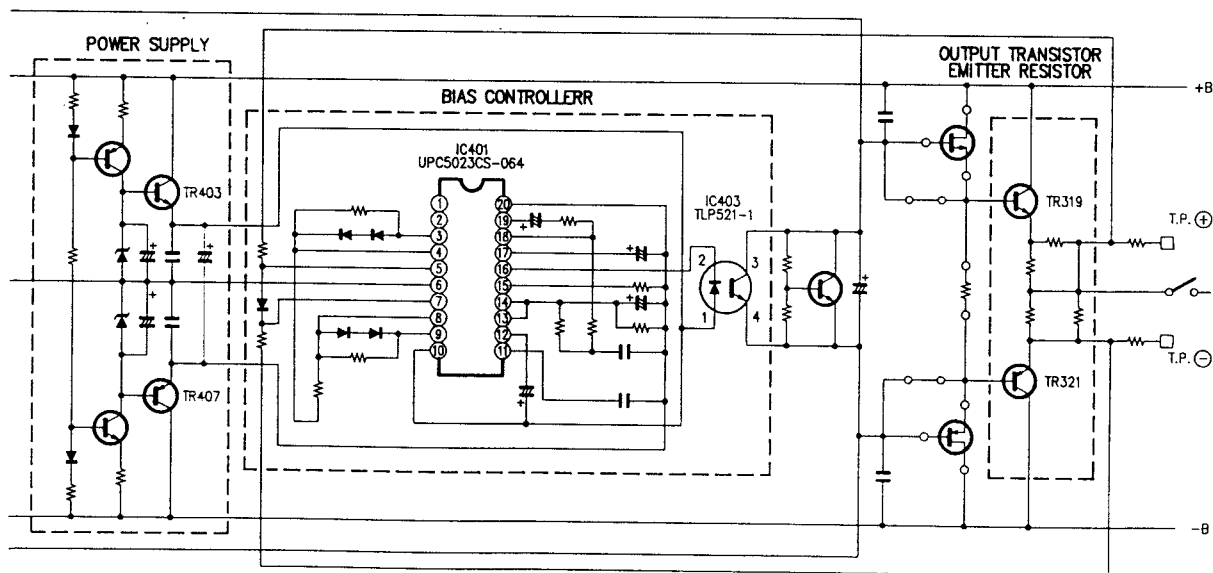

METHOD OF ADJUSTMENTS

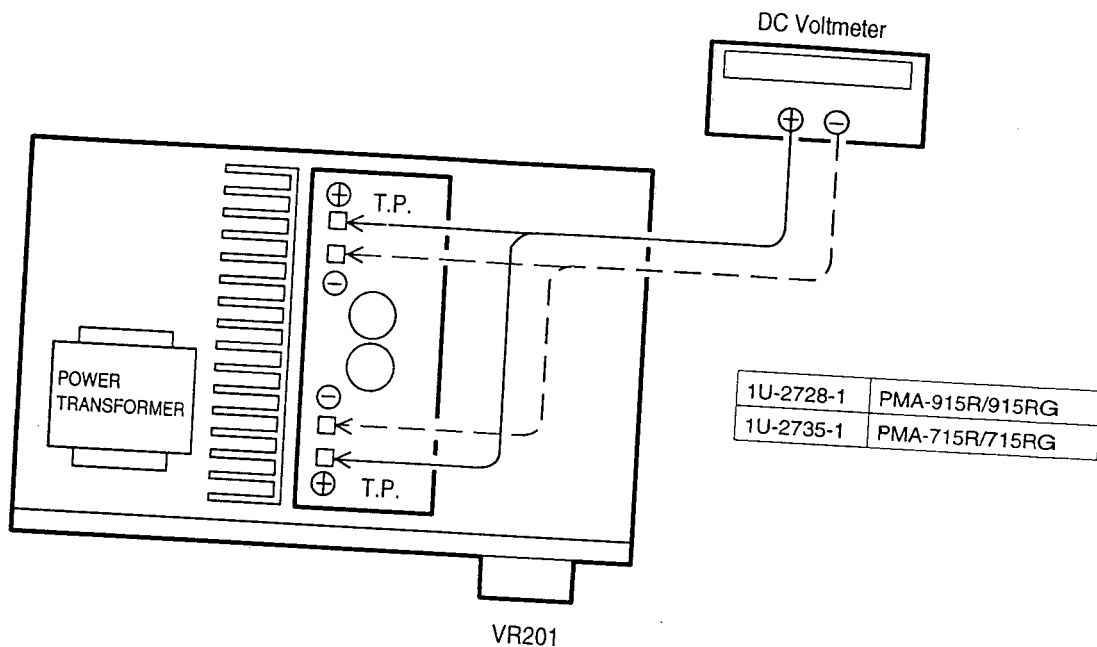

IDLING CURRENT

● Setup

1. Lay the unit at an ordinary position away from a direct current from a cooler or fan. Do the adjustment at a temperature between 15°C (59°F) and 30°C (86°F).
2. Set controls as follows.
POWER SWITCH → OFF (■)
VOLUME CONTROL → fully counterclockwise. (⤵) min.
SPEAKER Terminals → open: do not connect the speakers, dummy load etc.

● Confirm

1. Remove Top cover. And then connect DC Voltmeter to Test points of Main Unit 1U-2728-1 (PMA-915R/915RG) or 1U-2735-1 (PMA-715R/715RG).
2. Connect Power cord to AC Outlet, and turn POWER Switch "on" (■).
3. 10 seconds after check to see DC Voltmeter reading is $8 \pm 5\text{mV}$.
4. 2 minutes after re-check DC Voltmeter for $8 \pm 5\text{mV}$ reading.

BLOCK AND LEVEL DIAGRAM

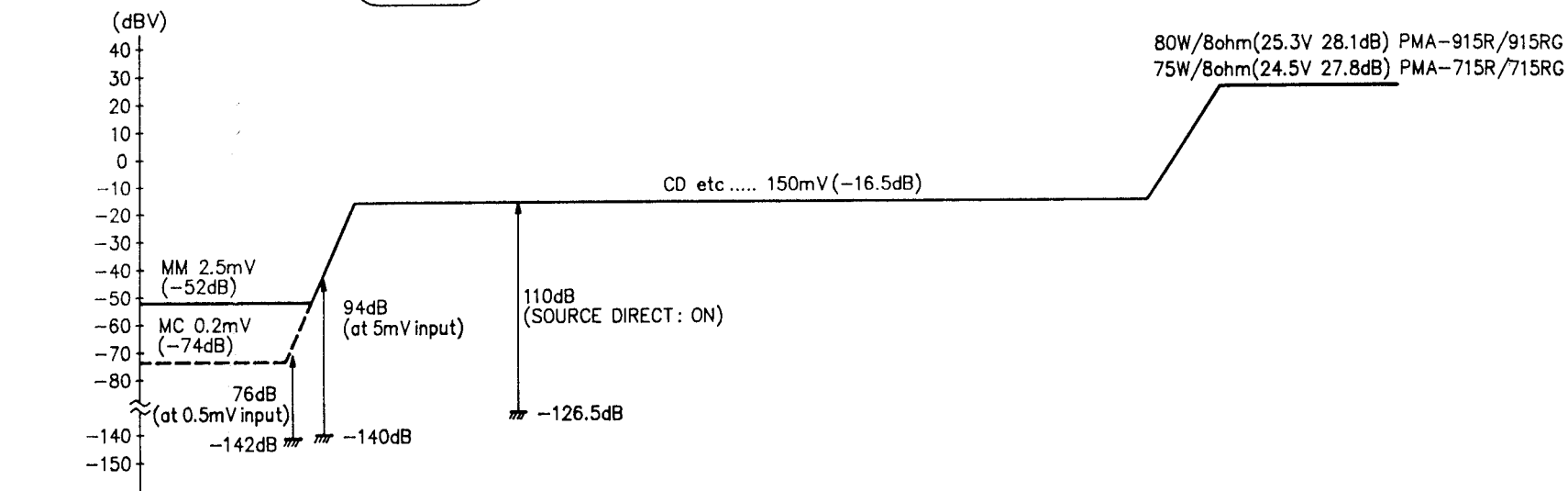
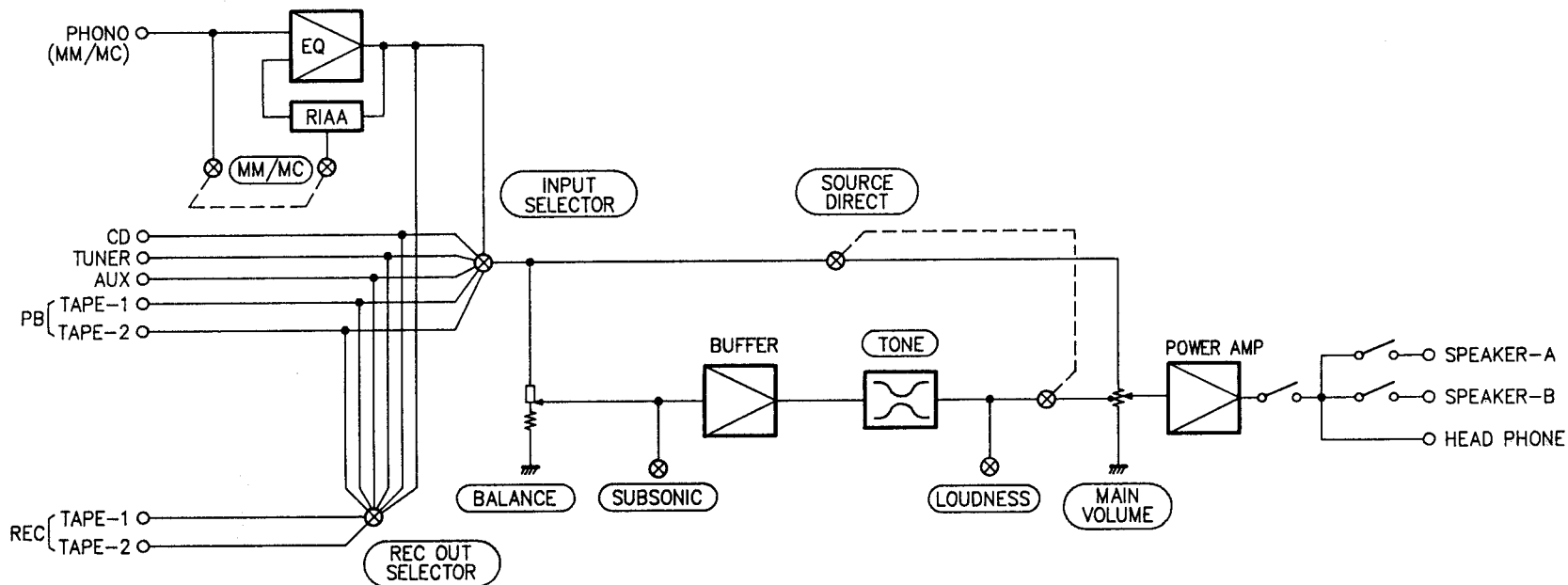

SEMICONDUCTORS

● IC's

μPC5023CS-064 (IC401,402)

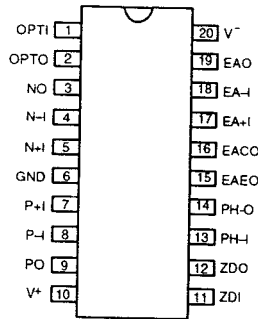
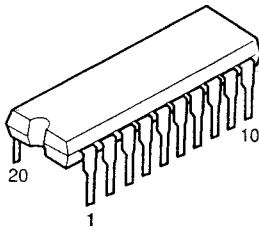

Pin. No.	Name	Contents
1	OPTI	NCP
2	OPTO	
3	NO	Comparator output
4	N-I	Comparator input (-)
5	N+I	Comparator input (+)
6	GND	Floating common
7	P+I	Comparator input (+)
8	P-I	Comparator input (-)
9	PO	Comparator output
10	V+	+ Power supply

Pin. No.	Name	Contents
11	ZDI	Control signal stabiliser input
12	ZDO	Control signal stabiliser output
13	PH-I	Peak hold input
14	PHO	Peak hold output
15	EAEO	Controller gain setting
16	EACO	Control signal output
17	EA+I	Reference voltage
18	EA-I	Comparator gain setting
19	EAO	Comparator output
20	V-	- Power supply

HD404304A13P (IC801)

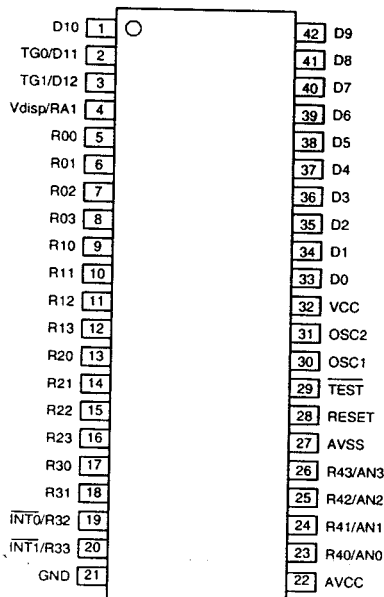

HD404304P Terminal Function

Pin No.	Name	I/O	Contents	Active
1	D10	O	VOLUME LED Indication	H
2	TG0/D11	O	NCP	
3	TG1/D12	O	Power Control (REMOTE Power-ON/OFF)	L
4	Vdisp/RA1	I	NCP	
5	R00	O	NCP	
6	R01	O	Muting Control (Power ON-OFF, Function Shifting, Muting)	L
7	R02	O	SP-A Control	H
8	R03	O	SP-A Control	H
9	R10	O		H
10	R11	O	Key scan strobe	H
11	R12	O		H
12	R13	O	NCP	H
13	R20	I		
14	R21	I	Key scan receive	
15	R22	I		
16	R23	I		
17	R30	O	Volume Control "UP" → "H"	H
18	R31	O	Volume Control "DOWN" → "H"	H
19	INT0/R32	I	Power Breakdown detect input	
20	INT1/R33	I	Remote control signal decoding input	
21	GND		GND	
22	AVcc		AVcc (Vcc)	
23	R40/AN0		NCP	
24	R41/AN1	I	NCP	
25	R42/AN2	I	NCP	
26	R43/AN3	I	Discrimination port by user's genre	
27	AVss		AVss (GND)	
28	RESET		MS1954A; External	
29	TEST		Vcc	
30	OSC1		Center Fill Oscillator 4MHz; External	
31	OSC2		Center Fill Oscillator 4MHz; External	
32	Vcc		Vcc	
33	D0	O	SC-RCE DIRECT Control	H
34	D1	O	NCP	
35	D2	O	TAPE-2 Control	H
36	D3	O	TAPE-1 Control	H
37	D4	O	NCP	
38	D5	O	FAV Control	H
39	D6	O	TUNER Control	H
40	D7	O	NCP	
41	D8	O	CD Control	H
42	D9	O	FM-CH0 Control	H

M51954A (IC803)

BA4558 (IC201, 901) M5219P

NJM7806FA(S) (IC702)

TRP521-1(BL) INFRARED LED + PHOTO TRANSISTOR

LB1639 (IC802)

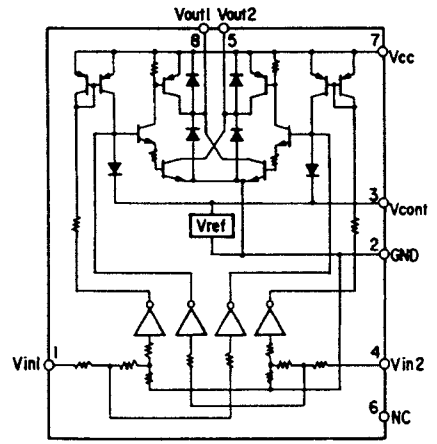

IC PROTECTOR ICP-N15 (IC701)

SBX1610-52 (Remote Control Receiver)

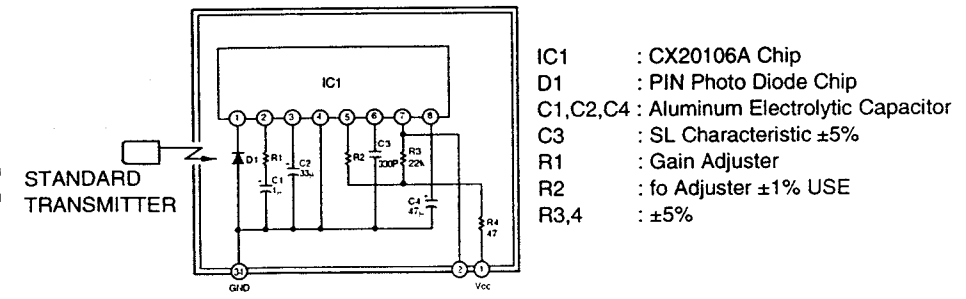

TRANSISTORS

**2SA970 (BL), (BL/GR)
 2SA988 (E/F)
 2SC1841 (E/F)**

**2SA1145 (O)/(Y)
 2SC2705 (O)/(Y)**

**PMA-915R
 2SA1491 (O/P/Y)(Z)
 2SC3855 (O/P/Y)(Z)**

**PMA-715R
 2SB1560 (O/P/Y)
 2SD2390 (O/P/Y)**

**2SA1038 (S/E)
 2SC1740S (S)
 2SA933S (S)
 2SC2389S (S/E)**

RN2202 PNP

	R1	R2
RN2204	10kohm	10kohm

**2SJ78
 2SK215**

**2SD1762 (E/F)
 2SB1185 (E/F)**

2SK184C (GR)/(RL)

2SK369

DIODES (including LED)

1SS252

**MTZJ3.9A MTZJ18A
 MTZJ7.5A MTZJ36A
 MTZJ16A**

**4D4B42 (LC1)(D702): PMA-915R/915RG
 S4VB20F (D702): PMA-715R/715RG**

**SEI-1810A (Orange)
 SEL-1210S (Red)**

Thyristor SFOR1A42 (SC601)

1SR35-200A

PRINTED WIRING BOARD (Pattern Side)

1 2 3 4 5 6 7 8

1U-2728 MAIN UNIT ASS'Y: PMA-915R/915RG

MAIN UNIT ASS'Y	
-1	Main Unit
-2	S.P. Switch Unit
-3	S.P. Terminal Unit
-4	16V Unit

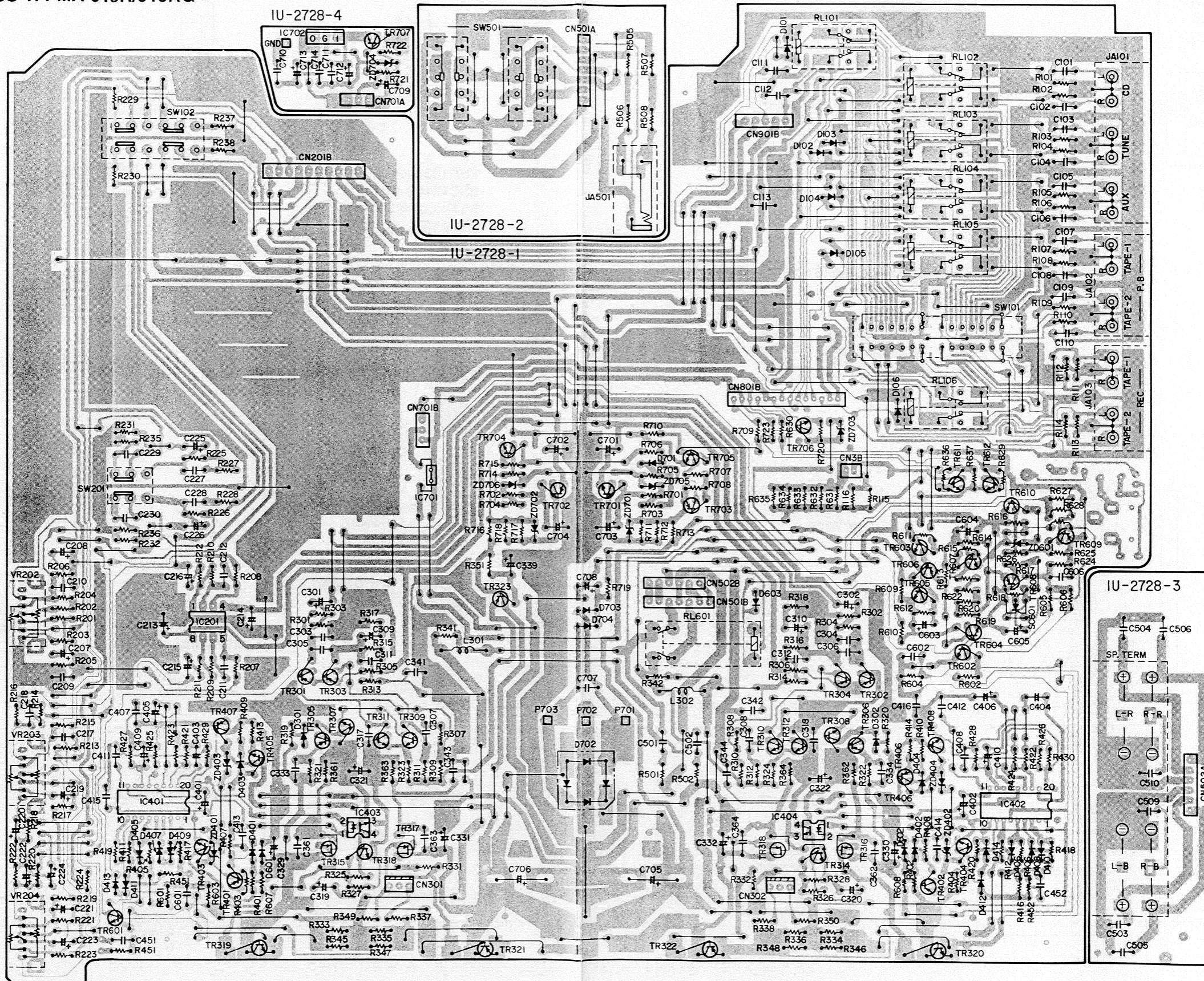

Version	Unit No.	H/P Jack	SP Terminal
Black for Europe	1U-2728A	203 8354 004	203 0484 001
Gold for Europe	1U-2728B	203 8355 003	203 0484 001
U.S.A.	1U-2728D	203 8354 004	203 0632 002
Canada	1U-2728D	203 8354 004	203 0632 002
Multi-Voltage	1U-2728G	203 8354 004	203 0472 013

*

1 2 3 4 5 6 7 8

1U-2729 CONTROL UNIT ASS'Y: PMA-915R/915RG

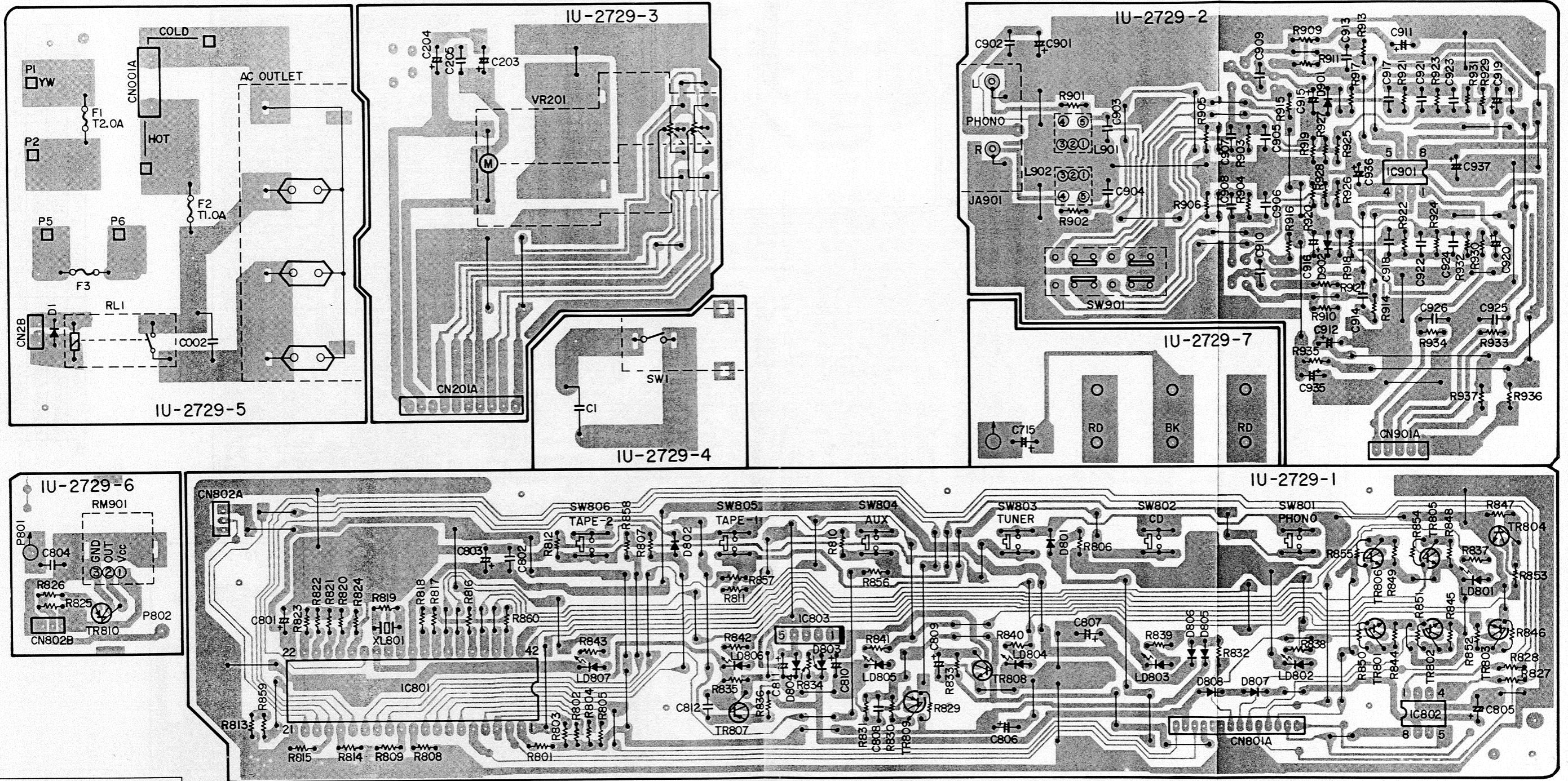

CONTROL UNIT ASS'Y	
-1	μ-Com. Unit
-2	Phono EQ. Unit
-3	Main Vol. Unit
-4	Power Switch Unit
-5	AC Unit
-6	Remocon Sensor Unit
-7	P.T. Unit

* Version	Unit No.	L901, 902	R637, 638	F001	F002	F003	AC Outlet
Europe Black	1U-2729A	235 9003 002	820 ohm	T2.5A	T1A	—	203 3950 002
Europe Gold	1U-2729B	235 9003 002	820 ohm	T2.5A	T1A	—	203 3950 002
U.S.A., Canada	1U-2729D	—	Jumper	T6.3A	T8A	—	—
Multi-Voltage	1U-2729G	—	Jumper	T2.5A	T1A	T3.15A	—

A
B
C
D
E

1 2 3 4 5 6 7 8

1U-2735 MAIN UNIT ASS'Y: PMA-715R/715RG

MAIN UNIT ASS'Y	
-1	Main Unit
-2	S.P. Switch Unit
-3	S.P. Terminal Unit
-4	16V Unit

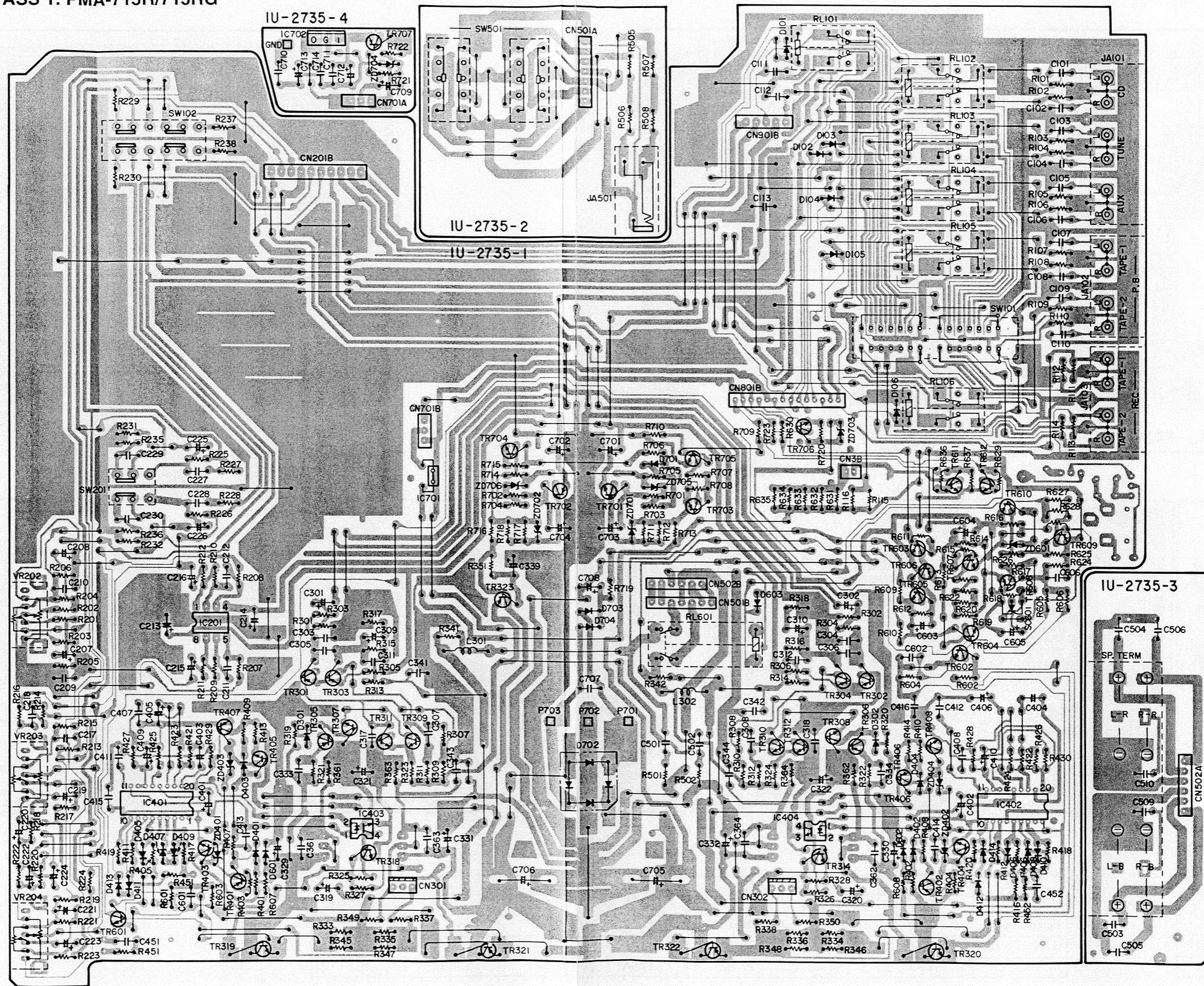

Version	Unit No.	H/P Jack	SP Terminal
Black for Europe	1U-2735A	203 8354 004	203 0484 001
Gold for Europe	1U-2735A	203 8355 003	203 0484 001
Multi-Voltage	1U-2735G	203 8354 004	203 0472 013
Australia, U.K.	1U-2735C	203 8354 004	203 0472 013

*

1 2 3 4 5 6 7 8

1U-2736 CONTROL UNIT ASS'Y: PMA-715R/715RG

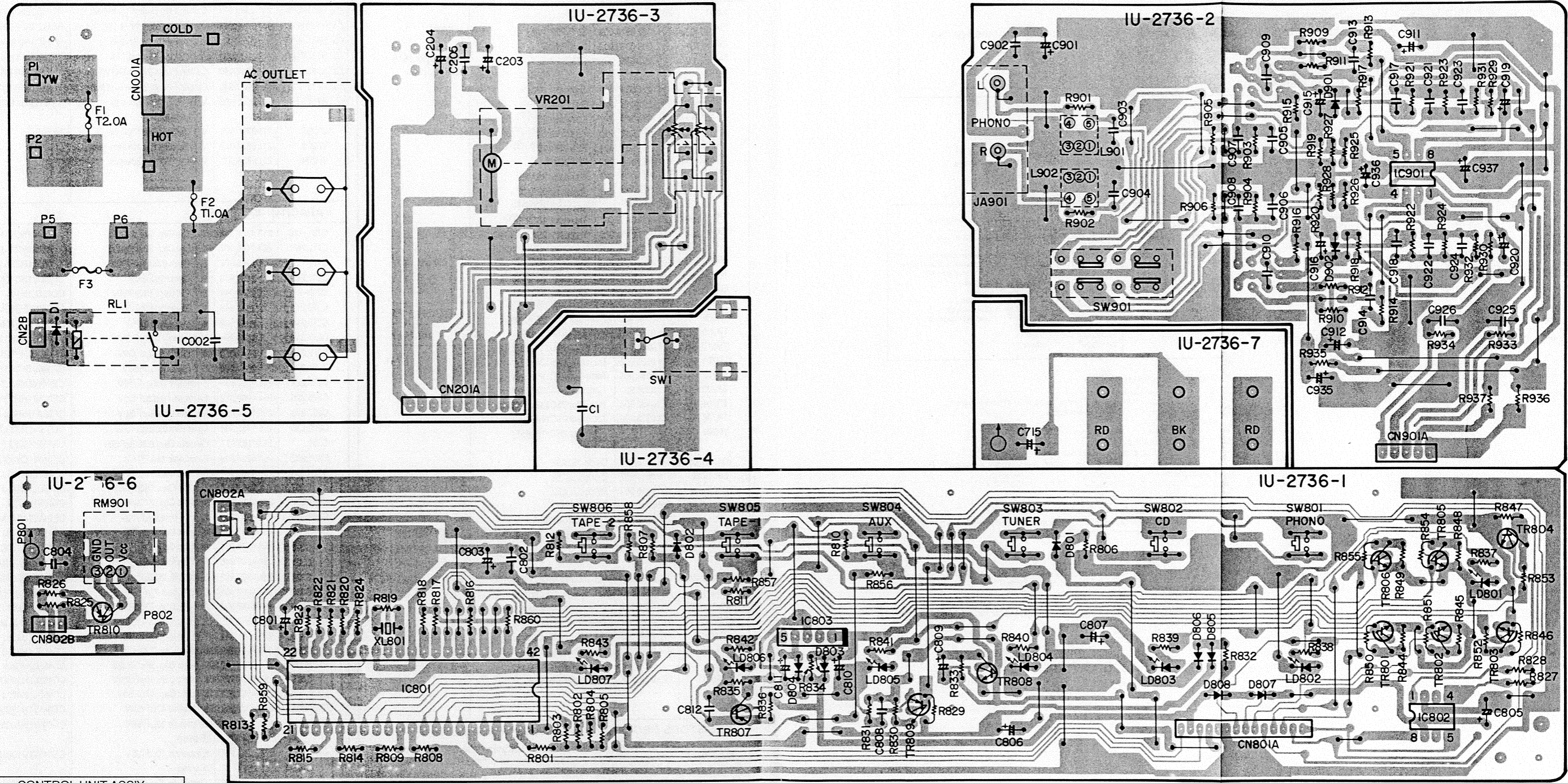

A
B
C
D
E

CONTROL UNIT ASS'Y	
-1	μ-Com. Unit
-2	Phono EQ. Unit
-3	Main Vol. Unit
-4	Power Switch Unit
-5	AC Unit
-6	Remocon Sensor Unit
-7	P.T. Unit

*	Version	Unit No.	L901,902	R637,638	F001	F002	F003
	Europe Black	1U-2736A	235 9003 002	820 ohm	2A	1AT	—
	Europe Gold	1U-2736B	235 9003 002	820 ohm	2A	1AT	—
	Multi-Voltage	1U-2736G	—	Jumper	2A	1AT	5A
	Australia, U.K.	1U-2736C	—	Jumper	2A	—	—

PARTS LIST OF P.W. BOARD: PMA-915R/915RG 1U-2728 A,B MAIN UNIT ASS'Y (for Europe Version)

NOTE FOR PARTS LIST

- Part indicated with the mark "⊙" are not always in stock and possibly to take a long period of time for supplying, or in some case supplying of part may be refused.
- When ordering of part, clearly indicate "1" and "I" (i) to avoid mis-supplying.
- Ordering part without stating its part number can not be supplied.
- Part indicated with the mark "★" is not illustrated in the exploded view.
- Not including Carbon Film ±5%, 1/4W Type in the P.W.Board parts list. (Refer to the Schematic Diagram for those parts.)

WARNING:

Parts marked with this symbol have critical characteristics.
Use ONLY replacement parts recommended by the manufacturer.

● Resistors

Ex.:

RN	14K	2E	182	G	FR
Type	Shape and performance	Power	Resistance	Allowable error	Others

RD : Carbon	2B : 1/8W	F : ±1%	P : Pulse-resistant type
RC : Composition	2E : 1/4W	G : ±2%	NL : Low noise type
RS : Metal oxide film	2H : 1/2W	J : ±5%	NB : Non-burning type
RW : Winding	3A : 1W	K : ±10%	FR : Fuse-resistor
RN : Metal film	3D : 2W	M : ±20%	F : Lead wire forming
RK : Metal mixture	3F : 3W		
	3H : 5W		

• Resistance

$\frac{1}{\text{---}} \frac{8}{\text{---}} \frac{2}{\text{---}} \Rightarrow 1800 \text{ ohm} = 1.8 \text{ kohm}$
Indicates number of zeros after effective number.
2-digit effective number.

• Units: ohm

$\frac{1}{\text{---}} \frac{R}{\text{---}} \frac{2}{\text{---}} \Rightarrow 1.2 \text{ ohm}$
1-digit effective number.
2-digit effective number, decimal point indicated by R.

• Units: ohm

● Capacitors

Ex.:

CE	04W	1H	2R2	M	BP
Type	Shape and performance	Dielectric strength	Capacity	Allowable error	Others

CE : Aluminum foil electrolytic	0J : 6.3V	F : ±1%	HS : High stability type
CA : Aluminum solid electrolytic	1A : 10V	G : ±2%	BP : Non-polar type
CS : Tantalum electrolytic	1C : 16V	J : ±5%	HR : Ripple-resistant type
CQ : Film	1E : 25V	K : ±10%	DL : For charge and discharge
CK : Ceramic	1V : 35V	M : ±20%	HF : For assuring high frequency
CC : Ceramic	1H : 50V	Z : +80%	U : UL part
CP : Oil	2A : 100V	-20%	C : CSA part
CM : Mica	2B : 125V	P : +100%	W : UL-CSA type
CF : Metallized	2C : 160V	-0%	F : Lead wire forming
CH : Metallized	2D : 200V	C : ±0.25pF	
	2E : 250V	D : ±0.5pF	
	2H : 500V	= : Others	
	2J : 630V		

• Capacity (electrolyte only)

$\frac{2}{\text{---}} \frac{2}{\text{---}} \frac{2}{\text{---}} \Rightarrow 2200\mu\text{F}$
Indicates number of zeros after effective number.
2-digit effective number.

• Units: μF.

$\frac{2}{\text{---}} \frac{R}{\text{---}} \frac{2}{\text{---}} \Rightarrow 2.2\mu\text{F}$
1-digit effective number.
2-digit effective number, decimal point indicated by R.

• Units: μF.

• Capacity (except electrolyte)

$\frac{2}{\text{---}} \frac{2}{\text{---}} \frac{2}{\text{---}} \Rightarrow 2200\text{pF} = 0.0022\mu\text{F}$
(More than 2) — Indicates number of zeros after effective number.
2-digit effective number.

• Units: pF.

$\frac{2}{\text{---}} \frac{2}{\text{---}} \frac{1}{\text{---}} \Rightarrow 220\text{pF}$
(0 or 1) — Indicates number of zeros after effective number.
2-digit effective number.

• Units: pF.

• When the dielectric strength is indicated in AC, "AC" is included after the dielectric strength value.

Ref. No.	Parts No.	Parts Name	Remarks
SEMICONDUCTORS GROUP			
IC201	265 0322 004	IC BA4558	
IC401,402	263 0930 001	IC μPC5023CS-064	μ-com
IC403,404	262 0874 009	IC TLP521-1(B)	
IC701	268 0073 905	IC ICP-N15	IC Protector 15 V
IC702	263 0793 002	IC NJM7806FA(S)	Regulator +6 V
TR301-304	271 0094 919	Transistor 2SA970(BL)	
TR305,306	271 0131 924	Transistor 2SA988(E/F)	
TR307-312	273 0235 923	Transistor 2SC1841(E/F)	
TR313,314	273 0303 910	Transistor 2SC1740S(S)	
TR315,316	275 0069 001	FET 2SK215	
TR317,318	275 0068 002	FET 2SJ78	
TR323	271 0131 924	Transistor 2SA988(E/F)	
TR401,402	271 0280 901	Transistor 2SA1038(S/E)	
TR403,404	273 0281 906	Transistor 2SC2705(O/Y)	
TR405,406	273 0432 904	Transistor 2SC2389S(S)	
TR407,408	271 0168 900	Transistor 2SA1145(O/Y)	
TR601,602	273 0235 923	Transistor 2SC1841(E/F)	
TR603-605	273 0303 910	Transistor 2SC1740S(S)	
TR606	271 0192 905	Transistor 2SA933S(S)	
TR607	273 0235 923	Transistor 2SC1841(E/F)	
TR608	271 0094 935	Transistor 2SA970(BL/GR)	
TR609	271 0131 924	Transistor 2SA988(E/F)	
TR610-612	273 0235 923	Transistor 2SC1841(E/F)	
TR701	274 0120 002	Transistor 2SD1762(E/F)	
TR702	272 0083 004	Transistor 2SB1185(E/F)	
TR703	271 0280 901	Transistor 2SA1038(S/E)	
TR704,705	273 0432 904	Transistor 2SC2389S(S/E)	
TR706	273 0303 910	Transistor 2SC1740S(S)	
TR707	274 0120 002	Transistor 2SD1762(E/F)	
D101-106	276 0616 907	Diode 1SS252	
D301,302	276 0616 907	Diode 1SS252	
D401-414	276 0616 907	Diode 1SS252	
D601-603	276 0616 907	Diode 1SS252	
D701	276 0553 905	Diode 1SR35-200A	
△ D702	276 0424 005	Diode 4D4B42 (LC1)	Bridge
D703,704	276 0553 905	Diode 1SR35-200A	
ZD401-404	276 0643 954	Zener Diode MTZJ3.9A	3.9 V
ZD601	276 0644 911	Zener Diode MTZJ7.5A	7.5 V
ZD701,702	276 0645 978	Zener Diode MTZJ36A	36 V
ZD703	276 0644 911	Zener Diode MTZJ7.5A	7.5 V
ZD704	276 0644 995	Zener Diode MTZJ16A	16 V
ZD705,706	276 0645 907	Zener Diode MTZJ18A	18 V
SC601	279 0016 904	Thyristor SF0R1A42	
RESISTORS GROUP (Not included Carbon Film ±5%, 1/4 W Type. Refer to the Schematic Diagram for those parts.)			
△ R115	244 2052 957	Metal Oxide 5.6kohm 1 W	RS14B3A562JNBS(S)
△ R116	244 2050 991	Metal Oxide 6.8kohm 1 W	RS14B3A682JNBS(S)
△ R309-312	241 2380 963	Carbon Film 2.2kohm 1/4 W(NB)	RD14B2E222JNBS
△ R319-322	241 2377 976	Carbon Film 130ohm 1/4 W(NB)	RD14B2E131JNBS
△ R323,324	241 2315 967	Fusible 68ohm 1/4 W(FR)	RD14B2E680GFRS
△ R325,326	241 2379 932	Carbon Film 620ohm 1/4 W(NB)	RD14B2E621JNBS
△ R331,332	241 2378 920	Carbon Film 220ohm 1/4 W(NB)	RD14B2E221JNBS
△ R333-336	244 2043 982	Metal Oxide 0.22ohm 1 W	RS14B3AR22JNBS(S)
△ R341,342	241 2375 907	Carbon Film 10ohm 1/4 W(NB)	RD14B2E10JNBS
△ R345-348	244 2043 982	Metal Oxide 0.22ohm 1 W	RS14B3AR22JNBS(S)
△ R351	241 2379 958	Carbon Film 750ohm 1/4 W(NB)	RD14B2E751JNBS
△ R501,502	244 2043 937	Metal Oxide 10ohm 1 W	RS14B3A10JNBS(S)

Ref. No.	Parts No.	Parts Name	Remarks
△ R505-508	244 2050 933	Metal Oxide 180ohm 1 W	RS14B3A181JNBS(S)
△ R601-604	241 2380 950	Carbon Film 2kohm 1/4 W(NB)	RD14B2E202JNBS
△ R627,628	244 2052 902	Metal Oxide 2.7kohm 1 W	RS14B3A272JNBS(S)
△ R631-635	244 2051 990	Metal Oxide 4.7kohm 1 W	RS14B3A472JNBS(S)
△ R711,712	244 2043 908	Metal Oxide 680ohm 1 W	RS14B3A681JNBS(S)
△ R713	241 2387 940	Carbon Film 4.7ohm 1/4 W(NB)	RD14B2E47JNBS
△ R716	241 2387 940	Carbon Film 4.7ohm 1/4 W(NB)	RD14B2E47JNBS
△ R717,718	244 2043 908	Metal Oxide 680ohm 1 W	RS14B3A681JNBS(S)
VR202	211 0798 103	Variable Resistor 100kohm	Balance
VR203	211 0834 012	Variable Resistor 10kohm	Treble
VR204	211 0834 009	Variable Resistor 30kohm	Bass
CAPACITORS GROUP			
C101-110	253 4237 982	Ceramic Cap. 56pF/50V	CC45SL1H560J
C111,112	253 4444 907	Ceramic Cap. 220pF/50V	CC45SL1H221J
C113	255 1265 978	Mylar Film 0.022μF/50V	CQ93M1H223J(B)
C207,208	254 4260 948	Electrolytic 1μF/50V	CE04W1H010M
C209-212	253 4538 949	Ceramic Cap. 100pF/50V	CC45SL1H101J
C213,214	254 4260 948	Electrolytic 1μF/50V	CE04W1H010M
C215,216	254 4254 909	Electrolytic 10μF/16V	CE04W1C100M
C217,218	255 1265 994	Mylar Film 0.033μF/50V	CQ93M1H333J(B)
C219,220	254 4260 919	Electrolytic 0.22μF/50V	CE04W1HR22M
C221,222	254 4260 906	Electrolytic 0.1μF/50V	CE04W1H0R1M
C223,224	254 4260 935	Electrolytic 0.47μF/50V	CE04W1HR47M
C225,226	254 4260 922	Electrolytic 0.33μF/50V	CE04W1HR33M
C227,228	256 1034 953	Metalized 0.068μF/50V	CF93A1H683J
C229,230	255 1265 994	Mylar Film 0.033μF/50V	CQ93M1H333J(B)
C261	253 1181 917	Ceramic Cap. 0.022μF/50V	CK45F1H223Z
C301,302	254 4254 909	Electrolytic 10μF/16V	CE04W1C100M
C303,304	253 4538 949	Ceramic Cap. 100pF/50V	CC45SL1H101J
C305,306	253 4454 900	Ceramic Cap. 560pF/50V	CC45SL1H561J
C307,308	253 1117 907	Ceramic Cap. 2700pF/50V	CK45B1H272K
C309,310	254 4252 969	Electrolytic 470μF/10V	CE04W1A471M
C311,312	253 4537 966	Ceramic Cap. 47pF/50V	CC45SL1H470J
C317,318	253 4470 900	Ceramic Cap. 10pF/500V	CC45SL2H100D
C319,320	254 4260 948	Electrolytic 1μF/50V	CE04W1H010M
C321,322	254 4260 993	Electrolytic 22μF/50V	CE04W1H220M
C329-332	254 4262 904	Electrolytic 4.7μF/63V	CE04W1J4R7M
C333,334	253 4456 908	Ceramic Cap. 680pF/50V	CC45SL1H681J
C339	254 4262 755	Electrolytic 100μF/63V	CE04W1J101MC
C341	253 4538 949	Ceramic Cap. 100pF/50V	CC45SL1H101J
C343,344	253 4444 907	Ceramic Cap. 220pF/50V	CC45SL1H221J
C361,362	253 4490 906	Ceramic Cap. 68pF/500V	CC45SL2H680J
C363,364	253 4470 900	Ceramic Cap. 10pF/500V	CC45SL2H100D
C371	253 4537 966	Ceramic Cap. 47pF/50V	CC45SL1H470J
C401,402	254 4261 918	Electrolytic 47μF/50V	CE04W1H470M
C403	254 3056 959	Electrolytic 10μF/50V (Bipolar)	CE04W1H100MBP
C404	254 3080 909	Electrolytic 10μF/35V (Bipolar)	CE04W1V100MBP
C405,406	254 4260 993	Electrolytic 22μF/50V	CE04W1H220M
C407,408	253 1180 921	Ceramic Cap. 1000pF/50V	CK45B1H102K
C409,410	254 4260 948	Electrolytic 1μF/50V	CE04W1H010M
C411,412	255 1265 936	Mylar Film 0.01μF/50V	CQ93M1H103J(B)
C413-416	253 9039 906	BC Ceramic Cap. 0.1μF/25V	CK45-1E104Z
C451,452	253 1179 987	Ceramic Cap. 470pF/50V	CK45B1H471K
C501,502	256 1034 979	Metalized 0.1μF/50V	CF93A1H104J
C503-506	255 1264 982	Mylar Film 0.0047μF/50V	CQ93M1H472J(B)
C509,510	255 1265 936	Mylar Film 0.01μF/50V	CQ93M1H103J(B)
C601,602	255 1265 936	Mylar Film 0.01μF/50V	CQ93M1H103J(B)
C603	254 4250 945	Electrolytic 330μF/6.3V	CE04W0J331M

1U-2729A,B CONTROL UNIT ASS'Y (for Europe Version)

Ref. No.	Parts No.	Parts Name	Remarks
C604	254 4252 930	Electrolytic 100µF/10V	CE04W1A101M
C605	254 4252 901	Electrolytic 220µF/10V	CE04W1A220M
C606	255 1265 978	Mylar Film 0.022µF/50V	CQ93M1H223J(B)
C701,702	254 4260 948	Electrolytic 1µF/50V	CE04W1H010M
C703,704	254 4256 952	Electrolytic 220µF/25V	CE04W1E221M
C707	256 1042 903	Metalized 0.1µF/250V	CF93A2E104K
C708,709	254 4263 916	Electrolytic 0.22µF/100V	CE04W2AR22M
C710	255 1265 978	Mylar Film 0.022µF/50V	CQ93M1H223J(B)
C711	253 1181 904	Ceramic Cap. 0.01µF/50V	CK45F1H103Z
C712,713	254 4260 980	Electrolytic 10µF/50V	CE04W1H100M
C714	253 1181 904	Ceramic Cap. 0.01µF/50V	CK45F1H103Z

OTHER GROUP			Q'ty
	—	(P.W.Board)	(1)
L301,302	235 0068 004	Inductor 1µH	2
SW101	212 0336 005	Rotary Switch	1
SW201	212 1097 000	1 P Push Switch	1
SW202	212 1127 006	1 P Push Switch	1
SW501	212 1132 004	2 P Push Switch	1
RL101-106	214 0127 003	Relay(RY-12W)	6
RL601	214 9003 005	Relay	1
	205 0484 001	8 P SP Terminal	1
	204 8354 004	Headphone Jack	1
	204 8355 003	Headphone Jack	1
	204 8266 008	4 P Pin Jack(S-GND)	2
	204 8278 009	6 P Pin Jack(S-GND)	1
T.P.	205 0190 036	3 P NH Conn. Base	2
CN901B	205 0666 052	5 P Conn. Base(9130)	1
CN201B	205 0666 007	10 P Conn. Base(9130)	1
CN801B	205 0375 042	14 P Conn. Base(KR-PH)	1
CN701A	205 0233 032	3 P EH Conn. Base	1
CN701	203 4833 018	3 P EH-SCN Conn. Cord	1
CN2B	203 5019 103	3 P-PH 2 P-SAN Ass'y	1
CN502	204 0452 001	6 P SCN-SCN Conn. Cord	1
CN501	204 2692 102	7 P SCN-SCN Conn. Cord	1
	203 0600 009	1 P Contact Ass'y	1

1U-2728D for U.S.A., Canada PARTS LIST

(Same as 1U-2728A, B for Europe Black and Gold except the following Parts)

Ref. No.	Part No.	Part Name	Remarks	Q'ty
CAPACITORS GROUP				
C261	253 1181 917	Ceramic Cap. 0.022µF/50 V	Delete	-
OTHER GROUP				
	205 0632 002	8P SP Terminal	Change	1

1U-2728G for Multi Voltage Model PARTS LIST

(Same as 1U-2728A, B for Europe Black and Gold except the following Parts)

Ref. No.	Part No.	Part Name	Remarks	Q'ty
OTHER GROUP				
	205 0472 013	8P SP Terminal	Change	1
	204 8341 004	Headphone Jack	Change	1

Ref. No.	Parts No.	Parts Name	Remarks
----------	-----------	------------	---------

SEMICONDUCTORS GROUP

IC801	262 1579 303	IC HD404304A13P	µ-com
IC802	263 0476 002	IC LB1639	
IC803	263 0535 008	IC M51594AL	
IC901	265 0322 004	IC BA4558	
TR801-806	273 0235 923	Transistor 2SC1841(E/F)	
TR807	271 0192 905	Transistor 2SA933S(S)	
TR808,809	273 0303 910	Transistor 2SC1740S(S)	
TR810	269 0026 900	Transistor RN2202	Built in Resistor
TR901-904	275 0038 045	FET 2SK369(BL)/(GR)-C	
D001	276 0616 907	Diode 1SS252	
D801-808	276 0616 907	Diode 1SS252	
D901,902	276 0616 907	Diode 1SS252	
LD801	393 9453 916	LED SEL1810A	
LD802-807	393 9434 906	LED SEL1210A	
	499 0150 008	Remocon Sensor SBX1610-52	

RESISTORS GROUP (Not included Carbon Film ±5%, 1/4 W Type.)

Refer to the Schematic Diagram for those parts.)

△ R832	241 2387 940	Carbon Film 4.7ohm 1/4 W(NB)	RD14B2E4R7JNBS
△ R936,937	241 2377 905	Carbon Film 68ohm 1/4 W(NB)	RD14B2E68JNBS
VR201	211 0761 004	Variable Resistor 30kohm	VR201 Main Volume

CAPACITORS GROUP

△ C001,002	253 8003 713	Ceramic Cap. 4700pF/400 V	CK45E2GAC472MC
C202	253 1181 917	Ceramic Cap. 0.022µF/50 V	CK45F1H223Z
C203,204	254 4254 909	Electrolytic 10µF/16 V	CE04W1C100M
C205	253 1181 917	Ceramic Cap. 0.022µF/50 V	CK45F1H223Z
C262	253 4537 966	Ceramic Cap. 47pF/50 V	CC45SL1H470J
C715	253 1181 904	Ceramic Cap 0.01µF/50 V	CE45F1H103Z
C801	254 4213 937	Electrolytic 100µF/6.3 V	CE04W0J101 M(SRA)
C802	253 1181 917	Ceramic Cap. 0.022µF/50 V	CK45F1H223Z
C803	254 4213 937	Electrolytic 100µF/6.3 V	CE04W0J101 M(SRA)
C804	253 1181 917	Ceramic Cap. 0.022µF/50 V	CK45F1H223Z
C805	254 4213 937	Electrolytic 100µF/6.3 V	CE04W0J101 M(SRA)
C806	254 6190 906	Electrolytic 330µF/6.3 V	CE04W0J331 M(SRA)
C807	259 0007 003	Back up Cap. 8200µF/5.5 V	SB CAP=822=C
C808	253 1181 917	Ceramic Cap. 0.022µF/50 V	CK45F1H223Z
C809	254 4196 973	Electrolytic 4.7µF/50 V	CE04W1H4R 7M(SRA)
C810	254 4196 944	Electrolytic 1µF/50 V	CE04W1H01 0M(SRA)
C811	254 4196 928	Electrolytic 0.33µF/50 V	CE04W1HR3 3M(SRA)
C812	256 1034 982	Metalized 0.12µF/50 V	CF93A1H124 J
C901	254 4260 948	Electrolytic 1µF/50 V	CE04W1H01 0M
C902	253 1181 917	Ceramic Cap. 0.022µF/50 V	CK45F1H223 Z
C903,904	253 4537 966	Ceramic Cap. 47pF/50 V	CC45SL1H47 0J
C905,906	253 1179 929	Ceramic Cap. 150pF/50 V	CK45B1H151 K
C907,908	253 1179 961	Ceramic Cap. 330pF/50 V	CK45B1H331 K
C909,910	253 1179 903	Ceramic Cap. 100pF/50 V	CK45B1H101 K
C911,912	254 4260 948	Electrolytic 1µF/50 V	CE04W1H01 0M
C913,914	255 1251 937	Mylar Film 0.0033µF/50 V	CQ92M1H33 2J(MRZ)
C915,916	254 4252 930	Electrolytic 100µF/10 V	CE04W1A10 1M
C917,918	256 1034 953	Metalized 0.068µF/50 V	CF93A1H68 3J
C919,920	254 4254 909	Electrolytic 10µF/16 V	CE04W1C10 0M
C921,922	255 4223 959	Mylar Film 0.018µF/50 V	CQ92M1H18 3J(MRZ)
C923,924	255 6178 976	Film Cap. 0.0012µF/50 V	CQ09S1H12 2J(SMT)

1U-2729G for Multi-Voltage Model PARTS LIST

(Same as 1U-2729A, B for Europe Black and Gold except the following Parts)

Ref. No.	Parts No.	Parts Name	Remarks	
C925,926	253 1179 961	Ceramic Cap. 330pF/50 V	CK45B1H331K	
C935	254 4252 930	Electrolytic 100µF/10 V	CE04W1A101M	
C936,937	254 4256 936	Electrolytic 47µF/25 V	CE04W1E470M	
OTHER GROUP				Q'ty
	—	(P.W.Board)		(1)
L901,902	235 9003 002	FTZ Choke Coil		2
△ RL001	214 0142 004	Relay(TV-5)		1
△ F001	206 1015 032	Fuse 2.5 A		1
△ F002	206 1015 029	Fuse 1 A T		1
△	203 3950 002	3 P AC Outlet		1
	202 0040 909	Fuse Clip		4
△ SW001	212 1101 005	Power Switch (TV-5)		1
SW801-806	212 5604 910	Tact Switch		6
SW901	212 1099 008	1 P Push Switch	MM/MC	1
	204 8413 000	2 P Pin Jack(C-GND)	Phono	1
XL801	399 9018 003	Ceramic Resonator CST 4.00MGW		1
	205 0692 000	2 P Wrapping Terminal		1
CN201A	205 0667 006	10 P Conn. Base -L(9130)		1
CN901A	205 0337 051	5 P Conn. Base -L(9130)		1
CN2B	205 0406 034	3 P Conn. Base (KR-PH)		1
	203 0494 008	1 P Contact Ass'y		1
	203 0418 000	1 P SIN Cord Ass'y		1
CN801A	204 6497 002	14 P PH-SAN Conn. Cord		1
	203 5018 007	3 P SAN-SAN Conn. Cord		1
	203 5020 008	3 P SIN Cord Ass'y		1
	203 2364 000	2 P SIN Cord Ass'y		1
	203 0600 009	1P Contact Ass'y		1
	415 0299 000	Condenser Cover	for C002	1

Ref. No.	Part No.	Part Name	Remarks	Q'ty
OTHER GROUP				
L901,902	235 9003 002	FTZ Choke Coil	Delete	-
	203 3950 002	3PA Outlet	Delete	-
△ F003	206 1015 032	Fuse 2.5A	Add	1
	202 0040 909	Fuse Clip	Add. (for F003)	2(6)
△ F001	206 1036 011	Fuse (6.3A)	Change	1
△ F002	206 1015 061	Fuse (2A)	Change	1
	513 2323 029	Fuse Label T2.0A	Add for F002	1
	513 2323 045	Fuse Label T6.3A	Add for F001	1
	513 2323 058	Fuse Label T2.5A	Add for F003	1

1U-2729D for U.S.A., Canada PARTS LIST

(Same as 1U-2729A, B for Europe Black and Gold except the following Parts)

Ref. No.	Part No.	Part Name	Remarks	Q'ty
CAPACITORS GROUP				
C262	253 4537 966	Ceramic Cap. 47pF/50 V	Delete	-
OTHER GROUP				
L901,902	235 9003 002	FTZ Choke Coil	Delete	-
△ F001	206 1046 001	Fuse 6.3A	Change	1
△	203 3950 002	3P AC Outlet	Delete	-
△ F002	206 1046 014	Fuse 8A	Change	1
	513 2323 003	Fuse Label 6.3A	Add for F001	1
	513 1897 093	Fuse Label 8A	Add for F002	1

PARTS LIST OF P.W. BOARD: PMA-715R/715RG

1U-2735 A, B MAIN UNIT ASS'Y (for Europe Version)

Ref. No.	Parts No.	Parts Name	Remarks	Ref. No.	Parts No.	Parts Name	Remarks
SEMICONDUCTORS GROUP				CAPACITORS GROUP			
IC201	265 0322 004	IC BA4558	μ-com IC Protector 15 V Regulator +6 V	△ R631	244 2051 990	Metal Oxide 4.7kohm 1 W	RS14B3A472JNBS(S)
IC401,402	263 0930 001	ICμPC5023CS-064		△ R632-635	244 2064 932	Metal Oxide 3.9kohm 1 W	RS14B3A392JNBS(S)
IC403,404	262 0874 009	IC TLP521-1(BL)		△ R711,712	244 2043 908	Metal Oxide 680ohm 1 W	RS14B3A681JNBS(S)
IC701	268 0073 905	IC ICP-N15		△ R713	241 2387 940	Carbon Film 4.7ohm 1/4 W(NB)	RD14B2E4R7JNBS
IC702	263 0793 002	IC NUM7806FA(S)		△ R716	241 2387 940	Carbon Film 4.7ohm 1/4 W(NB)	RD14B2E4R7JNBS
				△ R717,718	244 2043 908	Metal Oxide 680ohm 1 W	RS14B3A681JNBS(S)
TR301-304	271 0094 919	Transistor 2SA970(BL)		VR202	211 0798 103	Variable Resistor 100kohm	Balance
TR305,306	271 0131 924	Transistor 2SA988(E/F)		VR203	211 0834 012	Variable Resistor 10kohm	Treble
TR307-312	273 0235 923	Transistor 2SC1841(E/F)		VR204	211 0834 009	Variable Resistor 30kohm	Bass
TR313,314	273 0303 910	Transistor 2SC1740S(S)					
TR323	271 0131 924	Transistor 2SA988(E/F)					
TR401,402	271 0280 901	Transistor 2SA1038S(S)					
TR403,404	273 0281 906	Transistor 2SC2705(O)(Y)					
TR405,406	273 0432 904	Transistor 2SC2389S(S)					
TR407,408	271 0168 900	Transistor 2SA1145(O)(Y)					
TR601,602	273 0235 923	Transistor 2SC1841(E/F)					
TR603-605	273 0303 910	Transistor 2SC1740S(S)					
TR606	271 0192 905	Transistor 2SA933S(S)					
TR607	273 0235 923	Transistor 2SC1841(E/F)					
TR608	271 0094 935	Transistor 2SA970(BL/GR)					
TR609	271 0131 924	Transistor 2SA988(E/F)					
TR610-612	273 0235 923	Transistor 2SC1841(E/F)					
TR701	274 0120 002	Transistor 2SD1762(E/F)					
TR702	272 0083 004	Transistor 2SB1185(E/F)					
TR703	271 0280 901	Transistor 2SA1038S(S)					
TR704,705	273 0432 904	Transistor 2SC2389S(S)					
TR706	273 0303 910	Transistor 2SC1740S(S)					
TR707	274 0120 002	Transistor 2SD1762(E/F)					
D101-106	276 0616 907	Diode 1SS252					
D301,302	276 0616 907	Diode 1SS252					
D401-414	276 0616 907	Diode 1SS252					
D601-603	276 0616 907	Diode 1SS252					
D701	276 0553 905	Diode 1SR35-200A					
△ D702	276 0338 007	Diode S4VB20F	Bridge				
D703,704	276 0553 905	Diode 1SR35-200A					
ZD401-404	276 0643 954	Zener Diode MTZJ3.9A	3.9 V				
ZD601	276 0644 911	Zener Diode MTZJ7.5A	7.5 V				
ZD701,702	276 0645 978	Zener Diode MTZJ36A	36 V				
ZD703	276 0644 911	Zener Diode MTZJ7.5A	7.5 V				
ZD704	276 0644 995	Zener Diode MTZJ16	16 V				
ZD705,706	276 0645 907	Zener Diode MTZJ18	18 V				
SC601	279 0016 904	Thyristor SF0R1A42					
RESISTORS GROUP (Not included Carbon Film ±5%, 1/4 W Type. Refer to the Schematic Diagram for those parts.)							
△ R115	244 2052 957	Metal Oxide 5.6kohm 1 W	RS14B3A562JNBS(S)	C101-110	253 4237 982	Ceramic Cap. 56pF/50 V	CC45SL1H560J
△ R116	244 2050 991	Metal Oxide 6.8kohm 1 W	RS14B3A682JNBS(S)	C111,112	253 4444 907	Ceramic Cap. 220pF/50 V	CC45SL1H221J
△ R309-312	241 2380 963	Carbon Film 2.2kohm 1/4 W(NB)	RD14B2E222JNBS	C113	255 1265 978	Mylar Film 0.022μF/50 V	CQ93M1H223J(B)
△ R319-322	241 2377 976	Carbon Film 130ohm 1/4 W(NB)	RD14B2E131JNBS	C207,208	254 4260 948	Electrolytic 1μF/50 V	CE04W1H010M
△ R323,324	241 2315 967	Fusible 68ohm 1/4 W(FR)	RD14B2E680GFRR	C209,210	253 4537 982	Ceramic Cap. 56pF/50 V	CC45SL1H560J
△ R325,326	241 2379 932	Carbon Film 620ohm 1/4 W(NB)	RD14B2E621JNBS	C211,212	253 4538 949	Ceramic Cap. 100pF/50 V	CC45SL1H101J
△ R333-336	244 2043 982	Metal Oxide 0.22ohm 1 W	RS14B3AR22JNBS(S)	C213,214	254 4260 948	Electrolytic 1μF/50 V	CE04W1H010M
△ R341,342	241 2375 907	Carbon Film 10ohm 1/4 W(NB)	RD14B2E100JNBS	C215,216	254 4254 909	Electrolytic 10μF/16 V	CE04W1C100M
△ R345-348	244 2043 982	Metal Oxide 0.22ohm 1 W	RS14B3AR22JNBS(S)	C217,218	255 1265 994	Mylar Film 0.033μF/50 V	CQ93M1H333J(B)
△ R351	241 2379 987	Carbon Film 1kohm 1/4 W(NB)	RD14B2E102JNBS	C219,220	254 4260 919	Electrolytic 0.22μF/50 V	CE04W1HR22M
△ R501,502	244 2043 937	Metal Oxide 10ohm 1 W	RS14B3A100JNBS(S)	C221,222	254 4260 906	Electrolytic 0.1μF/50 V	CE04W1HOR1M
△ R505-508	244 2050 933	Metal Oxide 180ohm 1 W	RS14B3A181JNBS(S)	C223,224	254 4260 935	Electrolytic 0.47μF/50 V	CE04W1HR47M
△ R601-604	241 2380 950	Carbon Film 2kohm 1/4 W(NB)	RD14B2E202JNBS	C225,226	254 4260 922	Electrolytic 0.33μF/50 V	CE04W1HR33M
△ R627	244 2043 940	Metal Oxide 2.2kohm 1 W	RS14B3A222JNBS(S)	C227,228	256 1034 953	Metalized 0.068μF/50 V	CF93A1H683J
△ R628	244 2052 902	Metal Oxide 2.7kohm 1 W	RS14B3A272JNBS(S)	C229,230	255 1265 994	Mylar Film 0.033μF/50 V	CQ93M1H333J(B)
				C261	253 1181 917	Ceramic Cap. 0.022μF/50 V	CK45F1H223Z
				C301,302	254 4254 909	Electrolytic 10μF/16 V	CE04W1C100M
				C303,304	253 4538 949	Ceramic Cap. 100pF/50 V	CC45SL1H101J
				C305,306	253 4454 900	Ceramic Cap. 560pF/50 V	CC45SL1H561J
				C307,308	253 1117 907	Ceramic Cap. 2700pF/50 V	CK45B1H272K
				C309,310	254 4252 969	Electrolytic 470μF/50 V	CE04W1A471M
				C311,312	253 4537 966	Ceramic Cap. 47pF/50 V	CC45SL1H470J
				C317,318	253 4470 900	Ceramic Cap. 10pF/500 V	CC45SL2H100D
				C319,320	254 4260 948	Electrolytic 1μF/50 V	CE04W1H010M
				C321,322	254 4260 993	Electrolytic 22μF/50 V	CE04W1H220M
				C329-332	254 4262 904	Electrolytic 4.7μF/63 V	CE04W1J4R7M
				C333,334	253 4456 908	Ceramic Cap. 680pF/50 V	CC45SL1H681J
				C339	254 4262 755	Electrolytic 100μF/63 V	CE04W1J101MC
				C341	253 4538 949	Ceramic Cap. 100pF/50 V	CC45SL1H101J
				C343,344	253 4444 907	Ceramic Cap. 220pF/50 V	CC45SL1H221J
				C361-364	253 4470 900	Ceramic Cap. 10pF/500 V	CC45SL2H100D
				C371	253 4537 966	Ceramic Cap. 47pF/50 V	CC45SL1H470J
				C401,402	254 4261 918	Electrolytic 47μF/50 V	CE04W1H470M
				C403	254 3056 959	Electrolytic 10μF/50 V (Bipolar)	CE04W1H100MEP
				C404	254 3080 909	Electrolytic 10μF/35 V (Bipolar)	CE04W1V100MEP
				C405,406	254 4260 993	Electrolytic 22μF/50 V	CE04W1H220M
				C407,408	253 1180 921	Ceramic Cap. 1000pF/50 V	CK45B1H102K
				C409,410	254 4260 948	Electrolytic 1μF/50 V	CE04W1H010M
				C411,412	255 1265 936	Mylar Film 0.01μF/50 V	CQ93M1H103J(E)
				C413-416	253 9039 906	BC Ceramic Cap. 0.1μF/25 V	CK45-1E104Z
				C451,452	253 1179 987	Ceramic Cap. 470pF/50 V	CK45B1H471K
				C501,502	256 1034 979	Metalized 0.1μF/50 V	CF93A1H104J
				C503-506	255 1264 982	Mylar Film 0.0047μF/50 V	CQ93M1H472J(E)
				C509,510	255 1265 936	Mylar Film 0.01μF/50 V	CQ93M1H103J(E)
				C601,602	255 1265 936	Mylar Film 0.01μF/50 V	CQ93M1H103J(E)
				C603	254 4250 945	Electrolytic 330μF/6.3 V	CE04W0J331M
				C604	254 4252 930	Electrolytic 100μF/10 V	CE04W1A101M
				C605	254 4252 901	Electrolytic 220μF/10 V	CE04W1A220M
				C606	255 1265 978	Mylar Film 0.022μF/50 V	CQ93M1H223J(E)

1U-2736A, B CONTROL UNIT ASS'Y (for Europe Version)

Ref. No.	Parts No.	Parts Name	Remarks
C701,702	254 4260 948	Electrolytic 1 μ F/50 V	CE04W1H010M
C703,704	254 4256 952	Electrolytic 220 μ F/25 V	CE04W1E221M
C705,706	254 4365 704	Electrolytic 10000 μ F/56 V	CE04W==103MC(DL)
C707	256 1042 903	Metalized 0.1 μ F/250 V	CF93A2E104K
C708,709	254 4263 916	Electrolytic 0.22 μ F/100 V	CE04W2AR22M
C711	253 1181 904	Ceramic Cap. 0.01 μ F/50 V	CK45F1H103Z
C712,713	254 4260 980	Electrolytic 10 μ F/50 V	CE04W1H100M
C714	253 1181 904	Ceramic Cap. 0.01 μ F/50 V	CK45F1H103Z

OTHER GROUP				Q'ty
		(P.W.Board)		(1)
L301,302	235 0068 004	Inductor 1 μ H		2
SW101	212 0336 005	Rotary Switch	Rec out sel	1
SW201	212 1097 000	1 P Push Switch	Loudness	1
SW202	212 1127 006	1 P Push Switch	S.Direct	1
SW501	212 1131 005	2 P Push Switch	SP-A/B	1
RL101-106	214 0127 003	Relay(RY-12W)		6
RL601	214 9003 005	Relay		1
	205 0484 001	8 P SP Terminal		1
	204 8354 004	Headphone Jack	Black model	1
	204 8355 003	Headphone Jack	Gold model	1
	204 8266 008	4 P Pin Jack(S-GND)	Tape	2
	204 8278 009	6 P Pin Jack(S-GND)		1
T.P.	205 0190 036	3 P NH Conn. Base		2
CN901B	205 0666 052	5 P Conn. Base(9130)		1
CN201B	205 0666 007	10 P Conn. Base(9130)		1
CN801B	205 0375 042	14 P Conn. Base(KR-PH)		1
CN701A	205 0233 032	3 P EH Conn. Base		1
CN701	203 4833 018	3 P EH-SCN Conn. Cord		1
CN501	204 2692 102	7 P SCN-SCN Conn. Cord		1
CN502	204 0449 001	6 P SCN-SCN Conn. Cord		1
CN2B	203 5019 103	3 P PH 2 P-SAN Ass'y		1
	203 0600 009	1 P Contact Ass'y		1

1U-2735G for Multi Voltage Model PARTS LIST (Same as 1U-2735A, B for Europe Black and Gold except the following Parts)

Ref. No.	Part No.	Part Name	Remarks	Q'ty
CAPACITORS GROUP				
C261	253 1181 917	Ceramic Cap. 0.022 μ F/50V	Delete	-
OTHER GROUP				
	205 0472 013	8P SP Terminal	Change	1

1U-2735C for Australia, U.K models PARTS LIST (Same as 1U-2735A, B for Europe Black and Gold except the following Parts)

Ref. No.	Part No.	Part Name	Remarks	Q'ty
CAPACITORS GROUP				
C261	253 1181 917	Ceramic Cap. 0.022 μ F/50V	Delete	-
OTHER GROUP				
	205 0472 013	8P SP Terminal	Change	1

Ref. No.	Parts No.	Parts Name	Remarks
SEMICONDUCTORS GROUP			
IC801	262 1579 303	IC HD404304A13P	μ -com
IC802	263 0476 002	IC LB1639	
IC803	263 0535 008	IC M51594AL	
IC901	265 0322 004	IC BA4558	
TR801-806	273 0235 923	Transistor 2SC1841(E/F)	
TR807	271 0192 905	Transistor 2SA933S(S)	
TR808,809	273 0303 910	Transistor 2SC1740S(S)	
TR810	269 0026 900	Transistor RN2202	Built in Resistor
TR901-904	275 0038 045	FET 2SK369(BL)(GR)-C	
D001	276 0616 907	Diode 1SS252	
D801-808	276 0616 907	Diode 1SS252	
D901,902	276 0616 907	Diode 1SS252	
LD801	393 9453 916	LED SEL1810A	
LD802-807	393 9434 906	LED SEL1210A	
	499 0150 008	Remocon Sensor SBX1610-52	

RESISTORS GROUP (Not included Carbon Film $\pm 5\%$, 1/4 W Type. Refer to the Schematic Diagram for those parts.)

Ref. No.	Parts No.	Parts Name	Remarks
Δ R832	241 2387 940	Carbon Film 4.7ohm 1/4 W(NB)	RD14B2E4R7JNBS
Δ R936,937	241 2377 905	Carbon Film 68ohm 1/4 W(NB)	RD14B2E680JNBS
VR201	211 0761 004	Variable Resistor 30kohm	VR201 Main Volume

CAPACITORS GROUP

Ref. No.	Parts No.	Parts Name	Remarks
Δ C001,002	253 8003 713	Ceramic Cap. 4700pF/400 V	CK45E2GAC472MC
C203,204	254 4254 909	Electrolytic 10 μ F/16 V	CE04W1C100M
C205	253 1181 917	Ceramic Cap. 0.022 μ F/50 V	CK45F1H223Z
C262	253 4537 966	Ceramic Cap. 47pF/50 V	CK45SL1H470J
C715	253 1181 904	Ceramic Cap. 0.01 μ F/50 V	CK45F1H103Z
C801	254 4213 937	Electrolytic 100 μ F/6.3 V	CE04W0J101M(SRA)
C802	253 1181 917	Ceramic Cap. 0.022 μ F/50 V	CK45F1H223Z
C803	254 4213 937	Electrolytic 100 μ F/6.3 V	CE04W0J101M(SRA)
C804	253 1181 917	Ceramic Cap. 0.022 μ F/50 V	CK45F1H223Z
C805	254 4213 937	Electrolytic 100 μ F/6.3 V	CE04W0J101M(SRA)
C806	254 6190 906	Electrolytic 330 μ F/6.3 V	CE04W0J331M(SRA)
C807	259 0007 003	Back up Cap. 8200 μ F/5.5 V	SB CAP==822=C
C808	253 1181 917	Ceramic Cap. 0.022 μ F/50 V	CK45F1H223Z
C809	254 4196 973	Electrolytic 4.7 μ F/50 V	CE04W1H4R7M(SRA)
C810	254 4196 944	Electrolytic 1 μ F/50 V	CE04W1H010M(SRA)
C811	254 4196 928	Electrolytic 0.33 μ F/50 V	CE04W1HR33M(SRA)
C812	256 1034 982	Metalized 0.12 μ F/50 V	CF93A1H124J
C901	254 4260 948	Electrolytic 1 μ F/50 V	CE04W1H010M
C902	253 1181 917	Ceramic Cap. 0.022 μ F/50 V	CK45F1H223Z
C903,904	253 4537 966	Ceramic Cap. 47pF/50 V	CC45SL1H470J
C905,906	253 1179 929	Ceramic Cap. 150pF/50 V	CK45B1H151K
C907,908	253 1179 961	Ceramic Cap. 330pF/50 V	CK45B1H331K
C909,910	253 1179 903	Ceramic Cap. 100pF/50 V	CK45B1H0101K
C911,912	254 4260 948	Electrolytic 1 μ F/50 V	CE04W1H010M
C913,914	255 1251 937	Mylar Film 0.0033 μ F/50 V	CQ92M1H332J(MRZ)
C915,916	254 4252 930	Electrolytic 100 μ F/10 V	CE04W1A101M
C917,918	256 1034 953	Metalized 0.068 μ F/50 V	CF93A1H683J
C919,920	254 4254 909	Electrolytic 10 μ F/16 V	CE04W1C100M

1U-2736C for Australia, U.K models PARTS LIST

(Same as 1U-2736A, B for Europe Black and Gold except the following Parts)

Ref. No.	Parts No.	Parts Name	Remarks	Q'ty
C921,922	255 4223 959	Mylar Film 0.018μF/50 V	CQ92M1H183J(MRZ)	
C923,924	255 6178 976	Film Cap. 0.0012μF/50 V	CQ09S1H122J(SMT)	
C925,926	253 1179 961	Ceramic Cap. 330pF/50 V	CK45B1H331K	
C935	254 4252 930	Electrolytic 100μF/10 V	CE04W1A101M	
C936,937	254 4256 936	Electrolytic 47μF/25 V	CE04W1E470M	
OTHER GROUP				
	—	(P.W.Board)		(1)
L901,902	235 9003 002	FTZ Choke Coil		2
△ RL001	214 0142 004	Relay(TV-5)		1
△ F001	206 1015 061	Fuse 2 A		1
△ F002	206 1015 029	Fuse 1 A T		1
△	203 3950 002	3 P AC Outlet		1
	202 0040 909	Fuse Clip		4
△ SW001	212 1101 006	Power Switch (TV-5)		1
SW801-806	212 5604 910	Tact Switch		6
SW901	212 1099 008	1 P Push Switch	MM/MC	1
	204 8413 000	2 P Pin Jack(C-GND)	Phono	1
XL801	399 9018 003	Ceramic Resonator CST 4.00MGW		1
	205 0692 000	2 P Wrapping Terminal		1
CN201A	205 0667 006	10 P Conn. Base -L(9130)		1
CN901A	205 0667 051	5 P Conn. Base -L(9130)		1
	205 0406 034	5 P Conn. Base (KR-PH)		1
	203 0494 008	1 P Contact Ass'y		1
	203 0418 000	1 P SIN Cord Ass'y		1
CN801A	204 6497 002	14 P PH-SAN Conn. Cord		1
	203 5018 007	3 P SAN-SAN Conn. Cord		1
	203 5020 008	3 P SIN Cord Ass'y		1
	203 2364 000	3 P SIN Cord Ass'y		1
	203 0600 009	1 P Contact Ass'y		1
	415 0299 000	Condenser Cover	for C002	1

Ref. No.	Part No.	Part Name	Remarks	Q'ty
CAPACITORS GROUP				
C262	253 4537 966	Ceramic 47pF/50V	Delete	-
OTHER GROUP				
L901,902	235 9003 002	FTZ Choke Coil	Delete	-
△ F002	206 1015 029	Fuse 1AT	Delete	-
△	203 3950 002	3P AC Outlet	Delete	-
	203 0600 009	1P Contact Ass'y	Delete	-

1U-2736G for Multi Voltage Model PARTS LIST

(Same as 1U-2736A, B for Europe Black and Gold except the following Parts)

Ref. No.	Part No.	Part Name	Remarks	Q'ty
CAPACITORS GROUP				
C262	253 4537 966	Ceramic Cap. 0.022μF/50 V	Delete	-
OTHER GROUP				
L901,902	235 9003 002	FTZ Choke Coil	Delete	-
	203 3950 002	3P AC Outlet	Delete	-
△ F003	206 1015 061	Fuse 2A	Add	1
	202 0040 909	Fuse Clip	Add (for F003)	2
△ F001	206 1015 090	Fuse (5A)	Change	1
△ F002	206 1015 001	Fuse (2A)	Change	1
	513 2323 016	Fuse Label T5.0A	Add for F001	1
	513 2323 029	Fuse Label T2.0A	Add for F002	1
	513 2323 032	Fuse Label T2.0A	Add for F003	1
	203 0600 009	1 P Contact Ass'y	Delete	-

WIRING DIAGRAM: PMA-915R/915RG

1 2 3 4 5 6 7 8

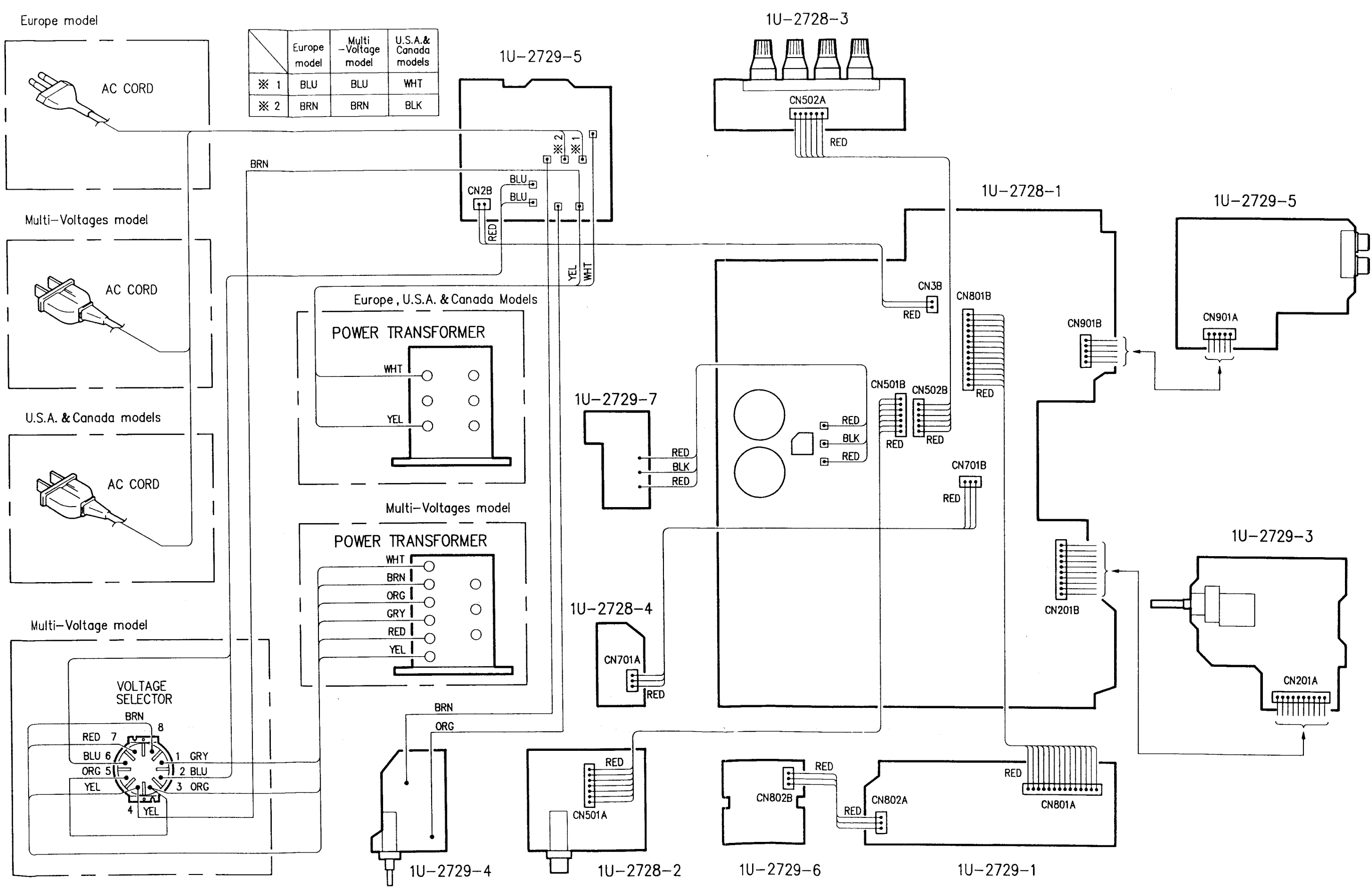

	Europe model	Multi-Voltage model	U.S.A. & Canada models
* 1	BLU	BLU	WHT
* 2	BRN	BRN	BLK

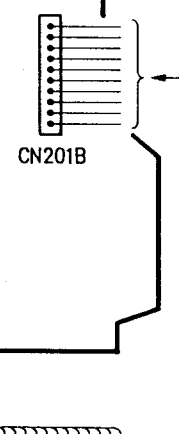
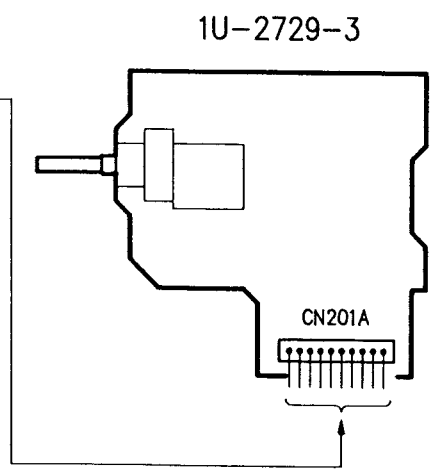
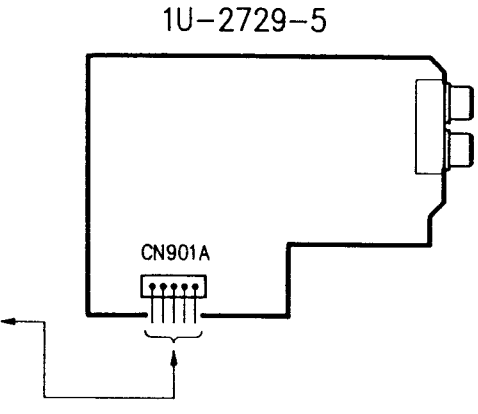
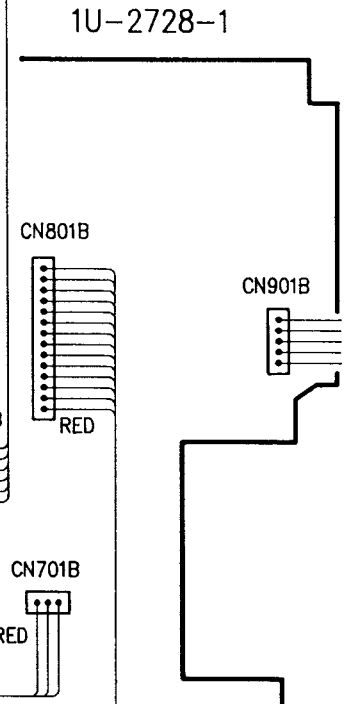
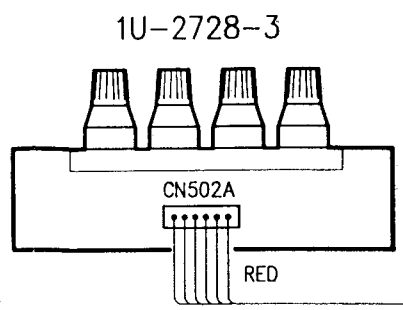
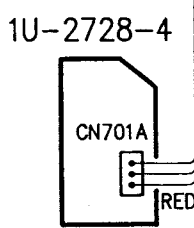
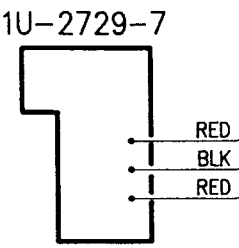
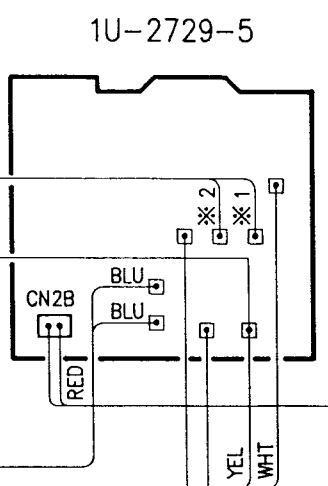
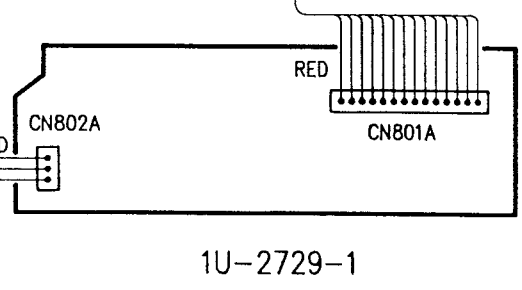
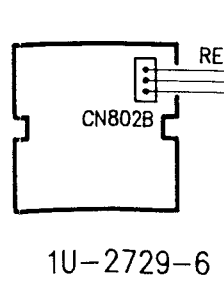
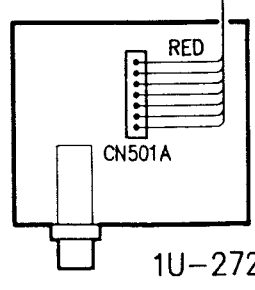
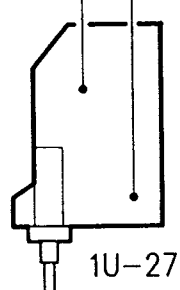
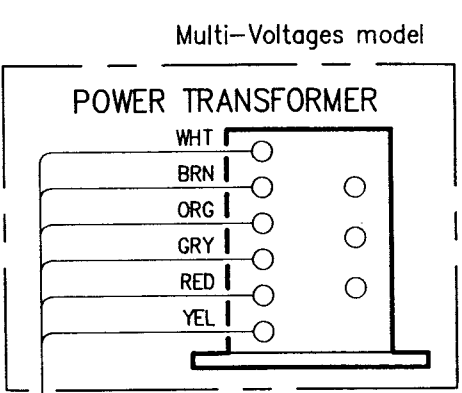
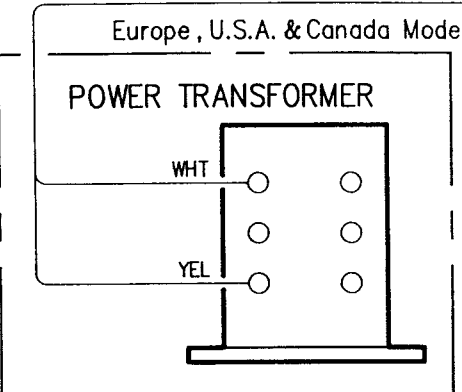
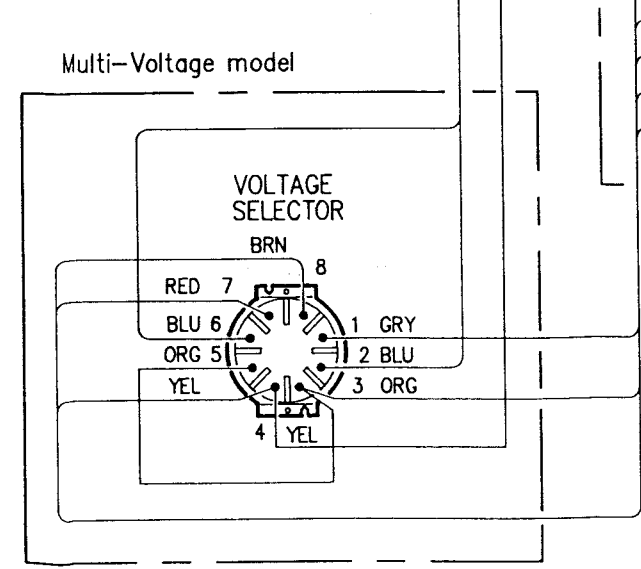
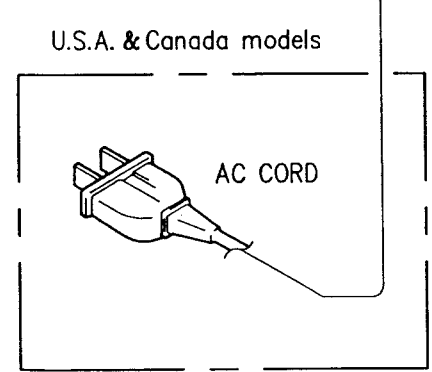
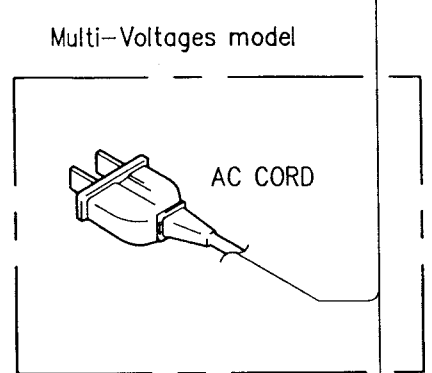
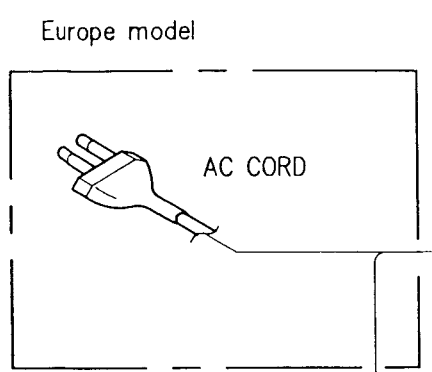

WIRING DIAGRAM: PMA-715R/715RG

1 2 3 4 5 6 7 8

Europe, Australia & U.K. Models

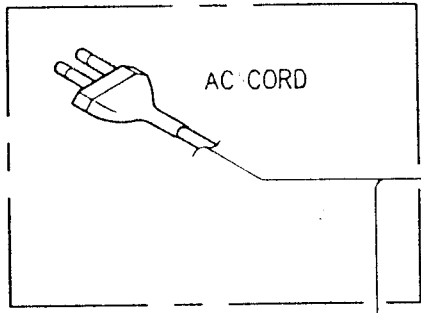

Multi-Voltage model

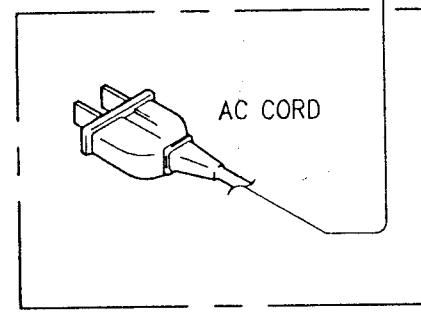

Multi-Voltage model

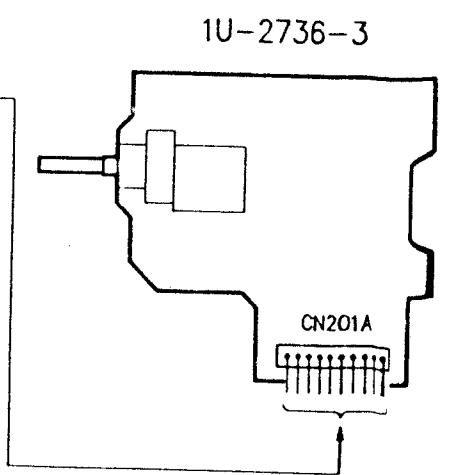
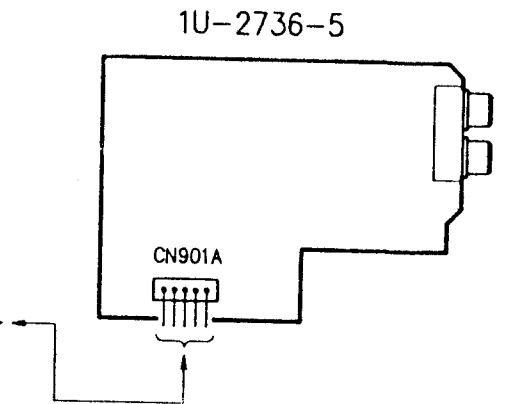
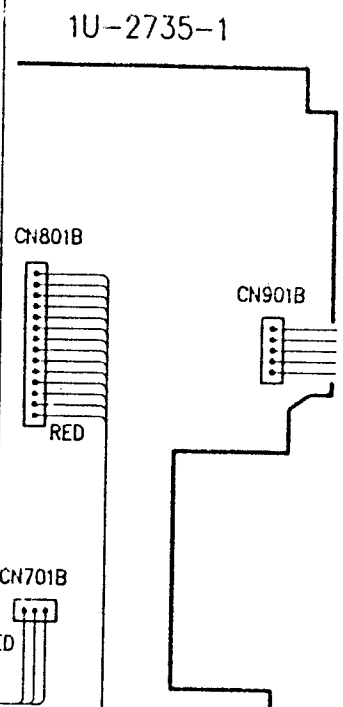
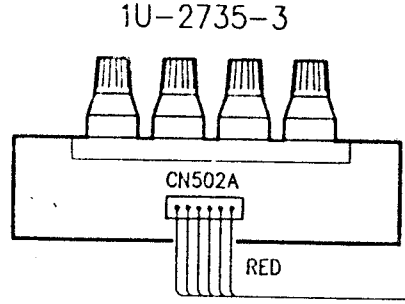
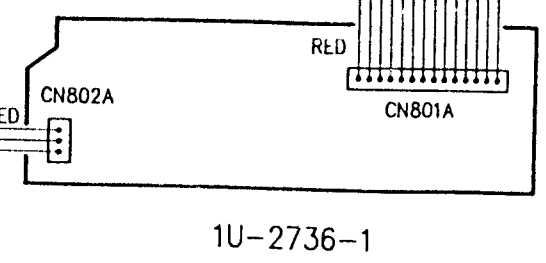
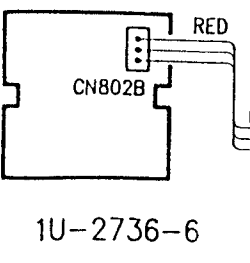
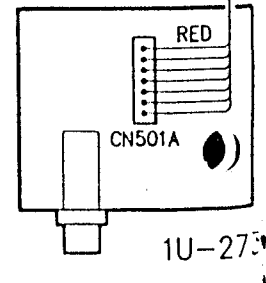
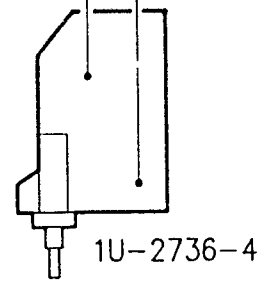
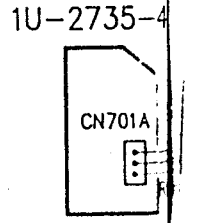
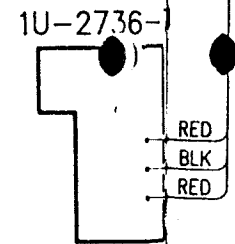
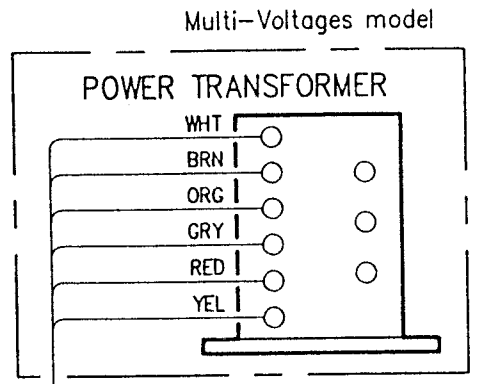
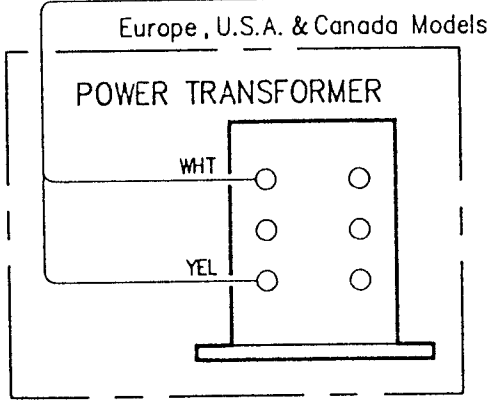
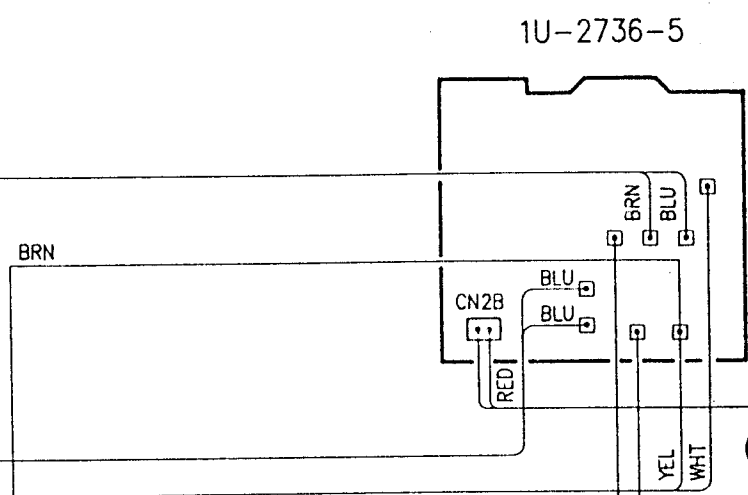
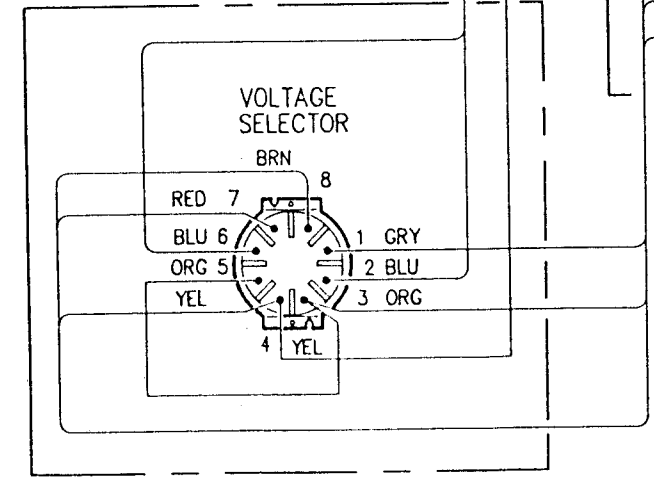

PARTS LIST OF EXPLODED VIEW (PMA-915R/915RG)

Ref. No.	Parts No.	Parts Name	Remarks	Q'ty	Ref. No.	Parts No.	Parts Name	Remarks	Q'ty
1	Note	Main Unit Ass'y		1s	50	204 8278 009	6 P Pin Jack(S-GND)		1
1-1	—	Main Unit		(1)	51	212 1101 006	Power Switch(TV-5)		1
1-2	—	Speaker Switch Unit		(1)	52	204 8413 002	2 P Pin Jack(C-GND)	Phono	1
1-3	—	Speaker Terminal Unit		(1)	53	112 0747 006	VR Knob Joint		1
1-4	—	16 V Unit		(1)	54	112 0643 003	VR Knob Joint(B)		1
2	254 6161 016	Chemicon 12000µF/63 V	C705,706	2	55	Note	Masking Sheet		1
3	212 0336 005	Rotary Switch	SW101 Rec Out	1	56	445 0048 003	Cord Holder (L=76)		1
4	212 1097 000	1 P Push Switch	SW201 Loudness	1	57	122 0212 004	Spacer		1
5	212 1127 006	1 P Push Switch	SW202 S.Direct	1	58	461 0550 030	Rubber Pad	20x20 t25	1
6	212 1132 004	2 P Push Switch	SW501 SP-A/B	1	59	412 3225 108	P.W.B Bracket (A)		2
7	214 0127 003	Relay (RY-12W)	RL101-106	6	60	Note	Card Spacer (L=10)		(n)
8	214 9003 005	Relay	RL601	1	61	124 0032 002	Felt Sheet	t2	1
9	211 0798 103	Variable Resistor100kohm	VR202 Balance	1	62	462 0094 007	Screw Tube		2
10	211 0834 009	Variable Resistor 30kohm	VR204 Bass	1	63	412 3869 001	Radiator Bracket		1
11	211 0834 012	Variable Resistor 10kohm	VR203 Treble	1	64	417 0507 002	Cu Plate		1
12	Note	8 P SP Terminal		1	65	Note	P.W.B. Bracket		1
13	Note	Control Unit Ass'y		1s	66	Note	Fuse nAT	F003	1
13-1	—	µ-com Unit		(1)	67				
13-2	—	Phono EQ. Unit		(1)					
13-3	—	Main Vol. Unit		(1)					
13-4	—	Power Switch Unit		(1)					
13-5	—	AC Unit		(1)					
13-6	—	Remocon Sensor Unit		(1)					
13-7	—	P.T. Unit		(1)					
14	212 1099 008	1 P Push Switch	SW901 MM/MC	1					
15	211 0761 004	Variable Resistor 30kohm	VR201 Main Vol.	1					
16	499 0150 008	Remocon Sensor	SBX1610-52	1					
17	214 0142 004	Relay (TV-5)	RL001	1					
18	Note	Fuse n A T	F002	1					
19	Note	Fuse n A T	F001	1					
20	Note	3 P AC Outlet		1					
21	411 1267 411	Main Chassis		1					
22	104 0194 108	Foot Ass'y		4					
23	461 0774 007	Spacer		2					
24	Note	Rear Panel		1					
25	205 0071 016	Terminal Ass'y		1					
26	Note	AC Cord with Plug		1					
27	415 0305 017	P.V.C. Tube		1					
28	445 0056 008	Cord Bush		1					
29	417 0503 116	Power Radiator		1					
30	273 0389 002	Transistor 2SC3855(O/P/Y)(Z)	TR319,320	2					
31	271 0240 006	Transistor 2SA1491(O/P/Y)(Z)	TR321,322	2					
32	412 3837 101	Side Bracket		2					
33	415 0234 007	Insulating Sheet		4					
34	Note	Inner Panel		1					
35	Note	Function Button		1					
36	412 3835 103	Support Bracket		1					
37	Note	Power Trans		1					
38	Note	Knob (Round)(S)		3					
39	Note	Knob (Fuji)		1					
40	Note	Push Button (Round)		4					
41	Note	Power Button Ass'y		1					
42	Note	Front Panel Ass'y		1					
43	Note	VR Knob Ass'y		1					
44	461 0769 009	Rubber Sheet	100x8xT1	1					
45	445 8004 007	Wire Clamper		10					
46	Note	Top Cover		1					
47	461 0501 089	Rubber Sheet	for T. Cover side	2					
48	Note	Headphone Jack		1					
49	204 8266 008	4 P Pin Jack(S-GND)	Tape	2					

SCREWS

101	473 7002 018	Tapping Screw(S)3x8		18
102	473 7004 003	Tapping Screw(S)4x8		2
103	Note	Tapping Screw(S)3x8	Black	(n)
104	473 8007 009	Cup Screw 3x12		4
105	473 7002 021	Tapping Screw (S)3x8		2
106	Note	Fixing Screw		(n)
107	473 7508 017	Tapping Screw(P)3x10	Black	11
108	473 7508 004	Tapping Screw(P)3x6	Black	2
109	Note	3 P Swelling Screw		(n)
110	473 7004 029	Tapping Screw(S)4x10		4
111	Note	Tapping Screw(S)3x6		2
112	Note	Tapping Screw(S)4x20		4

PACKING & ACCESSORIES (Not included EXPLODED VIEW.)

151	Note	Envelope Sub Ass'y		1s
151-1	505 8006 019	Envelope		(1)
151-2	Note	Inst. Manual		(1)
151-3	499 0277 004	Remote Control	RC-176	(1)
151-4	—	Batteries		(2)
152	504 9102 003	Styrene Paper		1
153	Note	Poly Cover		(n)
154	Note	Cushion		2
155	Note	Carton Case		1
156	Note	Color Label(Gold)		2
157	Note	Side Pad		2
158	Note	DEL Warranty Home		1
159	Note	UPC Label		1
160	Note	CSA Label		1

ADDENDUM LIST

Ref. No.	Parts Name & Description		Part No.				
			Europe Black	Europe Gold	U.S.A. Black	Canada Black	M.-Voltage Gold
1	Main Amp. Unit Ass'y (1s)	(1s)	1U- 2728 A	1U- 2728 B	1U- 2728 D	1U- 2728 D	1U- 2728 G
12	8P SP Terminal (1)	(1)	205 0484 001	205 0484 001	205 0632 002	205 0632 002	205 0472 013
13	Control Unit Ass'y (1s)	(1s)	1U- 2729 A	1U- 2729 A	1U- 2729 D	1U- 2729 D	1U- 2729 G
18	Fuse n A (F002) (1)	(1)	206 1015 029	206 1015 029	206 1046 014	206 1046 014	206 1015 061
			1 A T	1 A T	8 A T	8 A T	2 A T
19	Fuse n A (F001) (1)	(1)	206 1015 032	206 1015 029	206 1046 001	206 1046 001	206 1036 011
			2.5 A T	2.5 A T	6.3 A T	6.3 A T	6.3 A T
20	3 P AC Outlet (1)	(1)	203 3950 002	203 3950 002	203 3926 007	203 3926 007	203 3926 007
24	Rear Panel (1)	(1)	105 1128 105	105 1128 105	105 1128 134	105 1128 134	105 1128 147
26	AC Cord with Plug (1)	(1)	206 2063 009	206 2063 009	206 2060 002	206 2060 002	206 2054 005
34	Inner Panel (1)	(1)	146 1505 101	146 1505 114	146 1505 169	146 1505 169	146 1505 198
35	Function Button (1)	(1)	113 1686 101	113 1686 114	113 1686 127	113 1686 127	113 1686 130
37	Power Trans (1)	(1)	233 6104 005	233 6104 005	233 6128 007	233 6128 007	233 6129 006
38	Knob(Round) (3)	(3)	112 0646 000	112 0646 013	112 0646 000	112 0646 000	112 0646 042
39	Knob(Fuji) (1)	(1)	112 0641 005	112 0641 018	112 0641 005	112 0641 005	112 0641 047
40	Push Button(Round) (4)	(4)	113 1356 004	113 1356 017	113 1356 004	113 1356 004	113 1356 062
41	Power Button (1)	(1)	113 9213 000	113 9213 026	113 9213 000	113 9213 000	113 9213 039
42	Front Panel Ass'y (1)	(1)	144 2385 201	144 2385 214	144 2385 201	144 2385 201	144 2385 227
43	VR Knob Ass'y (1)	(1)	112 0744 009	112 0744 012	112 0744 009	112 0744 009	112 0744 025
46	Top Cover (1)	(1)	102 0521 128	102 0521 131	102 0521 128	102 0521 128	102 0521 144
48	Headphone Jack (1)	(1)	204 8354 004	204 8355 003	204 8354 004	204 8354 004	204 8355 003
55	Masking Sheet (1)	(1)	513 1144 005	513 1144 005	513 9224 008	513 9224 008	—
60	Card Spacer (L=10) (1)	(1)	412 2814 028	412 2814 028	412 2814 028	412 2814 028	412 2814 028
65	P.W.B. Bracket (1)	(1)	—	—	412 3485 003	412 3485 003	412 3485 003
66	Fuse nA (F003) (1)	(1)	—	—	—	—	206 1015 032
							2.5 A T
80	Voltage Sel. Switch (1)	(1)	—	—	—	—	212 0363 007
81	Wood Board (L) (1)	(1)	—	—	—	—	101 2541 006
82	Wood Board (R) (1)	(1)	—	—	—	—	101 2542 005
83	Felt Sheet (4)	(4)	—	—	—	—	124 0032 015
84	Washer φ5 (4)	(4)	—	—	—	—	475 1006 016

SCREWS

103	Tapping Screw (S) 3x8 (n)	473 7015 018 (12)	473 7015 018 (12)	473 7015 018 (13)	473 7015 018 (13)	473 7015 018 (15)
106	Fixing Screw (n)	477 0064 107 (13)	477 0064 107 (13)	477 0064 107 (9)	477 0064 107 (9)	477 0064 107 (9)
109	3 P Swelling Screw (4)	477 0263 005	477 0263 018	477 0263 005	477 0263 005	—
111	Tapping Screw (S) 3x6 (2)	—	—	473 7002 005	473 7002 005	473 7002 005
112	Tapping Screw (S) 4x20 (4)	—	—	—	—	473 7007 039

PACKING & ACCESSORIES (Not included EXPLODED VIEW.)

151	Envelope Sub. Ass'y (1s)	(1s)	GEN 2791	GEN 2791	GEN 2791-01	GEN 2791-01	GEN 2791-02
151-2	Inst. Manual (1)	(1)	511 2633 108	511 2633 108	511 2633 108	511 2633 108	511 2678 008
153	Poly Cover (1)	(1)	505 9102 006	505 9102 006	505 9102 006	505 9102 006	515 9102 006
			(1)	(1)	(1)	(1)	(2)
154	Cushion (2)	(2)	503 1044 205	503 1044 205	503 1044 205	503 1044 205	503 1044 205
155	Carton Case (1)	(1)	501 1796 007	501 1796 007	501 1796 007	501 1796 007	501 1796 010
156	Color Label(Gold) (2)	(2)	—	513 9111 001	—	—	513 9111 001
157	Side Pad (2)	(2)	—	—	—	—	504 0159 071
157	UPC Label (1)	(1)	—	—	517 0105 005	517 0105 002	—
158	DEL Warranty Home (1)	(1)	—	—	515 0690 006	515 0690 006	—
160	CSA Label (1)	(1)	—	—	—	LL-64064	—

NOTE FOR PARTS LIST

- Part indicated with the mark * * are not always in stock and possibly to take a long period of time for supplying, or in some case supplying of part may be refused.
- When ordering of part, clearly indicate "1" and "1" (i) to avoid mis-supplying.
- Ordering part without stating its part number can not be supplied.
- Part indicated with the mark * * is not illustrated in the exploded view.

WARNING:

Parts marked with this symbol have critical characteristics. Use ONLY replacement parts recommended by the manufacturer.

CHEMATIC DIAGRAM: PMA-915R/915RQ

2

3

4

5

6

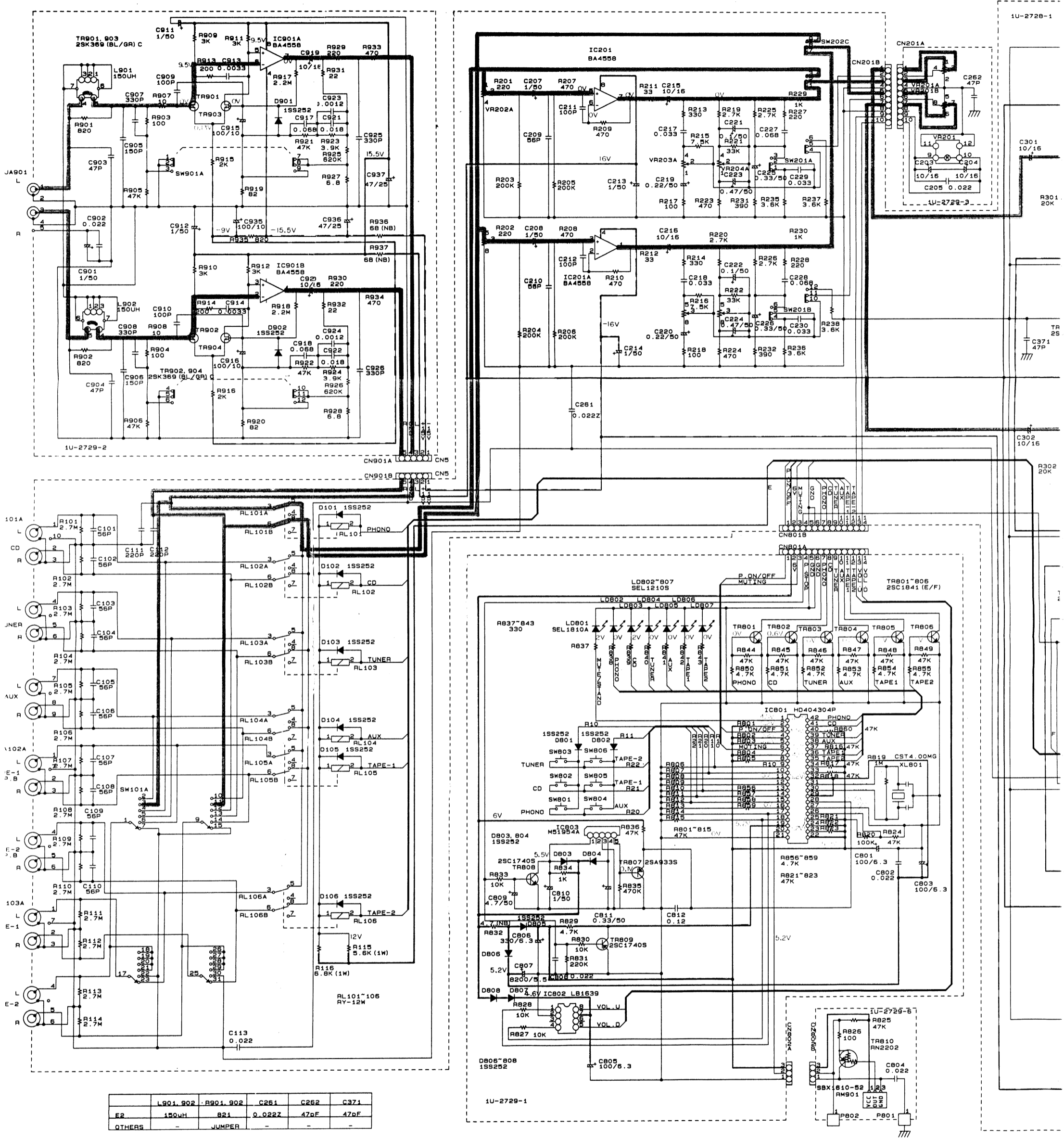

	L901, 902	R901, 902	C251	C252	C371
FR	150uH	821	0.022Z	47pF	47pF
OTHERS	-	JUMPER	-	-	-

