

129

DENON

Hi-Fi Component

SERVICE MANUAL MODEL DRS-810 STEREO CASSETTE TAPE DECK

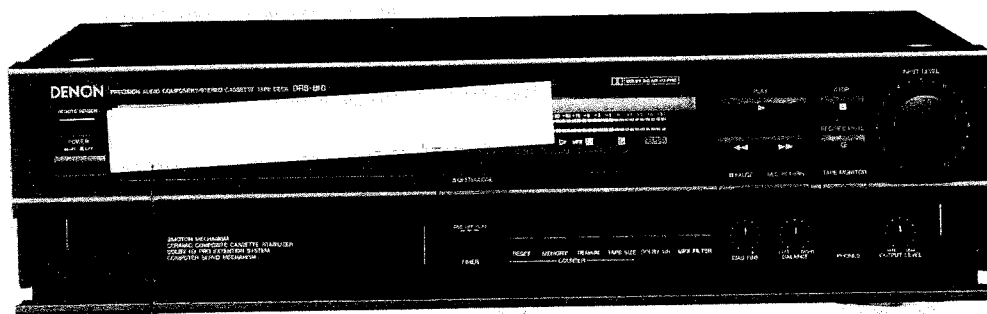

— TABLE OF CONTENTS —

OPERATING INSTRUCTIONS	2~12
SPECIFICATIONS	13
BLOCK DIAGRAM	14
LEVEL DIAGRAM	15
DISASSEMBLY INSTRUCTIONS	16~17
ADJUSTING AND CHECKING THE MECHANISM SECTION	18~19
ADJUSTING THE ELECTRICAL SECTIONS	20~21
PARTS LIST OF EXPLODED VIEW	22
EXPLODED VIEW	23
EXPLODED VIEW OF CASSETTE MECHANISM	24
PARTS LIST OF CASSETTE MECHANISM EXPLODED VIEW	24
PARTS LIST OF PACKING & ACCESSORIES	25
PARTS LIST OF MUSIC SENSOR UNIT	25
PARTS LIST OF 3U-2357 AUDIO METER UNIT	25~27
PARTS LIST OF 3U-2358 POWER SUPPLY UNIT	28
P.W. BOARD OF 3U-2357 AUDIO/METER UNIT	29
P.W. BOARD OF 3U-2358 POWER SUPPLY UNIT	30
SEMICONDUCTORS	30, 31
WIRING DIAGRAM	32
SCHEMATIC DIAGRAM	33
BUNDLE DIAGRAM	34

NIPPON COLUMBIA CO., LTD.

129

IMPORTANT TO SAFETY

WARNING:

TO PREVENT FIRE OR SHOCK HAZARD, DO NOT EXPOSE THIS APPLIANCE TO RAIN OR MOISTURE.

Please, record and retain the Model name and serial number of your set shown on the rating label.
 Model No. DRS-810 Serial No.

IMPORTANT

(BRITISH MODEL ONLY)

The wires in this mains lead are coloured in accordance with the following code:

Blue: Neutral
 Brown: Live

The colours of the wires in the mains lead of this apparatus may not correspond with the coloured markings identifying the terminals in your plug proceed as follows. The wire which is coloured blue must be connected to the terminal which is marked with the letter N or coloured black.

The wire which is coloured brown must be connected to the terminal which is marked with the letter L or coloured red.

FOR YOUR SAFETY





(AUSTRALIAN MODEL ONLY)

To ensure safe operation, the three-pin plug supplied must be connected only with a standard three-pin power point which is effectively earthed through the normal household wiring.

Extension cords used with the equipment must be three-core and be correctly wired to provide connection to earth. Wrongly wired extension cords are a major cause of fatalities.

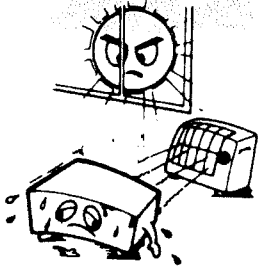
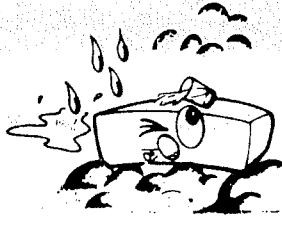
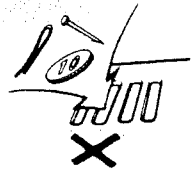
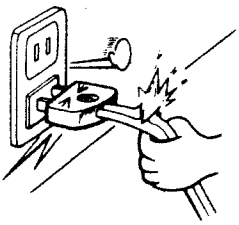
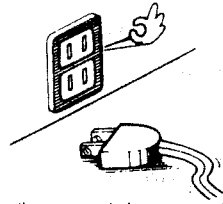
The fact that the equipment operates satisfactorily does not imply that the power point is earthed and that the installation is completely safe. For your safety, if in any doubt about the effective earthing of the power point, contact a qualified electrician.

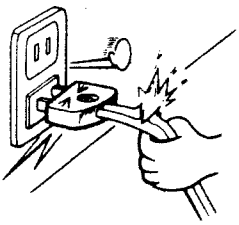
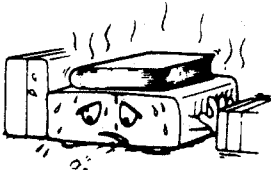
NOTE ON USE/HINWEISE ZUM GEBRAUCH/OBSERVATIONS RELATIVES A L'UTILISATION

 <ul style="list-style-type: none"> • Avoid high temperatures Allow for sufficient heat dispersion when installed on a rack. • Vermeiden Sie hohe Temperaturen Sehen Sie zu, daß eine zureichende Luftzirkulation gewährleistet wird, wenn das Gerät auf ein Regal gestellt wird. • Evitez des températures élevées Tenir compte d'une dispersion de chaleur suffisante lors de l'installation sur une étagère. 	 <ul style="list-style-type: none"> • Keep the set free from moisture, water, and dust. • Halten Sie das Gerät fern von Feuchtigkeit, Wasser und Staub. • Protéger l'appareil contre l'humidité, l'eau et la poussière. 	 <ul style="list-style-type: none"> • Do not let foreign objects in the set. • Keine fremden Gegenstände in das Gerät kommen lassen. • Ne pas laisser des objets étrangers dans l'appareil.
 <ul style="list-style-type: none"> • Handle the power cord carefully Hold the plug when unplugging the cord. • Gehen Sie vorsichtig mit dem Netzkabel um. Halten Sie das Kabel am Stecker, wenn Sie den Stecker herausziehen. • Manipuler le cordon d'alimentation avec précaution. Tenir la prise lors du débranchement du cordon. 	 <ul style="list-style-type: none"> • Unplug the power cord when not using the set for long periods of time. • Wenn das Gerät eine längere Zeit nicht verwendet werden soll, trennen Sie das Netzkabel vom Netzstecker. • Débrancher le cordon d'alimentation lorsque l'appareil n'est pas utilisé pendant de longues périodes. 	 <ul style="list-style-type: none"> • Do not let insecticides, benzene, and thinner come in contact with the set. • Lassen Sie das Gerät nicht mit Insektiziden, Benzin oder Verdünnungsmitteln in Berührung kommen. • Ne pas mettre en contact des insecticides, du benzène et un diluant avec l'appareil.
 <ul style="list-style-type: none"> • Handle the power cord carefully Hold the plug when unplugging the cord. • Gehen Sie vorsichtig mit dem Netzkabel um. Halten Sie das Kabel am Stecker, wenn Sie den Stecker herausziehen. • Manipuler le cordon d'alimentation avec précaution. Tenir la prise lors du débranchement du cordon. 	 <p><i>*(For sets with ventilation holes)</i></p> <ul style="list-style-type: none"> • Do not obstruct the ventilation holes • Die Belüftungsoffnungen dürfen nicht verdeckt werden. • Ne pas obstruer les trous d'aération. 	 <ul style="list-style-type: none"> • Never disassemble or modify the set in any way. • Versuchen Sie niemals das Gerät auseinander zu nehmen oder auf jegliche Art zu verändern. • Ne jamais démonter ou modifier l'appareil d'une manière ou d'une autre.

NAMES AND FUNCTIONS OF PARTS

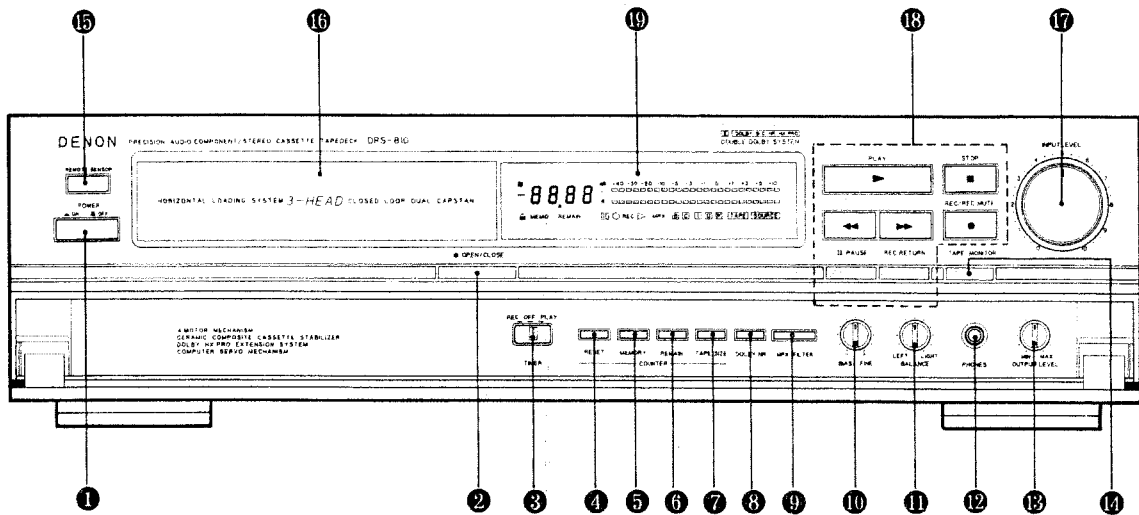

- 1 Power Switch (POWER)**
Press once to turn the power to deck on, and once more to turn the power off.
The deck remains in a stand-by (non-operative) mode for approximately 2 seconds after it is switched on.
- 2 Open/Close Button (▲ OPEN CLOSE)**
Press this button to open and close the cassette tray.
The cassette tray can be closed even if the deck is in the standby mode.
- 3 Timer Switch (TIMER)**
This switch is provided for use with an optional audio timer for unattended recording or morning-alarm playback.
For non-timer operation, this switch should be set in the "OFF" position. See page 11.
- 4 Counter Reset Button (RESET)**
Press this button to reset the tape counter to zero.
- 5 Counter Memory Button (MEMORY)**
During rewinding operations, the tape will stop at the "00.00" counter point automatically when this button is pressed in.
- 6 Remain Button (REMAIN)**
Pressing this button will set Remaining Counter Mode.
- 7 Tape Size Button (TAPE SIZE)**
You can know accurate elapsed time of the tape by adjusting the TAPE SIZE button to the tape size used.
When the TAPE SIZE button is pressed, the current tape size is displayed for 1 sec in the 4-figures counter. If you further press the button during the display, the tape size will change in the following cycle.

C-90 → C-75 → C-60 → C-100
- 8 Dolby NR Button (DOLBY NR)**
To record or play back tapes with Dolby B- or C-type noise reduction, set this switch to "B" or "C". Turn it off when not using the Dolby NR system.
- 9 MPX Filter Button (MPX FILTER)**
The MPX FILTER button should be used to prevent interference with the Dolby NR circuit when making Dolby NR encoded recordings of FM stereo programs.
When making Dolby NR encoded recordings from any program source other than FM stereo, leave this button in the "OFF" position.
- 10 Bias Fine Control (BIAS FINE)**
(For Normal, CrO₂ and Metal tape)
Use this control to fine-adjust the bias. Standard bias is obtained at the center click-stop position. See page 8.
- 11 Balance Control (BALANCE)**
This knob adjusts the recording level balance between the left and right channels. Turn it counter-clockwise to reduce the recording level for the right channel and clockwise to reduce the level for the left channel. Normally the knob should be set to the center click-stop position.
- 12 Head Phones Jack (PHONES)**
For private music enjoyment without disturbing others, or for monitoring a recording, a headphones set may be connected to this jack. Use headphones with an impedance rating of 8 to 1200 ohms.
- 13 Output Level Control (OUTPUT LEVEL)**
This control adjusts playback, recording monitor, and headphones output levels for the both channels simultaneously.
- 14 TAPE MONITOR Button (TAPE MONITOR)**
The SOURCE position of this button allows you to monitor the source program before it is recorded. The TAPE position of this button is used for tape playback monitoring or simultaneous monitoring during recording.
- 15 Remote Sensor (REMOTE SENSOR)**
This is the sensor for the wireless remote control.
- 16 Cassette Tray**
The cassette tray opens forward when the OPEN/CLOSE button is pressed.
Place the cassette tape with the exposed side facing away from you. To close the cassette tray, press the OPEN/CLOSE button again.
- 17 Input Level Control (INPUT LEVEL)**
This knob adjusts the recording input level. It affects the level in both channels. See page 8.

Thank you very much for purchasing the DENON component DRS-810.

The DENON DRS-810 is a top-of-the-line stereo cassette tape deck, capable of outstanding performance in combination with high-grade hi-fi systems.

DENON proudly presents this advanced tape deck to audiophiles and music lovers as a further proof of DENON's non-compromising pursuit of the ultimate in sound quality. The high quality performance and easy operation are certain to provide you with many hours of outstanding listening pleasure.

— TABLE OF CONTENTS —

FEATURES 3
 CONNECTION 3
 NAMES AND FUNCTIONS OF PARTS 4~5
 CASSETTE TAPES 5
 AUTO TAPE SELECT FEATURE 6
 PLAYBACK 6
 RECORDING 7
 MUSIC SEARCH SYSTEM 8
 PROPER RECORDING LEVEL 8
 RECORDING BIAS ADJUSTMENT 8
 REC/REC MUTE AND PAUSE BUTTON 8
 TAPE COUNTER AND MEMORY STOP 9
 TAPE MONITOR BUTTON 10
 DOLBY B & C NOISE REDUCTION SYSTEM 10
 DOLBY HX-PRO HEADROOM EXTENSION SYSTEM 10
 TIMER RECORDING/PLAY BACK 11
 TROUBLESHOOTING 12
 SPECIFICATIONS 13

Please check to make sure the following items are included with the main unit in the carton:

- (1) Operating Instructions 1
- (2) Connection Cords 2

FEATURES

- Computer controlled silent mechanism
- Closed-loop dual-capstan tape transport.
- Non-Slip Reel Drive for Stabilizing Tape Tension
- Dual Power Supply
- Dolby HX-Pro Headroom Extension System
- Dolby B & C Noise Reduction Systems
- Manual Bias Adjustment Control
- Computing Linear Tape Counter with 4-Digit Readout and Memory Stop
- Cassette Stabilizer
- Remaining Tape Counter
- Music Search System
- REC Return System
- FL Peak Level Meters
- Auto Tape Selector
- Optional remote control system

CONNECTION

- Leave your entire system (including this cassette deck) turned off until all connections between the deck and other components have been completed.

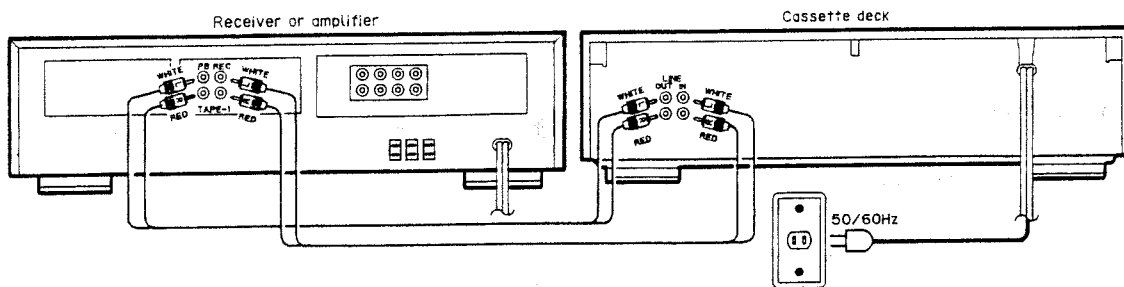

■ Connecting the Deck to an Amplifier

- Before connecting the deck to your amplifier, please review your amplifier's instruction manual.
- Use the white plugs for the left channel and red plugs for the right channel.

■ Tape Dubbing

- Many stereo amplifiers and receivers have tape dubbing circuitry so that tape duplication can be performed between two or more tape decks. Review your amplifier's instruction manual for a full explanation of this mode of operation.

■ Connecting Headphones

To listen through headphones, plug your headphones into the PHONES jack.

■ Installation Precautions

If the deck is placed near an amplifier or tuner, noise (induced hum) or beat interference may result, especially during FM or AM reception. If this occurs, place the deck further away from other components or reorient its position.

AUTO TAPE SELECT FEATURE

This Stereo Cassette Deck contains an Auto Tape Select feature which automatically selects the optimum bias and equalization for the tape in use. This is accomplished by detection of tape type detection holes in the cassette housing.

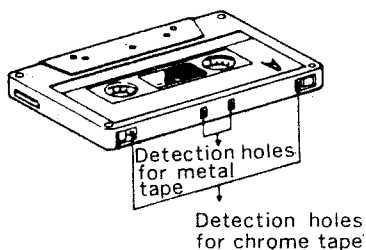

- If a tape without tape type detection holes is used, the deck will automatically adjust itself for normal tapes.

PLAYBACK

- Switch on your amplifier or receiver
- Set the Tape Monitor switch on your amplifier or receiver to the TAPE position.
- The numbers in the illustration below depict the order in which operation steps are carried out.

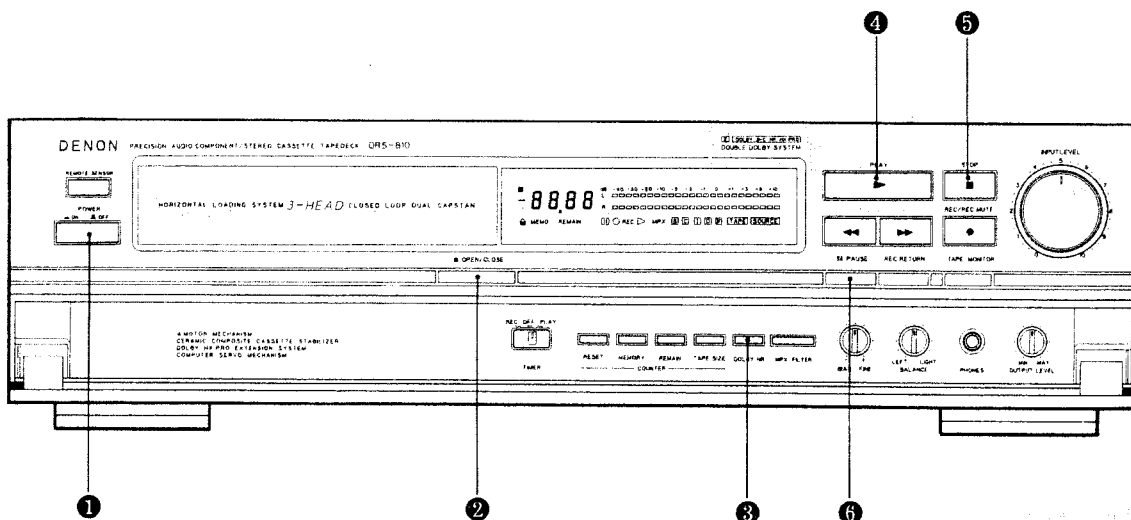

- 1 Press the POWER switch to the ON () position.
- 2 Press the OPEN/CLOSE button and set the cassette in the cassette tray.
- 3 When listening to a tape that has been recorded with Dolby noise reduction, set the DOLBY NR button to match the system used at the time of recording. Pressing the DOLBY NR button selects Dolby noise reduction type B (and the indicator lights up). One more press of the DOLBY NR button selects Dolby noise reduction type C (and the indicator lights up). Pressing the DOLBY NR button once again switches Dolby noise reduction off.
- 4 Press the PLAY button to begin playback. The PLAY () indicator will light during playback.
- 5 Press the STOP () button to stop the playback.
- 6 To pause the playback, press the PAUSE () button. Press the PLAY button to resume playback.

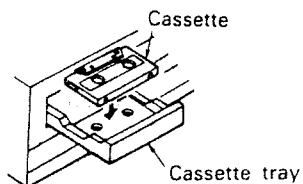

- 3 When listening to a tape that has been recorded with Dolby noise reduction, set the DOLBY NR button to match the system used at the time of recording. Pressing the DOLBY NR button selects Dolby noise reduction type B (and the indicator lights up). One more press of the DOLBY NR button selects Dolby noise reduction type C (and the indicator lights up). Pressing the DOLBY NR button once again switches Dolby noise reduction off.

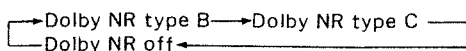

- If different types of Dolby noise reduction are used for record and playback, playback response will be adversely effected.
- If the PLAY, (FF) or (REW) PAUSE, REC/REC MUTE button is pressed while the cassette tray is open, the cassette tray will close and the operation will start.

18 Tape Transport Buttons

	Play Button	Press to playback tape.
	Stop Button	Press to stop the tape in any mode.
	REW Button	Press for fast rewind.
	FF Button	Press for fast forwarding.
	REC/REC MUTE Button	Press the REC/REC MUTE (●) button and PLAY buttons simultaneously to start recording. If only the REC/REC MUTE (●) button is pressed, the deck enters the Recording Pause mode. Pressing this button in the Recording Pause mode will start Auto Rec Mute, and a 5-second silent space is recorded onto the tape. See page 7.
	Pause Button	Press this button to enter the recording pause mode from the recording or recording mute mode. Press this button to enter the playback pause mode from playback mode.
REC RETURN	REC Return Button	When this button is pressed during recording, the tape is rewound to the point at which recording started. Upon reaching this point, the recording standby mode (REC Pause) is engaged. See page 7.

19 Display

Indicators with an encircled number light up when the corresponding button is pressed.

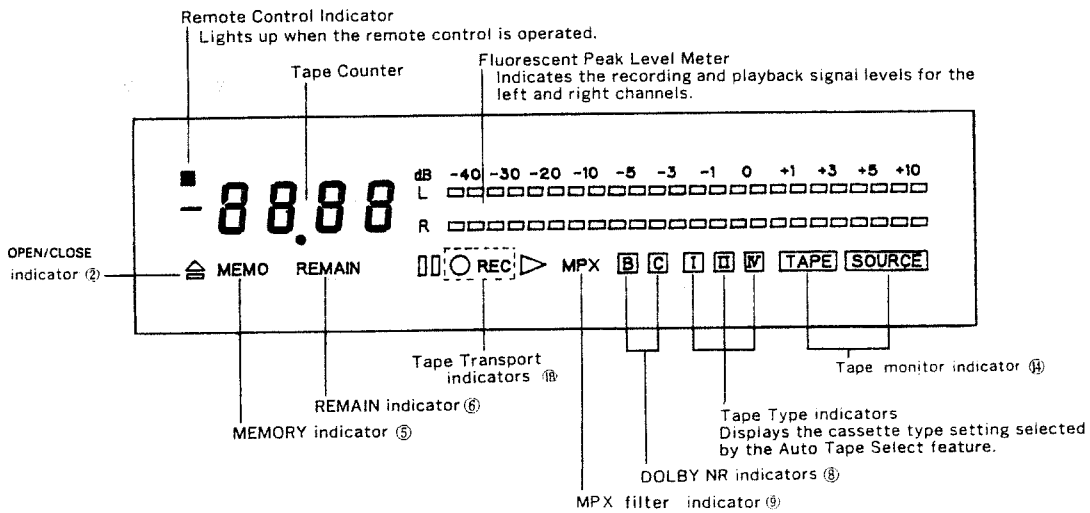

CASSETTE TAPES

■ Handling Precautions

- **C-120 Cassettes**
C-120 cassette tapes are not recommended as they use a very thin tape base which may become tangled around the capstan or pinchroller.
- **Tape slack**
This cassette deck incorporates an automatic tape slackness preventive mechanism, but it can not prevent such a slackness as shown below. Remove it with a pencil or the like prior to use.

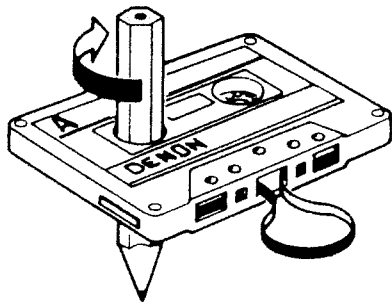

■ Storage Precautions

- Do not store cassette tapes in a place where they will be subject to:
 - Extremely high temperature or excessive moisture
 - Excessive dust
 - Direct sunlight
 - Magnetic fields (near TV sets or speakers)
- To eliminate tape slack, store your cassettes in cassette cases with hub stops

■ Accidental Erasure Prevention

- All cassettes have erasure prevention tabs for each side. To protect valuable recordings from accidental or inadvertent erasure, remove the tab for the appropriate side with a screwdriver or another tool.
- To record on a tape whose erasure prevention tabs have been removed, cover the tab holes with adhesive tape.

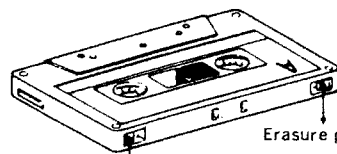

MUSIC SEARCH SYSTEM

This device is a convenient system which detects the non-recorded part of more than 4 seconds between melodies, cues the next melody while the present melody is being reproduced or automatically detects the beginning of the melody now being reproduced and makes it into the reproducible state.

- For cueing the next melody while the present melody is being reproduced:
At PLAY mode, depress the PLAY button and the FF button simultaneously. This device will detect the interval between melodies with the CUE state on, automatically become the PLAY mode and begin performing the next melody.
- For hearing again the melody being reproduced:
At PLAY mode, depress the PLAY button and the REW button simultaneously. This device will detect the interval between melodies with the REVIEW state on, automatically become the PLAY mode, detect the beginning of the melody now being performed and play it from the first again.

Note about MUSIC SEARCH action :

MUSIC SEARCH is a function which operates by detecting a comparatively long non-recorded part on the tape. Therefore, MUSIC SEARCH may not operate normally in the following cases.

- Sound on the tape is interrupted by speech or conversation.
- Long periods of pianissimo (softly played music) or non-recorded intervals occur on the tape.
- The tape has picked up noise in a non-recorded interval.
- Non-recorded intervals on the tape are less than 4 seconds in length.
- Noise-emitting electrical appliances are in operation nearby. i.e.; Electric razors, drills, refrigerators, etc.

PROPER RECORDING LEVEL

A too high recording level can saturate the tape and cause distortion. On the other hand, if the recording level is set too low, soft passages will be marked by residual noise. A proper recording level is the single most important factor for making well balanced recordings.

Guideline for maximum recording level

TYPE I (Normal)	+1 dB level on peaks
TYPE II (CrO ₂)	+3 dB level on peaks
TYPE IV (Metal)	+5 dB level on peaks

Note : The optimum recording level differs depending on the program source and the type of tape used.

Meter reading differences between Left and Right channels

The left and right channel readings of the Peak Level Meter can differ due to variations in the input signal levels. In such cases, use the BALANCE control to adjust the channel input balance until identical meter readings are obtained for both channels.

RECORDING BIAS ADJUSTMENT

For best recording results, monitoring during recording and comparing different recordings using your own judgement are essential.

The DRS-810 is equipped with a BIAS FINE control to assist you in setting the proper bias for different types and brands of tape. At the center stop-click position, the deck is set to the reference bias level for Normal, CrO₂ and Metal tape. If the resulting recording in this position has too much or too little high frequency content, adjusting the BIAS FINE control can be useful to achieve better results.

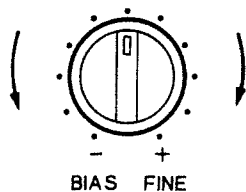

If the high frequencies (treble sounds) are to be boosted, turn the BIAS FINE control counter-clockwise to decrease the bias current. Turn the control clockwise to increase bias current.

By the use of this control, you can record tapes with a frequency response that will perfectly match your listening taste.

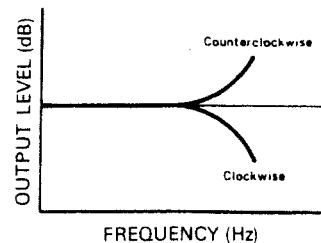

REC/REC MUTE AND PAUSE BUTTON

- To record a 5-second blank section during recording:
Press the REC/REC MUTE (●) button. A 5-second blank will be recorded and the deck will enter the recording standby mode.
- To record a 5-second blank section during the recording standby mode:
Press the REC/REC MUTE (●) button from the recording standby mode. A 5 second blank will be recorded and the deck will enter the recording standby mode again.

- To cancel recording of blank space:
Press the PAUSE (||) button. Blank space recording will be cancelled and the deck enters the recording standby mode.
- To extend the blank section with another 5 seconds or more:
Simply press the REC/REC MUTE (●) button and the blank section will be increased with another 5 seconds.

RECORDING

- Switch on your amplifier or receiver and the source component.
- Set the Tape Monitor switch on your amplifier or receiver to the SOURCE position.

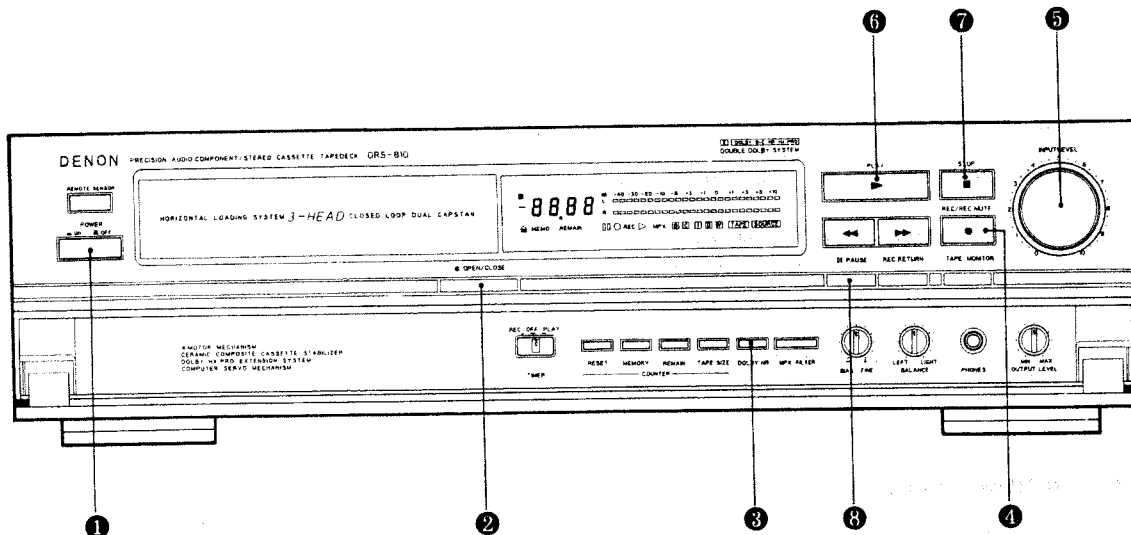

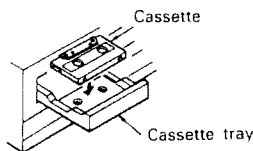

- 1 Press the POWER switch to the ON () position.
- 2 Press the OPEN/CLOSE button and set the cassette in the cassette tray.

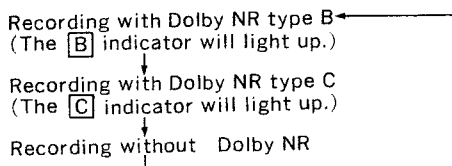

(Check that the accidental erasure prevention tabs are intact.)

- 3 Press the DOLBY NR button and select the Dolby NR type that suits the recording.



- 4 Press the REC/REC MUTE (●) button to set the recording pause mode. The  indicator will light up.
- 5 Adjust the recording level with the INPUT LEVEL control while watching the Peak Level Meter, then adjust the balance of the left and right channels with the BALANCE control.
- 6 Press the PLAY button to start the recording. The PLAY (▶) and the  indicator will light during recording.
- 7 To stop recording, press the STOP (■) button.
- 8 To pause the recording, press the PAUSE (||) button. Press the PLAY button to resume recording.

Caution :

- Be careful not to erase important recordings by mistake. Inadvertent start of recording will happen in the following cases:

1. If the PLAY button is pressed while the  indicator lights, recording starts.
2. If the PLAY (▶) and REC/REC MUTE (●) button are pressed at the same time, recording starts. The best way to avoid accidental erasure is to break off the two erasure prevention tabs on the cassette housing.

REC RETURN Button

Use of the recording return function is convenient when re-recording or when cancelling a recording. When pressed during recording, the tape is rewound to the position where recording started, and the deck will enter the recording standby mode.

Cautions :

The return position arrived at with the recording return function will be where rewinding has continued about 2 seconds beyond the recording start position. Caution is in order here since it is possible that the end of the previous selection might be erased on tapes that have been recorded without at least 5 seconds of blank spaces between the songs.

TAPE MONITOR BUTTON

This Stereo cassette deck uses a three-head system which permits simultaneous "off-the-tape monitoring" during recording. Incidentally, as this Stereo Cassette Deck adopts an automonitor system, **TAPE** or **SOURCE** can automatically be activated according to the operation conditions. These modes can also be activated manually.

Recording	<p>Monitor button → TAPE</p>	The signal recorded on the tape is monitored simultaneously "off-the-tape". This monitoring mode enables you easy check for optimum recording levels. In the TAPE mode, the FL PEAK METER indicates the signal levels played back off-the-tape.
	<p>Monitor button → SOURCE</p>	The SOURCE position enables you to monitor the input source signal before it is recorded on the tape. Using the FL PEAK METER, this mode is convenient for setting recording levels or input level monitoring during recording.
Playback	<p>Monitor button → TAPE</p>	During playback, the MONITOR button must be placed in the TAPE position. If it is set in the SOURCE position, the signal from the tape won't be heard.

DOLBY B & C NOISE REDUCTION SYSTEM

- The Dolby noise reduction system substantially reduces the tape background noise (hiss) inherent in the cassette medium. Dolby B NR is most widely in use. However, Dolby C NR is a much more recent development and represents a significantly improvements over Dolby B NR.
- Tape background noise consists primarily of high frequency information which is particularly annoying during soft passages. The Dolby NR system increase the level of low volume mid and high frequency signal during recording and reduces the level of these signals by an identical amount during playback. As a result, the playback signal is identical to the original source signal, but the level of background noise generated by the tape is greatly reduced.

- The operating principle of Dolby C NR is similar to that of Dolby B NR except for the encoding/decoding response curves. The noise reduction effect obtained with Dolby C NR is up to 20dB, compared to 10dB with Dolby B NR. In addition, Dolby C NR uses an anti-saturation network and spectral skewing circuitry, for a significant improvement in the dynamic range of the mid- to high-frequencies.

DOLBY HX-PRO HEADROOM EXTENSION SYSTEM

This deck is equipped with the DOLBY HX-PRO headroom extension system. Since the system functions automatically during recording, no switching operation or adjustment is required. The system is effective with any type of Normal, CrO₂ or Metal tapes.

The Dolby HX-PRO headroom extension system functions during recording to lift up the saturation level in the treble range. Therefore, most of the treble range components distorted or lost during recording on conventional cassette decks are more faithfully recorded on the new DRS-810 cassette deck.

Features of the DOLBY HX-PRO headroom extension system

- (1) Performance of Normal and CrO₂ tapes can be up-graded closer to that of Metal tapes.
- (2) The dynamic range in the treble is improved significantly.
- (3) Since no decoding in playback is necessary, the improvement can be obviously heard on any hi-fi playback system including portable components and car systems.
- (4) The system functions whether the Dolby B/C NR is engaged or not.

TAPE COUNTER AND MEMORY STOP

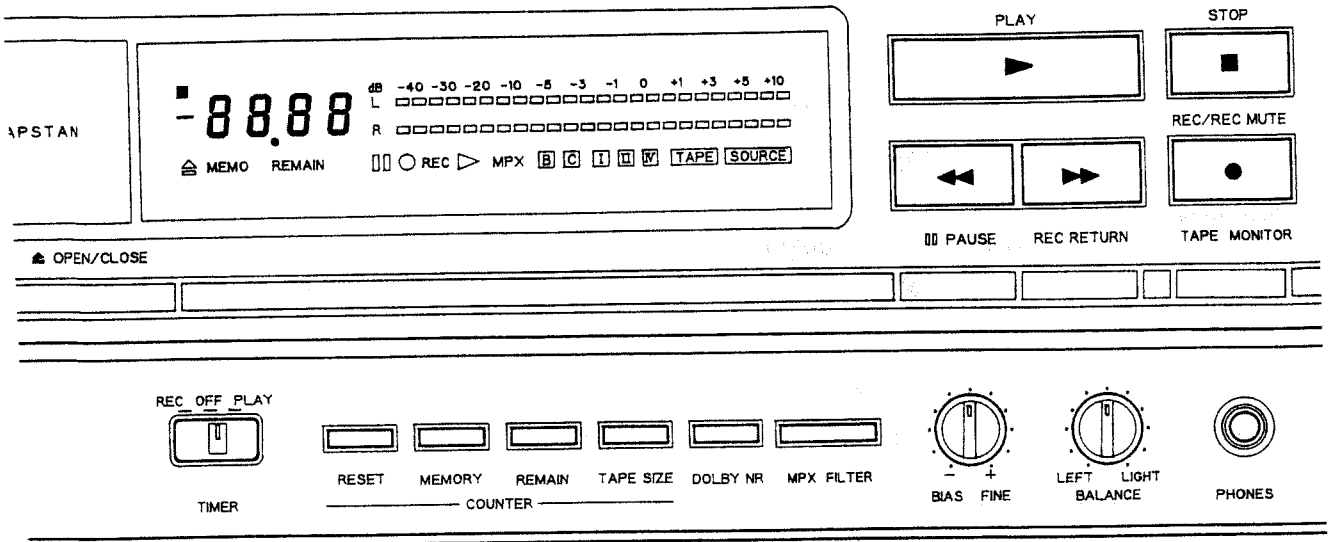

1) Tape Counter Indicators

(1) Linear Tape Counter

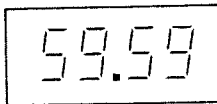

- The tape transport during all modes is indicated in minutes and seconds.
- Press the RESET button to reset the Tape Counter to "00.00".

Note: During recording or playback, the counter indication is useful for noting the location of existing selections or the position from where recording is to start.

(2) Remaining Tape Counter

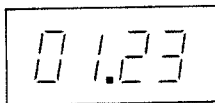

- The remaining time until the end of the tape is displayed.
- The seconds are not displayed when the remaining time is still more than 8 minutes.

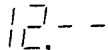

- When playback or recording is started, "-- --" will flash for about 10 seconds.
- The time display does not appear during fast forward winding (FF) or rewinding (REW) of the tape.

CAUTION

The linear tape counter and remaining tape counter of this unit are set in accordance with the selected tape size [C-90] [C-75] [C-60] or [C-100].

When using a tape of a special size, select the TAPE SIZE which is nearest to that of the used tape. (The tape counter error will then be smaller.)

Note also that the linear tape counter and remaining tape counter do not work as accurately as a clock. Small deviations may occur because the thickness of the tape differs depending on the type (position, tape length) of the used cassette. Slight errors may also be caused by the difference between cassettes with a large hub and cassettes with a small hub.

2) Operation of MEMORY STOP

- (1) During recording or playback operations, MEMORY STOP can be used to locate a particular point on the tape. At the desired point, reset the counter to "00.00". With the MEMORY STOP button in the "ON" position, the deck will stop at the "00.00" point (actually "-00.02" and "00.00") during REWIND operations.
- (2) The MEMORY indication will light when this function is activated.
- (3) Notes:
 - When the power is turned "OFF", this function is automatically deactivated.
 - The MEMORY STOP is accurate to -5 on the counter, and will stop between "-00.02" and "00.00".
 - The MEMORY STOP is released by pressing the EJECT button.
 - The MEMORY STOP does not operate during the REC RETURN.

3) Display Back-up

- (1) The functions DOLBY NR, MPX FILTER, MONITOR TAPE SIZE and the counter content are protected by 24-hour memory back-up. After 24 hours, DOLBY NR and MPX FILTER are set to "OFF", MONITOR is reset to "TAPE", TAPE SIZE is set to "C-90" and the counter content is reset to "00.00".

TROUBLESHOOTING

Check the following before you draw the conclusion that your Stereo Cassette Deck is malfunctioning.

1. Are all the connections correct?
2. Are all system components being operated correctly in accordance with the operating instructions?
3. Are the speakers and amplifier/receiver functioning correctly?

If the tape deck still does not function properly, check the symptom against the list below. If the symptom does not correspond to the check list, please contact your DENON dealer.

Problem	Cause	Remedy
Tape does not run.	<ul style="list-style-type: none"> • Power cord is disconnected. • Tape is loose. • Cassette is not loaded properly. • Defective cassette. 	<ul style="list-style-type: none"> • Check power cord. • Tighten tape with a pencil, etc. • Load cassette properly. • Replace cassette.
Tape is not recorded when REC/REC MUTE (●) button is pressed.	<ul style="list-style-type: none"> • No cassette is loaded. • Erase prevention tabs are broken off. 	<ul style="list-style-type: none"> • Load cassette. • Cover holes with adhesive tape.
Sound is warbled and distorted.	<ul style="list-style-type: none"> • Heads, capstan or pinchroller are dirty. • Tape is wound too tight. • Recording input level is too high. • Tape is worn out and has "drop-outs". 	<ul style="list-style-type: none"> • Clean them. • Fast forward or rewind to loosen tape winding. • Adjust recording input level. • Replace tape.
Excessive noise.	<ul style="list-style-type: none"> • Tape is worn. • Heads, capstan or pinchroller are dirty. • Heads are magnetized. • Recording input level is too low. 	<ul style="list-style-type: none"> • Replace them. • Clean them. • Demagnetize heads. • Adjust recording input level.
High frequency range (treble) is emphasized.	<ul style="list-style-type: none"> • Dolby NR switch is set improperly. 	<ul style="list-style-type: none"> • Set Dolby NR Switch properly.
High frequency range (treble) is lost.	<ul style="list-style-type: none"> • Head are dirty. • Tape is worn. 	<ul style="list-style-type: none"> • Clean them. • Replace tape.

* Above specifications and design are subject to change without prior notice.

Best result will be obtained with use of DENON DX and HD Series Cassette tapes.

Dolby noise reduction and HX PRO headroom extension systems manufactured under license from Dolby Laboratories Licensing Corporation. HX PRO originated by Bang & Olufsen.

"DOLBY" and the double-D symbol  and "HX PRO" are trademarks of Dolby Laboratories Licensing Corporation.

TIMER RECORDING/PLAYBACK

Timer recording/playback can be made using any audio timer available on the market.

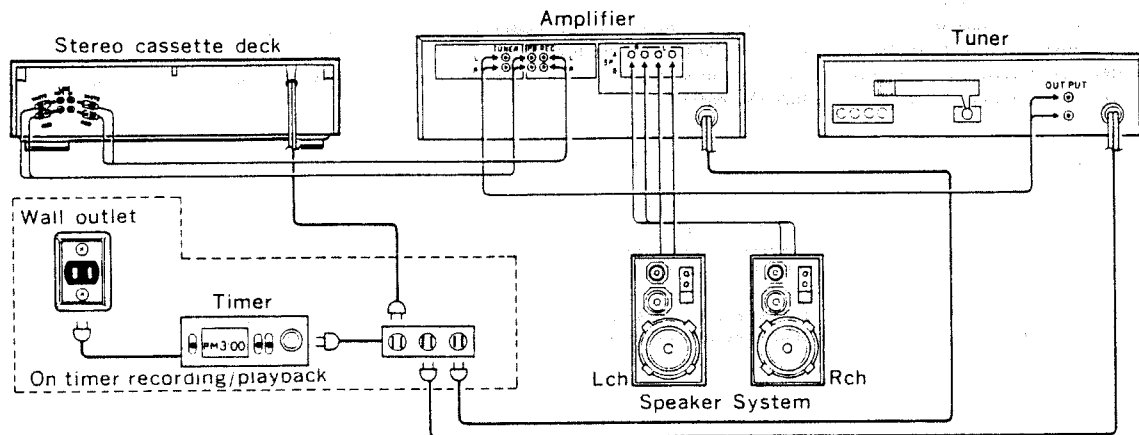

● Timer recording procedure

1. Make sure the connections are correct, especially the power supply connections.
2. Turn "on" the power switch of each appliance.
3. Tune the desired station on the tuner.
4. Load the tape for recording. (Make sure the erase prevention tab is not broken off; if it is, cover the hole with plastic tape).
5. Set the Dolby NR switch to the appropriate position.
6. Make sure the monitor switch to the SOURCE position.
7. Adjust the recording input level.
8. Set the starting position of the tape.
9. Set the timer switch (TIMER) to the "rec" side.
10. Set the audio timer to the desired time. The audio timer will turn the power supply on at the desired time.

*With the above procedures, timer controlled recording can be made. When the preset time comes, the power is supplied and the FM broadcast can be recorded.

● Timer playback procedure

1. Make sure the connections are correct, especially the power supply connections.
2. Turn "on" the power switch of each appliance.
3. Load the pre-recorded tape to be played back.
4. Set the Dolby NR switches to the appropriate positions.
5. Set the monitor switch of the Amplifier to the TAPE (■) position.
6. Press the PLAY (▶) button and playback the tape; adjust the playback level.
7. Set the timer switch (TIMER) to the "play" side.
8. Set the audio timer to the desired time. The audio timer will turn the power supply on at the desired time.

*With the above procedures, timer playback can be accomplished. When the preset time comes, the power is supplied and playback will start.

Note :

- Please read the operating instructions for the timer before use.
- If the timer recording or playback is not desired, be sure to switch the timer switch (TIMER) to "off".
- When using timers that allow several "on/off" operations, timer start functioning can continue an unlimited number of times until the tape in the machine is finished.

BLOCK DIAGRAM

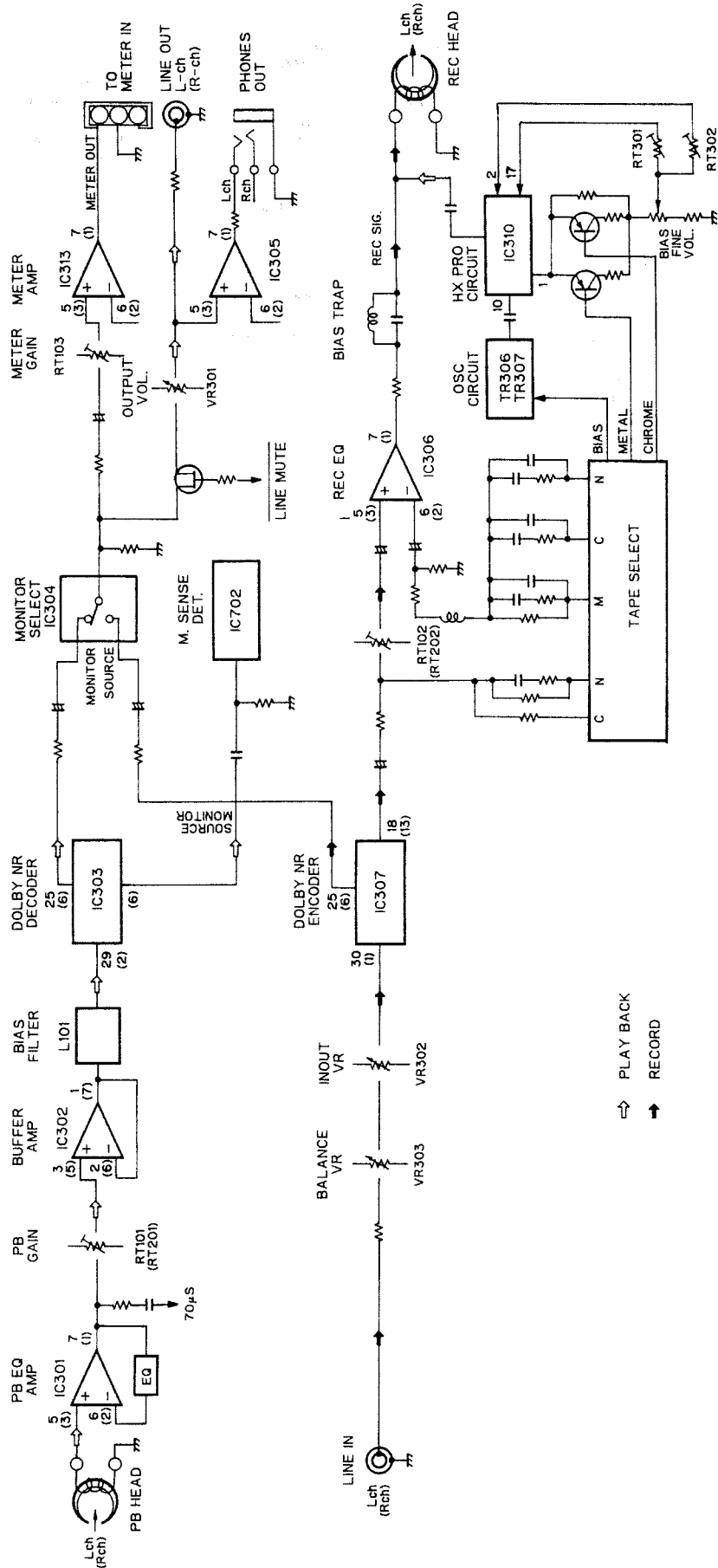

SPECIFICATIONS

Type	Horizontal tape loading; 4-track 2-channel stereo cassette deck	Input LINE	80 mV (-20 dBm) input level at maximum Input impedance: 50 kohm unbalanced
Heads	Record & Playback (combination head) × 1 Erase (Double gap ferrite head) × 1	Output LINE	620 mV (0dB) output level at maximum (with 47 kohm load, recorded level of 200 pwb/mm)
Motors	Capstan (DC servo motor) × 1 Reel (DC motor) × 1 Actuator (DC motor) × 1	PHONES	1.2 mW output level at maximum (optimum load impedance 8 ohm ~ 1.2 kohm)
Tape Speed	4.8 cm/sec.	Accessories	Parallel pin cord × 2
Fast Forward, Rewind Time	Approx. 100 sec. with a C-60 cassette	Power Supply	50 Hz/60 Hz, voltage is shown on rating label
Recording Bias	Approx. 105 kHz	Power Consumption	15 W
Overall S/N Ratio (at 3% THD level)	Dolby C NR on: more than 75 dB (CCIR/ARM)	Dimensions	434 (W) × 122 (H) × 320 (D)mm (17-8/32" × 4-51/64" × 12-19/22")
Overall Frequency Response	20~20,000Hz ± 3 dB (at -20 dB, Metal tape)	Weight	6.6 kg
Channel Separation	More than 40 dB (at 1 kHz)		
Crosstalk	More than 65 dB (at 1 kHz)		
Wow & Flutter	0.038% wrms (JIS method), ±0.1% w. peak		

DISASSEMBLY INSTRUCTIONS

1. Removing the front panel Ass'y

1-1 Turn on power and move the cassette tray out of the front of the set. Turn off the power and remove the loader panel from the front of the unit.

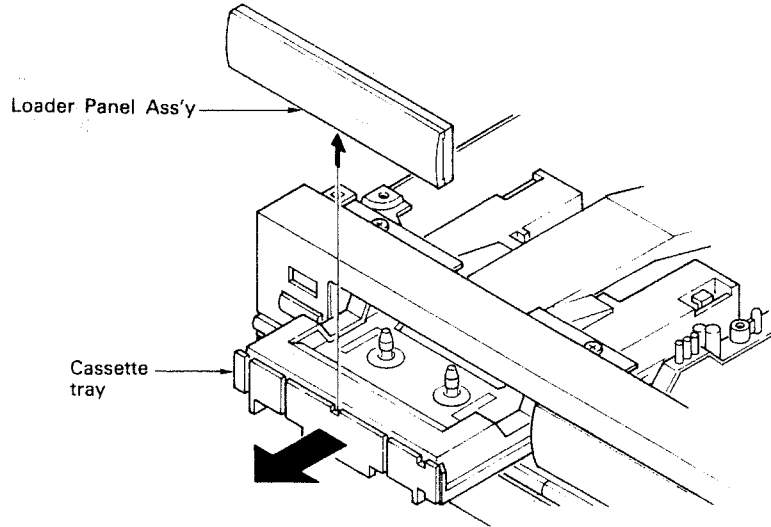

1-2 Remove the four screws (4 X 8CBTS(S)-B) from the side of the top cover, the four screws (3 X 8CBTS(S)-B) from the top of the top cover and one screw (3 X 8CBTS(S)-B) from the rear side. Raise the top cover and lift it towards the rear of the unit to detach it.

rear side. Raise the top cover and lift it towards the rear of the unit to detach it.

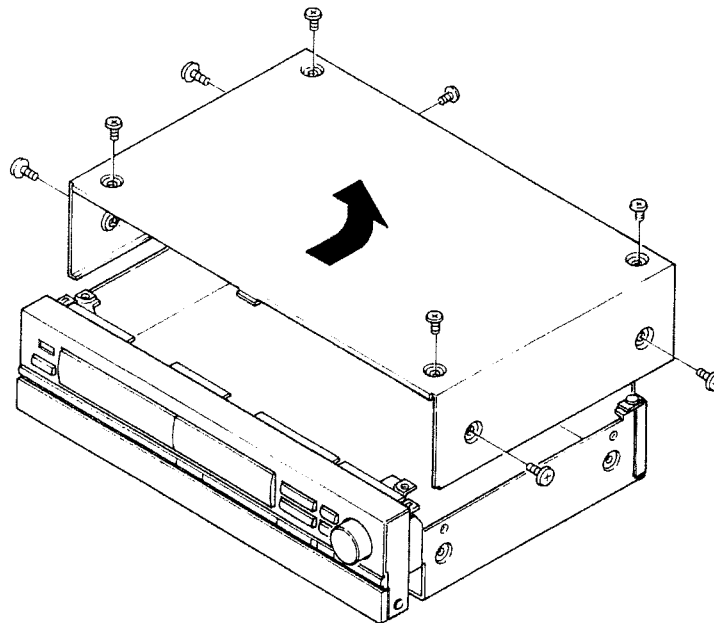

1-3 Disconnect lead connectors.

Key/Meter circuit board	$\left\{ \begin{array}{l} \text{W181 (25P)} \rightarrow \text{CN182} \\ \text{W111 (12P)} \rightarrow \text{CN111} \\ \text{W113 (5P)} \rightarrow \text{CN113} \\ \text{W112 (3P)} \rightarrow \text{CN112} \end{array} \right\}$	Audio circuit board

LEVEL DIAGRAM

PLAYBACK SYSTEM

TCC-130 DOLBY B-TYPE
400 Hz 200 nwb/m

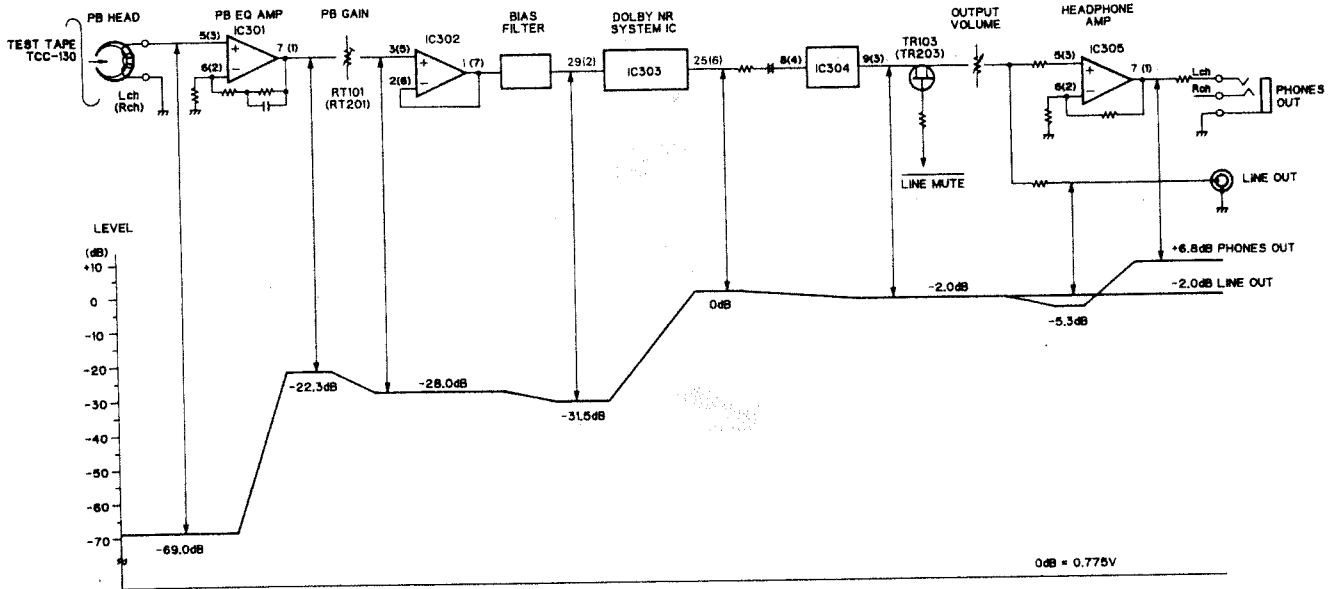

RECORDING SYSTEM

INPUT FREQUENCY
400 Hz

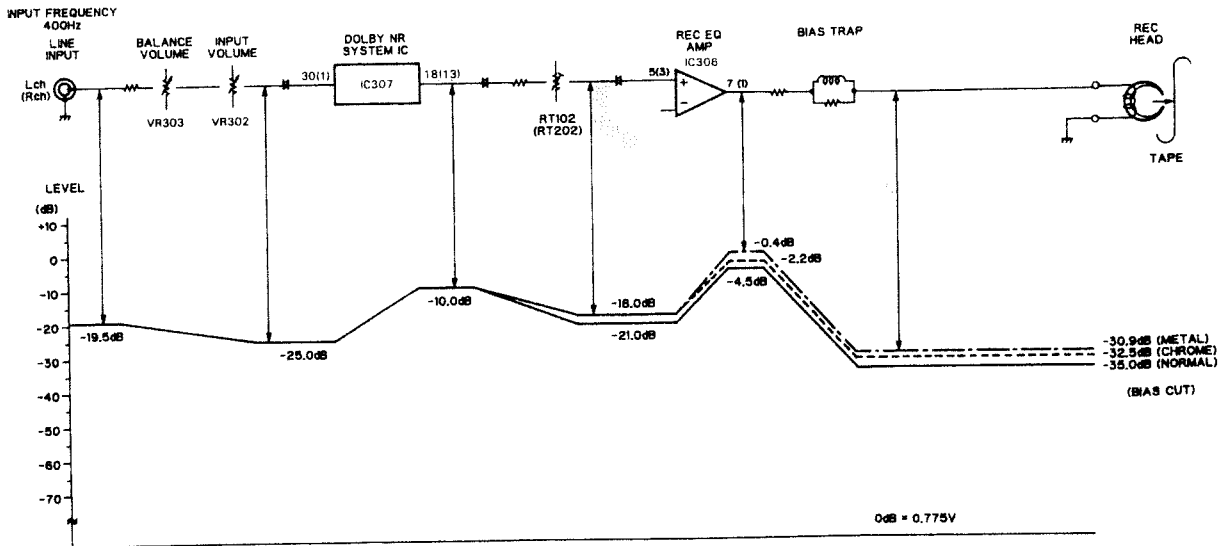

ADJUSTING AND CHECKING THE MECHANISM SECTION

1. Exchanging pinch roller

Before exchanging the pinch roller, clean the tape contact surfaces of the pinch roller and of the capstan shaft.

Defects on tape playing are primarily caused by a dirty pinch roller or capstan shaft.

The right pinch roller arm (4) can be detached by removing the washer (28). The left pinch roller arm (20) can be taken out by removing The spring (26) and the nylon nut (37).

After exchanging the pinch roller, run a tape without a C-90 butt and verify that no tape curling occurs at the tape guide (20) and the tape guide part on the record/playback head.

Normal condition

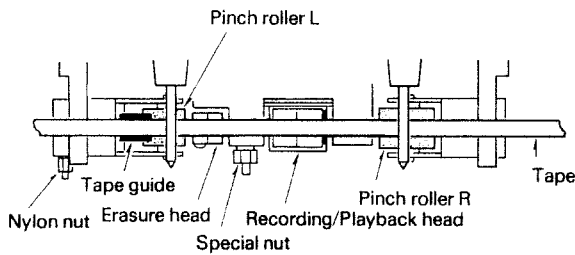

Defective running condition

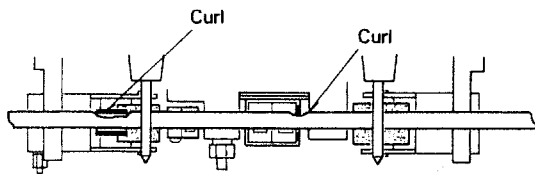

2. Verifying pinch roller crimping

In the playback condition, hook a stick type spring balance to the bracket on the central axis of the pinch roller. After pulling the pinch roller away from the capstan shaft, let the pinch roller contact the capstan shaft as it is and verify that the readings on the stick type spring balance are 250 to 350 g on the right side and 70 to 150 g on the left when the pinch roller starts turning. If the readings exceed the standard values, replace spring (26) or right pinch roller (4).

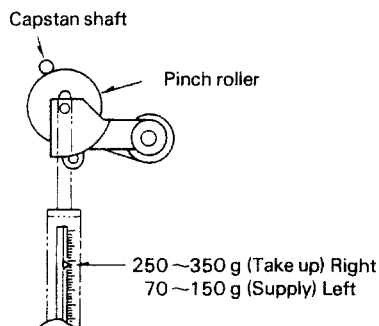

3. Exchanging recording/playback head (77)

Detach the front panel first.

3-1 Dismounting recording/playback head

- (1) Detach the recording/playback head locking screw (74).
- (2) Remove soldering on the head wire and separate the mechanical unit to dismount the recording/playback head.

3-2 Recording/playback head installation

Assembly is the reverse of the installation procedure described in section 3-1. The soldering for the head wire is performed as shown in following Figure.

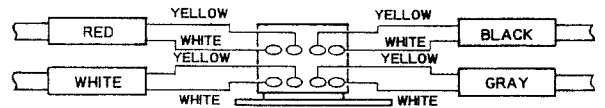
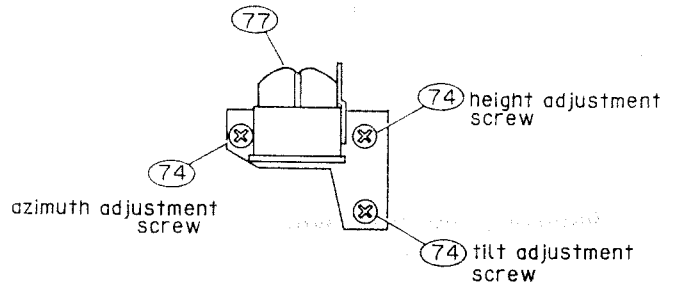

4. Recording/playback head Adjustment

4-1 Height adjustment (adjust with head adjustment jig THG-801)

- (1) Set THG-801 (jig board) on the mechanical unit and perform the adjustment by turning the special height adjustment screw (74) so the 3.8 mm part on THG-801 (lig shaft) can move without touching the tape guide on the recording/playback head (77).
- (2) Turn the azimuth adjusting screw (74) so that the recording/playback head does not tilt while adjusting the height, and make a rough visual adjustment.

4-2 Adjustment of tilt angle

- (1) Set THG-801 (jig board) in the mechanical unit and place THG-801 (jig shaft) on the recording head to inspect the gap between the jig board. If the jig shaft is tilted forward, the tilt screw (74) is too tight. Loosen it slightly and adjust the tilt screw (74) until the jig stick is parallel to the jig board and the gap is completely eliminated.
- (2) Readjusting the tilt may cause the height adjustment to slip. After adjusting the tilt, be sure to verify the height.

If the height is misaligned, turn the special height adjustment screw (74) and the tilt screw (74) to the same angle to shift the recording/playback head so it is parallel to the jig board for height readjustment. After the adjustment is completed, tighten the lock nuts.

1-4 Pull the input knobs away from the front of the unit to remove them.
Remove the three screws (3 × 8CBTS(S)-B) from the upper

section of the panel, three hooks from the bottom of the panel and three hooks from the top of the panel. Pull the front panel away from the unit to remove it.

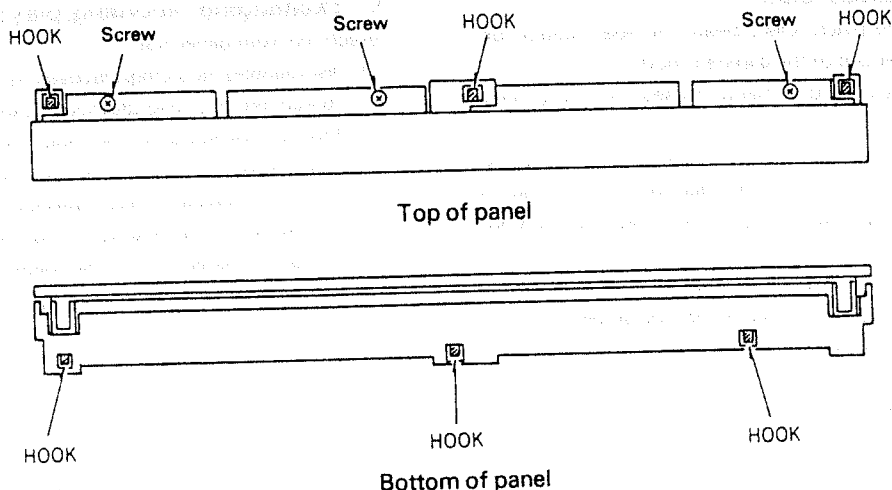

2. Removing the front panel

Remove the seven hooks from the top section of the subpanel.
Raise the front panel to remove it from the main unit.

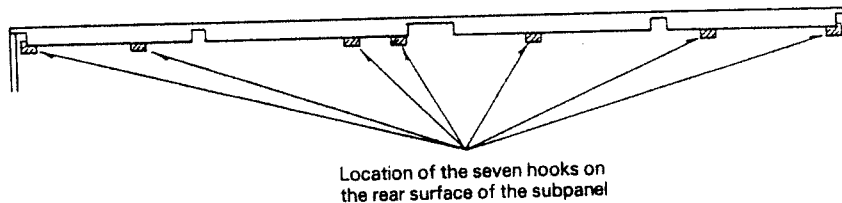

Location of the seven hooks on the rear surface of the subpanel

3. Remove the mecha. assembly (HM100A)

3-1 Disconnect lead connectors

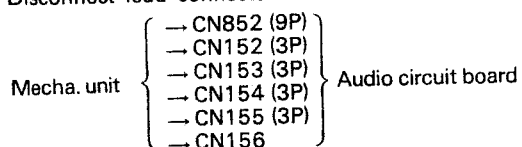

3-2 Remove the four mounting screws (3 × 8CBTS(S)-B) that secure the meche unit and then detach the mecha unit.

Note: When the loader panel and the four screws (3 × 8 CBTS (P)-B) are removed, the mechanism unit can be removed without removing the front assembly. To do so, first lift the back of the mechanism unit, then detach first the right front side then the left front side from the chassis.

4. Remove the cassette mechanism

Remove the four mounting screws (3 × 10CBTS(P)-B) that secure the cassette mechanism and then detach the cassette mechanism.

5. Remove the meter circuit board

Pull the meter circuit board and remove it.

Note: When replacing the tact switch, check to make sure that it is not floating above the circuit board. If it is floating, the switch will be in the on condition when the set is assembled.



6. Remove the audio circuit board

6-1 Remove the connectors with lead wires which run from the audio circuit board and the connectors on top of the audio circuit board.

6-2 Remove the seven screws (3 × 8CBTS(S)-B) that secure the audio circuit board and the 4P pin jack mounting screw (3 × 10CBTS(P)-B) on the back panel. Remove the audio circuit board.

Note: The audio circuit board can be lifted with the power- turned on by doing only step 6-2.

7. Remove the power supply circuit board

Remove the five screws (3 × 8CBTS(S)-B) that secure the power supply circuit board, remove the bushing from the chassis and then remove the power supply circuit board.

ADJUSTING AND CHECKING THE ELECTRICAL SECTION

● **Caution on adjusting**

- (1) Before adjusting, clean the head surface, capstan and the pinch roller with a gauze or a cotton swab moistened with alcohol.
- (2) Demagnetize the R/P HEAD and the E. HEAD with a head eraser.
- (3) Completely demagnetize the adjustment screwdriver.
- (4) Unless instructed otherwise, set the various controls as follows.
 - INPUT volume maximum
 - DOLBY NR switch OFF
 - BIAS FINE volume Center click position
 - BALANCE volume Center click position

1. Tape Transport Check

Load the transport check cassette. In the operational mode, illuminate the fixing guides of the R/P HEAD with a lamp and check to make sure the tape edge does not come in contact with the tape guide section.

The tape transport is the most important element in determining the performance of a cassette deck.

Avoid moving the various adjustment screws, nuts, etc., as much as possible. Refer to the pages on "Adjusting and Checking the Mechanism Section" when replacing or adjusting the R/P HEAD.

2. Adjusting the Azimuth

- (1) After completing the tape transport check, load the test tape (A-BEX TCC-153). **Fig. 2-1**
- (2) Playback (both FWD side and REV side) the test tape; adjust the azimuth screw so that section A of the resurge wave form is maximum and section B is minimum. **Fig. 2-2**

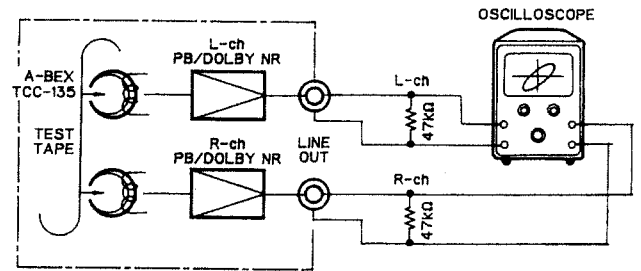

Fig. 2-1

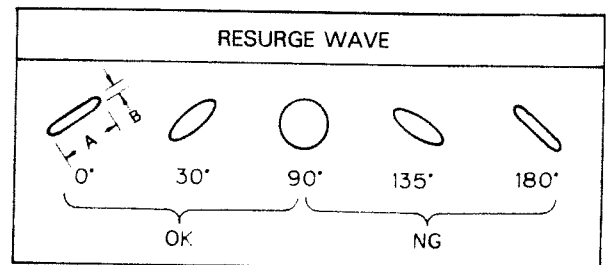

Fig. 2-2

EQUIPMENT FOR ADJUSTING AND CHECKING

1) MEASURING TAPE	TYPE NAME	BRAND	USES
TW-2111A/2121A	SONY	Checking the Take-up Torque and Back Tension.	
TY-2231	SONY	Checking the FF and REW Torque.	
HD-7E/60	DENON	Checking the FF and REW Times.	
TCC-153	A-BEX	Adjusting the Azimuth.	
TY-224	SONY	Checking and Adjusting the Tape Speed	
TCC-130	A-BEX	Adjusting the Playback Level.	
TCC-162/262B	A-BEX	Checking the Playback Frequency Response.	
TCC-902	A-BEX	Transport checking cassette tape.	

(2) MEASURING INSTRUMENT

- Tension gauge
- Audio signal generator
- Variable resistance attenuator
- Electronic voltmeter
- Oscilloscope
- Frequency counter
- Adjustment screwdriver
- Trap coil adjustment square stick

4-3 Azimuth Adjustment

Playback test tape A-BEX TCC-153 and perform the adjustment by turning the azimuth adjustment screw (74) until A and B in the Lissajous wave figure are at the maximum and the minimum positions respectively. After azimuth adjustment is completed, check again to make sure there is no dislocation on the head height with the readjusting jig THG-801. After the adjustment is completed, secure the lock nuts on adjusted parts.

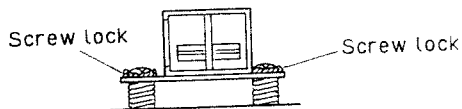
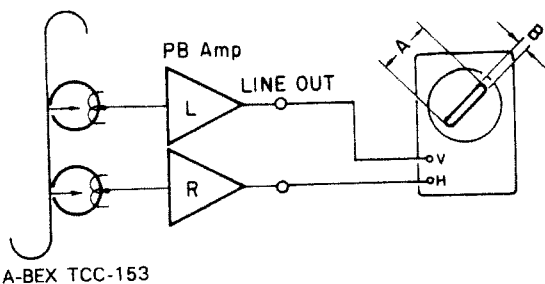
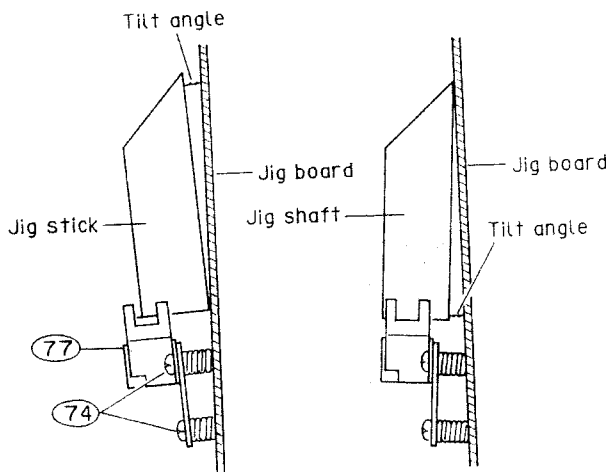

5. Erasure Head (78) Exchange

- 5-1 Remove the locking screw (74) for the erasure head.
- 5-2 Remove the solder on the head wire, and separate the mechanical unit to dismount the erasure head.

6. Checking the Take-up Torque

Load the cassette type torque meter FWD side REV side SONY TW2111A SONY TW2121A. Check to make sure that the average torque meter reading is within 30~70 g-cm during playback. If it is not within this range, check the voltage (approx. 4V) of the reel motor. After the verification, replace the reel motor (80) if there is no problem with the voltage value.

7. Checking the FF and REW Torques

Load the cassette type torque meter (SONY TW2231). Check to make sure the torque meter indicates within 90~180 g-cm at the end of FF and REW.

8. Checking the Back Tension Torque During Record/Playback

Load the cassette type torque meter SONY TW2111A check to make sure the torque meter reads between 6~12 g-cm during playback and that there is no unevenness. If it is not within this range, replace the reel base blk (81) (82) or washer (84).

9. Checking the FF and REW Times

Load a C-60 cassette tape (DENON HD7E/60); check to make sure the tape is fast forwarded or rewound within 100 seconds. If it is not within this range, check sections 5 and 6.

10. Checking the Operation of the Erase Prevention, Metal and Chrome Switch

Confirm that the sensor arm properly detecting the tape type detection holes on the cassette housing.

3. Checking and Adjusting the Tape Speed

- Connect the frequency counter to the LINE OUT terminal and load test tape (SONY TY-224).
- Playback (both FWD side and REV side) a test tape. At about halfway through the tape, where the tape transport is stable, adjust RT-501 so that the frequency counter will have a reading within the range of 3,000Hz \pm 15Hz.

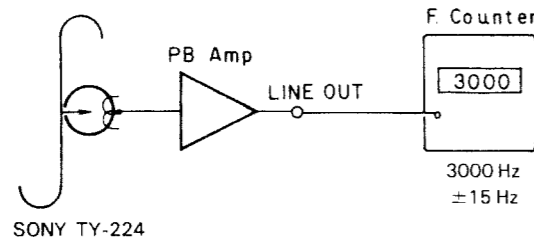

4. Adjusting the Playback Section

- Adjusting the playback level
Playback the Dolby standard level test tape (A-BEX TCC-130) and adjust RT-101 (L ch), RT-201 (R ch) so that the LINE OUT voltage becomes -2 dB (620 mV).

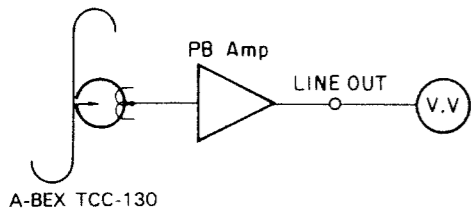

- Adjusting the playback frequency response
Playback the test tape (A-BEX TCC-262B/162B) and check to make sure that the frequency response meets the specifications in the diagram.

Note: Before checking the playback frequency response, first adjust the azimuth using the 8 kHz signal at the beginning of the test tape (A-BEX TCC-262B). Also, after checking the playback frequency, make sure to readjust the azimuth with the test tape (A-BEX TCC-153) and then lock the adjustment screw.

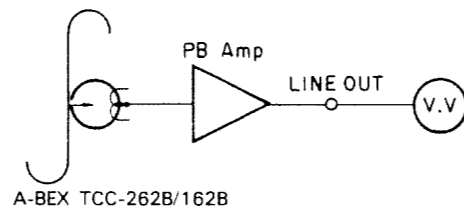

Playback Frequency Response

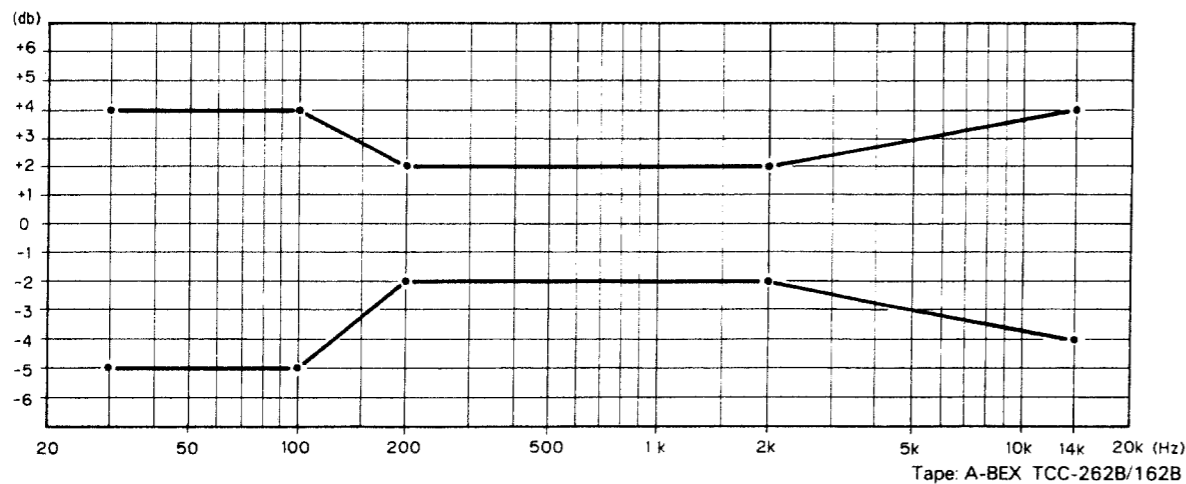

5. Adjusting the Recording Section

- Adjusting the record/playback overall frequency response (CrO₂)

- Load the test tape HD7E/60, record a signal with an input level of -40 dB, 1 kHz at the LINE IN terminal; playback this recording.
- Change the frequency of the input signal to 10 kHz, record and playback; adjust RT-308 (L ch), RT-309 (R ch) so that the characteristic standards meet the following diagram when compared to the 1 kHz signal output level.
(The other TAPE POSITIONS will automatically be adjusted by finishing of the foregoing adjustments.)

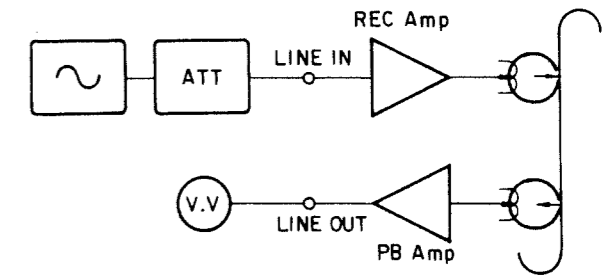

Record/Playback Overall Frequency Response

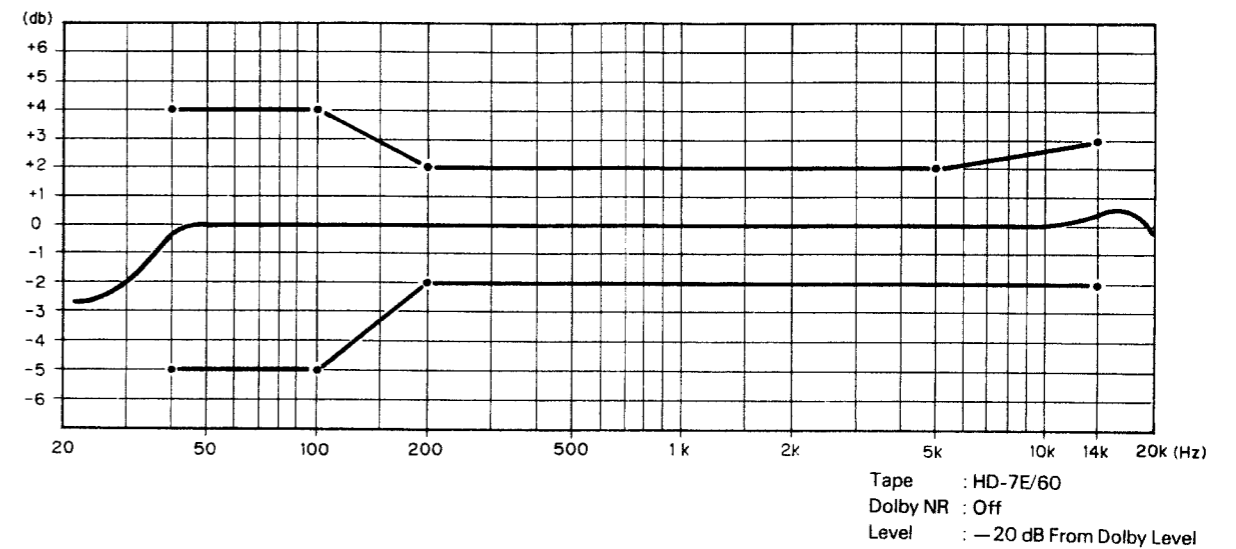

- Adjusting the record/playback levels (CrO₂)

- Load a HD7E/60 tape and after having recorded a signal of 1 kHz (-20 dB), play it back.
- Adjust RT-102 (L ch) and RT-202 (R ch) so that the output from the line out terminal has the same value as the output when monitoring the recording.

- Checking the Dolby C record/playback overall frequency response

- Set the DOLBY NR switch to the "C" position.
- Using the test tapes HD7E/60, perform record/playback in the same manner as 5-(1).
- Check to make sure that the record/playback overall frequency response meets the specifications in the diagram.

Dolby C Record/Playback Overall Frequency Response

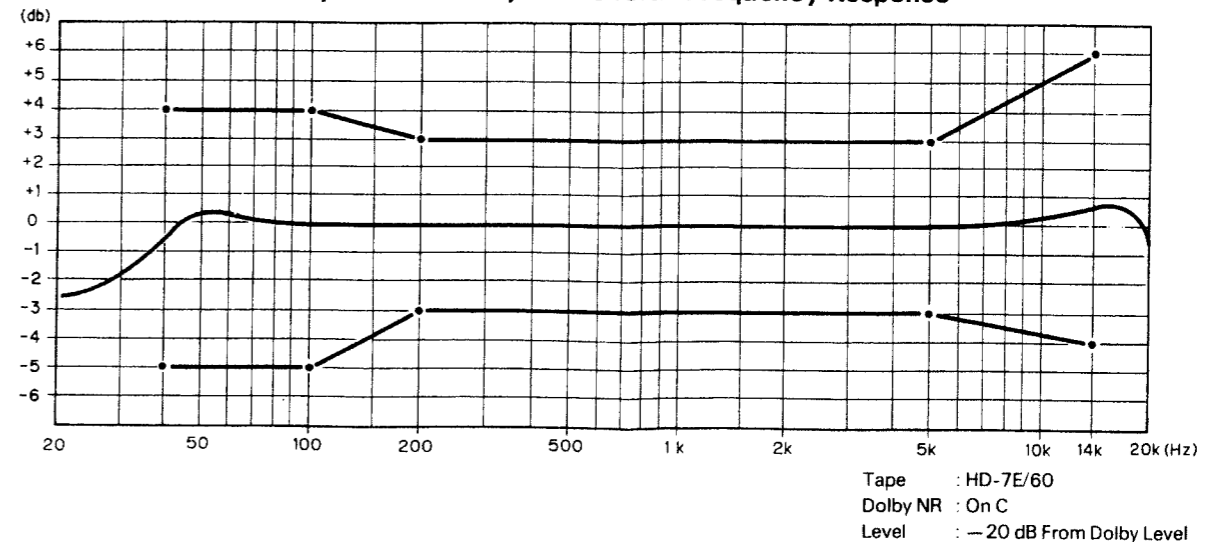

PARTS LIST OF EXPLODED VIEW

Ref. No.	Part No.	Part Name	Remarks	Ref. No.	Part No.	Part Name	Remarks	Ref. No.	Part No.	Part Name	Remarks	
⊙ 1	411 1044 508	CHASSIS		⊙	144 2069 268	FRONT PANEL ASS'Y	(Gold) Asia	56	412 3438 102	LEVER P. ASS'Y		
⊙ 2	105 0936 314	BACK PANEL	Europe	⊙ 25	103 1410 558	FRONT ESC. ASS'Y	(Black)	⊙ 57	203 0288 007	1P CONECT ASS'Y		
⊙	105 0936 330	BACK PANEL	U.K., Australia	⊙	103 1410 561	FRONT ESC. ASS'Y	U.S.A., Canada	58	463 0646 005	LEVER P. SPRING		
⊙	105 0936 327	BACK PANEL	U.S.A., Canada	⊙			(Black)	59	GEN1162	LOADING M. SUB ASS'Y		
⊙	105 0936 356	BACK PANEL	Multi-Voltage (Asia)	⊙	103 1410 574	FRONT ESC. ASS'Y	(Gold) Europe	60	424 0130 008	PULLEY GEAR		
⊙ 3	105 0934 219	BOTTOM COVER		⊙	103 1410 587	FRONT ESC. ASS'Y	(Gold) Asia	61	443 0999 004	COLLAR		
⊙ 4	105 1013 003	BOTTOM PLATE		26	144 1955 014	TRAP DOOR	(Black)	62	423 0050 004	BELT		
5	104 0194 001	FOOT ASS'Y			144 1955 043	TRAP DOOR	(Gold) Europe	63	424 0131 007	GEAR		
⊙ 6	3U 2358 Z	POWER TRANS. P.W.B. UNIT			144 1955 001	TRAP DOOR	(Gold) Asia	64	424 0155 203	CLAMPER CAM		
⚠ 7	233 5756 001	POWER TRANSFORMER	Europe, U.K., Australia	27	401 0121 315	HING (R)	(Black)	65	463 0644 007	CLAMPER A. SPRING		
⚠	233 5758 009	POWER TRANSFORMER	U.S.A.		401 0121 328	HING (R)	(Gold) Europe	66	433 0553 304	CLAMPER ARM		
⚠	233 5759 008	POWER TRANSFORMER	Canada	28	401 0121 302	HING (R)	(Gold) Asia	67	461 0613 003	PAD MARU		
⚠	233 5760 000	POWER TRANSFORMER	Multi-Voltage (Asia)		401 0120 413	HING (L)	(Black)	68	431 0295 200	LOADER FRAME		
⚠ 8	206 2063 009	AC CORD WITH PLUG	Europe		401 0120 426	HING (L)	(Gold) Europe	69	461 0581 009	PAD		
⚠	206 2024 006	AC CORD WITH LABEL	U.K.		401 0120 400	HING (L)	(Gold) Asia	70	424 0158 103	STOPPER CAM		
⚠	206 2061 001	AC CORD	U.S.A., Canada	29	471 9020 018	SPECIAL SCREW	(Black)	71	463 0647 004	STOPPER C. SPRING		
⚠	200 6031 026	AC CORD	Multi-Voltage (Asia)		471 9020 005	SPECIAL SCREW	(Gold) Europe	72	412 3084 200	CAM PLATE		
⚠ 9	212 0286 003	POWER SWITCH			473 7514 001	SPECIAL SCREW	(Gold) Asia	73	424 0157 308	SLIDE CAM (R)		
⚠ 10	445 0056 008	CORD BUSH		30	435 0113 009	LATCH (Y3Y18)		74	424 0156 105	SLIDE CAM (L)		
11	113 1067 238	P. SW LEVER ASS'Y	(Black)	31	421 9007 007	MINI DAMPER		75	431 0319 005	CASSETTE TRAY		
	113 1067 254	P. SW LEVER ASS'Y	(Gold) Europe	32	113 1344 210	OPEN CLOSE BUTTON	(Black)	76	461 0593 000	TRAY PAD		
	113 1067 270	P. SW LEVER ASS'Y	(Gold) Asia		113 1344 223	OPEN CLOSE BUTTON	U.S.A. (Black)	⊙ 77	203 4507 027	3P PH CONNECTOR CORD (BLK)		
⊙ 12	3U 2357 Z	AUDIO/METER P.W.B. UNIT			113 1344 236	OPEN CLOSE BUTTON	(Gold) Europe	⊙ 78	203 4508 026	3P PH CONNECTOR CORD (BLU)		
⊙ 12-1		AUDIO UNIT		33	113 1344 207	OPEN CLOSE BUTTON	(Gold) Asia		⊙ 79	203 4434 006	3P PH CONNECTOR CORD (RED)	
⊙ 12-2		INPUT UNIT			113 1405 010	SERIES BUTTON	(Black)	⊙ 80	203 4736 034	3P PH CONNECTOR CORD		
⊙ 12-3		KEY/METER UNIT			113 1405 023	SERIES BUTTON	U.S.A. (Black)	⊙ 81	204 2371 012	9P KR-KR CON CORD		
⊙ 12-4		TIMER UNIT			113 1405 036	SERIES BUTTON	(Gold) Europe	⊙ 82	204 6330 004	11P KR-KR CON CORD		
⊙ 12-5		REMOTE UNIT			113 1405 007	SERIES BUTTON	(Gold) Asia	85	212 4650 004	LEAF SWITCH		
⊙ 12-6		HEAD PHONE UNIT			113 1224 246	FUNCTION BUTTON	(Black)	86	212 6011 007	LEAF SWITCH		
⊙ 12-7		VOLUME CONTROL UNIT			113 1224 259	FUNCTION BUTTON	U.S.A. (Black)	100	473 7002 021	3 × 8 CBTS (S)-B		
13	204 8254 007	4P PIN JACK			113 1495 004	FUNCTION BUTTON	(Gold) Europe	101	473 7508 017	3 × 10 CBTS (P)-B		
14	499 0150 008	REMOTE SENSOR	SBX1610-52 (IC802)		113 1224 233	FUNCTION BUTTON	(Gold) Asia	102	473 7002 005	3 × 6 CBTS (S)-Z		
15	393 4129 009	FL TUBE	FIP7RM6 (FL801)	35	113 1299 019	MANUAL SEARCH BUTTON	(Black)	103	473 7500 015	3 × 8 CBTS (P)-Z		
16	212 4707 009	SLIDE SWITCH	(SW501)		113 1299 022	MANUAL SEARCH BUTTON	(Gold) Europe	104	477 0242 019	SPECIAL SCREW		
17	204 8264 068	HEAD PHONE JACK	(JK302)		113 1299 006	MANUAL SEARCH BUTTON	(Gold) Asia	105	473 3808 009	3 × 25 CBTS (1)		
	204 8264 000	HEAD PHONE JACK	(Gold) Asia	36	113 1316 112	PAUSE BUTTON	(Black)	106	473 7505 007	2.6 × 8 CBTS (P)-Z		
18	211 0710 000	VOLUME CONT. (INPUT)	V1420H23FA104R (VR302)		113 1316 138	PAUSE BUTTON	(Gold) Europe	107	473 7501 014	3 × 14 CBTS (P)-Z		
19	112 0485 151	VOLUME KNOB (B)	(Black)		112 0676 012	INPUT KNOB ASS'Y	(Black)	108	473 7007 000	4 × 8 CBTS (S)-B		
	112 0485 067	VOLUME KNOB (B)	(Gold) Europe	37	112 0676 025	INPUT KNOB ASS'Y	U.S.A. (Black)					
	112 0485 177	VOLUME KNOB (B)	(Gold) Asia		112 0676 038	INPUT KNOB ASS'Y	(Gold) Europe					
20	211 0711 009	VOLUME CONT. (BIAS)	V11V25FB102K (VR304)		112 0676 054	INPUT KNOB ASS'Y	(Gold) Asia					
21	211 0712 008	VOLUME CONT. (BALANCE)	V11V25FW254- (VR303)	⊙ 38	144 2034 277	LOADER PANEL ASS'Y	(Black)					
22	211 0611 002	VOLUME CONT. (OUTPUT)	V11V25FB103 (VR301)	⊙	144 2177 008	LOADER PANEL ASS'Y	(Gold) Asia					
23	113 0753 006	SLIDE KNOB	(Black)	⊙	144 2034 280	LOADER PANEL ASS'Y	U.S.A. (Black)					
	113 0753 022	SLIDE KNOB	(Gold) Europe	⊙	144 2034 293	LOADER PANEL ASS'Y	(Gold) Europe					
	113 0753 035	SLIDE KNOB	(Gold) Asia	⊙ 39	102 0408 319	TOP COVER						
⊙ 24	144 2069 242	FRONT PANEL ASS'Y	(Black)	⊙	102 0408 306	TOP COVER	(Gold) Europe					
⊙	144 2069 255	FRONT PANEL ASS'Y	(Gold) Europe	⊙	102 0408 225	TOP COVER	(Gold) Asia					
				41	009 0027 006	25P FFC CABLE						
				⊙ 42	412 3375 003	FIX BRACKET						
				⊙ 50	HM1 00C	CASSETTE MECHA UNIT						
				⊙ 51	411 0987 307	MECHA BASE						
				⊙ 52	461 0581 012	PAD						
				53	463 0663 004	CASSETTE SPRING						
				⊙ 54	338 0147 004	CASSETTE MECHA						

- Parts marked with ⚠ and/or shading have special characteristics important to safety. Be sure to use the specified parts for replacement.
- Part indicated with the mark "⊙" are not always in stock and possibly to take long period of time for supplying, or in some case supplying of part may be refused.
- (Gold) in the Remarks column refers with gold front panels, (Black) with black front panels.

EXPLODED VIEW

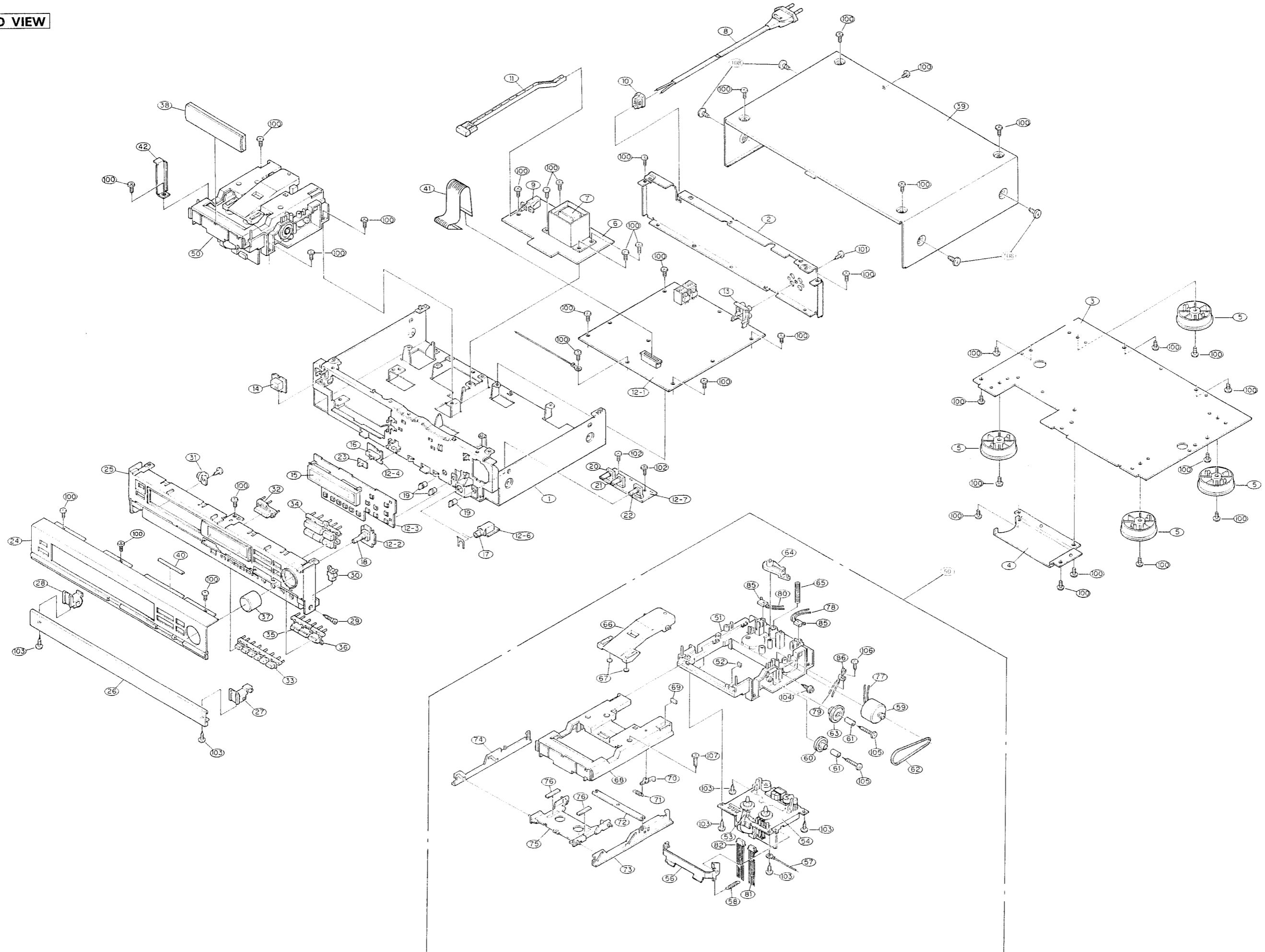

EXPLODED VIEW OF MECHANISM

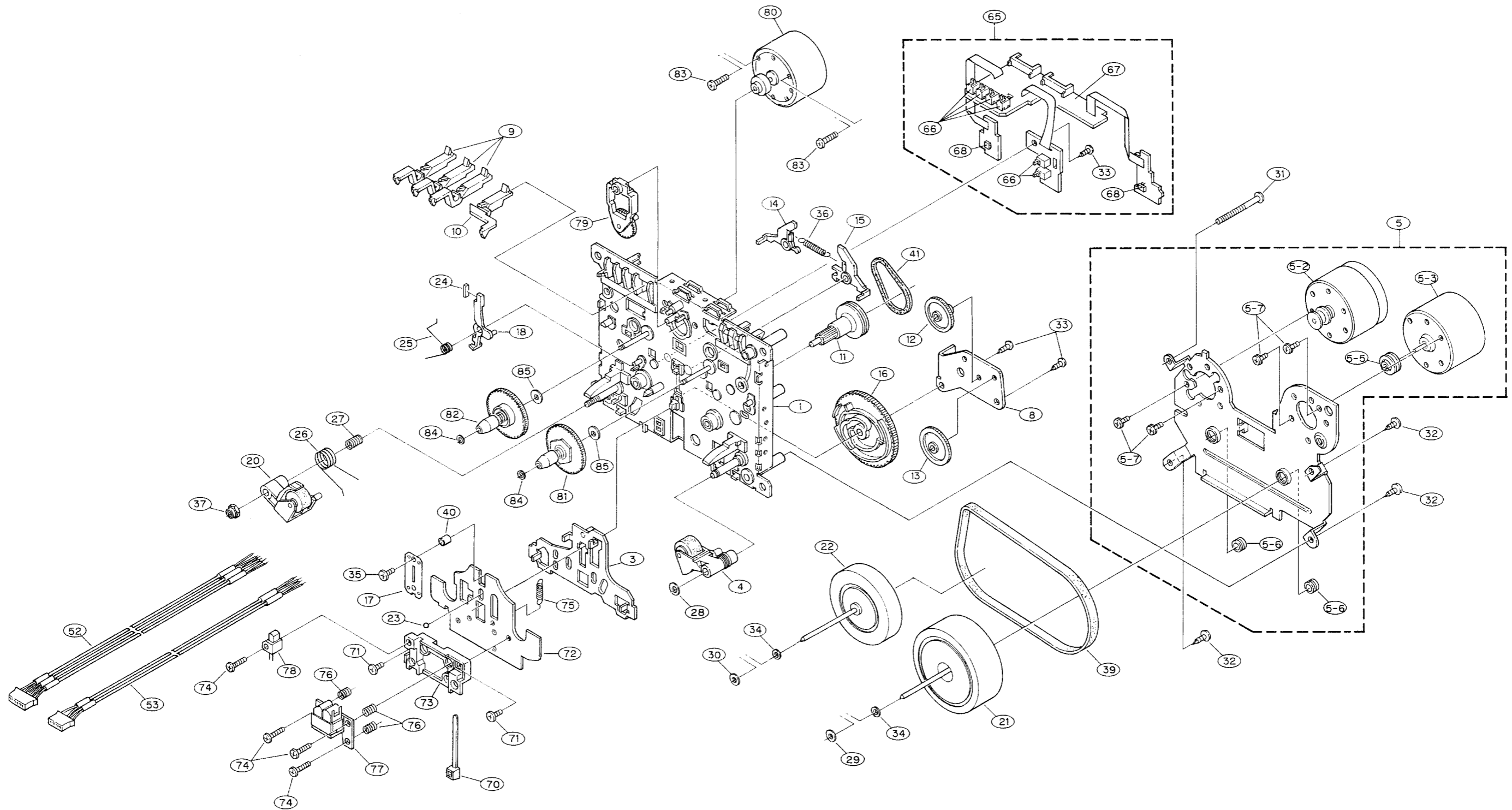

PARTS LIST OF CASSETTE MECHANISM EXPLODED VIEW

Ref. No.	Part No.	Part Name	Remarks
1	9DF 6121 74	CHASSIS BASE BLK	
3	9DF 5121 22	PLATE BASE BLK	
4	9DF 5140 93	PINCH ROLLER BLK	
5	9DF 5252 85	MOTOR MAIN BLK	
5-2	9DF 16B-11	MMI-6H2LWK	
5-3	9DF W15C 11	MMN-6F4RB82	
5-5	9DF D47D 11	PULLEY	
5-6	9DF M177 22	WHEEL CATCH SCREW	
5-7	9DU G11S 14	SCREW 2.6×3.5 ZN	
5-9	9DF J141 12	W/RUMINA 1.9×0/25T	
8	9DF C57H 11	P.C.B. BKT H	
9	9DF D44T 12	REC DETECT LEVER	
10	9DF D44V 14	METAL DETECT LEVER (L)	
11	9DF D48Y 21	GEAR A	
12	9DF D49A 11	GEAR B	
13	9DF D49B 11	GEAR C	
14	9DF D49C 11	BLAKE L	
15	9DF D49R 12	BLAKE R	
16	9DF D48W 12	CAM GEAR H	
17	9DF C57G 12	THRUST SPRING	
18	9DF D49E 14	B.T ARM	
20	9DF R23F 11	PINCH ROLLER	
21	9DF R23D 11	ASS'Y F/W T	
22	9DF R23E 11	ASS'Y F/W S	
23	9DM M113 11	STEEL BALL	
24	9DF Z11Y 12	FELT H	
25	9DF K31A 11	B.T SP	
26	9DF K26S 14	PINCH ROLLER SP(L)	
27	9DF K26V 11	H ADJUST SP	
28	9DF J123 22	W/RUMINA C 3.5×0.25	
29	9DF J141 11A	OIL SHEEL 2.4×0.25	
30	9DF J141 14A	OIL SHEEL 2.15×0.25	
31	9DU G19G 11	S TYTE SCREW M2.6×25	
32	9DU G12H 14	WAVE SCREW 2.6×8 ZN	
33	9DU G12H 11	WAVE SCREW 2.0×6 ZN	
34	9DF J111 30	POLY. WASHER 2.6×0.25	
35	9DU G22B 11	SCREW TT 2.0×7 ZN	
36	9DF K20R 12	BLAKE SP	
37	9DU G20L 12	NYLON NUT	
39	9DF F16M 11	MAIN BELT	
40	9DF L42C 11	SPACER	
41	9DF F18R 11	BELT	
52	9DW H62R 15	HD CABLE (R/E)	
53	9DW H62S 15	HD CABLE (P/B)	
65	9DF 5674 67	PCB CONTROL BLK	
66	9DU E16E 11	PUSH SWITCH	
68	9DA W12M 00	REEL SENSOR	
70	445 0033 005	BUNDOLE BAND	
71	9DK G194 29	SCREW 2.6×5 ZN	
72	9DF C57D 12	HEAD BASE D	
73	9DF D49L 13	HEAD SPACER	
74	9DF G140 26	SCREW 32.0×8 NI	
75	9DF K30W 11	HEAD BASE SP H	
76	9DF K30Y 11	AZIMUS SP H	
77	9DF U19Y 11	H-2371-3108	
78	9DF U20C 11	H.AJAB3523A	
79	9DF 5170 53	IDLER BLK	
80	9DF 5643 02	MOTOR REEL BLK	
81	9DF 6230 37	REEL BASE BLK	
82	9DF 6230 59	REEL BASE BLK	
83	9DU G14C 13	SCREW 2.6×10 ZN	
84	9DF J111 17	WASHER 1.7×0.25	
85	9DU J12V 11	POLY. WASHER 2.1×0.5	

PARTS LIST OF PACKING & ACCESSORIES

Ref. No.	Part No.	Part Name	Remarks
	505 0038 030	POLY COVER	FOR AC CORD
	505 0131 050	CABINET COVER	
	504 0092 060	STYLEN PAPER	
	503 0794 022	CUSHION	
	501 1514 014	CARTON CASE	
	501 1540 017	CARTON CASE	(Gold) Asia
	203 2223 002	2P PIN CORD	
	511 2244 005	INST. MANUAL (E2)	Europe, Canada
	511 2246 003	INST. MANUAL (EU)	U.S.A., U.K.,
			Australia, Asia
	515 0455 005	TAPE CATALOG (E2)	Europe, U.S.A.
	513 9111 001	COLOR LABEL (GOLD)	(Gold) only
△	203 3667 007	PLUG ADAPTER	Multi-Voltage (Asia) only

PARTS LIST OF 3U-2281 MUSIC SENSOR UNIT

Ref. No.	Part No.	Part Name	Remarks
SEMICONDUCTOR GROUP			
IC712	263 0565 007	IC BA15218	
D701 ~707	276 0432 903	Diode 1SS270A TE	
CAPACITOR GROUP			
C702	254 4260 948	Electrolytic 1 μ/50V	CE04W1H010MT
C704 ~708	253 9031 920	Ceramic 0.1 μ/25 V	CK45=1E104KT
C709	253 9030 934	Ceramic 0.0033 μ/25 V	CK45=1E332KT
C710	254 4252 901	Electrolytic 22 μ/10 V	CE04W1A220MT
OTHER PARTS			
CN701	205 0343 045	4P CONN. BASE (KR-PH)	
CN702	205 0343 058	5P CONN. BASE (KR-PH)	
W702	203 8333 006	5P PH-SCN CORD	

PARTS LIST OF 3U-2357 AUDIO METER UNIT

Ref. No.	Part No.	Part Name	Remarks
SEMICONDUCTOR GROUP			
IC301	262 0864 006	IC UPC4570C	
IC302	263 0565 007	IC BA15218	
IC303	263 0715 006	IC CXA1330S	
IC304	262 0276 005	IC HD14066BP	
IC305	263 0711 000	IC M5218AP	
IC307	263 0715 006	IC CXA1330S	
IC308	263 0565 007	IC BA15218	
IC309	263 0565 007	IC BA15218	
IC310	263 0354 001	IC UPC1297CA	
IC311, 312	262 1295 001	IC UPD4094BC	
IC313	263 0565 007	IC BA15218	
IC501	262 0447 009	IC BA6109U1	
IC502	262 1362 002	IC BA6238A	
IC801	262 1534 209	μ Computer UPD75268CW-040	
IC802	499 0150 008	Remote Sensor SBX1610-52	
IC803	263 0620 007	IC BA10393	
IC901	263 0810 008	IC NJM7808FA(S)	
IC902	263 0503 001	IC NJM7908FA	
TR101, 102	273 0245 900	Transistor 2SC2603E/F T	
TR103	275 0048 912	Transistor 2SK381(B)/(C)-T	
TR104	269 0015 908	Digital Tr. DTC124XS (22K-47K)T	
TR105	273 0245 900	Transistor 2SC2603E/F T	
TR106 ~109	269 0015 908	Digital Tr. DTC124XS (22K-47K)T	
TR201, 202	273 0245 900	Transistor 2SC2603E/F T	
TR203	275 0048 912	Transistor 2SK381(B)/(C)-T	
TR204	269 0015 908	Digital Tr. DTC124XS (22K-47K)T	
TR205	273 0245 900	Transistor 2SC2603E/F T	
TR206 ~209	269 0015 908	Digital Tr. DTC124XS (22K-47K)T	
TR301	269 0019 904	Digital Tr. DTA143XS (4.7K-10K)T	
TR302	269 0062 906	Digital Tr. DTC124ES (22K-22K)T	
TR303	269 0015 908	Digital Tr. DTC124XS (22K-47K)T	
TR304	272 0025 907	Transistor 2SB562(C)TF	
TR305	269 0040 902	Digital Tr. DTC144ES (47K-47K)T	
TR306, 307	273 0245 900	Transistor 2SC2603E/F T	
TR308, 309	269 0015 908	Digital Tr. DTC124XS (22K-47K)T	
TR310	269 0018 905	Digital Tr. DTC143ES (4.7K-4.7K)T	
TR311	269 0022 904	Digital Tr. DTA143ES (4.7K-4.7K)T	
TR320	269 0018 905	Digital Tr. DTC143ES (4.7K-4.7K)T	
TR321	269 0022 904	Digital Tr. DTA143ES (4.7K-4.7K)T	
TR330	269 0015 908	Digital Tr. DTC124XS (22K-47K)T	
TR501 ~503	269 0015 908	Digital Tr. DTC124XS (22K-47K)T	

Ref. No.	Part No.	Part Name	Remarks
TR504	269 0090 907	Digital Tr. DTC143XS-T	
TR520	272 0025 907	Transistor 2SB562(C)TF	
TR801, 802	269 0099 908	Digital Tr. DTC143TS (4.7K)T	
D301, 302	276 0432 903	Dinde 1SS270ATE	
D303	276 0468 919	Zener Diode HZS9B-2TD	
D304	276 0432 903	Diode 1SS270ATE	
~307			
D308, 309, 320	276 0468 919	Zener Diode HZS9B-2TD	
D320	276 0049 914	Diode 1S2076ATE	
D501	276 0470 923	Zener Diode HZS11A-3TD	
D502	276 0465 925	Zener Diode HZS7B-3TD	
D503	276 0451 900	Zener Diode HZS2C-1TD	
D504	276 0454 907	Zener Diode HZS3C-1TD	
D505	276 0457 904	Zener Diode HZS4C-1TD	
D506	276 0432 903	Diode 1SS270ATE	
~508			
D509	276 0049 011	Diode 1S2076A	
D801	276 0432 903	Diode 1SS270ATE	
~815			
D817	276 0432 903	Diode 1SS270ATE	
~820			
D821	276 0432 903	Diode 1SS270ATE	
~824			
D825	276 0432 903	Diode 1SS270ATE	
D901	276 0519 907	Diode 1SR35-200AT82	
~904			
D917, 918	276 0519 907	Diode 1SR35-200AT82	
RESISTOR GROUP (not included Carbon Film $\pm 5\%$ 1/4 W type)			
VR301	211 0611 002	Variable 10K ohm (OUTPUT)	V14V25FA103
VR302	211 0710 000	Variable 100K ohm (INPUT)	V1420H23FA104R
VR303	211 0712 008	Variable 250K ohm (BAL.)	V11V25FW254-
VR304	211 0711 009	Variable 1K ohm (BIAS)	V11V25FB102K
RT101	211 6077 954	Adjust 22K ohm	V06PB223
RT102, 103	211 6077 983	Adjust 47K ohm	V06PB473
RT201	211 6077 954	Adjust 22K ohm	V06PB223
RT202, 203	211 6077 983	Adjust 47K ohm	V06PB473
RT301, 302	211 6077 954	Adjust 22K ohm	V06PB223
RT501	211 6077 941	Adjust 5K ohm	V06PB502
R102	247 0011 902	Chip 33K ohm	RM73B--333JT
R104	247 0010 987	Chip 27K ohm	RM73B--273JT
R105	247 0013 984	Chip 470K ohm	RM73B--474JT
R106	247 0008 928	Chip 2.2K ohm	RM73B--222JT
R107	247 0008 944	Chip 2.7K ohm	RM73B--272JT
R108	247 0009 943	Chip 6.8K ohm	RM73B--682JT
R109	247 0009 927	Chip 5.6K ohm	RM73B--562JT
R110	247 0010 974	Chip 24K ohm	RM73B--243JT
R111	247 0006 988	Chip 560K ohm	RM73B--561JT
R112	247 0006 962	Chip 470 ohm	RM73B--471JT
R113	247 0012 927	Chip 100K ohm	RM73B--104JT
R114	247 0009 943	Chip 6.8K ohm	RM73B--682JT

Ref. No.	Part No.	Part Name	Remarks
R116	247 0015 940	Chip 2.2M ohm	RM73B--225JT
R118	247 0012 927	Chip 100K ohm	RM73B--104JT
R119	247 0009 969	Chip 8.2K ohm	RM73B--822JT
R120	247 0011 902	Chip 33K ohm	RM73B--333JT
R121	247 0005 947	Chip 150 ohm	RM73B--151JT
R122	247 0010 987	Chip 27K ohm	RM73B--273JT
R125	247 0008 960	Chip 3.3K ohm	RM73B--332JT
R126	247 0009 969	Chip 8.2K ohm	RM73B--822JT
R127	247 0010 974	Chip 24K ohm	RM73B--243JT
R128	247 0006 988	Chip 560 ohm	RM73B--561JT
R129	247 0007 945	Chip 1K ohm	RM73B--102JT
R130	247 0006 962	Chip 470 ohm	RM73B--471JT
R131	247 0012 927	Chip 100K ohm	RM73B--104JT
R134	247 0009 998	Chip 11K ohm	RM73B--113JT
R135	247 0010 990	Chip 30K ohm	RM73B--303JT
R136	247 0010 961	Chip 22K ohm	RM73B--223JT
R137	247 0008 957	Chip 3K ohm	RM73B--302JT
R138	247 0012 985	Chip 180K ohm	RM73B--184JT
R139	247 0010 987	Chip 27K ohm	RM73B--273JT
R141	247 0005 989	Chip 220 ohm	RM73B--221JT
R142	247 0010 929	Chip 15K ohm	RM73B--153JT
R144	247 0012 927	Chip 100K ohm	RM73B--104JT
R145	247 0010 987	Chip 27K ohm	RM73B--273JT
R146	247 0010 987	Chip 27K ohm	RM73B--273JT
R147	247 0011 986	Chip 68K ohm	RM73B--683JT
R149	247 0014 967	Chip 1M ohm	RM73B--105JT
R150	247 0008 931	Chip 2.4K ohm	RM73B--242JT
R151	247 0010 945	Chip 18K ohm	RM73B--183JT
R202	247 0011 902	Chip 33K ohm	RM73B--333JT
R204	247 0010 987	Chip 27K ohm	RM73B--273JT
R205	247 0013 984	Chip 470K ohm	RM73B--474JT
R206	247 0008 928	Chip 2.2K ohm	RM73B--222JT
R207	247 0008 944	Chip 2.7K ohm	RM73B--272JT
R208	247 0009 943	Chip 6.8K ohm	RM73B--682JT
R209	247 0009 927	Chip 5.6K ohm	RM73B--562JT
R210	247 0010 974	Chip 24K ohm	RM73B--243JT
R211	247 0006 988	Chip 560 ohm	RM73B--561JT
R212	247 0006 962	Chip 470 ohm	RM73B--471JT
R213	247 0012 927	Chip 100K ohm	RM73B--104JT
R214	247 0009 943	Chip 6.8K ohm	RM73B--682JT
R216	247 0015 940	Chip 2.2M ohm	RM73B--225JT
R218	247 1012 926	Chip 100K ohm	RM73B2B104JT
R219	247 0009 969	Chip 8.2K ohm	RM73B--822JT
R220	247 0011 902	Chip 33K ohm	RM73B--333JT
R221	247 0005 947	Chip 150 ohm	RM73B--151JT
R222	247 0010 987	Chip 27K ohm	RM73B--273JT
R225	247 0008 960	Chip 3.3K ohm	RM73B--332JT
R226	247 0009 969	Chip 8.2K ohm	RM73B--822JT
R227	247 0010 974	Chip 24K ohm	RM73B--243JT
R228	247 0006 988	Chip 560 ohm	RM73B--561JT
R230	247 0006 962	Chip 470 ohm	RM73B--471JT
R231	247 0012 927	Chip 100K ohm	RM73B--104JT
R234	247 0009 998	Chip 11K ohm	RM73B--113JT
R235	247 0010 990	Chip 30K ohm	RM73B--303JT
R236	247 0010 961	Chip 22K ohm	RM73B--223JT
R237	247 0008 957	Chip 3K ohm	RM73B--302JT
R238	247 0012 985	Chip 180K ohm	RM73B--184JT
R239	247 0010 987	Chip 27K ohm	RM73B--273JT
R240	247 0009 901	Chip 4.7K ohm	RM73B--472JT

Ref. No.	Part No.	Part Name	Remarks
R241	247 0005 989	Chip 220 ohm	RM73B--221JT
R242	247 0010 929	Chip 15K ohm	RM73B--153JT
R244	247 0012 927	Chip 100K ohm	RM73B--104JT
R245	247 0010 987	Chip 27K ohm	RM73B--273JT
R246	247 0010 987	Chip 27K ohm	RM73B--273JT
R247	247 0011 986	Chip 68K ohm	RM73B--683JT
R249	247 0014 967	Chip 1M ohm	RM73B--105JT
R250	247 1008 930	Chip 2.4K ohm	RM73B2B242JT
R251	247 0010 945	Chip 18K ohm	RM73B--183JT
R303	247 0010 961	Chip 22K ohm	RM73B--223JT
R304	247 0010 987	Chip 27K ohm	RM73B--273JT
R305	247 0007 945	Chip 1K ohm	RM73B--102JT
R306	247 0011 944	Chip 47K ohm	RM73B--473JT
R308	247 0008 986	Chip 3.9K ohm	RM73B--392JT
R309	247 0012 927	Chip 100K ohm	RM73B--104JT
R310	247 0007 903	Chip 680 ohm	RM73B--681JT
R311	247 0012 927	Chip 100K ohm	RM73B--104JT
R312	247 0004 922	Chip 47K ohm	RM73B--470JT
R313	247 0011 999	Chip 75K ohm	RM73B--753JT
R314	247 0012 901	Chip 82K ohm	RM73B--823JT
R315	247 0010 987	Chip 27K ohm	RM73B--273JT
R316, 317	247 0009 985	Chip 10K ohm	RM73B--103JT
R320	247 0009 901	Chip 4.7K ohm	RM73B--472JT
R323, 324	247 0012 943	Chip 120K ohm	RM73B--124JT
R327	247 0006 946	Chip 390 ohm	RM73B--391JT
R328	247 0007 961	Chip 1.2K ohm	RM73B--122JT
R330	247 0007 903	Chip 680K ohm	RM73B--681JT
R331	247 0008 960	Chip 3.3K ohm	RM73B--332JT
R332, 333	247 0010 929	Chip 15K ohm	RM73B--153JT
R336	247 0007 945	Chip 1K ohm	RM73B--102JT
R337	247 0001 967	Chip 3.9 ohm	RM73B--3R9KT
R338	247 0010 987	Chip 27K ohm	RM73B--273JT
R350	247 0009 914	Chip 5.1K ohm	RM73B--512JT
R351	247 0011 944	Chip 47K ohm	RM73B--473JT
R352	247 0015 940	Chip 2.2 M ohm	RM73B--225JT
R503	244 0017 020	Metallic film 10 ohm 1 W (Non-burning type)	RS14B3A100JNBF
R504	247 0010 916	Chip 13K ohm	RM73B--133JT
R505	244 0017 020	Metallic film 10 ohm 1 W (Non-burning type)	RS14B3A100JNBF
R506	247 0008 931	Chip 2.4K ohm	RM73B--242JT
R507	247 0007 945	Chip 1K ohm	RM73B--102JT
~509			
R520	247 0011 944	Chip 47K ohm	RM73B--473JT
R521	247 0007 945	Chip 1K ohm	RM73B--102JT
R530	247 0009 956	Chip 7.5K ohm	RM73B--752JT
R802	244 0009 985	Chip 10K ohm	RM73B--103JT
~805			
R806	247 0012 927	Chip 100K ohm	RM73B--104JT
R807	247 0009 985	Chip 10K ohm	RM73B--103JT
R808	247 0009 985	Chip 10K ohm	RM73B--103JT
R809	247 1009 984	Chip 10K ohm	RM73B2B103JT
R810, 811	247 0009 945	Chip 1K ohm	RM73B--102JT
R812, 813	247 0009 985	Chip 10K ohm	RM73B--103JT
R814	247 0012 927	Chip 100K ohm	RM73B--104JT
R815	247 1012 926	Chip 100K ohm	RM73B2B104JT
R816	244 0009 985	Chip 10K ohm	RM73B--103JT
~819			
R820	247 0009 985	Chip 10K ohm	RM73B--103JT
~822			

Ref. No.	Part No.	Part Name	Remarks
R823	247 0009 901	Chip 4.7K ohm	RM73B--472JT
R824	244 0010 958	Chip 20K ohm	RM73B--203JT
~831			
R832	247 0012 927	Chip 100K ohm	RM73B--104JT
R833	247 0012 927	Chip 100K ohm	RM73B--104JT
R836	244 1009 984	Chip 10K ohm	RM73B2B103JT
R837	244 0011 902	Chip 33K ohm	RM73B--333JT
R838	247 0009 985	Chip 10K ohm	RM73B--103JT
R839	247 0011 902	Chip 33K ohm	RM73B--333JT
R840	247 0009 985	Chip 10K ohm	RM73B--103JT
R907	247 0009 985	Chip 10K ohm	RM73B--103JT
CAPACITOR GROUP			
C101	257 0006 901	Ceramic 390p/50V	CC73SL1H391JT
C103	257 0009 979	Ceramic 0.0056 μ /50V	CK73B1H562KT
C104	254 3056 917	Electrolytic 1 μ /50V Bipolar	CE04D1H010MBPT
C105	257 0010 955	Ceramic 0.027 μ /50V	CK73B1H273KT
C107	254 4278 943	Electrolytic 0.56 μ /50V	CE04W1HR56MT
C108	254 4260 948	Electrolytic 1 μ /50V	CE04W1H010MT
C109, 110	257 0009 924	Ceramic 0.0022 μ /50V	CK73B1H222KT
C111	254 4260 922	Electrolytic 0.33 μ /50V	CE04W1HR33MT
C112	254 4254 909	Electrolytic 10 μ /16V	CE04W1C100MT
C113	254 4258 905	Electrolytic 4.7 μ /65V	CE04W1V4R7MT
C114	254 4260 948	Electrolytic 1 μ /50V	CE04W1H010MT
C115	257 0005 944	Ceramic 220p/50V	CC73SL1H221JT
C118	254 4260 948	Electrolytic 1 μ /50V	CE04W1H010MT
C119	257 0009 908	Ceramic 0.0015 μ /50V	CK73B1H152KT
C120, 121	257 0009 924	Ceramic 0.0022 μ /50V	CK73B1H222KT
C122	254 4278 943	Electrolytic 0.56 μ /50V	CE04W1HR56MT
C123	254 4260 922	Electrolytic 0.33 μ /50V	CE04W1HR33MT

PARTS LIST OF 3U-2358 POWER SUPPLY UNIT

Ref. No.	Part No.	Part Name	Remarks
SEMICONDUCTOR GROUP			
IC903	263 0793 002	IC NJM7806FA (S)	
TR904	272 0025 907	Transistor 2SB562 (C) TF	
TR906	269 0112 908	Digital Tr. DTC144WS (47K-22K)	
D905, 906	276 0519 907	Diode 1SR35-200AT82	
D907	276 0463 914	Zener Diode HZS6C-2TD	
D909	276 0519 907	Diode 1SR35-200AT82	
	~911		
D912	276 0482 924	Zener Diode HZS27-3TD	
D913	276 0472 918	Zener Diode HZS11C-2TD	
D915, 916	276 0553 905	Diode 1SR35-200A (T93X)	
D919	276 0432 903	1SS27OATE (TAPE)	

Ref. No.	Part No.	Part Name	Remarks
CAPACITOR GROUP			
C901	253 8014 702	Ceramic 0.01 μ /400V AC	CK45F2GAC103MC
C908	254 4256 790	Electrolytic 2200 μ /25V	CE04W1E222MC
C909	254 4403 035	Electrolytic 4700 μ /25V	CE04W1E472M
C911	253 9031 917	Ceramic 0.068 μ /25V	CK45=1E683KT
C913	254 4261 756	Electrolytic 470 μ /50V	CE04W1H471MC
C914	254 4258 947	Electrolytic 47 μ /35V	CE04W1V470MT
C915	254 4258 950	Electrolytic 100 μ /35V	CE04W1V101MT
C916	254 4256 952	Electrolytic 220 μ /25V	CE04W1E222M
C920	254 4260 948	Electrolytic 1 μ /50V	CE04W1H010MT
C922	254 4260 951	Electrolytic 2.2 μ /50V	CE04W1H2R2MT

OTHER PARTS			
△SW901	212 0286 003	POWER SWITCH	Multi-Voltage (Asia) only
△SW902	212 3315 023	VOLTAGE SELECTOR	
△F901	206 1031 045	FUSE (0.25 A)	Multi-Voltage (Asia) only
W191	204 6286 022	12P PH-SAN CORD	

NOTE FOR PARTS LIST

- Part indicated with the mark "⊙" are not always in stock and possibly to take a long period of time for supplying, or in some case supplying of part may be refused.
- When ordering of part, clearly indicated "1" and "1" (i) to avoid mis-supplying.
- Ordering part without stating its part number can not be supplied.
- Part indicated with the mark "*" is not illustrated in the exploded view.
- Not including Carbon Film $\pm 5\%$, 1/6 W, 1/4 W Type in the P. W. Board parts list.
- Parts marked with this symbol Δ have critical characteristics. Use ONLY replacement parts recommended by the manufacturer.

Refer to the following table for the codes of the resistors and capacitors appearing on the parts list.

Resistors

Ex.: RN 14K 2E 182 G FR

Type	Shape and performance	Power	Resistance	Allowable error	Others
RD : Carbon	2B : 1/4W	F : $\pm 1\%$	P : Pulse-resistant type		
RC : Fixed	2E : 1/2W	G : $\pm 2\%$	NL : Low noise type		
RS : Metallic film	2H : 1/2W	J : $\pm 5\%$	NB : Non-burning type		
RW : Winding	3A : 1W	K : $\pm 10\%$	FR : Fuse resistor		
RN : Metal film	3D : 2W	M : $\pm 20\%$	F : Lead wire forming		
RK : Metal mixture	3F : 3W				
	3H : 5W				

*** Resistance**

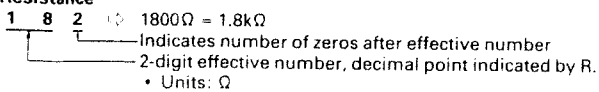

Capacitors

Ex.: CE 04W 1H 2R2 M BP

Type	Shape and performance	Dielectric strength	Capacity	Allowable error	Others
CE : Aluminum foil electrolyte	0J : 6.3V	F : $\pm 1\%$	HS : High stability type		
CA : Aluminum solid electrolyte	1A : 10V	G : $\pm 2\%$	BP : Non-polar type		
CS : Tantalum electrolyte	1C : 16V	J : $\pm 5\%$	HR : Ripple-resistant type		
CQ : Film	1E : 25V	K : $\pm 10\%$	DL : For charge and discharge		
CK : Ceramic	1Y : 35V	M : $\pm 20\%$	HF : For assuring high frequency		
CC : Ceramic	1H : 50V	Z : +80%	U : UL part		
CP : Oil	2A : 100V	-20%	C : CSA part		
CM : Mica	2B : 125V	P : +100%	W : UL-CSA type		
CF : Metallized	2C : 160V	-0%	F : Lead wire forming		
CH : Metallized	2D : 200V	C : $\pm 0.25\text{pF}$			
	2E : 250V	D : $\pm 0.5\text{pF}$			
	2H : 500V	= : Others			
	2J : 630V				

*** Capacity**

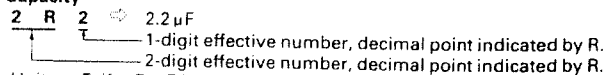

- Units: μF , (for P, pF (μpF))
- When the dielectric strength is indicated in AC, "AC" is included after the dielectric strength value.

Ref. No.	Part No.	Part Name	Remarks
C220, 221	257 0009 924	Ceramic 0.0022 μ /50V	CK73B1H222KT
C222	254 4278 943	Electrolytic 0.56 μ /50V	CE04W1HR56MT
C223	254 4260 922	Electrolytic 0.33 μ /50V	CE04W1HR33MT
C224	257 0005 944	Ceramic 220p/50V	CC73SL1H221JT
C224	254 4254 909	Electrolytic 10 μ /16V	CE04W1C100MT
C225	254 4260 948	Electrolytic 1 μ /50V	CE04W1H010MT
C226	253 1122 905	Ceramic 0.0068 μ /50V	CK45B1H682KT
C227	254 4258 905	Electrolytic 4.7 μ /65V	CE04W1V4R7MT
C228	254 4252 901	Electrolytic 22 μ /10V	CE04W1A220MT
C229	256 1034 966	Metallized 0.082 μ /50V	CF93A1H823JT
C230	257 0008 983	Ceramic 0.001 μ /50V	CK73B1H102KT
C231	257 0005 902	Ceramic 150p/50V	CC73SL1H151JT
C232	253 9030 950	Ceramic 0.0068 μ /25V	CK45=1E682KT
C233	253 1006 005	Ceramic 0.0022 μ /50V	CK45B1H222K
C235	253 1003 008	Ceramic 680p/50V	CK45B1H681K
C236	254 4260 951	Electrolytic 2.2 μ /50V	CE04W1H2R2MT
C237	254 4260 964	Electrolytic 3.3 μ /50V	CE04W1H3R3MT
C238	253 9030 950	Ceramic 0.0068 μ /25V	CK45=1E682KT
C239	254 4254 909	Electrolytic 10 μ /16V	CE04W1C100MT
C301, 302	254 4252 927	Electrolytic 47 μ /10V	CE04W1A470MT
C303	253 1118 906	Ceramic 0.0033 μ /50V	CK45B1H332KT
C304	254 4252 901	Electrolytic 22 μ /10V	CE04W1A220MT
C305, 306	254 4254 909	Electrolytic 10 μ /16V	CE04W1C100MT
C307	254 4256 907	Electrolytic 10 μ /25V	CE04W1E100MT
C308	253 9031 991	Ceramic 0.0082 μ /25V	CK45=1E822KT
C309	257 0010 900	Ceramic 0.01 μ /50V	CK73B1H103KT
C310, 311	257 0009 940	Ceramic 0.0033 μ /50V	CK73B1H332KT
C312	255 4120 900	Film 0.0068 μ /100V	CQ93P2A682JT
C313	257 0002 921	Ceramic 10p/50V	CC73SL1H100DT
C314, 315	257 0010 942	Ceramic 0.022 μ /50V	CK73B1H223KT
C316, 317	257 0011 967	Ceramic 0.033 μ /50V	CK73B1H333KT
C318, 319	257 0010 900	Ceramic 0.01 μ /50V	CK73B1H103KT
C320, 321	257 0006 985	Ceramic 820p/50V	CC73SL1H821JT
C322	253 9031 904	Ceramic 0.047 μ /25V	CK45=1E473KT
C323, 324	253 1131 909	Ceramic 390p/500V	CK45B2H391KT
C325, 326	257 0004 961	Ceramic 100p/50V	CC73SL1H101JT
C331	257 0013 907	Ceramic 0.047 μ /50V	CK73F1H473ZT
C335	254 4254 909	Electrolytic 10 μ /16V	CE04W1C100MT
C340	253 9030 905	Ceramic 0.001 μ /25V	CK45=1E102K
C351	257 0008 983	Ceramic 0.001 μ /50V	CK73B1H102KT
C352	254 4254 909	Electrolytic 10 μ /16V	CE04W1C100MT
C501	257 0010 900	Ceramic 0.01 μ /50V	CK73B1H103KT
-504			
C801	257 1013 951	Ceramic 0.047 μ /25V	CK73B1E473KT
C802	257 1011 908	Ceramic 0.01 μ /50V	CK73B1H103KT
C804	257 0008 983	Ceramic 0.001 μ /50V	CK73B1H102KT
-807			
C817	257 0008 983	Ceramic 0.001 μ /50V	CK73B1H102KT
-820			
C902, 903	254 4403 718	Electrolytic 1000 μ /25V	CE04W1E102MC
C904, 905	254 4252 930	Electrolytic 100 μ /10V	CE04W1A101MT

Ref. No.	Part No.	Part Name	Remarks
C906, 907	257 0014 922	Ceramic 0.068 μ /25V	CK73F1E683ZT
C917	259 0007 715	Electrolytic 4700 μ	SB CAP==472=C
C918	254 4250 796	Electrolytic 4700 μ /6.3V	CE04W0J472MC
C932	253 9031 917	Ceramic 0.068 μ /25V	CK45=1E683KT
C933	257 0014 922	Ceramic 0.068 μ /25V	CK73F1E683ZT
C502	257 0010 942	Ceramic 0.022 μ /50V	CK73B1H223KT
OTHER PARTS			
L101	231 0825 009	BIAS FILTER	BIAS
L102	232 0109 003	MPX FILTER	MPX
L103	235 0020 945	INDUCTOR 153JT	
L104	235 0020 903	INDUCTOR 682JT	
L105	239 0010 009	HX STEP UP COIL	HX
L201	231 0825 009	BIAS FILTER	BIAS
L202	232 0109 003	MPX FILTER	MPX
L203	235 0020 945	INDUCTOR 153JT	
L204	235 0020 903	INDUCTOR 682JT	
L205	239 0010 009	HX STEP UP COIL	HX
L301	231 0078 005	OSC COIL	OSC
XT801	399 0107 007	CST4. 19MGW	CLOCK
SW801	212 4388 907	TACT SWITCH	
-815			
SW816	212 4707 009	SLIDE SWITCH	TIMER
JK301	204 8254 007	4P PIN JACK	LINE IN/OUT
JK302	204 8264 068	HEAD PHONE JACK	
FL801	393 4129 009	FL TUBE (FIP7RM6)	
CN111	205 0375 026	12P CONN.BASE (KR-PH)	
CN112	205 0343 032	3P CONN.BASE (KR-PH)	H/P JACK
CN113	205 0343 058	5P CONN.BASE (KR-PH)	INPUT VR
CN152	205 0323 036	3P CONN.BASE (BLK)	MOTOR
CN153	205 0321 038	3P CONN.BASE (RED)	OPEN
CN154	205 0406 034	3P CONN.BASE (KR-PH)	CLOSE
CN155	205 0543 036	3P CONN.BASE (YEL)	SPEED
CN156	205 0375 013	11P CONN.BASE (KR-PH)	
CN181, 182	205 0491 036	25P FFC CONN.BASE	METER
CN183	205 0355 033	3P KR CONN.BASE (L)	
CN184, 185	205 0343 032	3P CONN.BASE (KR-PH)	
CN191	205 0375 026	12P CONN.BASE (KR-PH)	
CN301	205 0343 045	4P CONN.BASE (KR-PH)	P B HEAD
CN302	205 0343 061	6P CONN.BASE (KR-PH)	R/E HEAD
CN852	205 0343 058	5P CONN.BASE (KR-PH)	INPUT VR
W111	203 6264 015	12P KR-DA CONN.CORD	
W112	203 4753 020	3P KR-DA CONN.CORD	
W113	203 8207 006	5P KR-DA CONN.CORD	
W183	203 4753 017	3P KR-DA CONN.CORD	
W400	203 0389 074	1P CONTACT ASS'Y	
W401	203 0328 006	1P SIN CONN. ASS'Y	
W402, 403	203 0385 094	1P SIN CORD ASS'Y	

P.W. BOARD OF 3U-2357 AUDIO/METER UNIT

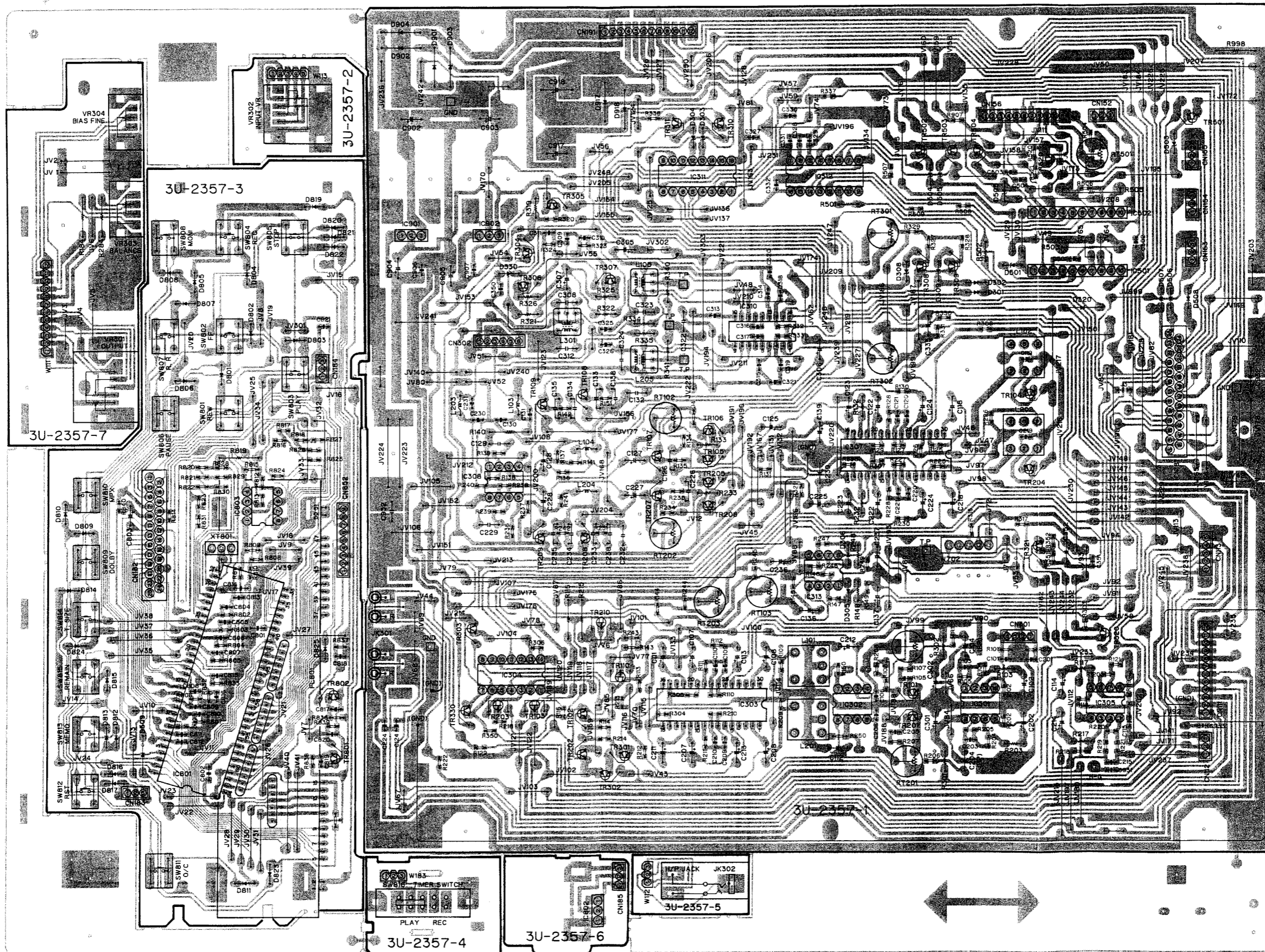

A
B
C
D
E

1 2 3 4 5 6 7

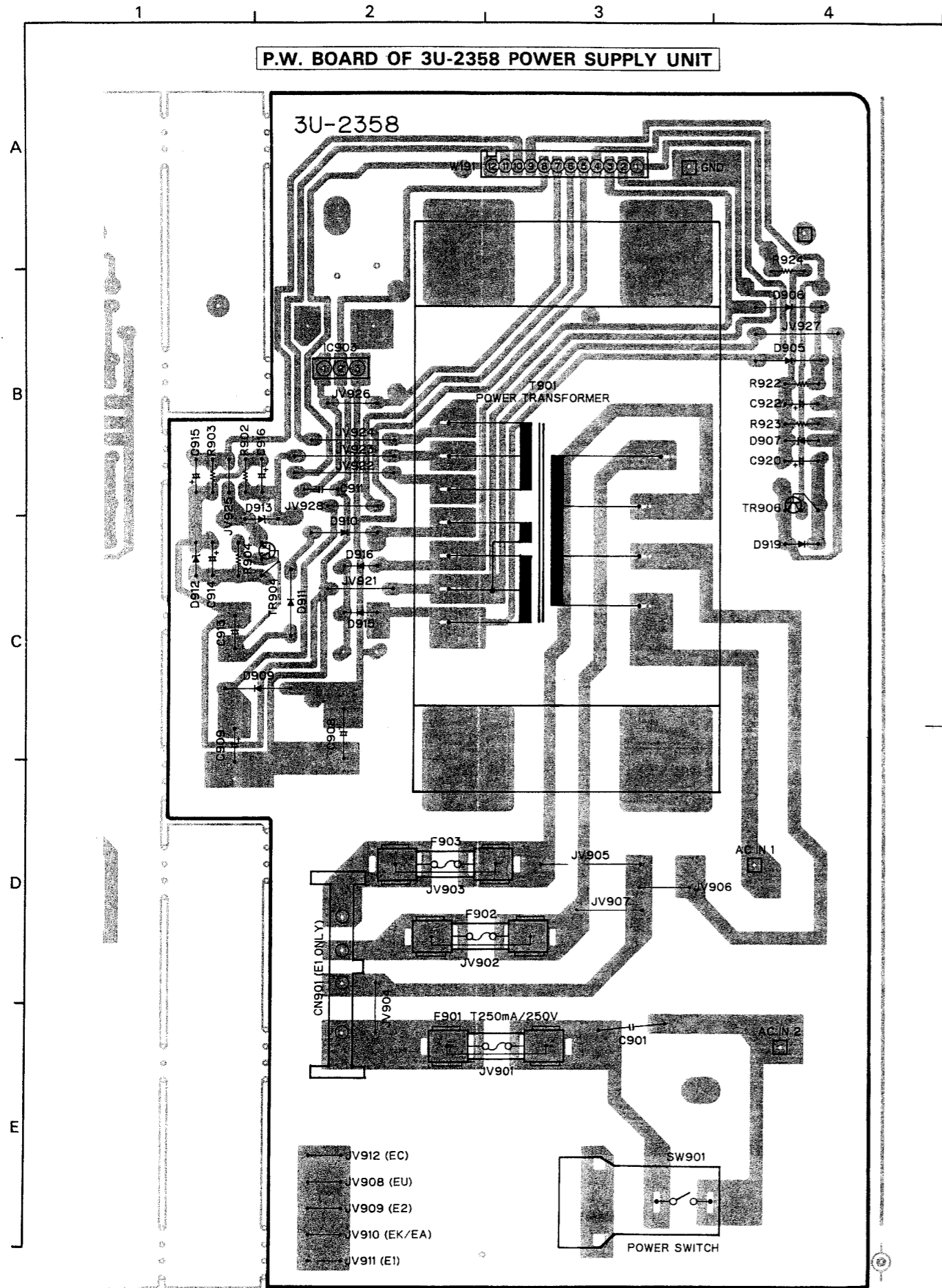

SEMICONDUCTORS

● IC

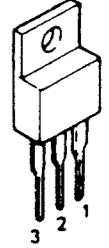
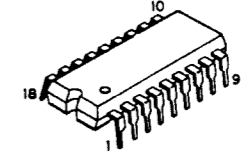
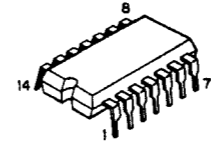
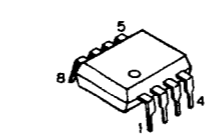

3 GND
2 INPUT
1 OUTPUT

● NJM7908

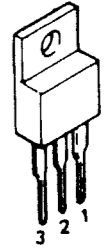

3 INPUT
2 GND
1 OUTPUT

● NJM7808
● NJM7806

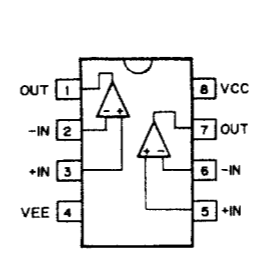

- M5218AP
- M5220P
- BA15218
- BA10393

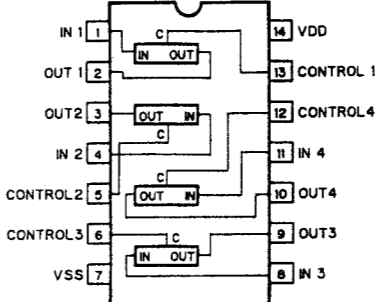

● HD14066BP

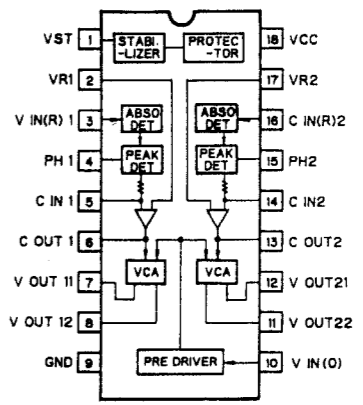

● μPC1297CA

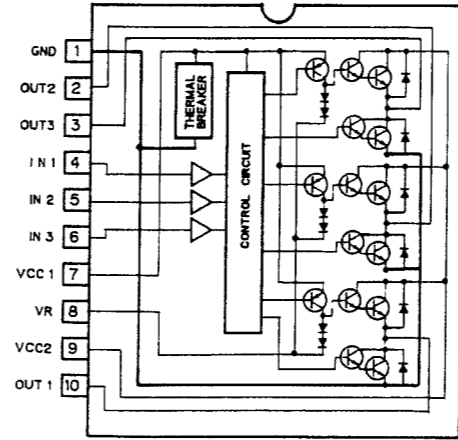
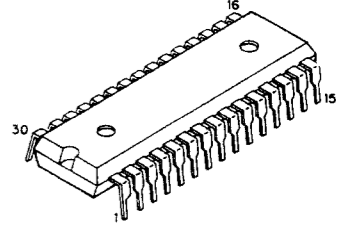
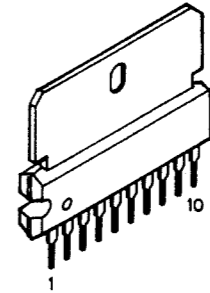
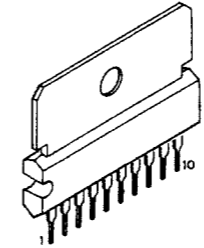

● BA6238A

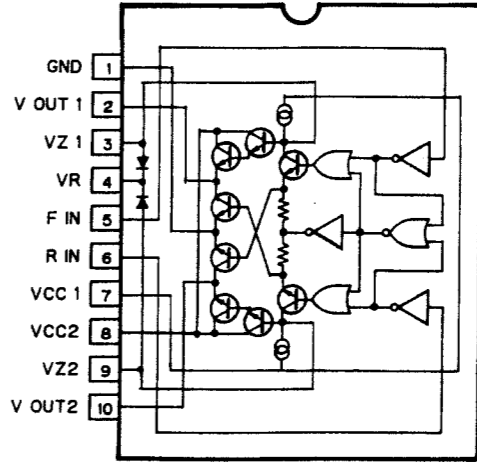

● BA6109

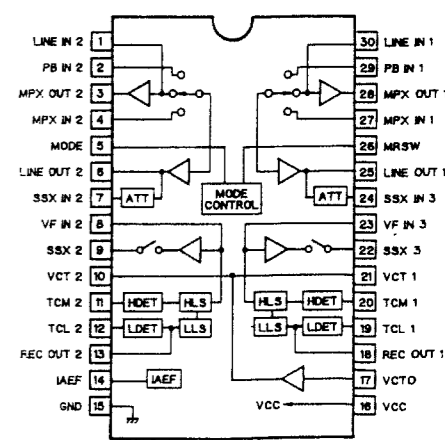

● CXA1330S

WIRING DIAGRAM

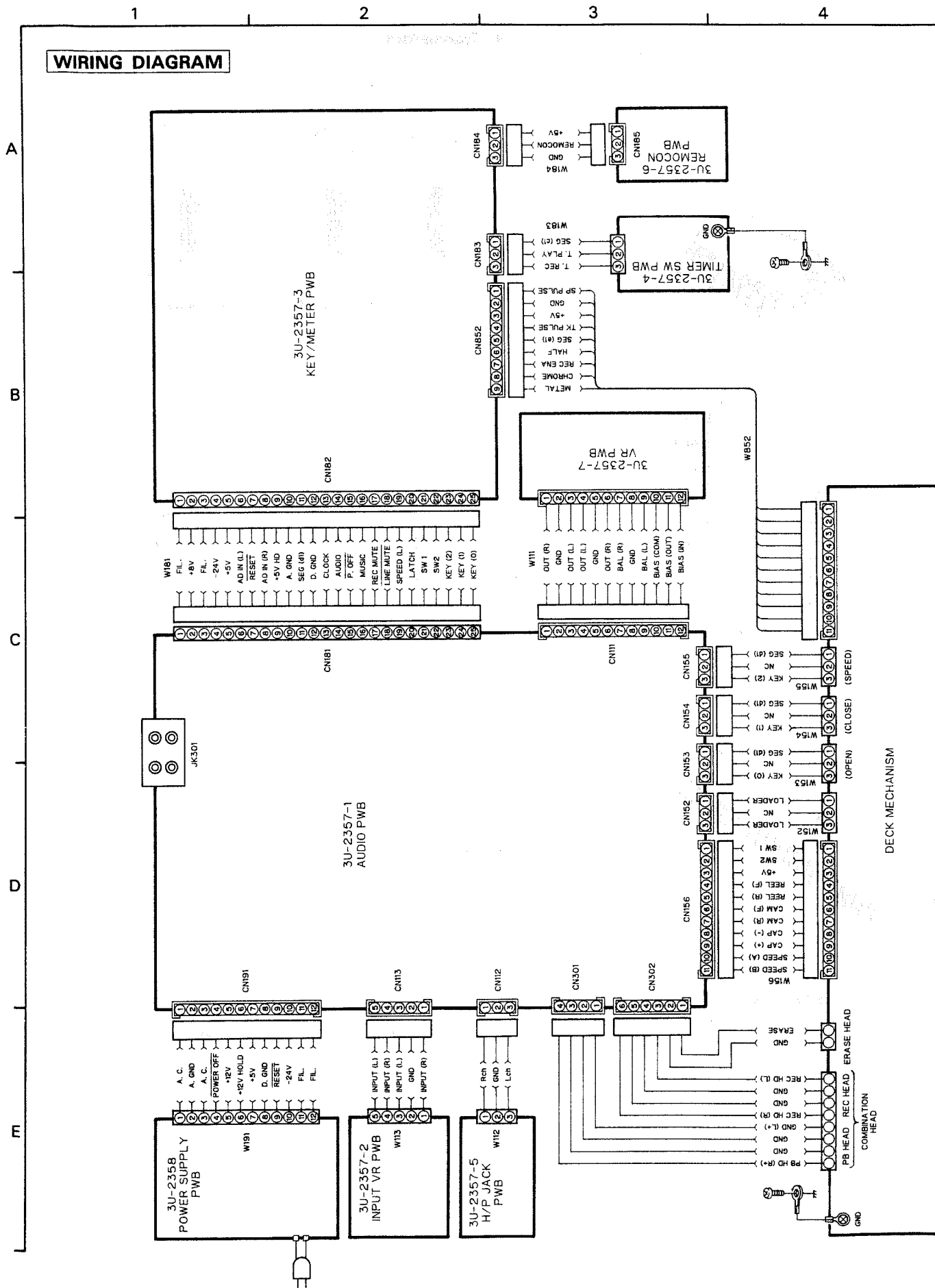

● Transistors

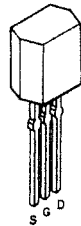
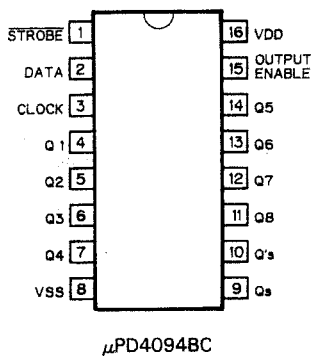
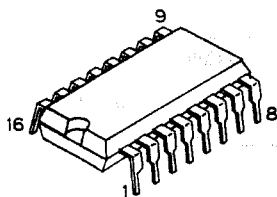

● 2SK381

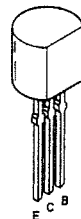

● 2SC2603

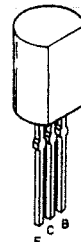

● 2SB562

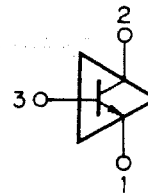
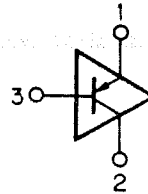

- DTA143ES
- DTA144WS
- DTA143XS

- DTC124ES
- DTC124XS
- DTC143TS
- DTC143ES
- DTC144ES
- DTC143XS
- DTC144WS

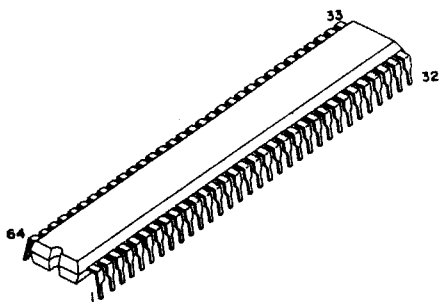

● UPD75268CW-040

● Diodes



- ISS270A
- ISR35-200A
- IS2076A

- HZS4C-1
- HZS3C-1
- HZS2C-1
- HZS6C-2
- HZS7B-3

- HZS9A-2
- HZS9B-2
- HZS27-3
- HZS11C-2

SCHEMATIC DIAGRAM

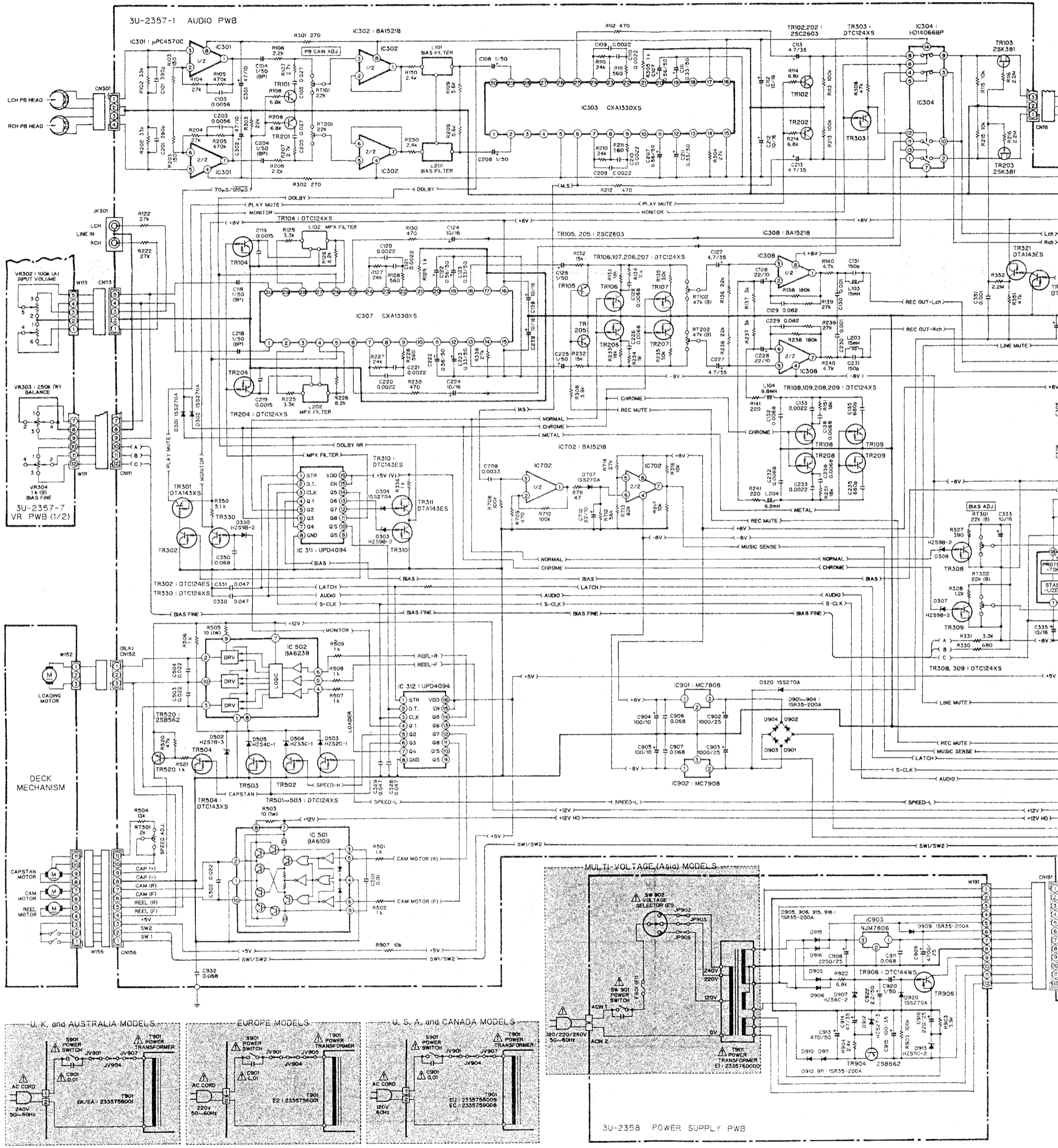

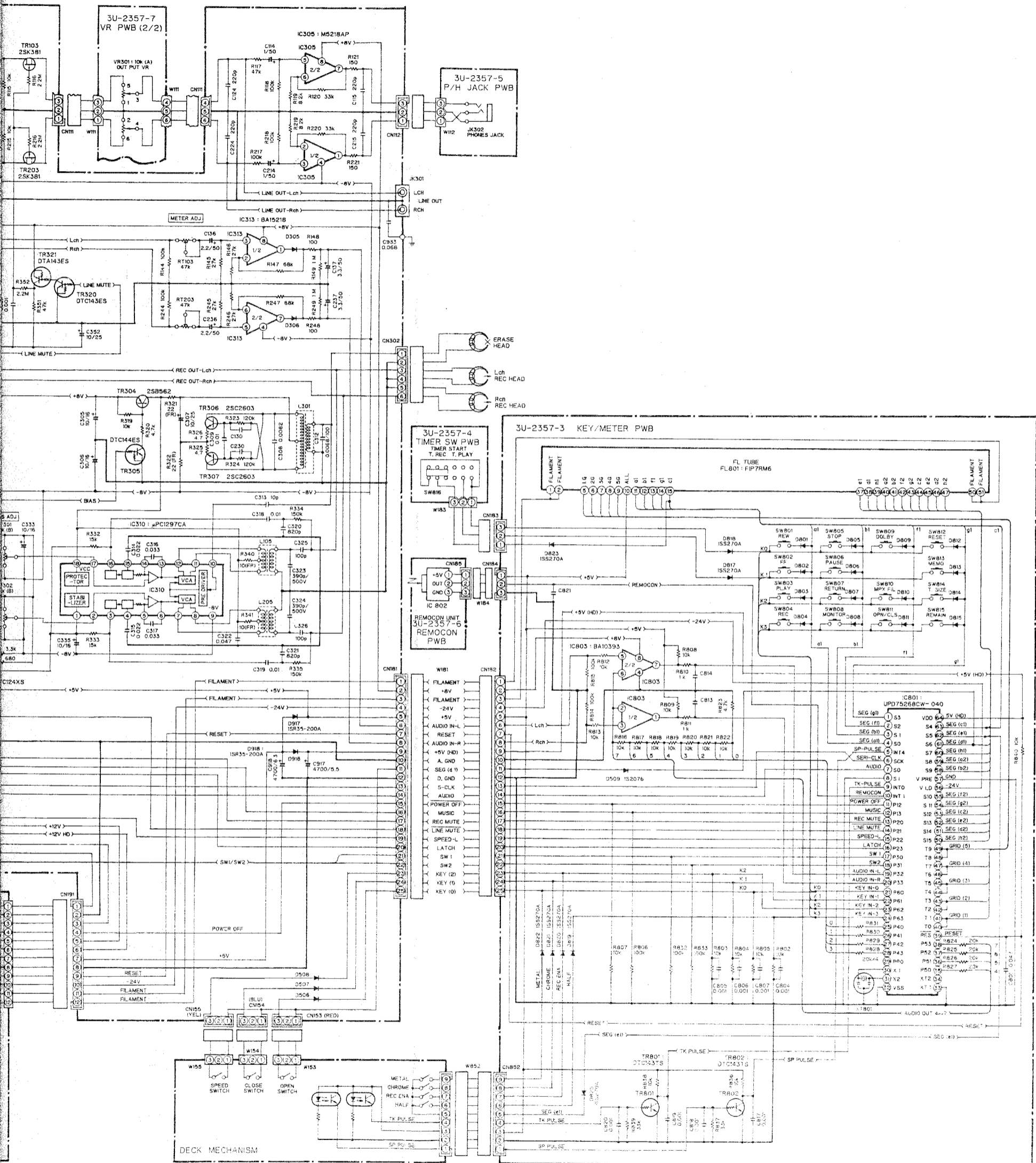

Note:

- Resistance shall be 1/4 W unless otherwise specified and the Units: ohm
- The unit of capacitor is μF , P is pF unless otherwise specified.
- This circuit diagram shows the basic circuit. It is subject to change for the purpose of improvement.

Parts marked with this symbol \triangle have critical characteristics. Use ONLY replacement parts recommended by the manufacturer.

1

2

3

4

5

BUNDLE DIAGRAM

A

B

C

D

E

F

G

H

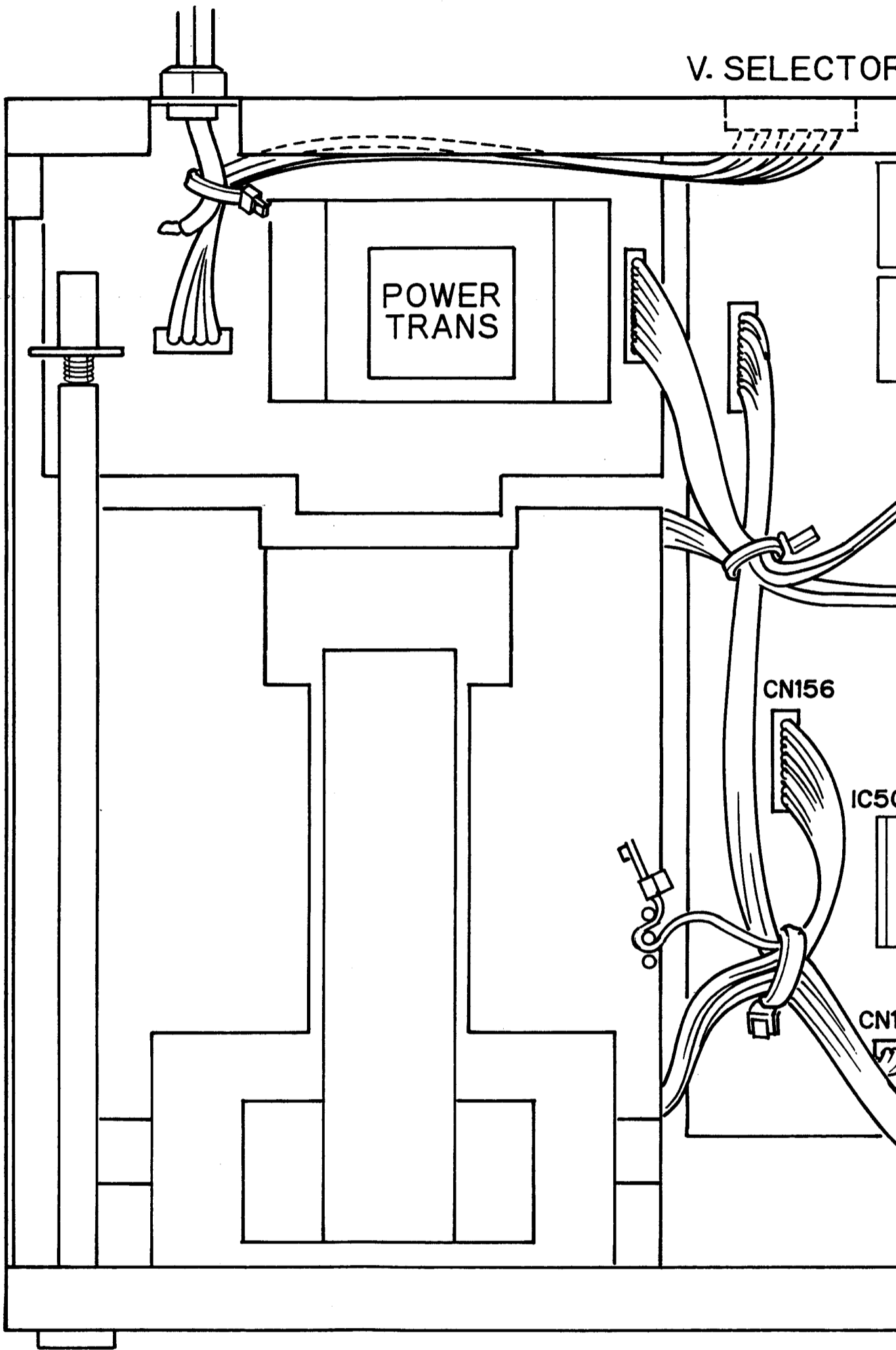

TOR (Multiple Voltage Models Only)

