

C 115

Professional
Cassette Tape Deck

REVOX®



2. ASSEMBLY / DISASSEMBLY

2.1 General informations

Caution: Disconnect the tape recorder from the AC power source before you remove any housing parts or electronic modules!



Important: Handling of MOS components:



MOS components can be destroyed by electrostatic discharges. When working on equipment containing MOS components, the following precautions should be observed:

1. Electrostatically sensitive components must be stored and transported in the corresponding protective packing.
2. Avoid any contact of the pins with plastic packing material, styrofoam or other chargeable materials.
3. Do not touch the pins with an ungrounded wrist.
4. Use a grounded, conductive pad as a work surface.
5. Do not unplug or insert circuit boards while the cassette recorder is under voltage.

2.1.1 Maintenance

All bearings are lubricated for life and require no maintenance.

2.1.2 Required tools

1 Screwdriver	Size 1
1 Phillips screwdriver	Size 1
1 Phillips screwdriver	Size 2
1 "ESE" workplace kit	Part No. 46200

Note: Line the bench with a piece of cotton cloth or similar to prevent marring of the housing surfaces.

2.1.3 Reassembly

The unit is reassembled analogously by performing the disassembly steps in the reverse order and by following the explicit assembly instructions.

2.2 Disassembly

2.2.1 Housing

1. Unfasten two screws (1) on the side panel and three screws (2) on the back.
Lift the cover and pull it off toward the back.

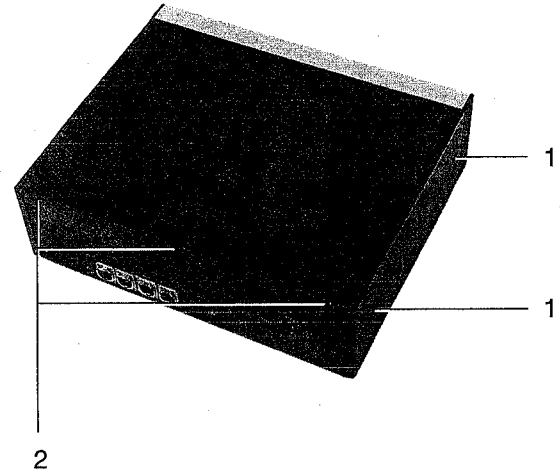

2.2.2 Front Unit

1. For removing the front unit, the following connectors must be detached:

- J 6 on the power supply unit
- J 2 on the power supply unit
- MP 7 on the cassette deck
- WU 01 on the cassette deck
- JJ 31 on the audio board
- JK 31 on the audio board
- JU 34 on the audio board
- Ground screw on the audio board

2. Unfasten three screws (1) on the front trim strip and remove the strip.
3. Unfasten four screws (2) on the front unit.
4. Pull the front unit evenly upward (approx. ½ cm / ¼") until it disengages from the lower retainer.
5. Carefully move the front unit toward the front and set it on a piece of cotton cloth.

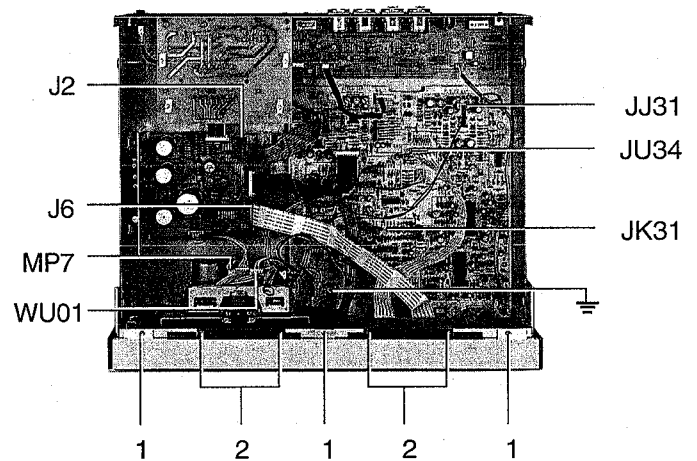

2.2.3 Cassette deck assembly

1. Detach the connector MP 5 to the front unit.
2. Press the cassette eject button and lift off the cassette deck trim strip.
3. Unfasten the two screws (1) from the lever mechanism and remove the latter.
4. Unfasten the four screws (2) of the two mounting flanges (do not lose the washers).
5. The cassette deck and the cassette compartment can now be removed as a complete unit.
6. To detach the cassette compartment from the deck, unfasten the four screws (3), remove the mounting flanges, and carefully lift out the cassette deck.
7. By reassembling, make shure that the cassette compartment fits symmetrically the front pannel opening.

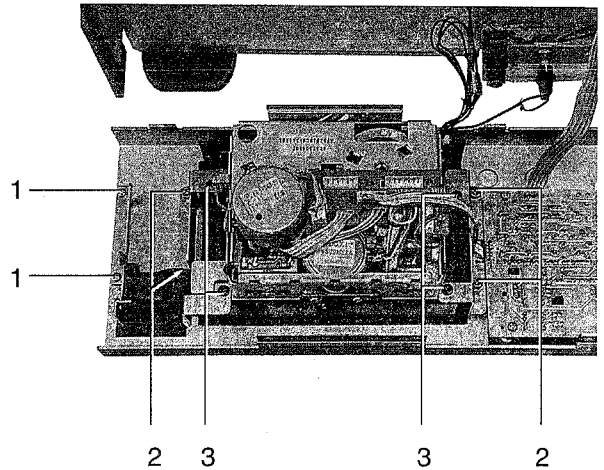

2.3 Cassette deck mechanism

2.3.1 Tape guide rollers

- 1 Fixing and adjusting nut of the left-hand tape guide roller
- 2 Fixing screw of the right-hand tape guide roller
- 3 Fixing and adjusting screw of the right-hand tape guide roller

2.3.2 Soundheads

- 4 Two fixing screws of the record/reproduce head and the swivel plate.
- 5 Three adjusting screws for REC/PB head height and parallel alignment
- 6 Azimuth adjustment screw
- 7 Fixing screw for the erase head

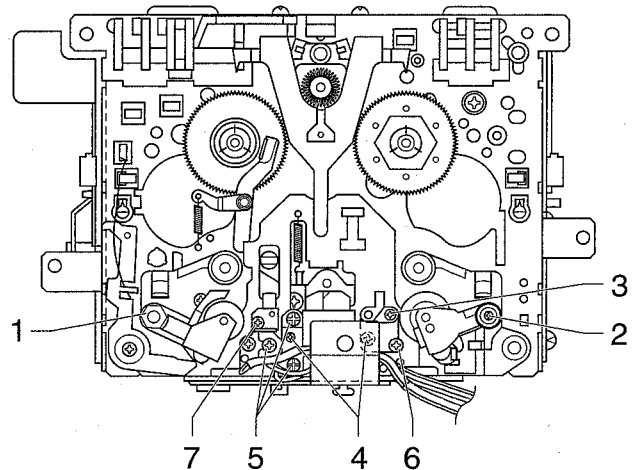

2.4 Electronic modules

For replacing electronic modules, open the recorder as described in Section 2.2.1.

For removing the front unit, proceed according to Section 2.2.2.

2.4.1 Mains Unit

Caution: Pull out the AC power plug before you remove the mains unit.

1. Detach connector J 4 (1) on the power supply unit.
2. Remove the acrylic glass cover by pressing the clamping pins together.
3. Detach the ground connection (2) on the side panel and the two connectors (3) on the power switch.
4. Unfasten three screws on the back of the chassis, unfasten the two (4) of the power transformer and remove the mains unit.

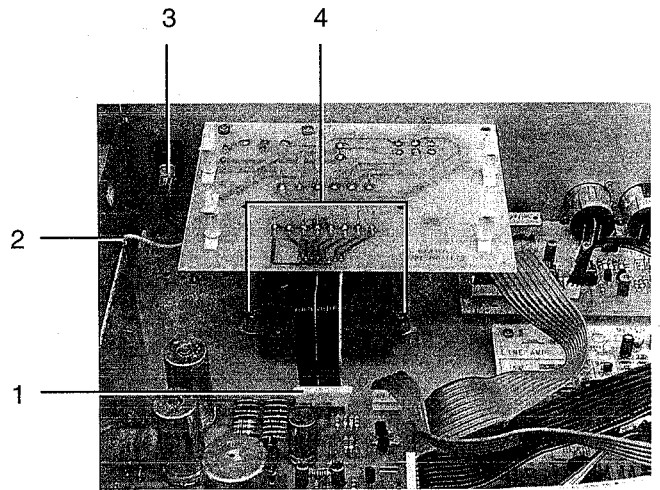

1.4.2 Power supply Unit

1. Detach the following connectors:
 - J 1 of the mains unit
 - J 3 of the audio board
 - J 4 of the front unit
 - J 2 of the front unit
 - J 1 / J 2 of the IN/OUT unit
 - MP 7 on the cassette deck
2. Unfasten four screws (1) and remove the circuit board.

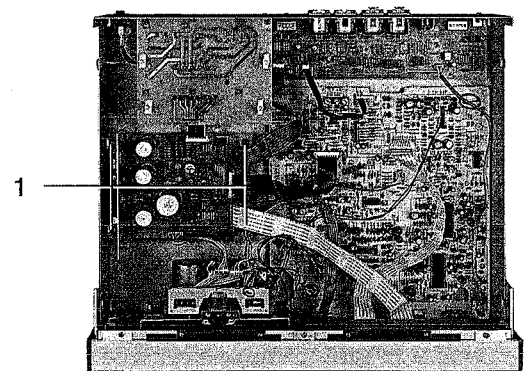

2.4.3 IN / OUT Unit

1. Unsolder the connections of J 1 and J 2 on the circuit board. Unsolder the cable WW 01 (note the polarity).
2. Unfasten the two screws (1) on the back of the chassis.
3. Insert a screwdriver size 00 through the center hole of the input / output sockets (2) on the back of the chassis and turn the catch counterclockwise by 45°.
4. Lightly lift the IN/Out board and pull it forward by a short distance. Then release the catches at the inserts of the input connectors and remove the board completely.

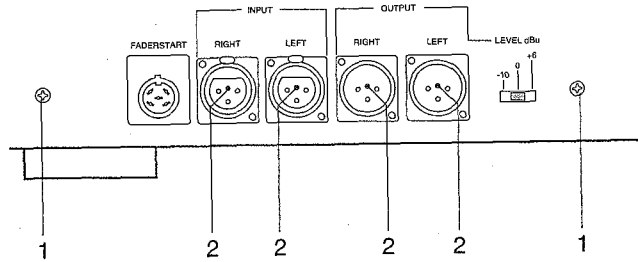

2.4.4 Audio board

1. Detach the following connectors:
 - J 2 of the IN/OUT unit
 - WW 01 of the IN/OUT unit (unsolder)
 - JU 34 of the front unit
 - JJ 31, WU 01, JK 31 and GROUND of the cassette deck
 - J 832 of the power supply unit
2. Unfasten four screws (3) and slide out the board toward the back.

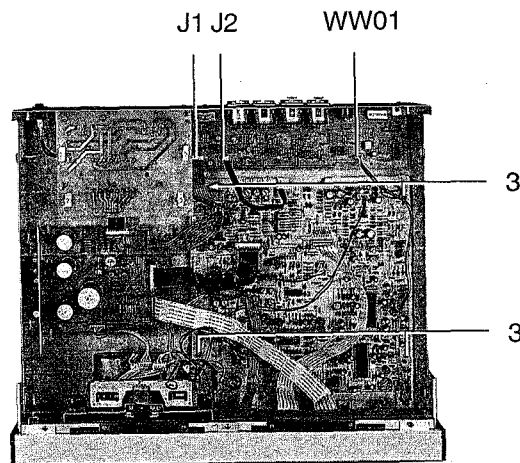

2.4.5 Front Unit

1. Detach the MP 5 (1) cable on the cassette deck.
2. Unfasten seven screws (2) on the front unit (do not lose the washers), and carefully remove the board. Make sure that the red display trim strip does not get scratched.

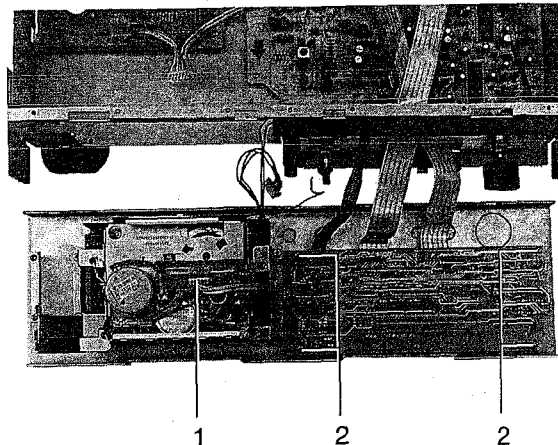

3. FUNCTIONAL DESCRIPTION

3.1 Cassette deck

The cassette deck is equipped with a dual capstan drive. The controlled DC motor drives the righthand capstan shaft via a flat belt. From this shaft the left-hand capstan is driven by a second flat belt.

The capstan drive control is integrated in the motor housing. The capstan speed can be adjusted with a trimmer (-> 4.2.3).

The headblock assembly is actuated by the capstan motor via a cam disc. Coupling/decoupling is performed by a small solenoid.

The brakes are also controlled via a cam disc.

The spooling motor drives the spindles via a gear train. The left-hand or right-hand spindle is driven, depending on the selected spooling direction. Each spindle has its own light barrier that supplies the tape timer information to the microprocessor.

3.2 Control

POWER SUPPLY:

The power supply Unit contains the power supply and the spooling motor drive.

The power supply generates the following voltages:

- +/-12 V DC for audio, stabilized with rectifier (D 4 - 11) and voltage regulator (IC 1 and 2)
- +14 V DC unstabilized from the rectifier (D 12 - 19), for the capstan motor, the spooling motor and the solenoid.
- +5 V DC from the +14 V, stabilized by IC 3, for the processor control.
- 4,3 V AC (FIL) for the heating coil of the display
- -30 V DC from D 20 for the display.

If the 5 V supply drops below a certain value when the cassette recorder is switched off or in the event of a power failure, a reset is generated by the regulator IC 3.

IC 4 contains the drivers for the spooling motor. Depending on the cassette deck status, a corresponding voltage is applied to the spooling motor.

FRONT UNIT:

The front unit contains the input keypad as well as the microprocessor. The latter is responsible for scanning the keyboard, for controlling the display, and for calculating the tape timer and peak meter information.

A special feature of this processor are the high-voltage outputs through which the FIP can be controlled directly. The internal A/D converter is used for peak level measurement and for keyboard scanning.

3.3 Audio electronics

AUDIO BOARD

The complete audio electronics is located on the audio board.

Recording section:

The input signal is taken via the volume control RV 01 to the Dolby B/C encoder Q 651. The multiplex filter is connected after the first linear stage and switched on or off by means of the transistors Q 653 and Q 654. After a second stage within Q 651, the audio signal is taken to the monitor switch QT 51 (changeover between source and tape). The coded record signal is available on pins 21 and 22 of Q 651 and is taken via internal and external calibration potentiometers to the record amplifier QK 01. The latter is equipped with internal equalization selection switches. After the RF bias trap the RF is added to the AF signal via the transformers L 901 and L 902. The HX PRO circuit is implemented with IC Q 901 which contains the rectifier, the integral controller and the VCA. IC Q 921 is used for switching the HX PRO circuit on / off which in this recorder is continually on. This means that the HX PRO circuit always receives the signal after the two lowpass elements R 906 / C 902 and R 905 / 901. The erase oscillator is implemented as a push-pull stage and oscillates with a frequency of 105 kHz. It supplies the RF signal to the HX PRO circuit.

Reproduce section:

The reproduce signal is amplified in IC QJ 31 which features a low-noise FET input stage. The reproduce time constants are implemented in a push-pull stage and can be changed over between 70 and 120 μ s (QJ 05 / 06). The output signal is taken to the level and treble control as well as to the Dolby B/C Decoder chip Q 601. The aggregate signal of the right-hand and left-hand channel is taken to the pause detection circuit implemented with QB 01. The output of the Dolby detector is taken to the monitor switch and to the peak meter amplifier QX 01, to the headphones volume control comprising the amplifier stage QG 01, and to the buffer amplifier IC 1 / IC 2 (on the IN/OUT unit).

The output level switch which controls Q 1...Q 4 has three positions:

- 10 dBu
- 0 dBu
- + 6 dBu

The audio signal is subsequently taken to the balancing amplifier IC 3, IC 4 and finally to the XLR sockets output left/right.

4. ALIGNMENT INSTRUCTIONS

Caution: If the demagnetizing choke comes close to recorded cassettes, the audio signals on the cassettes will be destroyed.

4.1 General information

Caution: Shock hazard when the tape recorder is opened. Certain parts are energized with line voltage!

4.1.1 Tools

The following equipment and tools are required for the alignment work:

AF millivoltmeter	Part No. 46020
AF Generator	Part No. 46021
Demagnetizing choke:	
- Large	Part No. 46595
- Small	Part No. 46596
Reproduce reference tape	Part No. 46034
Frequency counter	Part No. 46025
2-beam oscilloscope	
Analog multimeter	
Selective voltmeter or	
Bandpass (fm =1kHz; BW ≤100 Hz)	
Tweezers	
Screwdriver	Size: 00
Screwdriver	Size: 0
Screwdriver	Size: 2
Screwdriver	Size: 3
Hexagon-socket-screw key	Size: 2.5
Tape path alignment gauge	Part No.: 46172
Head face alignment cassette	Part No.: 46040
Wow and flutter	
calibration cassette	Part. No.: 46037

4.1.2 Demagnetization

Before any alignment work and in intervals of every few weeks, the cassette recorder should be demagnetized. Switch the cassette recorder off, make sure that no cassette is in the compartment and that no cassettes are located in the vicinity of the recorder. Slowly approach but do not contact the part to be demagnetized with the tip of the choke and after a short moment slowly retract the choke; or with a regulating transformer slowly increase the choke voltage to maximum and back to minimum. This procedure is to be performed for all metal parts (sound heads, tape guides) that come in contact with the tape. Before you switch off the choke remove it at least 50 cm from the cassette recorder.

4.1.3 Level definitions

0 dBu	≙	0,775 V _{eff}
+ 6 dBu	≙	1,55 V _{eff}
-10 dBu	≙	0,254 V _{eff}
0 dBu	≙	0 dB level

4.2 Cassette deck alignments

The tape deck is factory aligned. If the complete cassette deck is replaced, only an electronic azimuth check needs to be performed.

If realignment is necessary for any reason, the cassette tape deck must be removed. A soundhead alignment gauge (1) Part No. 46172 is required.

To remove the cassette tape deck proceed according to 2.2 / 2.3.

4.2.1 Record / reproduce head

1. Check the height and parallel alignment of the soundheads with the aid of the vernier calipers (2).
2. Adjust the height and the parallel alignment with the three adjustment screws (3).
3. Correct the azimuth with the adjustment screw (4).
4. Before reinstallation, carefully clean all cassette deck components and demagnetize the soundheads. (→ 4.1.2).
5. For fine-adjustment install the cassette deck, remove the cassette deck trim strip, and play the reference cassette (Part No. 46034).
6. Align for minimum phase error with the azimuth adjustment screw (4), using the 10 kHz signal.

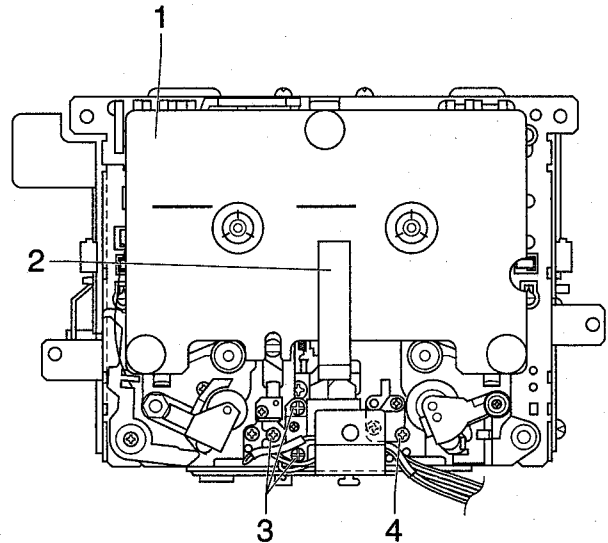

4.2.2 Tape guidance

1. Check the height of the left-hand tape roller (2) with the aid of the vernier calipers (1).
2. If necessary, correct the setting with the adjustment nut (3).
3. Check the height of the right-hand guide (5) with the aid of the vernier calipers (1).
4. If necessary, correct the setting with the adjustment screw (4).

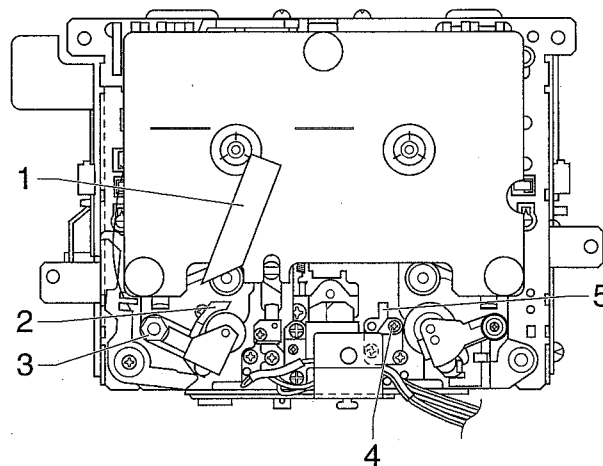

4.2.3 Adjusting the capstan speed

The capstan speed can be adjusted while the cassette deck is installed.

1. Insert and play the alignment cassette.
2. To adjust the speed, insert the screwdriver size 00 through the opening at the back of the motor housing (1) and turn the adjustment element. The speed should be adjusted within a tolerance of $\pm 0.2\%$.

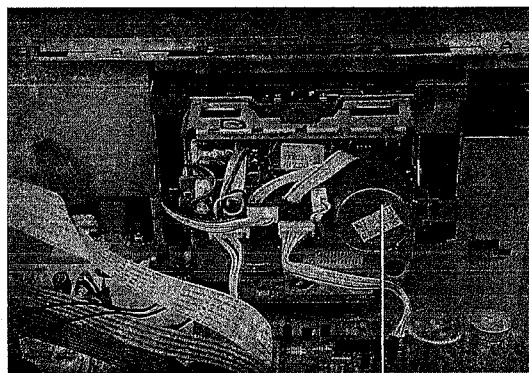

1

4.3 Audio alignments

All adjustment controls for this work are located on the audio board.

4.3.1 Peak meter

- Connect the AF generator to the AUDIO IN sockets.
- Connect the AF millivoltmeter to the AUDIO OUT sockets L, R.
- Set the OUTPUT LEVEL switch to the 0 dBu position.
- Press the REC key to switch to SOURCE (Rec/ Pause).
- From the generator feed a 1 kHz sine-wave signal so that a level of 775mV appears on the output.
- With the trimmer RX 01 (left) and RX 02 (right) adjust to 0 dB.
- Lower the input level by 35 dB and adjust the trimmer RX 31 in such a way that only the first segment lights up on the peak meter.

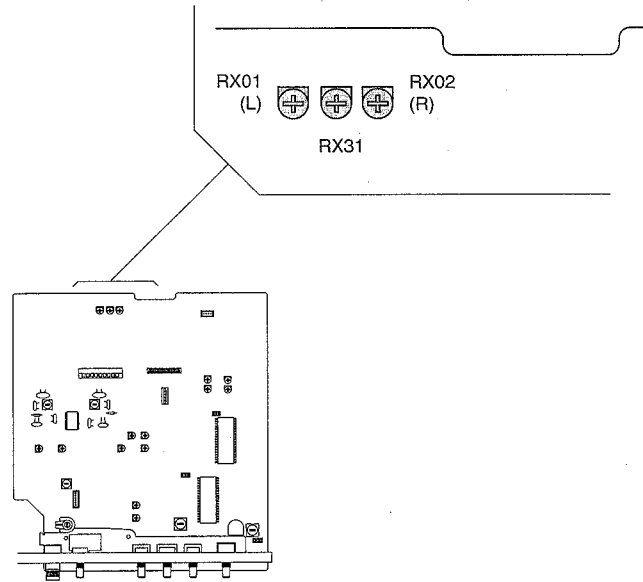

4.3.2 Frequency response with tape, MPX filter

- Frequency response check (level 0 dB display, freq. 30 Hz - 18 kHz +/- 1 dB)
- Feed 19 kHz 0 level 0 dB display to the INPUT sockets.
- Switch the recorder to REC/Pause by pressing the REC key.
- Switch on the MPX filter.
- Adjust the coils L 651 and L 652 to minimum level. The level should be attenuated by at least 30 dB.

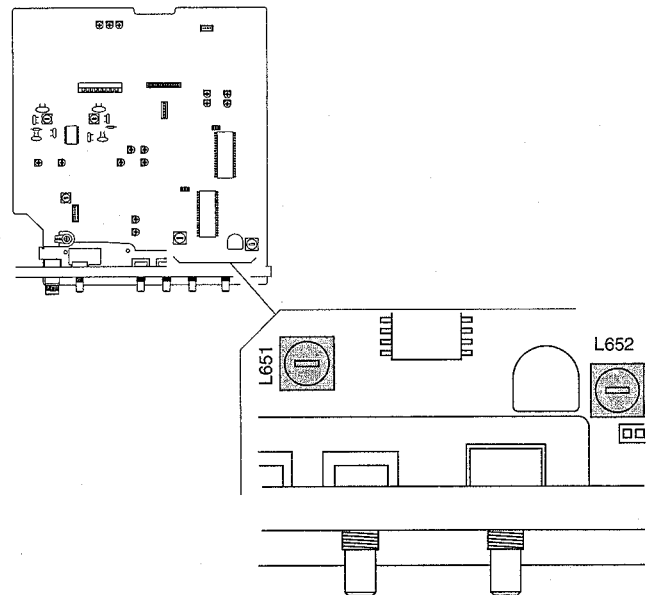

4.3.3 Aligning the erase frequency

- Switch on the cassette recorder and activate the record mode.
- Connect the frequency counter to pin 6 of the edge connector JK 31.
- Adjust the frequency to 105 kHz by aligning the core of transformer LL 01.

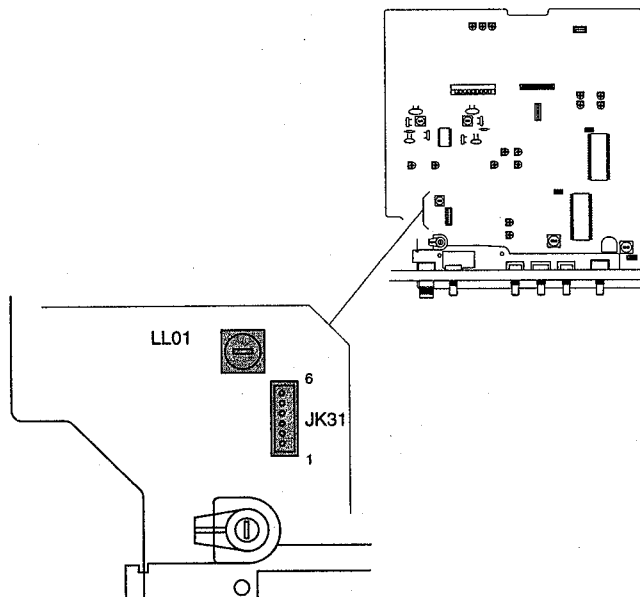

4.3.4 Aligning the erase and record head

- Switch on the cassette recorder and activate play mode.
- Connect the oscilloscope with 10:1 probe to the intersection C 909 / 913.
- By tuning the core of transformer L901 align the resonant circuit of the left-hand channel to a clean sinusoidal shape.
- Connect the oscilloscope probe to the intersection C910 / 914.
- By tuning the core of the transformer L 902, align the sine-wave shape of the right-hand channel.

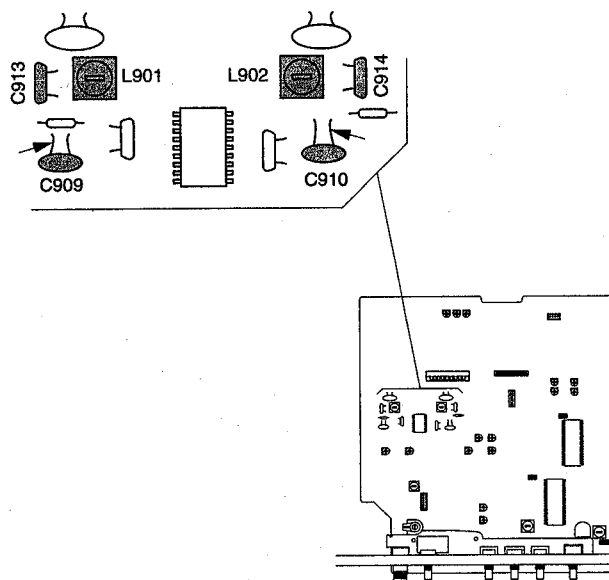

Note: For the RF measurements described in Sections 4.3.3 and 4.3.4, the test points should be loaded with max. 20 pF, otherwise the adjustment will not be optimal.

4.3.5 Playback

- Switch the cassette recorder off, thoroughly clean the tape guidance elements, and demagnetize the heads. (-> 4.1.2).
- Set the output level switch on the rear panel to "0 dBu".
- Insert the reproduce frequency response calibration cassette.
- Spool the reference tape forward to the 10 kHz section and start the recorder in play mode.
- Connect the LINE OUTPUT L and R to CH 1 and 2 of the oscilloscope and align the reproduce head to identical phase position of the channels.
- In the 315 Hz level tone section of the tape, align the reproduce level of the corresponding channel with the aid of the trimmers RJ 29 and RJ 30.
- The output level at "0 dBu" corresponds to 775 mV with a magnetic flux of 200 nWb/m, or 969 mV for a flux of 250 nWb/m.
- With the trimmer RJ 31 (left) and RJ 32 (right) align to a linear reproduce frequency response (0...+1 dB) at a frequency of 12.5 kHz.

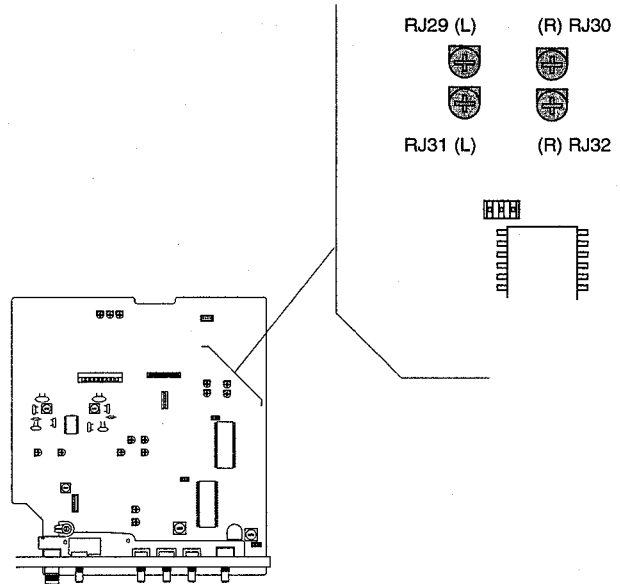

4.3.6 BIAS and REC LEVEL alignment

- Turn the front-panel Bias-Cal and Level-Cal potentiometers to their center positions.
- Open the level trimmer potentiometers RK 01 and RK 02 to approx. 2/3 of the maximum.
- Insert the IEC I cassette.
- Start the machine in record mode.
- Switch between 500 Hz and 12 kHz -20 dBu at the inputs.
- With the bias potentiometer align to a linear frequency response. (The correct value is determined by opening the potentiometer at 12 kHz from the counterclockwise stop position past the level maximum until the same value is measured as for 500 Hz.
- Feed 500 Hz and adjust the level with the trimmers RK 01 and RK 02 in such a way that the levels for source and tape are identical.
- For chromium dioxide tape and metal tape, align the bias in such a way that a linear frequency response is achieved. Only one bias setting is possible for both channels. R 933 for chromium dioxide and R 934 for metal tape. If bias corrections are required in the level or between the channels, these should be very small because they also influence the IEC I settings.

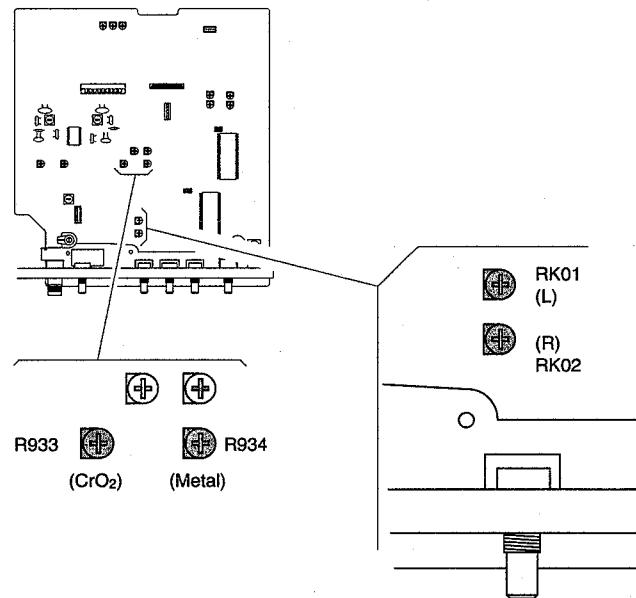

Note: It is important to start the alignment with the IEC I tape in order not to influence the adjustments of the other tape types.

4.4 Measurement of various ratings

4.4.1 Distortion with tape

The distortion of cassette recorders is measured with a K3-filter (bandpass for 3rd harmonic). The AF generator frequency must be selected in accordance with the existing filter (e.g. 333 Hz for a filter frequency of 1000 Hz). The measurement relates to maximum output level.

- Connect the AF generator to the AUDIO IN socket.
- Set the frequency.
- Connect the distortion meter to AUDIO OUT.
- Insert a new tape. Start the cassette deck in record mode and measure the distortion. The maximum values can be found in the technical data (-> 5).

4.4.2 Signal-to-noise ratio with tape

- The signal to noise ratios (linear and weighted) relate to 3% distortion.
- The measured values are specified in the technical data (-> 5).

4.4.3 Erase depth

For measuring the erase depth, a signal is recorded and erased. The residual signal on the tape is measured selectively (narrow-band).

- Preselect an AF generator frequency of 1 kHz
- Connect a selective voltmeter (with 1 kHz bandpass) to OUTPUT.
- Record the signal with a level of 250 nWb/m
- Switch the generator off.
- Rewind the tape and start again in record mode.
- Measured value: better than -65 dB for type II.

4.4.4 Crosstalk

- Measuring signal: 1 kHz / 0 dB.
- The measured value on the channel without signal should be better than -40 dB.

4.4.5 Wow and flutter

- The wow-and-flutter values given in the specifications have been measured with a wow-and-flutter meter according to JIS in Playback mode.

5. TECHNICAL DATA

Tape cassettes:	Compact cassettes up to C-120	Bias / Erase frequency:	105 kHz
Tape deck:	Dual capstan tape transport with controlled spooling drive. Separate head system for record and playback, ferrite erase head	Erase efficiency:	> 65 dB @ 1 kHz (DOLBY C = ON)
Tape speed / tolerance:	1 7/8 ips \pm 0.5 %	Input AUDIO IN	
Tape slip:	< 0.3 %	Sensitivity:	70 mV for 200 nWb/m
Wow and flutter:	< 0,1 % for C-60 and C-90 cassettes, in playback mode (weighed according to JIS)	Input impedance:	> 10 kohms
Spooling time:	95 s for C-60 cassette	Max. input level:	10 V
Tape timer:	switchable between: • min / sec (elapsed real time) • linear counter, 4 digits	Outputs:	
Automatic tape type changeover:	For tape types I, II and IV	AUDIO OUT:	Values rel. to 200 nWb/m -10 / 0 / +6 dBm, Ri = 50 ohms
Recording system:	HX PRO * Headroom Extension	PHONES:	max. 500 mV, Ri = 100 ohms
Calibration aid:	With BIAS and LEVEL potentiometers via bargraph display	Special function:	Faderstart, to be activated via 6-pole socket DIN 45322
Noise reduction system:	DOLBY B and C *, Double-Dolby system for source / tape monitoring	Power requirements:	Selectable for 2 ranges: 115 V, range = 90 to 130 V 230 V, range = 190 to 260 V 50...60 Hz
Reproduce equalization:	Type I: 3180 + 120 μ s Type II: 3180 + 70 μ s Type IV: 3180 + 70 μ s	Power consumption:	30 W
Frequency response:	(with tape, -20 dB, Dolby NR = OFF) Type I: 30Hz...18 kHz \pm 3dB Type II: 30Hz...17 kHz \pm 3dB Type IV: 30Hz...17 kHz \pm 3dB	Power fuse, primary:	for 115 V: T315 mA slow-blow for 230 V: T315 mA slow-blow
Level Calibration:	200 nWb/m, corresponds to 0 dB = DOLBY level	Environmental operating conditions:	Ambient temperature +10 to +40°C Rel. humidity category F according to DIN 40040
Harmonic distortion:	at 200 nWb/m (k3 of 333 Hz) Type I: <1.0 % Type II: <1.5 % Type IV: <1.5 %	Operating position:	Horizontal installation
Signal-to-noise ratio ref. to weighted 3% distortion:	Dolby C Type I: > 72 dB (A) Type II: > 73 dB (A) Type IV: > 73 dB (A)	Weight:	7.5 kg net
Channel separation:	better than -40 dB @ 1 kHz	External dimensions:	(WxHxD) w/o rack-mounting brackets 470 x 143 x 366 mm (height = 3 rack units)
		Subject to change	

The tape-specific specifications are achieved with modern high-quality cassettes. Values measured with:

- Type I (Ferro): TDK AR-X
- Type II (chromium): BASF Chrome Super II
- Type IV (metal): TDK MA

* Dolby noise reduction and HX PRO headroom extension manufactured under license from Dolby Laboratories Licensing Corporation. HX PRO was created by Bang & Olufsen. DOLBY, the double D symbol, and HX PRO are registered trademarks of Dolby Laboratories Licensing Corporation.

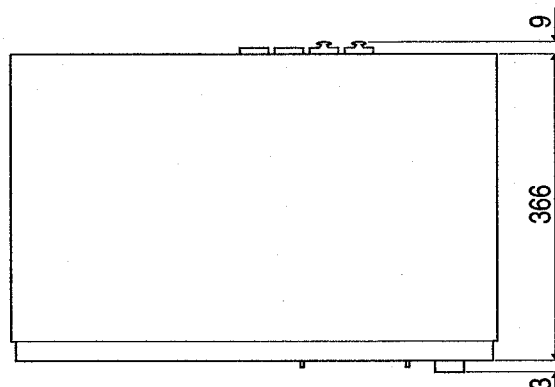
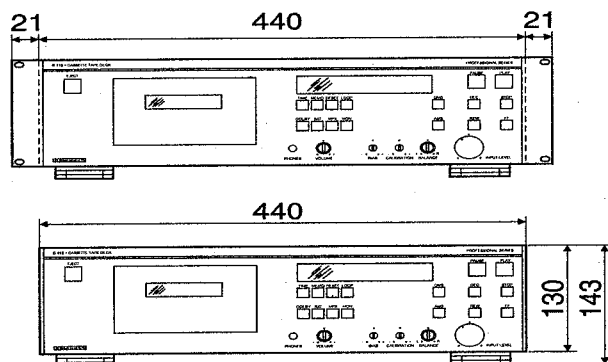

20.21.7102 < SHEET METAL SCREW D.2.2 X4.5 BLECHSCHRAUBE D.2.2 X4.5 VIS A TOLE D.2.2 X4.5	50.09.0106 < IC NE-5532A = RC-5532ANB CI NE-5532A = RC-5532ANB
20.23.7355 < SELF TAPPING SCREW D.3 X8 KERBSCHRAUBE D.3 X8 VIS AUTO-TARAUEUSE D.3 X8	50.10.0104 < IC LM-317 CI LM-317
20.25.0103 < SELF TAPPING SCREW D.2.2 X6.5 KERBSCHRAUBE D.2.2 X6.5 VIS AUTO-TARAUEUSE D.2.2 X6.5	50.10.0105 < IC LM-337 CI LM-337
21.26.0354 < PHILLIPS HEAD SCREW M3 X6 ZYLINDERSCHRAUBE KS M3 X6 VIS CYLINDRIQUE CRUCIF.M3 X6	50.17.1132 < IC MC-74HC132AN CI MC-74HC132AN
21.26.0455 < PHILLIPS HEAD SCREW M4 X8 ZYLINDERSCHRAUBE KS M4 X8 VIS CYLINDRIQUE CRUCIF.M4 X8	50.43.0350 E 50.03.0350
21.46.0354 < TORX HEAD SCREW M3 X6 ZYLINDERSCHRAUBE TORX M3 X6 VIS CYLINDRIQUE TORX M3 X6	50.43.0351 E 50.03.0351
21.46.0454 < TORX HEAD SCREW M4 X6 ZYLINDERSCHRAUBE TORX M4 X6 VIS CYLINDRIQUE TORX M4 X6	50.43.0436 E 50.03.0524
21.47.0354 < TORX HEAD SCREW M3 X6 BLK ZYL.SCHRAUBE TORX M3 X6 BLK VIS CYLIND. TORX M3 X6 BLK	50.43.0515 E 50.03.0496
24.16.2030 < STAR WASHER FAECHERSCHEIBE RONDELLE GROWER	50.99.0126 < OPTO-COUPLER 4N-28 = 4N-26 OPTO-KOPPLER 4N-28 = 4N-26 OPTO-COUPLEUR 4N-28 = 4N-26
50.03.0350 < TRANSISTOR J112 = MPF4392	51.01.0112 < FUSE 0.3A SICHERUNG 0.3A FUSIBLE 0.3A
50.03.0351 < TRANSISTOR 2N4403 = BC327-25	51.01.0114 < FUSE 0.5A SICHERUNG 0.5A FUSIBLE 0.5A
50.03.0496 < TRANSISTOR BC560 SEL. 100MA	53.03.0142 < FUSE HOLDER 1/2 PCB MOUNT. SICHERUNGSHALTER PRINTBEF. 1/2 PORTE FUSIBLE CIR.IMPR. 1/2
50.03.0504 < TRANSISTOR BD679=BDW63	53.03.0364 < IC SOCKET 64-P. IC SOCKEL 64-P. SOCKLE CI 64-P.
50.03.0524 < TRANSISTOR BC550 E6310 100MA	54.20.2001 < SOCKET DIN 6-P. PCB MOUNT. EINBAUBUCHSE 6-P. PRINTBEF. PRISE DIN 6-P. CIRCUIT IMPRIME
50.04.0105 DIODE 1N-4004 E 50.04.0502	54.21.1014 < PLUG DIN MAS-60 STECKER DIN MAS-60 FICHE DIN MAS-60
50.04.0125 < DIODE OF-159 = 1N-4448	54.21.2200 < CHASSIS PLUG XLR HOR. EINBAUSTECKER XLR WGR. FICHE CHASSIS XLR HOR.
50.04.0133 < DIODE BAW-20	54.21.2201 < CHASSIS SOCKET XLR HOR. EINBAUBUCHSE XLR WGR. PRISE CHASSIS XLR HOR.
50.04.0502 < DIODE 1N-4005	54.42.0020 < MAINS CONN. IEC-320 3-P.HOR. NETZANSCHLUSS IEC.320 3-P.WGR. PRISE SECTEUR IEC-320 3-P.HOR.
50.04.1103 < ZENER DIODE 7.5V DIODE ZENER 7.5V	54.99.0143 E 54.21.1014
50.04.1112 < ZENER DIODE 5.1V DIODE ZENER 5.1V	55.03.0287 < SWITCH POWER. NETZSCHALTER INTERRUPTEUR SECTEUR
50.04.1123 < ZENER DIODE 4.7V DIODE ZENER 4.7V	55.12.0003 < SLIDE SWITCH SCHIEBESCHALTER COMMUTATEUR A GLISSIERE
50.04.1145 < ZENER DIODE 9.1V DIODE ZENER 9.1V	55.17.1000 < SLIDE SWITCH 2X U SCHIEBESCHALTER 2X U INTERRUPTEUR A GLISSIERE 2X U
50.04.2701 < LED MV-57123 = SPR-5551REC RED	
50.04.2702 < LED MV-53123 = SPY-5551REC YEL	
50.04.2703 < LED MV-54123 GRN	
50.09.0105 E 50.09.0106	

55.99.0158 < PULSE SWITCH IMPULSSCHALTER INTER.IMPULSION		59.41.5470 E	59.22.6470
57.19.0100 < FUSE RESISTOR 10E SICHERUNGSWIDERSTAND 10E RESISTANCE FUSIBLE 10E		59.41.6100 E	59.22.8100
57.19.0109 < FUSE RESISTOR 1E SICHERUNGSWIDERSTAND 1E RESISTANCE FUSIBLE 1E		59.41.6220 E	59.22.6220
57.19.0151 < FUSE RESISTOR 150E SICHERUNGSWIDERSTAND 150E RESISTANCE FUSIBLE 150E		59.41.8229 E	59.22.8229
57.19.0560 < FUSE RESISTOR 56E SICHERUNGSWIDERSTAND 56E RESISTANCE FUSIFLE 56E		59.41.8479 E	59.22.8479
59.22.4221 < CAPACITOR EL. KONDENSATOR EL. CONDENSATEUR EL.	220UF 16V 220UF 16V 220UF 16V	62.02.3479 < RF CHOKE DROSSEL BOBINE DE CHOC	4.7UH 4.7UH 4.7UH
59.22.4471 < CAPACITOR EL. KONDENSATOR EL. CONDENSATEUR EL.	470UF 16V 470UF 16V 470UF 16V	62.42.3479 E	62.02.3479
59.22.4472 < CAPACITOR EL. KONDENSATOR EL. CONDENSATEUR EL.	4700UF 16V 4700UF 16V 4700UF 16V	1.010.011.55 < PUSHBUTTON 17 DRUCKTASTE 17 TOUCHE 17	
59.22.5101 < CAPACITOR EL. KONDENSATOR EL. CONDENSATEUR EL.	100UF 25V 100UF 25V 100UF 25V	1.010.012.55 < PUSHBUTTON 10 BLK DRUCKTASTE 10 BLK TOUCHE 10 BLK	
59.22.5222 < CAPACITOR EL. KONDENSATOR EL. CONDENSATEUR EL.	2200UF 25V 2200UF 25V 2200UF 25V	1.010.021.23 < WASHER PAPER 4.3 X7.5 X1 UNTERLAGSCHEIBE HP 4.3 X7.5 X1 RONDELLE PAPIER 4.3 X7.5 X1	
59.22.6220 < CAPACITOR EL. KONDENSATOR EL. CONDENSATEUR EL.	22UF 40V 22UF 40V 22UF 40V	1.010.059.21 < OVAL HEAD SCREW TORX M4 X14 LINSENZYL.SCHR.TORX BLK M4 X14 VIS BOMBEE TORX BLK M4 X14	
59.22.6470 < CAPACITOR EL. KONDENSATOR EL. CONDENSATEUR EL.	47UF 40V 47UF 40V 47UF 40V	1.721.490.01 < AUDIO PCB PRINT AUDIO CARTE AUDIO	
59.22.8100 < CAPACITOR EL. KONDENSATOR EL. CONDENSATEUR EL.	10UF 63V 10UF 63V 10UF 63V	1.721.490.02 < TAPE TRANSPORT LAUFWERK MECANISME	
59.22.8221 < CAPACITOR EL. KONDENSATOR EL. CONDENSATEUR EL.	220UF 63V 220UF 63V 220UF 63V	1.721.490.03 < MAINS TRANSFORMER NETZTRANSFORMATOR TRANSFO.ALIMENTATION	
59.22.8229 < CAPACITOR EL. KONDENSATOR EL. CONDENSATEUR EL.	2.2UF 50V 2.2UF 50V 2.2UF 50V	1.721.490.18 < IC MOTOR CONTROL IC MOTORREGELUNG CI REGULATEUR MOTEUR	
59.22.8479 < CAPACITOR EL. KONDENSATOR EL. CONDENSATEUR EL.	4.7UF 63V 4.7UF 63V 4.7UF 63V	1.721.490.19 < IC +5V REGULATOR IC +5V REGELUNG CI REGULATEUR +5V	
59.40.0103 < CAPACITOR KONDENSATOR CONDENSATEUR	10NF 10NF 10NF	1.721.490.21 < DISPLAY ANZEIGE AFFICHAGE	
59.41.2221 E	59.22.4221	1.721.490.24 < MICROPROCESSOR MIKROPROZESSOR MICROPROCESSEUR	
59.41.3101 E	59.22.5101	1.721.490.27 < KNOB DREHKNOPF BOUTON	
59.41.4221 E	59.22.4221	1.721.520.08 < ROCKER / EJECT BUTTON WIPPE / AUSLÖSEKNOB BASCULE RENVOI/TOUCHE EJECT	
		1.721.600.00 < AUDIO PCB PRINT AUDIO CARTE AUDIO	

- 1.721.600.01 < POTMETER 100K
POTENTIOMETRE 100K
- 1.721.720.01 < FRONT PANEL
FRONTPLATTE
PLAQUE FRONTALE
- 1.721.720.02 < FRONT PROFILE TOP SECTION
FRONTPROFIL OBEN
PROFIL FRONTALE SUPERIEUR
- 1.721.720.03 < GLASS PANEL
GLASSSCHEIBE
FENETRE
- 1.721.720.04 < GUIDE / PUSHBUTTON
TASTENFUEHRUNG
GUIDE DE TOUCHE
- 1.721.720.05 < PUSHBUTTON EJECT
AUSLOESETASTE
TOUCHE EJECT
- 1.721.720.07 < EXTENSION / PUSHBUTTON
TASTENVERLAENGERUNG
RALLONGE DE TOUCHE
- 1.721.720.14 < WEDGE RIGHT
ABSCHLUSSTEIL RECHTS
MONTANT DROIT
- 1.721.720.15 < WEDGE LEFT
ABSCHLUSSTEIL LINKS
MONTANT GAUCHE
- 1.721.720.19 < BUTTON
STECKWELLE
- 1.721.720.20 < KNOB
DREHKNOPF
BOUTON
- 1.721.720.25 < FRONT ..
TUERBLLENDE
- 1.721.790.05 < PUSHBUTTON SWITCH 2X A
DRUCKTASTENSCHALTER 2X A
INTERRUPTEUR POUSSOIRE 2X A
- 1.747.500.05 < FOOT
FUSS
PIED
- C115 / 25.05.92
C115
BR.

1.721.750.00 MAINS UNIT C115

Ad	..Pos..	...Ref.No...	Description
C.....2	59.14.3222	2.2 nF	20%, 440VAC, Y	
C.....3	59.14.3222	2.2 nF	20%, 440VAC, Y	
F.....1	51.01.0112	T315mA	Fuse	
MP....1	1.721.750.11		Mains Unit PCB	
MP....2	53.03.0145		Fuseholder	
MP....3	1.726.780.01		Holder	
MP....4	28.21.2405		Tubular Rivet	
MP....5	1.721.750.01	2 pcs	Holder	
MP....6	28.21.2408	2 pcs	Tubular Rivet	
P.....1	54.42.0020		Mains Connector	
S.....2	55.17.1000		Mains Switch	
W.....1	1.721.490.10		Jumper Lead 8-pole	
W.....2	1.721.750.93		Wire List	

00 PS 91/10/03

END

1.721.760.00 POWER SUPPLY C 115 ESE

Ad	..Pos..	...Ref.No...	Description
C.....1	59.22.6100	10 uF	-20%, 35V, EL	
C.....2	59.22.6100	10 uF	-20%, 35V, EL	
C.....3	59.22.6100	10 uF	-20%, 35V, EL	
C.....4	59.22.6100	10 uF	-20%, 35V, EL	
C.....5	59.06.0224	220 nF	10%, 63V, PETP	
C.....6	59.06.0104	100 nF	10%, 63V, PETP	
C.....7	59.06.0104	100 nF	10%, 63V, PETP	
C.....8	59.22.4471	470 uF	-20%, 16V, EL	
C.....9	59.22.5222	2.2 mF	-20%, 25V, EL	
C.....10	59.22.5222	2.2 mF	-20%, 25V, EL	
C.....11	59.22.4472	4.7 mF	-20%, 16V, EL	
C.....12	59.22.5472	4.7 mF	-20%, 25V, EL	
C.....13	59.06.0104	100 nF	10%, 63V, PETP	
C.....14	59.06.0104	100 nF	10%, 63V, PETP	
C.....15	59.22.8221	220 uF	-20%, 63V, EL	
C.....16	59.22.8229	2.2 uF	-20%, 63V, EL	
C.....17	59.22.8479	4.7 uF	-20%, 63V, EL	
C.....18	59.06.0223	22 nF	10%, 63V, PETP	
C.....19	59.06.0103	10 nF	10%, 63V, PETP	
D.....1	50.04.0105	1N 4004	SI	any
D.....2	50.04.0105	1N 4004	SI	any
D.....3	50.04.0105	1N 4004	SI	any
D.....4	50.04.0105	1N 4004	SI	any
D.....5	50.04.0105	1N 4004	SI	any
D.....6	50.04.0105	1N 4004	SI	any
D.....7	50.04.0105	1N 4004	SI	any
D.....8	50.04.0105	1N 4004	SI	any
D.....9	50.04.0105	1N 4004	SI	any
D.....10	50.04.0105	1N 4004	SI	any
D.....11	50.04.0105	1N 4004	SI	any
D.....12	50.04.0105	1N 4004	SI	any
D.....13	50.04.0105	1N 4004	SI	any
D.....14	50.04.0105	1N 4004	SI	any
D.....15	50.04.0105	1N 4004	SI	any
D.....16	50.04.0105	1N 4004	SI	any
D.....17	50.04.0105	1N 4004	SI	any
D.....18	50.04.0105	1N 4004	SI	any
D.....19	50.04.0105	1N 4004	SI	any
D.....20	50.04.0133	BAV 20	SI	any
D.....21	50.04.0133	BAV 20	SI	any
D.....22	50.04.0125	1N 4448	SI	any
D.....23	50.04.0125	1N 4448	SI	any
D.....24	50.04.0125	1N 4448	SI	any
D.....25	50.04.0105	1N 4004	SI	any
D.....26	50.04.0105	1N 4004	SI	any
D.....27	50.04.0125	1N 4448	SI	any
DV....1	50.04.1103	7.5 V	5%, 0.50W	any
DV....2	50.04.1112	5.1 V	5%, 0.50W	any
DV....3	50.04.1103	7.5 V	5%, 0.50W	any
DV....4	50.04.1123	4.7 V	5%, 0.50W	any
F.....1	51.01.0114	T500mA	Fuse	
IC....1	50.10.0104	LM 317T	+1.2-37 V, 1.5A, V-Reg.	NS, TI
IC....2	50.10.0105	LM 337T	-1.2-37 V, 1.5A, V-Reg.	NS, TI
IC....3	1.721.490.19	L78NR05	Voltage Regulator	
IC....4	1.721.490.18	BA6219	Motor Controller	
J.....1	1.721.490.07		Jack Jumper Socket 8-pole	
J.....2	54.12.0405		Socket 5-pol	
J.....3	1.721.490.08		Jack Jumper Socket 9-pole	
J.....4	1.721.490.09		Jack Flat Cable 17-pole	
MP....1	1.721.760.11		Power Supply PCB	
MP....2	1.746.220.04		Heatsink	
MP....3	1.746.220.06		Thermoplastic-foil	

MP....4	21.99.0180	2 pcs	Screw M3*5 rustless	
MP....5	50.20.2003	3 pcs	Clamp for TO 220 Case	
MP....6	53.03.0142	2 pcs	Fuseholder	
MP....7	1.721.490.12		Connective Cord 6-pole	
Q.....1	50.03.0515	BC 307B	Small Signal	PNP any
Q.....2	50.03.0515	BC 307B	Small Signal	PNP any
Q.....3	50.03.0436	BC 237B	Small Signal	NPN any
Q.....4	50.03.0436	BC 237B	Small Signal	NPN any
Q.....5	50.03.0436	BC 237B	Small Signal	NPN any
Q.....6	50.03.0436	BC 237B	Small Signal	NPN any
Q.....7	50.03.0504	BD 679	Darlington	NPN any
Q.....8	50.03.0504	BD 679	Darlington	NPN any
Q.....9	50.03.0436	BC 237B	Small Signal	NPN any
Q.....10	50.03.0436	BC 237B	Small Signal	NPN any
Q.....11	50.03.0436	BC 237B	Small Signal	NPN any
Q.....12	50.03.0515	BC 307B	Small Signal	PNP any
R.....1	57.11.3221	220 Ohm	1%, 0.25W, MF	
R.....2	57.11.3182	1.8 kOhm	1%, 0.25W, MF	
R.....3	57.11.3182	1.8 kOhm	1%, 0.25W, MF	
R.....4	57.11.3221	220 Ohm	1%, 0.25W, MF	
R.....5	57.19.0100	10 Ohm	0.33W, Fusible Resistor	
R.....6	57.19.0109	1 Ohm	0.33W, Fusible Resistor	
R.....7	57.19.0109	1 Ohm	0.33W, Fusible Resistor	
R.....8	57.19.0109	1 Ohm	0.33W, Fusible Resistor	
R.....9	57.19.0109	1 Ohm	0.33W, Fusible Resistor	
R.....10	57.19.0560	56 Ohm	0.33W, Fusible Resistor	
R.....11	57.19.0109	1 Ohm	0.33W, Fusible Resistor	
R.....12	57.19.0109	1 Ohm	0.33W, Fusible Resistor	
R.....13	57.19.0151	150 Ohm	0.33W, Fusible Resistor	
R.....14	57.19.0151	150 Ohm	0.33W, Fusible Resistor	
R.....15	57.11.3103	10 kOhm	1%, 0.25W, MF	
R.....16	57.11.3104	100 kOhm	1%, 0.25W, MF	
R.....17	57.11.3104	100 kOhm	1%, 0.25W, MF	
R.....18	57.11.3104	100 kOhm	1%, 0.25W, MF	
R.....19	57.11.3102	1 kOhm	1%, 0.25W, MF	
R.....20	57.11.3682	6.8 kOhm	1%, 0.25W, MF	
R.....21	57.11.3103	10 kOhm	1%, 0.25W, MF	
R.....22	57.11.3223	22 kOhm	1%, 0.25W, MF	
R.....23	57.11.3223	22 kOhm	1%, 0.25W, MF	
R.....24	57.11.3223	22 kOhm	1%, 0.25W, MF	
R.....25	57.11.3103	10 kOhm	1%, 0.25W, MF	
R.....26	57.11.3222	2.2 kOhm	1%, 0.25W, MF	
R.....27	57.11.3223	22 kOhm	1%, 0.25W, MF	
R.....28	57.11.3473	47 kOhm	1%, 0.25W, MF	
R.....29	57.11.3472	4.7 kOhm	1%, 0.25W, MF	
R.....30	57.11.3103	10 kOhm	1%, 0.25W, MF	
R.....32	57.11.3393	39 kOhm	1%, 0.25W, MF	
R.....33	57.11.3473	47 kOhm	1%, 0.25W, MF	
R.....34	57.11.3473	47 kOhm	1%, 0.25W, MF	
R.....35	57.11.3103	10 kOhm	1%, 0.25W, MF	
R.....36	57.11.3103	10 kOhm	1%, 0.25W, MF	
R.....37	57.11.3223	22 kOhm	1%, 0.25W, MF	
R.....38	57.11.3103	10 kOhm	1%, 0.25W, MF	
W.....4	1.721.760.94		Flat Cable	

00 PS 91/10/04

EL=Electrolytic, CER=Ceramic, PETP=Polyester, SI-Silicon, MF-Metalfilm

Manufacturer: NS-National Semiconductors, TI-Texas Instruments

MOT=Motorola, Ph=Philips, St=Studer, SGI=SGS Thomson

END

1.721.761.00 IN-OUT UNIT C115 ESE

Ad	Pos	Ref.No	Description
C.....1	59.22.6220	22 uF	-20% 35V EL
C.....2	59.22.6220	22 uF	-20% 35V EL
C.....3	59.06.0104	100 nF	10% 63V PETP
C.....4	59.06.0104	100 nF	10% 63V PETP
C.....5	59.22.3101	100 uF	-20% 10V EL
C.....6	59.22.3101	100 uF	-20% 10V EL
C.....7	59.22.3101	100 uF	-20% 10V EL
C.....8	59.22.3101	100 uF	-20% 10V EL
C.....9	59.06.0104	100 nF	10% 63V PETP
C.....10	59.06.0104	100 nF	10% 63V PETP
C.....11	59.34.4151	150 pF	10% 63V CER
C.....12	59.34.4271	270 pF	10% 63V CER
C.....13	59.32.4681	680 pF	20% 50V CER
C.....14	59.32.4681	680 pF	20% 50V CER
C.....15	59.06.0104	100 nF	10% 63V PETP
C.....16	59.06.0104	100 nF	10% 63V PETP
C.....17	59.32.4681	680 pF	20% 50V CER
C.....18	59.32.4681	680 pF	20% 50V CER
C.....19	59.34.4151	150 pF	10% 63V CER
C.....20	59.34.4271	270 pF	10% 63V CER
C.....21	59.05.1681	680 pF	1% 63V PP
C.....22	59.05.1681	680 pF	1% 63V PP
C.....23	59.34.4560	56 pF	10% 63V CER
C.....24	59.34.4560	56 pF	10% 63V CER
C.....25	59.05.1681	680 pF	1% 63V PP
C.....26	59.05.1681	680 pF	1% 63V PP
C.....27	59.22.8479	4.7 uF	-20% 25V EL
C.....28	59.06.0105	1 uF	10% 63V PETP
C.....29	59.06.0223	22 nF	10% 63V PETP
C.....30	59.22.5470	47 uF	-20% 25V EL
C.....31	59.22.2221	220 uF	-20% 6V EL
C.....32	59.22.2221	220 uF	-20% 6V EL
C.....33	59.22.2221	220 uF	-20% 6V EL
C.....34	59.22.2221	220 uF	-20% 6V EL
C.....35	59.06.0104	100 nF	10% 63V PETP
C.....36	59.06.0104	100 nF	10% 63V PETP
C.....37	59.06.0104	100 nF	10% 63V PETP
C.....38	59.06.0104	100 nF	10% 63V PETP
D.....1	50.04.0125	IN 4448	SI any
D.....2	50.04.0125	IN 4448	SI any
D.....3	50.04.0125	IN 4448	SI any
D.....4	50.04.0125	IN 4448	SI any
D.....5	50.04.0125	IN 4448	SI any
D.....6	50.04.0125	IN 4448	SI any
IC.....1	50.09.0105	NE 5532	Operational-Amplifier Sig
IC.....2	50.09.0105	NE 5532	Operational-Amplifier Sig
IC.....3	50.09.0105	NE 5532	Operational-Amplifier Sig
IC.....4	50.09.0105	NE 5532	Operational-Amplifier Sig
IC.....5	50.09.0105	NE 5532	Operational-Amplifier Sig
IC.....6	50.09.0126	4N 28	Optical Coupler NOT
IC.....7	50.17.1132	74 HC 132	2-Input Schmitt Trigger NAND Gate
J.....1	54.12.0405		Socket 5-pole
J.....2	54.12.0405		Socket 5-pole
J.....3	54.12.0403		Socket 3-pole
J.....4	54.21.2201		XLR-Socket 3-pole
J.....5	54.21.2201		XLR-Socket 3-pole
J.....6	54.20.2001		DIN-Socket 6-pole
JS.....1	54.01.0021		Jumper
JS.....2	54.01.0021		Jumper
L.....1	62.02.3479	4.7 uH	HF-Choke
MP.....1	1.721.761.11		In-Out PCB
MP.....2	1.726.780.01	2 pcs	Holder
MP.....3	28.21.2405	2 pcs	Tubular Rivet
MP.....4	20.21.7102	4 pcs	Screw 2.2 * 4.5mm
P.....1	54.01.0020		Contact-Pin
P.....2	54.01.0020		Contact-Pin
P.....3	54.01.0020		Contact-Pin
P.....4	54.01.0020		Contact-Pin
P.....5	54.01.0020		Contact-Pin
P.....6	54.01.0020		Contact-Pin
P.....7	54.21.2200		XLR-Socket 3-pole
P.....8	54.21.2200		XLR-Socket 3-pole
Q.....1	50.03.0350	J 112	N-Channel FET
Q.....2	50.03.0350	J 112	N-Channel FET
Q.....3	50.03.0350	J 112	N-Channel FET
Q.....4	50.03.0350	J 112	N-Channel FET
R.....1	57.11.3682	6.8 kOhm	1%, 0.25W, MF
R.....2	57.11.3272	2.7 kOhm	1%, 0.25W, MF
R.....3	57.11.3104	100 kOhm	1%, 0.25W, MF
R.....4	57.11.3105	1 MOhm	1%, 0.25W, MF
R.....5	57.11.3153	15 kOhm	1%, 0.25W, MF
R.....6	57.11.3564	560 kOhm	1%, 0.25W, MF
R.....7	57.11.3104	100 kOhm	1%, 0.25W, MF
R.....8	57.11.3105	1 MOhm	1%, 0.25W, MF
R.....9	57.11.3362	3.6 kOhm	1%, 0.25W, MF
R.....10	57.11.3152	1.5 kOhm	1%, 0.25W, MF
R.....11	57.11.3152	1.5 kOhm	1%, 0.25W, MF
R.....12	57.11.3362	3.6 kOhm	1%, 0.25W, MF
R.....13	57.11.3105	1 MOhm	1%, 0.25W, MF
R.....14	57.11.3564	560 kOhm	1%, 0.25W, MF
R.....15	57.11.3153	15 kOhm	1%, 0.25W, MF
R.....16	57.11.3105	1 MOhm	1%, 0.25W, MF
R.....17	57.11.3272	2.7 kOhm	1%, 0.25W, MF
R.....18	57.11.3682	6.8 kOhm	1%, 0.25W, MF
R.....19	57.11.3302	3 kOhm	1%, 0.25W, MF
R.....20	57.11.3302	3 kOhm	1%, 0.25W, MF
R.....21	57.11.3150	15 Ohm	1%, 0.25W, MF
R.....22	57.11.3302	3 kOhm	1%, 0.25W, MF
R.....23	57.11.3150	15 Ohm	1%, 0.25W, MF
R.....24	57.11.3689	6.8 Ohm	1%, 0.25W, MF
R.....25	57.11.3689	6.8 Ohm	1%, 0.25W, MF
R.....26	57.11.3302	3 kOhm	1%, 0.25W, MF
R.....27	57.11.3302	3 kOhm	1%, 0.25W, MF
R.....28	57.11.3302	3 kOhm	1%, 0.25W, MF
R.....29	57.11.3302	3 kOhm	1%, 0.25W, MF
R.....30	57.11.3152	1.5 kOhm	1%, 0.25W, MF
R.....31	57.11.3302	3 kOhm	1%, 0.25W, MF
R.....32	57.11.3152	1.5 kOhm	1%, 0.25W, MF
R.....33	57.11.3302	3 kOhm	1%, 0.25W, MF
R.....34	57.11.3302	3 kOhm	1%, 0.25W, MF
R.....35	57.11.3302	3 kOhm	1%, 0.25W, MF
R.....36	57.11.3150	15 Ohm	1%, 0.25W, MF
R.....37	57.11.3302	3 kOhm	1%, 0.25W, MF
R.....38	57.11.3150	15 Ohm	1%, 0.25W, MF
R.....39	57.11.3689	6.8 Ohm	1%, 0.25W, MF
R.....40	57.11.3689	6.8 Ohm	1%, 0.25W, MF
R.....41	57.11.3302	3 kOhm	1%, 0.25W, MF
R.....42	57.11.3302	3 kOhm	1%, 0.25W, MF
R.....43	57.11.3302	3 kOhm	1%, 0.25W, MF
R.....44	57.11.3302	3 kOhm	1%, 0.25W, MF
R.....45	57.11.3152	1.5 kOhm	1%, 0.25W, MF
R.....46	57.11.3302	3 kOhm	1%, 0.25W, MF
R.....47	57.11.3152	1.5 kOhm	1%, 0.25W, MF
R.....48	57.11.3302	3 kOhm	1%, 0.25W, MF
R.....49	57.11.3152	1.5 kOhm	1%, 0.25W, MF
R.....50	57.11.3152	1.5 kOhm	1%, 0.25W, MF
R.....51	57.11.3392	3.9 kOhm	1%, 0.25W, MF
R.....52	57.11.3272	2.7 kOhm	1%, 0.25W, MF
R.....53	57.11.3392	3.9 kOhm	1%, 0.25W, MF
R.....54	57.11.3272	2.7 kOhm	1%, 0.25W, MF
R.....55	57.11.3272	2.7 kOhm	1%, 0.25W, MF
R.....56	57.11.3392	3.9 kOhm	1%, 0.25W, MF
R.....57	57.11.3392	3.9 kOhm	1%, 0.25W, MF
R.....58	57.11.3152	1.5 kOhm	1%, 0.25W, MF
R.....59	57.11.3152	1.5 kOhm	1%, 0.25W, MF
R.....60	57.11.3272	2.7 kOhm	1%, 0.25W, MF
R.....61	57.11.3561	560 Ohm	1%, 0.25W, MF
R.....62	57.11.3272	2.7 kOhm	1%, 0.25W, MF
R.....63	57.11.3104	100 kOhm	1%, 0.25W, MF
R.....64	57.11.3102	1 kOhm	1%, 0.25W, MF
R.....65	57.11.3104	100 kOhm	1%, 0.25W, MF
R.....66	57.11.3102	1 kOhm	1%, 0.25W, MF
R.....80	57.11.3302	3 kOhm	1%, 0.25W, MF
R.....81	57.11.3302	3 kOhm	1%, 0.25W, MF
R.....82	57.11.3302	3 kOhm	1%, 0.25W, MF
R.....83	57.11.3302	3 kOhm	1%, 0.25W, MF
R.....84	57.11.3302	3 kOhm	1%, 0.25W, MF
R.....85	57.11.3302	3 kOhm	1%, 0.25W, MF
S.....1	55.12.0003		Switch

00 PS 91/10/04

EL=Electrolytic, CER=Ceramic, PETP=Polyester, SI=Silicon, MF=Metalfilm
PP=PolypropilenManufacturer: NS=National Semiconductors, TI=Texas Instruments
MOT=Motorola, Ph=Philips, St=Studer, SGT=SGS Thomson
Sig=Signetics

END

1.721.790.00 FRONT UNIT C115 ESE

Ad	..Pos..	...Ref.No...	Description
C.....1		59.32.1102	1 nF
C.....2		59.22.8479	4.7 uF
C.....3		59.22.8479	4.7 uF
C.....4		59.22.8229	2.2 uF
C.....5		59.22.8479	4.7 uF
C.....6		59.22.4221	220 uF
C.....7		59.06.0152	1.5 nF
C.....8		59.34.5561	560 pF
C.....9		59.34.5561	560 pF
C.....10		59.22.8229	2.2 uF
D.....1		50.04.0125	1N 4448
D.....2		50.04.0125	1N 4448
DL.....1		50.04.2702	MV 53123, LED yellow
DL.....2		50.04.2701	MV 57123, LED red
DL.....3		50.04.2703	MV 54123, LED green
DV.....1		50.04.1145	9.1 V
IC.....1		1.721.490.24	MB 885158 Microprocessor
J.....1		1.721.490.06	Jack Flat Cable 17-pole
J.....2		1.721.490.06	Jack Flat Cable 17-pole
NP.....1		1.721.790.11	FRONT UNIT PCB
NP.....2		1.721.490.21	VF-Display
NP.....3		1.721.490.22	Display Holder
NP.....4		1.721.490.23	Sticker
NP.....5		1.721.490.29	Connective Cord 5-pole
NP.....6		53.03.0364	IC-Socket 64-pole
NP.....7		50.20.2799	3 pcs LED-Holder 1-13.7
Q.....1		50.03.0436	BC237B Small Signal
Q.....2		50.03.0436	BC237B Small Signal
Q.....3		50.03.0515	BC307B Small Signal
Q.....4		50.03.0436	BC237B Small Signal
Q.....5		50.03.0515	BC307B Small Signal
Q.....6		50.03.0436	BC237B Small Signal
Q.....7		50.03.0436	BC237B Small Signal
Q.....8		50.03.0351	BC327-25 Small Signal
Q.....9		50.03.0351	BC327-25 Small Signal
Q.....10		50.03.0515	BC307B Small Signal
Q.....11		50.03.0436	BC237B Small Signal
Q.....12		50.03.0515	BC307B Small Signal
Q.....13		50.03.0436	BC237B Small Signal
Q.....14		50.03.0436	BC237B Small Signal
Q.....15		50.03.0515	BC307B Small Signal
R.....1		57.11.3223	22 kOhm 2%, 0.25W, MF
R.....2		57.11.3223	22 kOhm 2%, 0.25W, MF
R.....3		57.11.3471	470 Ohm 2%, 0.25W, MF
R.....4		57.11.3223	22 kOhm 2%, 0.25W, MF
R.....5		57.11.3223	22 kOhm 2%, 0.25W, MF
R.....6		57.11.3222	2.2 kOhm 2%, 0.25W, MF
R.....7		57.11.3473	47 kOhm 2%, 0.25W, MF
R.....8		57.11.3223	22 kOhm 2%, 0.25W, MF
R.....9		57.11.3223	22 kOhm 2%, 0.25W, MF
R.....10		57.11.3222	2.2 kOhm 2%, 0.25W, MF
R.....11		57.11.3223	22 kOhm 2%, 0.25W, MF
R.....12		57.11.3471	470 Ohm 2%, 0.25W, MF
R.....13		57.11.3471	470 Ohm 2%, 0.25W, MF
R.....14		57.11.3223	22 kOhm 2%, 0.25W, MF
R.....15		57.11.3103	10 kOhm 2%, 0.25W, MF
R.....16		57.11.3103	10 kOhm 2%, 0.25W, MF
R.....17		57.11.3103	10 kOhm 2%, 0.25W, MF
R.....18		57.11.3103	10 kOhm 2%, 0.25W, MF
R.....19		57.11.3473	47 kOhm 2%, 0.25W, MF
R.....20		57.11.3222	2.2 kOhm 2%, 0.25W, MF
R.....21		57.11.3105	1 MOhm 2%, 0.25W, MF
R.....22		57.11.3222	2.2 kOhm 2%, 0.25W, MF
R.....23		57.11.3222	2.2 kOhm 2%, 0.25W, MF
R.....24		57.11.3103	10 kOhm 2%, 0.25W, MF
R.....25		57.11.3103	10 kOhm 2%, 0.25W, MF
R.....26		57.11.3102	1 kOhm 2%, 0.25W, MF
R.....27		57.11.3102	1 kOhm 2%, 0.25W, MF
R.....28		57.11.3473	47 kOhm 2%, 0.25W, MF
R.....29		57.11.3223	22 kOhm 2%, 0.25W, MF
R.....30		57.11.3223	22 kOhm 2%, 0.25W, MF
R.....31		57.11.3102	1 kOhm 2%, 0.25W, MF
R.....32		57.11.3102	1 kOhm 2%, 0.25W, MF
R.....33		57.11.3102	1 kOhm 2%, 0.25W, MF
R.....34		57.11.3102	1 kOhm 2%, 0.25W, MF
R.....35		57.11.3223	22 kOhm 2%, 0.25W, MF
R.....36		57.11.3223	22 kOhm 2%, 0.25W, MF
R.....37		57.11.3682	6.8 kOhm 2%, 0.25W, MF
R.....38		57.11.3473	47 kOhm 2%, 0.25W, MF
R.....39		57.11.3473	47 kOhm 2%, 0.25W, MF
R.....40		57.11.3473	47 kOhm 2%, 0.25W, MF
R.....41		57.11.3473	47 kOhm 2%, 0.25W, MF
R.....42		57.11.3102	1 kOhm 2%, 0.25W, MF
R.....43		57.11.3102	1 kOhm 2%, 0.25W, MF
R.....44		57.11.3102	1 kOhm 2%, 0.25W, MF
R.....45		57.11.3102	1 kOhm 2%, 0.25W, MF
R.....46		57.11.3102	1 kOhm 2%, 0.25W, MF
R.....47		57.11.3102	1 kOhm 2%, 0.25W, MF
R.....48		57.11.3102	1 kOhm 2%, 0.25W, MF
R.....49		57.11.3102	1 kOhm 2%, 0.25W, MF
R.....50		57.11.3102	1 kOhm 2%, 0.25W, MF
R.....51		57.11.3102	1 kOhm 2%, 0.25W, MF
R.....52		57.11.3471	470 Ohm 2%, 0.25W, MF
R.....53		57.11.3102	1 kOhm 2%, 0.25W, MF
R.....54		57.11.3222	2.2 kOhm 2%, 0.25W, MF
R.....55		57.11.3471	470 Ohm 2%, 0.25W, MF
R.....56		57.11.3473	47 kOhm 2%, 0.25W, MF
R.....57		57.11.3473	47 kOhm 2%, 0.25W, MF
R.....58		57.11.3222	2.2 kOhm 2%, 0.25W, MF
R.....59		57.11.3222	2.2 kOhm 2%, 0.25W, MF
R.....60		57.11.3222	2.2 kOhm 2%, 0.25W, MF
R.....61		57.11.3223	22 kOhm 2%, 0.25W, MF
R.....62		57.11.3223	22 kOhm 2%, 0.25W, MF
R.....63		57.11.3473	47 kOhm 2%, 0.25W, MF
R.....64		57.11.3473	47 kOhm 2%, 0.25W, MF
R.....65		57.11.3103	10 kOhm 2%, 0.25W, MF
R.....66		57.11.3103	10 kOhm 2%, 0.25W, MF
R.....67		57.11.3223	22 kOhm 2%, 0.25W, MF
R.....68		57.11.3222	2.2 kOhm 2%, 0.25W, MF
R.....69		57.11.3683	68 kOhm 2%, 0.25W, MF
R.....70		57.11.3683	68 kOhm 2%, 0.25W, MF
RZ.....1		57.88.4473	47 kOhm 2%, 8*0.125W
RZ.....2		57.88.4473	47 kOhm 2%, 8*0.125W
RZ.....3		57.88.4473	47 kOhm 2%, 8*0.125W
RZ.....4		57.88.4473	47 kOhm 2%, 8*0.125W
S.....1		55.99.0158	1* ^a
S.....2		55.99.0158	1* ^a
S.....3		55.99.0158	1* ^a
S.....4		55.99.0158	1* ^a
S.....5		55.99.0158	1* ^a
S.....6		55.99.0158	1* ^a
S.....7		55.99.0158	1* ^a
S.....8		55.99.0158	1* ^a
S.....9		55.99.0158	1* ^a
S.....10		1.721.790.05	2* ^u
S.....11		1.721.790.05	2* ^u
S.....12		1.721.790.05	2* ^u
S.....13		55.99.0158	1* ^a
S.....14		55.99.0158	1* ^a
S.....15		55.99.0158	1* ^a
S.....16		55.99.0158	1* ^a
W.....5		1.721.790.94	Flat Cable
Y.....1		1.721.490.25	CERAMIC OSCILLATOR 6.0 MHz

00 PS 91/10/04

EL=Electrolytic, CER=Ceramic, PETP=Polyester, SI=Silicon, MF=Metalfilm

Manufacturer: NS-National Semiconductors, TI-Texas Instruments
MOT-Motorola, Ph-Philips, St-Studer, SGT-SGS Thomson

REVOX C115

PROFESSIONAL CASSETTE TAPE DECK

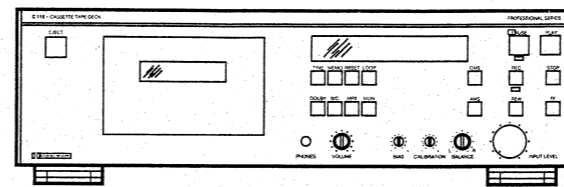

SCHEMATIC DIAGRAM
BLOCK DIAGRAM
CONNECTION DIAGRAM
PARTS LOCATION (Components Side)

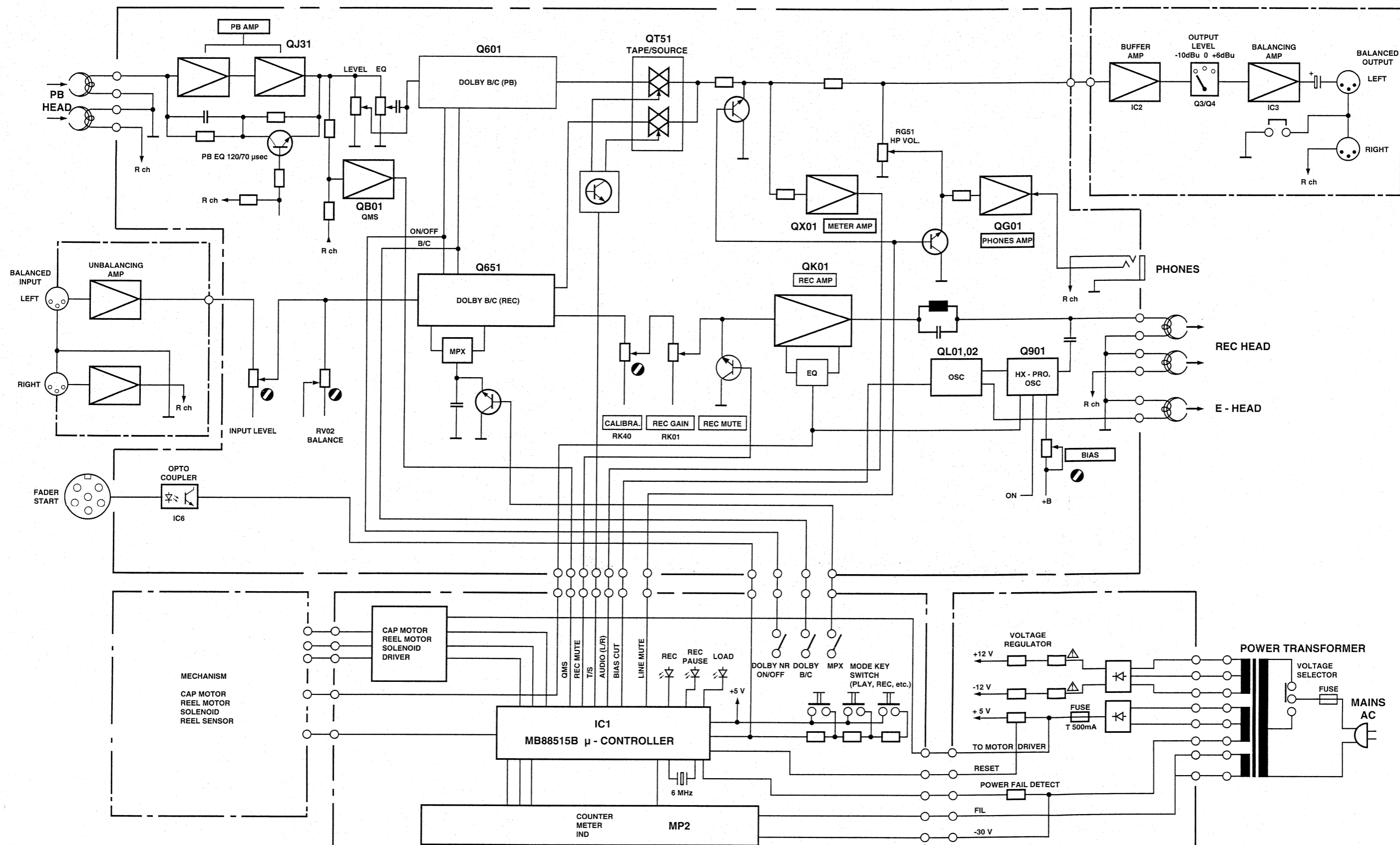

Block Diagram

Block Diagram

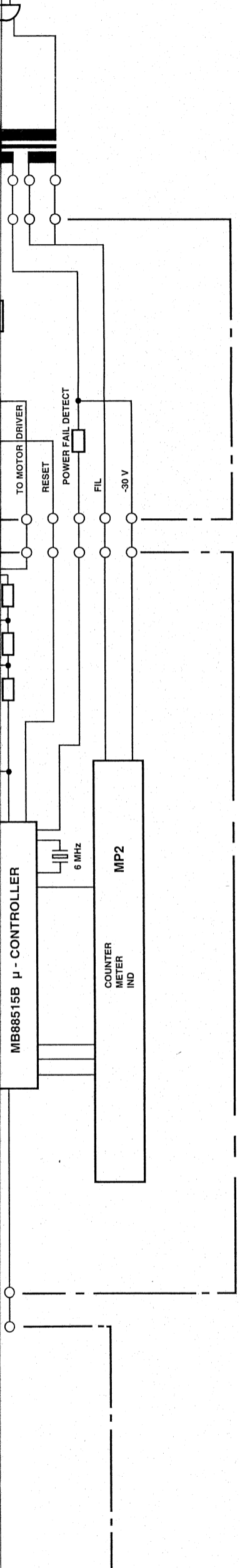

Connection Diagram

Parts Location (Components Side)

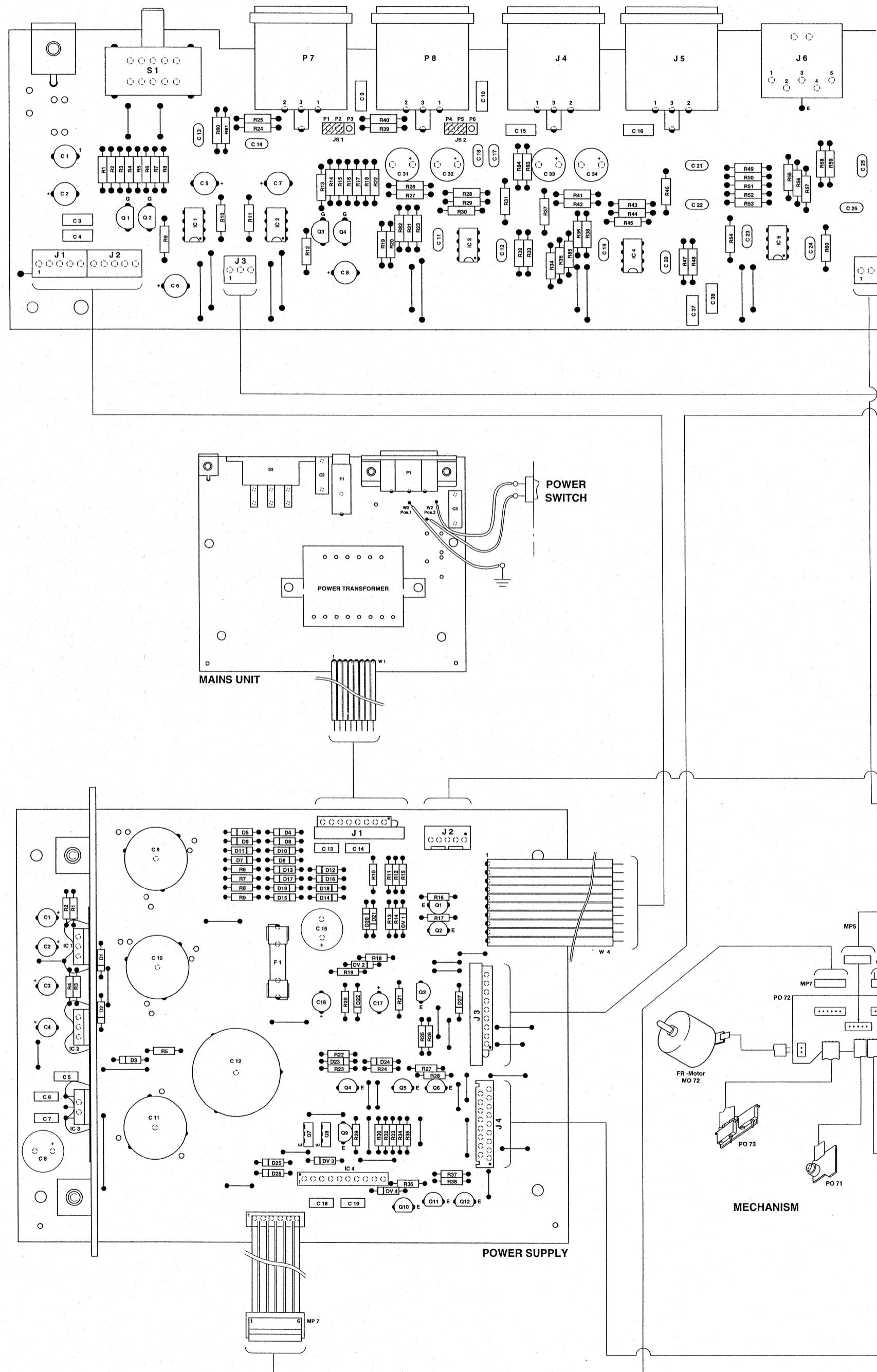

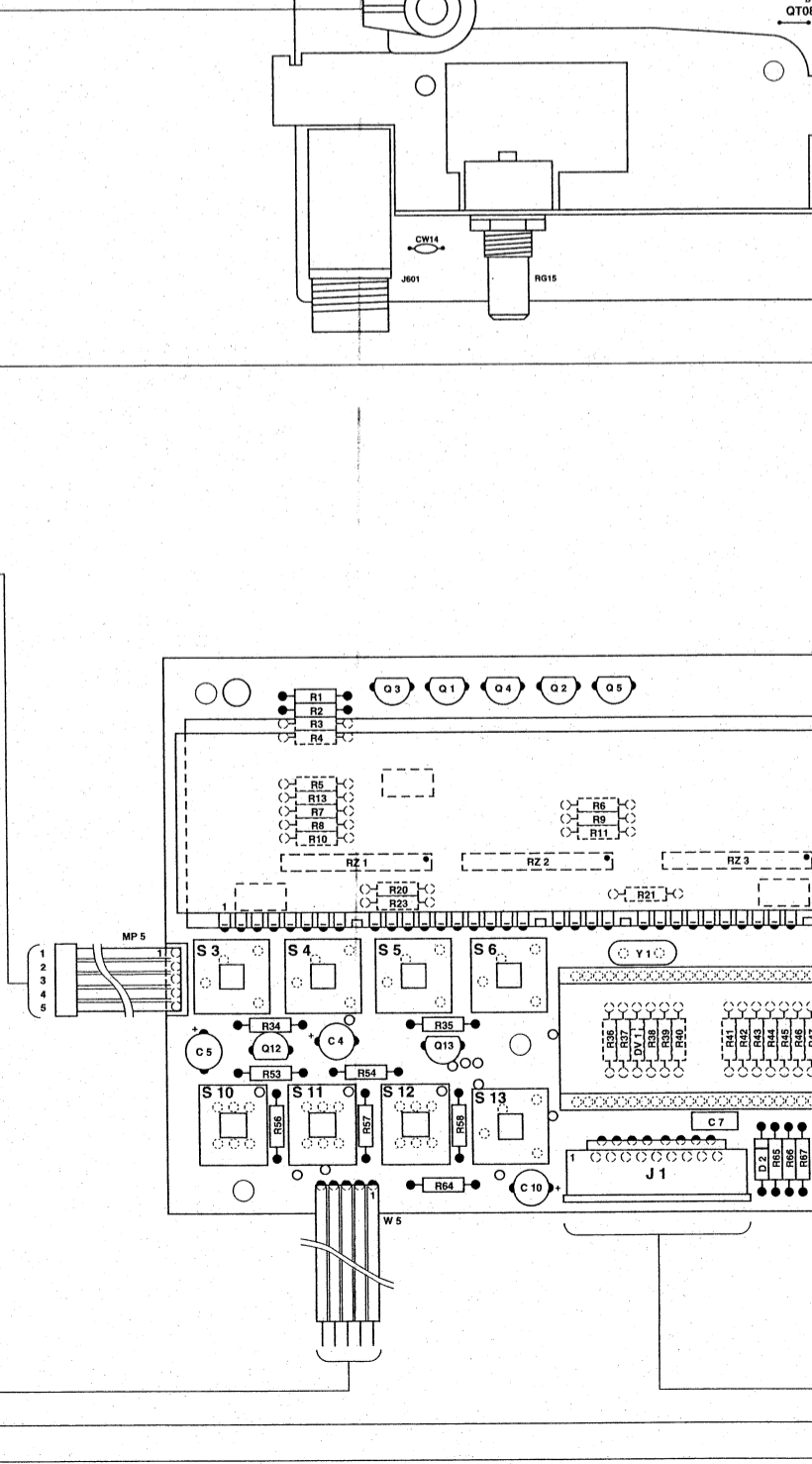
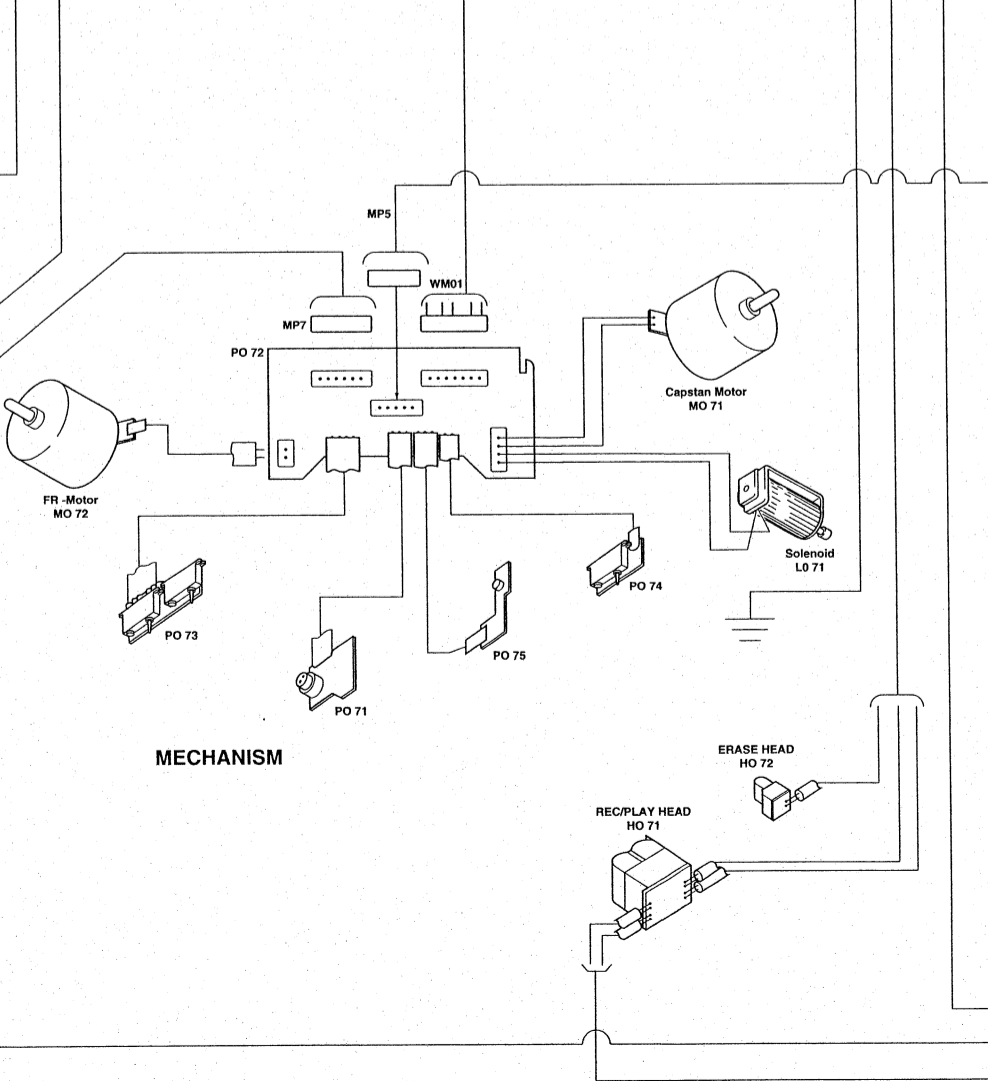
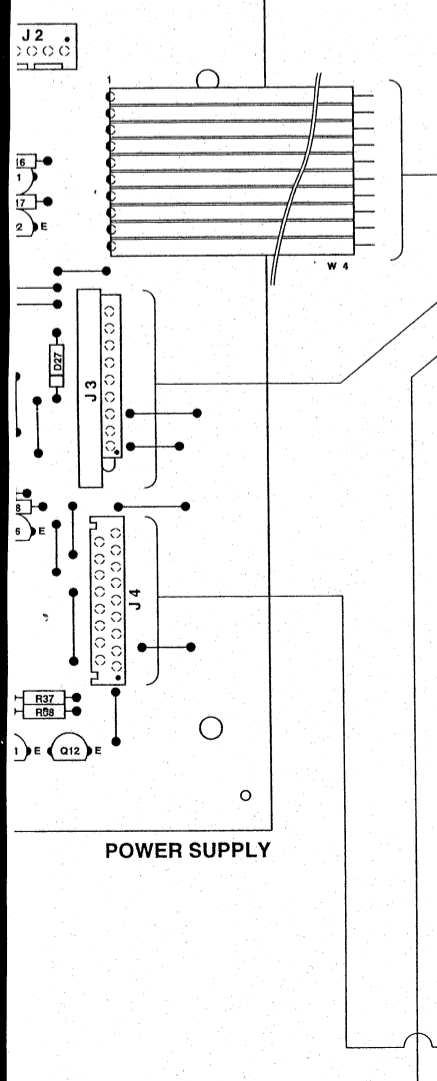
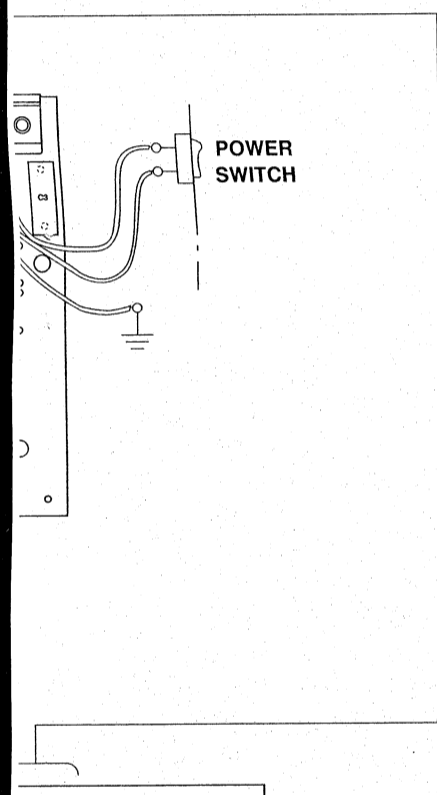
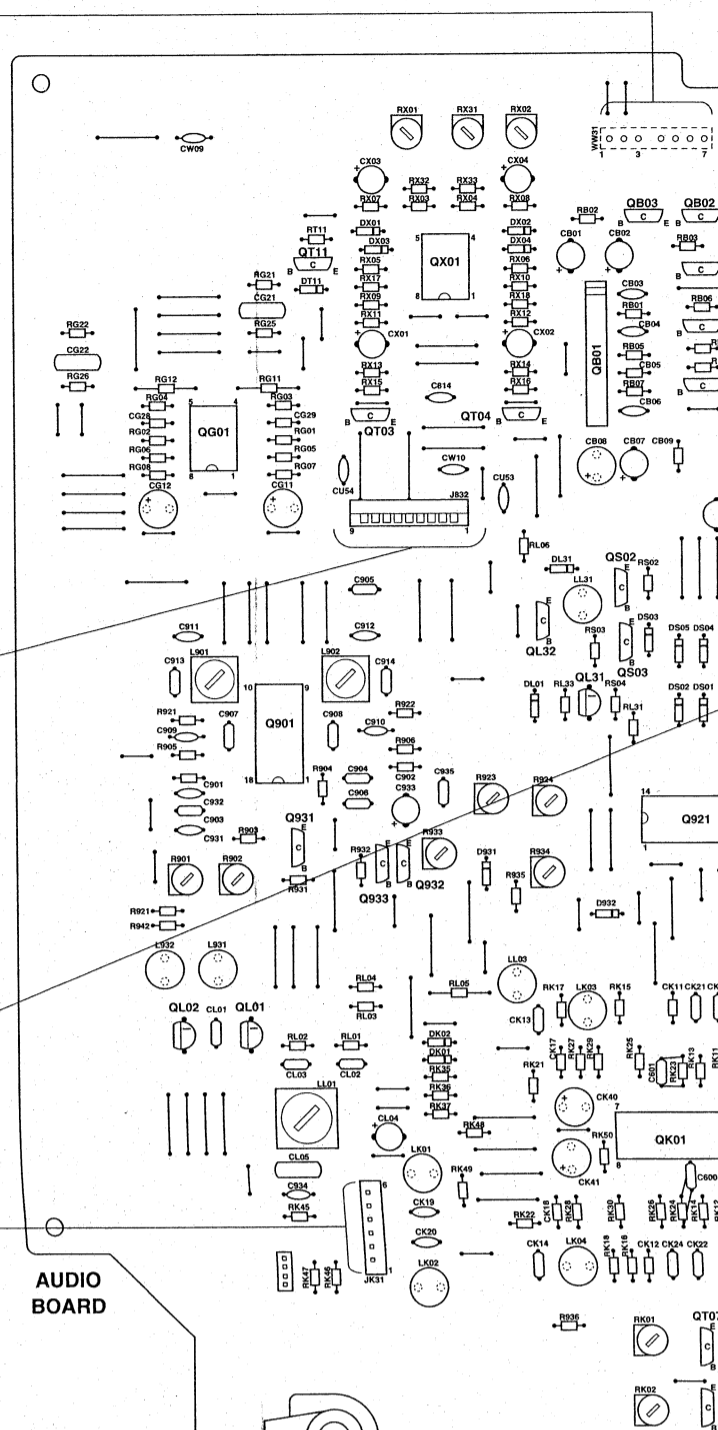
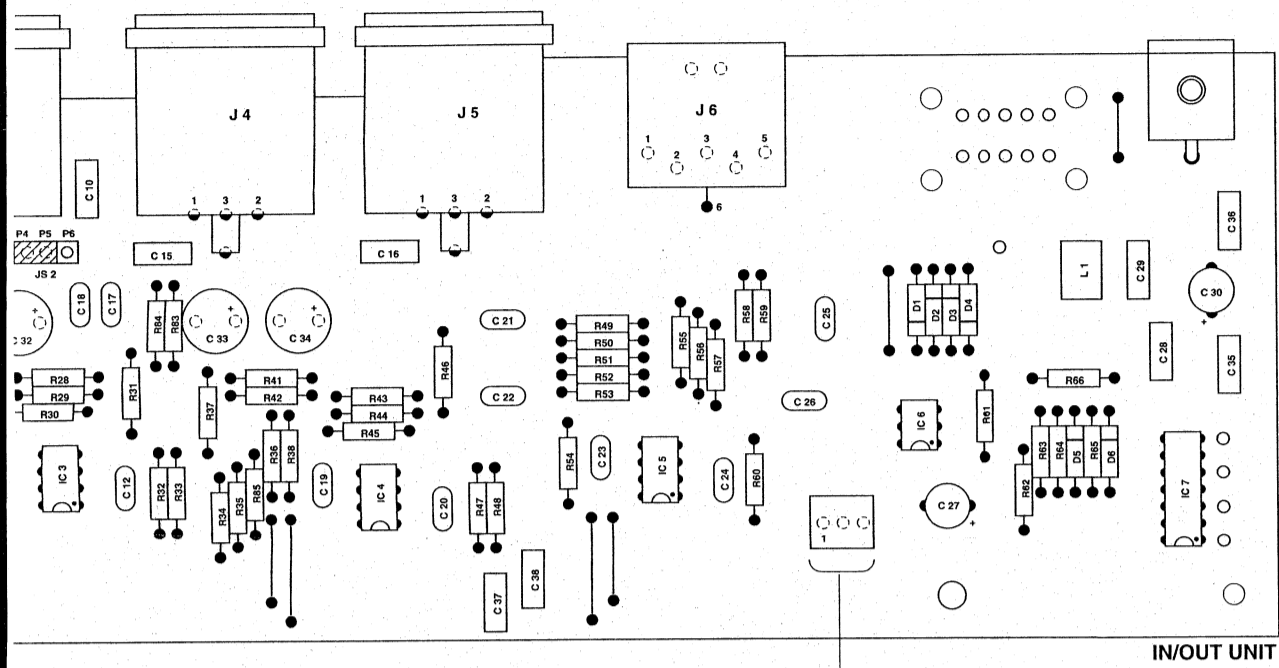

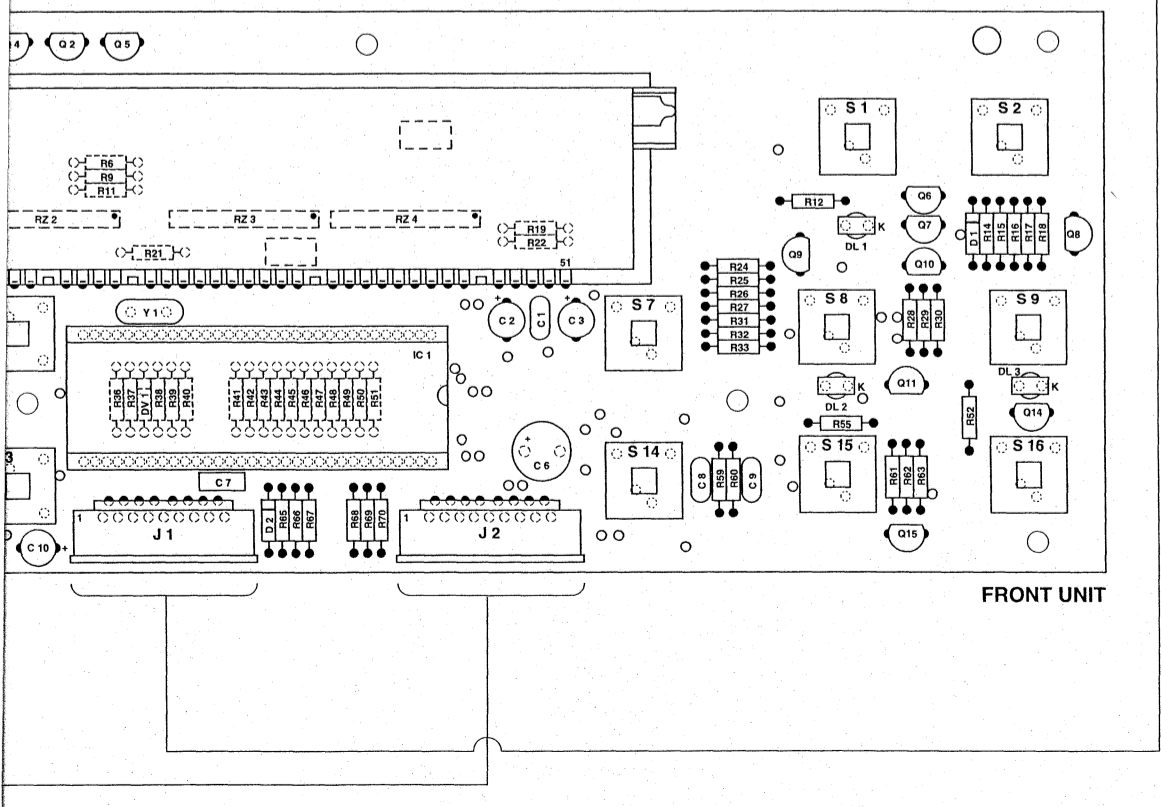
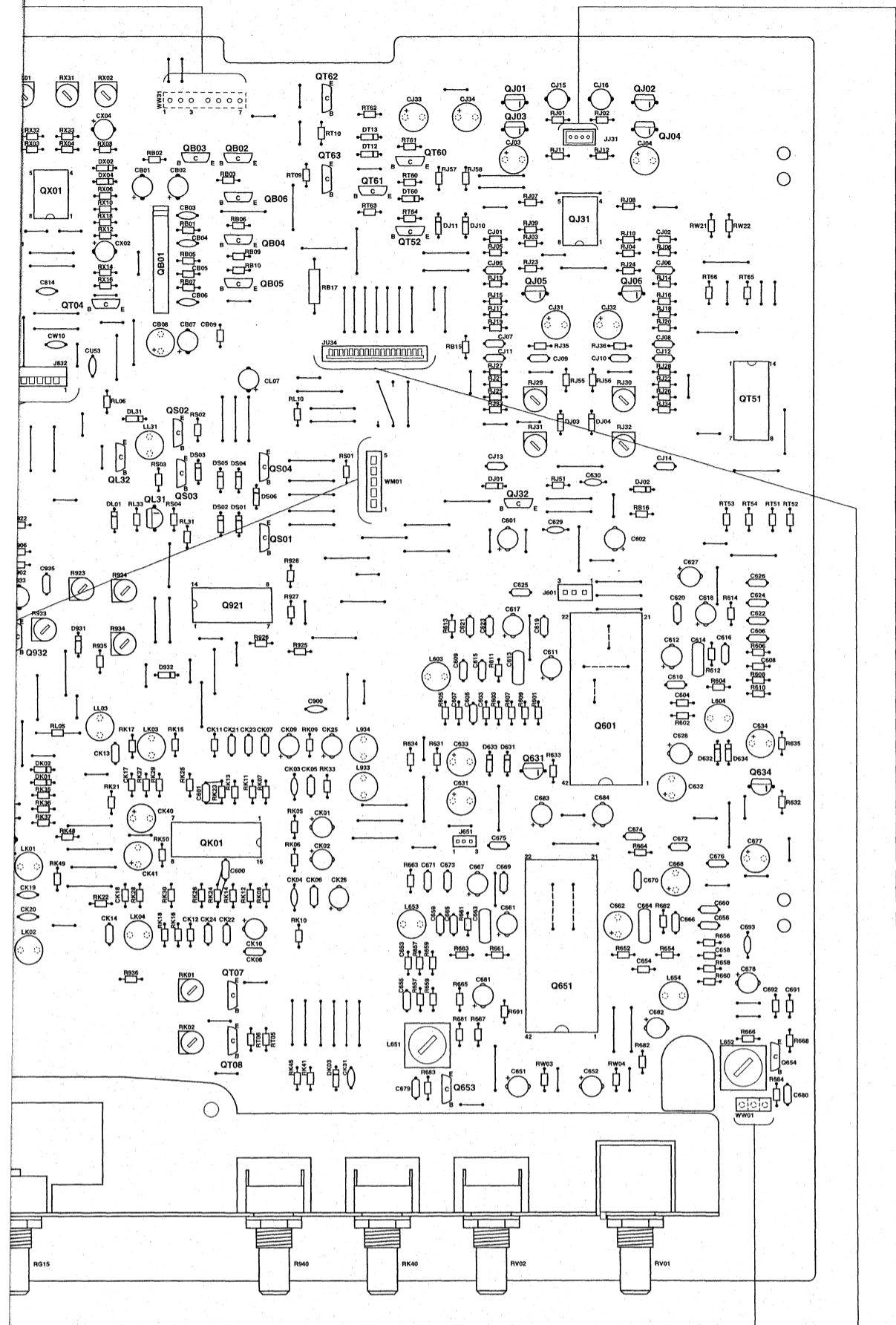

FRONT UNIT

1.721.600.00 AUDIO BOARD 1/2

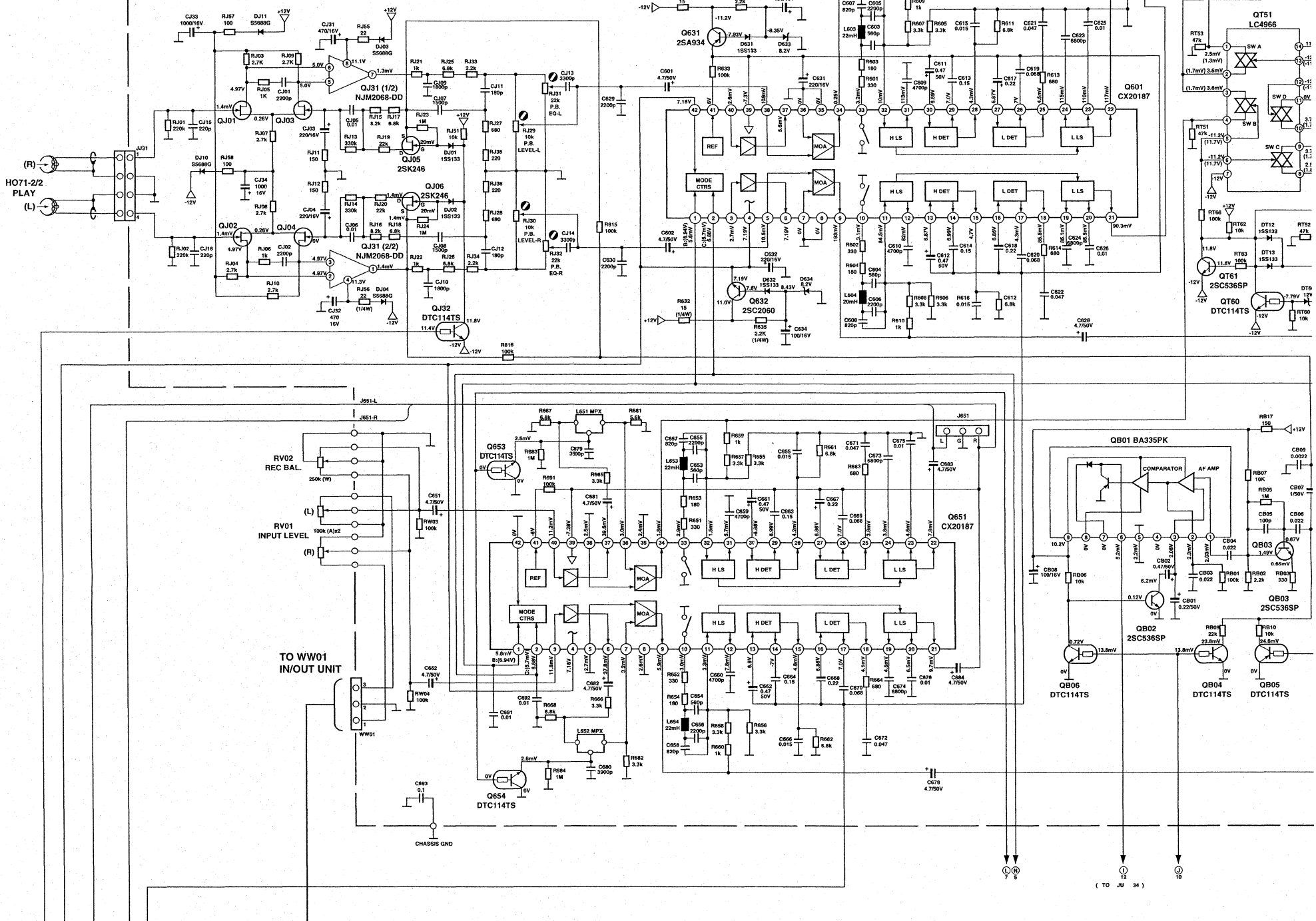

1.721.600.00 2/2 AUDIO BOARD

